

## SN74AHC541-Q1 Octal Buffer/Driver with 3-State Outputs

### 1 Features

- Qualified for automotive applications
- Operating range of 2 V to 5.5 V  $V_{CC}$
- Latch-Up performance exceeds 250 mA per JESD 17

### 2 Applications

- [Enable or Disable a Digital Signal](#)
- [Eliminate Slow or Noisy Input Signals](#)
- [Hold a Signal During Controller Reset](#)
- [Debounce a Switch](#)

### 3 Description

The SN74AHC541 octal buffer/driver is ideal for driving bus lines or buffer memory address registers. This device features inputs and outputs on opposite sides of the package to facilitate printed circuit board layout.

#### Package Information

PART NUMBER	PACKAGE <sup>(1)</sup>	BODY SIZE (NOM)
SN74AHC541-Q1	PW (TSSOP, 20)	6.5 mm × 4.4 mm

(1) For all available packages, see the orderable addendum at the end of the data sheet.

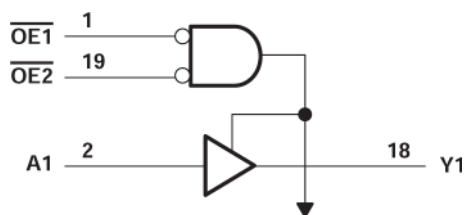

To Seven Other Channels  
**Logic Diagram (Positive Logic)**



## Table of Contents

<b>1 Features</b> .....	1	8.1 Overview.....	8
<b>2 Applications</b> .....	1	8.2 Functional Block Diagram.....	8
<b>3 Description</b> .....	1	8.3 Device Functional Modes.....	8
<b>4 Revision History</b> .....	2	<b>9 Application and Implementation</b> .....	9
<b>5 Pin Configuration and Functions</b> .....	3	9.1 Power Supply Recommendations.....	9
<b>6 Specifications</b> .....	4	9.2 Layout.....	9
6.1 Absolute Maximum Ratings.....	4	<b>10 Device and Documentation Support</b> .....	11
6.2 Recommended Operating Conditions.....	4	10.1 Document Support (Analog).....	11
6.3 Thermal Information.....	5	10.2 Receiving Notification of Documentation Updates..	11
6.4 Electrical Characteristics.....	5	10.3 Support Resources.....	11
6.5 Switching Characteristics, $V_{CC} = 3.3\text{ V} \pm 0.3\text{ V}$ .....	5	10.4 Trademarks.....	11
6.6 Switching Characteristics, $V_{CC} = 5\text{ V} \pm 0.5\text{ V}$ .....	6	10.5 Electrostatic Discharge Caution.....	11
6.7 Noise Characteristics.....	6	10.6 Glossary.....	11
6.8 Operating Characteristics.....	6	<b>11 Mechanical, Packaging, and Orderable Information</b> .....	11
<b>7 Parameter Measurement Information</b> .....	7		
<b>8 Detailed Description</b> .....	8		

## 4 Revision History

NOTE: Page numbers for previous revisions may differ from page numbers in the current version.

Changes from Revision A (April 2008) to Revision B (April 2023)	Page
• Added <i>Applications</i> , <i>Package Information</i> table, <i>Pin Functions</i> table, <i>ESD Ratings</i> table, <i>Thermal Information</i> table, <i>Device Functional Modes</i> , <i>Application and Implementation</i> section, <i>Power Supply Recommendations</i> section, <i>Layout</i> section, <i>Device and Documentation Support</i> section, and <i>Mechanical, Packaging, and Orderable Information</i> section.....	1

## 5 Pin Configuration and Functions

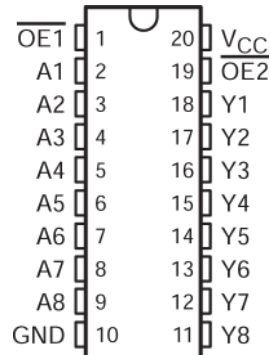

**Figure 5-1. D or PW Package (Top View)**

**Table 5-1. Pin Functions**

PIN		I/O	DESCRIPTION
NAME	NO.		
OE1	1	I	Output Enable 1
A1	2	I	A1 Input
A2	3	I	A2 Input
A3	4	I	A3 Input
A4	5	I	A4 Input
A5	6	I	A5 Input
A6	7	I	A6 Input
A7	8	I	A7 Input
A8	9	I	A8 Input
GND	10	—	Ground
Y8	11	O	Y8 Output
Y7	12	O	Y7 Output
Y6	13	O	Y6 Output
Y5	14	O	Y5 Output
Y4	15	O	Y4 Output
Y3	16	O	Y3 Output
Y2	17	O	Y2 Output
Y1	18	O	Y1 Output
OE2	19	I	Output Enable 2
V <sub>CC</sub>	20	—	Power Pin

## 6 Specifications

### 6.1 Absolute Maximum Ratings

over operating free-air temperature range (unless otherwise noted)<sup>1</sup>

		MIN	MAX	UNIT
$V_{CC}$	Supply voltage range	-0.5	7	V
$V_I$ <sup>2</sup>	Input voltage range	-0.5	7	V
$V_O$ <sup>2</sup>	Output voltage range	-0.5	$V_{CC} + 0.5$	V
$I_{IK}$ ( $V_I < 0$ )	Input clamp current		-20	mA
$I_{OK}$ ( $V_O < 0$ or $V_O > V_{CC}$ )	Output clamp current		$\pm 20$	mA
$I_O$ ( $V_O = 0$ to $V_{CC}$ )	Continuous output current		$\pm 25$	mA
	Continuous current through $V_{CC}$ or GND		$\pm 75$	mA
$T_{stg}$	Storage temperature range	-65	150	°C

- Stresses beyond those listed under “absolute maximum ratings” may cause permanent damage to the device. These are stress ratings only, and functional operation of the device at these or any other conditions beyond those indicated under “recommended operating conditions” is not implied. Exposure to absolute-maximum-rated conditions for extended periods may affect device reliability.
- The input and output voltage ratings may be exceeded if the input and output current ratings are observed.

### 6.2 Recommended Operating Conditions

(see Note<sup>1</sup>)

			MIN	MAX	UNIT
$V_{CC}$	Supply voltage		2	5.5	V
$V_{IH}$	High-level input voltage	$V_{CC} = 2$ V	1.5		V
		$V_{CC} = 3$ V	2.1		
		$V_{CC} = 5.5$ V	3.85		
$V_{IL}$	Low-level input voltage	$V_{CC} = 2$ V		0.5	V
		$V_{CC} = 3$ V		0.9	
		$V_{CC} = 5.5$ V		1.65	
$V_I$	Input voltage		0	5.5	V
$V_O$	Output voltage		0	$V_{CC}$	V
$I_{OH}$	High-level output current	$V_{CC} = 2$ V		-50	mA
		$V_{CC} = 3.3$ V $\pm$ 0.3 V		-4	mA
		$V_{CC} = 5$ V $\pm$ 0.5 V		-8	
$I_{OL}$	Low-level output current	$V_{CC} = 2$ V		50	mA
		$V_{CC} = 3.3$ V $\pm$ 0.3 V		4	mA
		$V_{CC} = 5$ V $\pm$ 0.5 V		8	
$\Delta t/\Delta v$	Input transition rise or fall rate	$V_{CC} = 3.3$ V $\pm$ 0.3 V		100	ns/V
		$V_{CC} = 5$ V $\pm$ 0.5 V		20	
$T_A$	Operating free-air temperature		-40	125	°C

- All unused inputs of the device must be held at  $V_{CC}$  or GND to ensure proper device operation. Refer to the TI application report, *Implications of Slow or Floating CMOS Inputs*, literature number SCBA004.

### 6.3 Thermal Information

THERMAL METRIC <sup>(1)</sup>		SN74AHC541-Q1		UNIT
		DW (SOIC)	PW (TSSOP)	
		20 PINS	20 PINS	
R <sub>θJA</sub>	Junction-to-ambient thermal resistance	58	83	°C/W

(1) For more information about traditional and new thermal metrics, see the *IC Package Thermal Metrics* application report, (SPRA953).

### 6.4 Electrical Characteristics

over recommended operating free-air temperature range (unless otherwise noted)

PARAMETER	TEST CONDITIONS	V <sub>CC</sub>	T <sub>A</sub> = 25°C			T <sub>A</sub> = -40°C TO 125°C		T <sub>A</sub> = -40°C TO 85°C		UNIT
			MIN	TYP	MAX	MIN	MAX	MIN	MAX	
V <sub>OH</sub>	I <sub>OH</sub> = -50 mA	2 V	1.9	2		1.9		1.9	V	
		3 V	2.9	3		2.9		2.9		
		4.5 V	4.4	4.5		4.4		4.4		
	I <sub>OH</sub> = -4 mA	3 V	2.58			2.48		2.48		
	I <sub>OH</sub> = -8 mA	4.5 V	3.94			3.8		3.8		
V <sub>OL</sub>	I <sub>OL</sub> = 50 mA	2 V			0.1		0.1		V	
		3 V			0.1		0.1			
		4.5 V			0.1		0.1			
	I <sub>OL</sub> = 4 mA	3 V			0.36		0.5	0.44		
	I <sub>OL</sub> = 8 mA	4.5 V			0.36		0.5	0.44		
I <sub>I</sub>	V <sub>I</sub> = 5.5 V or GND	0 V to 5.5 V			±0.1		±1		±1	μA
I <sub>OZ</sub> <sup>(1)</sup>	V <sub>O</sub> = V <sub>CC</sub> or GND, V <sub>I</sub> ( $\overline{OE}$ ) = V <sub>IL</sub> or V <sub>IH</sub>	5.5 V			±0.25		±2.5		±2.5	μA
I <sub>CC</sub>	V <sub>I</sub> = V <sub>CC</sub> or GND, I <sub>O</sub> = 0	5.5 V			4		40		40	μA
C <sub>i</sub>	V <sub>I</sub> = V <sub>CC</sub> or GND	5 V		2	10				10	pF
C <sub>o</sub>	V <sub>O</sub> = V <sub>CC</sub> or GND	5 V		4						pF

(1) For input and output, I<sub>OZ</sub> includes the input leakage current.

### 6.5 Switching Characteristics, V<sub>CC</sub> = 3.3 V ± 0.3 V

over recommended operating free-air temperature range, V<sub>CC</sub> = 3.3 V ± 0.3 V (unless otherwise noted) (see Figure 7-1)

PARAMETER	FROM (INPUT)	TO (OUTPUT)	LOAD CAPACITANCE	T <sub>A</sub> = 25°C			T <sub>A</sub> = -40°C TO 125°C		T <sub>A</sub> = -40°C TO 85°C		UNIT
				MIN	TYP	MAX	MIN	MAX	MIN	MAX	
t <sub>PLH</sub>	A	Y	C <sub>L</sub> = 15 pF	5	7		1	8.5	1	8.5	ns
t <sub>PHL</sub>				5	7		1	8.5	1	8.5	
t <sub>PZH</sub>	$\overline{OE}$	Y	C <sub>L</sub> = 15 pF	6	10.5		1	11	1	11	ns
t <sub>PZL</sub>				6	10.5		1	11	1	11	
t <sub>PHZ</sub>	$\overline{OE}$	Y	C <sub>L</sub> = 15 pF	7	11		1	12	1	12	ns
t <sub>PLZ</sub>				7	11		1	12	1	12	
t <sub>PLH</sub>	A	Y	C <sub>L</sub> = 50 pF	7.5	10.5		1	12	1	12	ns
t <sub>PHL</sub>				7.5	10.5		1	12	1	12	
t <sub>PZH</sub>	$\overline{OE}$	Y	C <sub>L</sub> = 50 pF	8	14		1	16	1	16	ns
t <sub>PZL</sub>				8	14		1	16	1	16	
t <sub>PHZ</sub>	$\overline{OE}$	Y	C <sub>L</sub> = 50 pF	9	15.4		1	17.5	1	17.5	ns
t <sub>PLZ</sub>				9	15.4		1	17.5	1	17.5	

**SN74AHC541-Q1**

SCLS603B – DECEMBER 2004 – REVISED APRIL 2023

 over recommended operating free-air temperature range,  $V_{CC} = 3.3\text{ V} \pm 0.3\text{ V}$  (unless otherwise noted) (see Figure 7-1)

PARAMETER	FROM (INPUT)	TO (OUTPUT)	LOAD CAPACITANCE	$T_A = 25^\circ\text{C}$			$T_A = -40^\circ\text{C TO } 125^\circ\text{C}$		$T_A = -40^\circ\text{C TO } 85^\circ\text{C}$		UNIT
				MIN	TYP	MAX	MIN	MAX	MIN	MAX	
tsk(o)			$C_L = 50\text{ pF}$			1.5				1.5	ns

**6.6 Switching Characteristics,  $V_{CC} = 5\text{ V} \pm 0.5\text{ V}$** 

 over recommended operating free-air temperature range,  $V_{CC} = 5\text{ V} \pm 0.5\text{ V}$  (unless otherwise noted) (see Figure 7-1)

PARAMETER	FROM (INPUT)	TO (OUTPUT)	LOAD CAPACITANCE	$T_A = 25^\circ\text{C}$			$T_A = -40^\circ\text{C TO } 125^\circ\text{C}$		$T_A = -40^\circ\text{C TO } 85^\circ\text{C}$		UNIT
				MIN	TYP	MAX	MIN	MAX	MIN	MAX	
$t_{PLH}$	A	Y	$C_L = 15\text{ pF}$		3.5	5	1	6	1	6	ns
$t_{PHL}$					3.5	5	1	6	1	6	
$t_{PZH}$	$\overline{\text{OE}}$	Y	$C_L = 15\text{ pF}$		4.7	7.2	1	8.5	1	8.5	ns
$t_{PZL}$					4.7	7.2	1	8.5	1	8.5	
$t_{PHZ}$	$\overline{\text{OE}}$	Y	$C_L = 15\text{ pF}$		5	7.5	1	8	1	8	ns
$t_{PLZ}$					5	7.5	1	8	1	8	
$t_{PLH}$	A	Y	$C_L = 50\text{ pF}$		5	7	1	8	1	8	ns
$t_{PHL}$					5	7	1	8	1	8	
$t_{PZH}$	$\overline{\text{OE}}$	Y	$C_L = 50\text{ pF}$		6.2	9.2	1	10.5	1	10.5	ns
$t_{PZL}$					6.2	9.2	1	10.5	1	10.5	
$t_{PHZ}$	$\overline{\text{OE}}$	Y	$C_L = 50\text{ pF}$		6	8.8	1	10	1	10	ns
$t_{PLZ}$					6	8.8	1	10	1	10	
tsk(o)			$C_L = 50\text{ pF}$			1			1	ns	

**6.7 Noise Characteristics**
 $V_{CC} = 5\text{ V}$ ,  $C_L = 50\text{ pF}$ ,  $T_A = 25^\circ\text{C}$  <sup>1)</sup>

PARAMETER		MIN	MAX	UNIT
$V_{OL(P)}$	Quiet output, maximum dynamic $V_{OL}$		0.8	V
$V_{OL(V)}$	Quiet output, minimum dynamic $V_{OL}$		-0.8	V
$V_{OH(V)}$	Quiet output, minimum dynamic $V_{OH}$	4.7		V
$V_{IH(D)}$	High-level dynamic input voltage	3.5		V
$V_{IL(D)}$	Low-level dynamic input voltage		1.5	V

(1) Characteristics are for surface-mount packages only.

**6.8 Operating Characteristics**
 $V_{CC} = 5\text{ V}$ ,  $T_A = 25^\circ\text{C}$ 

PARAMETER		TEST CONDITIONS	TYP	UNIT
$C_{pd}$	Power dissipation capacitance	No load, $f = 1\text{ MHz}$	12	pF

## 7 Parameter Measurement Information

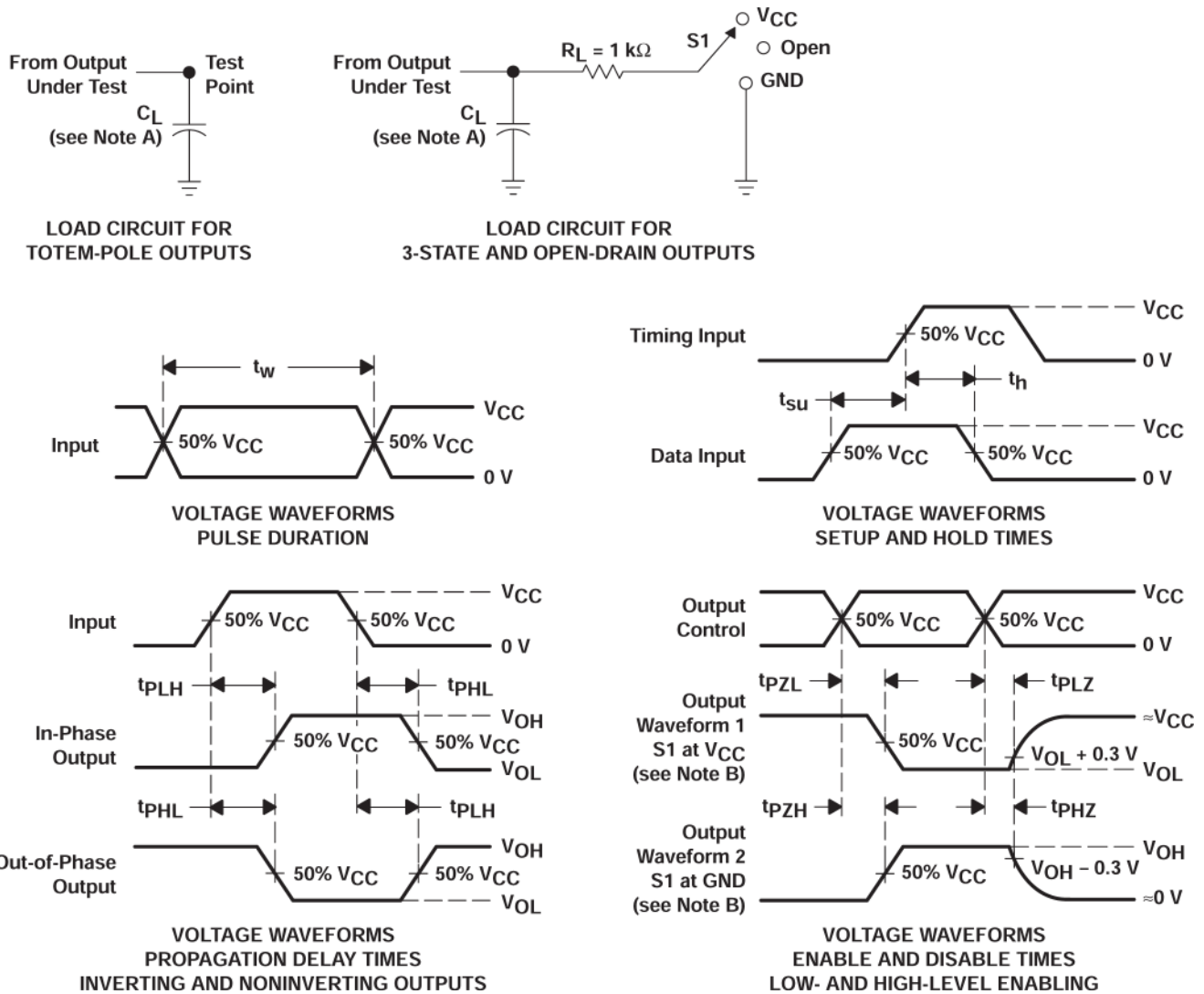

- A.  $C_L$  includes probe and jig capacitance.
- B. Waveform 1 is for an output with internal conditions such that the output is low, except when disabled by the output control. Waveform 2 is for an output with internal conditions such that the output is high, except when disabled by the output control.
- C. All input pulses are supplied by generators having the following characteristics:  $PRR \leq 1$  MHz,  $Z_O = 50 \Omega$ ,  $t_r \leq 3$  ns,  $t_f \leq 3$  ns.
- D. The outputs are measured one at a time, with one input transition per measurement.
- E. All parameters and waveforms are not applicable to all devices.

Figure 7-1. Load Circuit and Voltage Waveforms

TEST	S1
$t_{PLH}/t_{PHL}$	Open
$t_{PLZ}/t_{PZL}$	$V_{CC}$
$t_{PHZ}/t_{PZH}$	GND
Open Drain	$V_{CC}$

## 8 Detailed Description

### 8.1 Overview

The 3-state control gate is a two-input AND gate with active-low inputs so that if either output-enable ( $\overline{OE1}$  or  $\overline{OE2}$ ) input is high, all corresponding outputs are in the high-impedance state. The outputs provide noninverted data when they are not in the high-impedance state.

To ensure the high-impedance state during power up or power down,  $\overline{OE}$  should be tied to  $V_{CC}$  through a pullup resistor; the minimum value of the resistor is determined by the current-sinking capability of the driver.

### 8.2 Functional Block Diagram

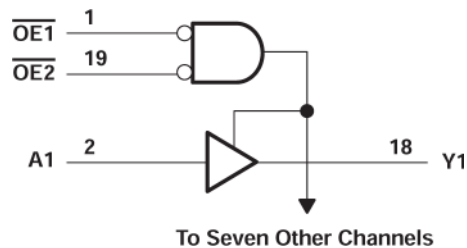

Figure 8-1. Logic Diagram (Positive Logic)

### 8.3 Device Functional Modes

Table 8-1. (Each Buffer/Driver)

INPUTS			OUTPUT
$\overline{OE1}$	$\overline{OE2}$	A	Y
L	L	L	L
L	L	H	H
H	X	X	Z
X	H	X	Z



## 9 Application and Implementation

---

### Note

Information in the following applications sections is not part of the TI component specification, and TI does not warrant its accuracy or completeness. TI's customers are responsible for determining suitability of components for their purposes, as well as validating and testing their design implementation to confirm system functionality.

---

### 9.1 Power Supply Recommendations

The power supply can be any voltage between the MIN and MAX supply voltage rating located in the [Recommended Operating Conditions](#) table.

Each  $V_{CC}$  pin should have a good bypass capacitor to prevent power disturbance. For devices with a single supply, 0.1  $\mu\text{F}$  is recommended. If there are multiple  $V_{CC}$  pins, 0.01  $\mu\text{F}$  or 0.022  $\mu\text{F}$  is recommended for each power pin. It is acceptable to parallel multiple bypass caps to reject different frequencies of noise. A 0.1  $\mu\text{F}$  and 1  $\mu\text{F}$  are commonly used in parallel. The bypass capacitor should be installed as close to the power pin as possible for best results.

### 9.2 Layout

#### 9.2.1 Layout Guidelines

When using multiple bit logic devices inputs should not ever float.

In many cases, functions or parts of functions of digital logic devices are unused, for example, when only two inputs of a triple-input AND gate are used or only 3 of the 4 buffer gates are used. Such input pins should not be left unconnected because the undefined voltages at the outside connections result in undefined operational states. Specified in [Layout Diagram](#) are the rules that must be observed under all circumstances. All unused inputs of digital logic devices must be connected to a high or low bias to prevent them from floating. The logic level that should be applied to any particular unused input depends on the function of the device. Generally they will be tied to GND or  $V_{CC}$ ; whichever makes more sense or is more convenient. It is generally acceptable to float outputs unless the part is a transceiver. If the transceiver has an output enable pin, it will disable the outputs section of the part when asserted. This will not disable the input section of the IOs, so they cannot float when disabled.

**9.2.1.1 Layout Example**

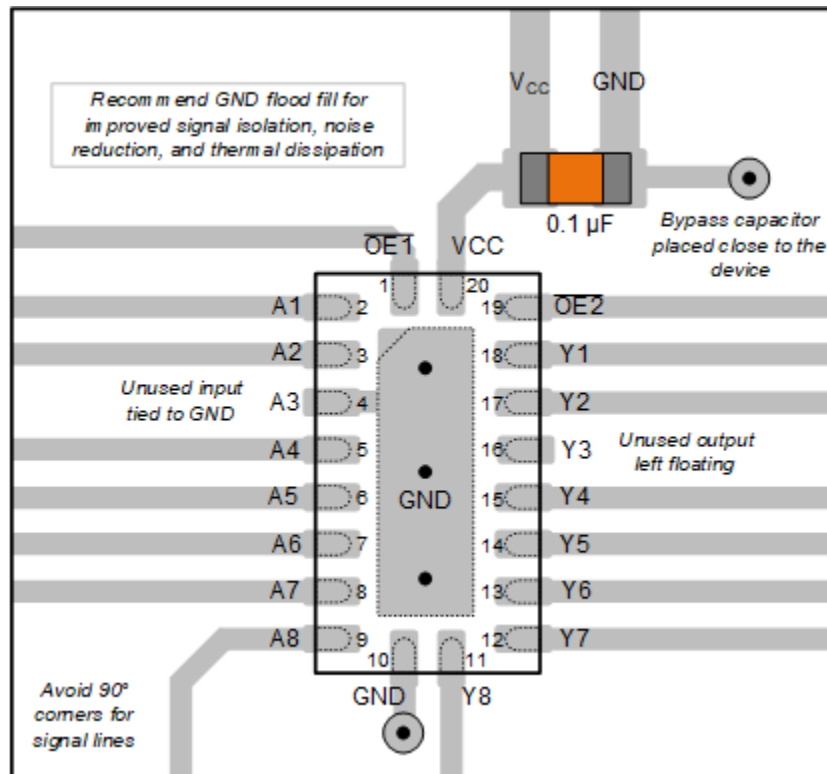

**Figure 9-1. Layout Diagram**

## 10 Device and Documentation Support

### 10.1 Document Support (Analog)

#### 10.1.1 Related Documentation

The table below lists quick access links. Categories include technical documents, support and community resources, tools and software, and quick access to sample or buy.

**Table 10-1. Related Links**

PARTS	PRODUCT FOLDER	SAMPLE & BUY	TECHNICAL DOCUMENTS	TOOLS & SOFTWARE	SUPPORT & COMMUNITY
SN74AHC541-Q1	<a href="#">Click here</a>	<a href="#">Click here</a>	<a href="#">Click here</a>	<a href="#">Click here</a>	<a href="#">Click here</a>

### 10.2 Receiving Notification of Documentation Updates

To receive notification of documentation updates, navigate to the device product folder on [ti.com](http://ti.com). Click on *Subscribe to updates* to register and receive a weekly digest of any product information that has changed. For change details, review the revision history included in any revised document.

### 10.3 Support Resources

[TI E2E™ support forums](#) are an engineer's go-to source for fast, verified answers and design help — straight from the experts. Search existing answers or ask your own question to get the quick design help you need.

Linked content is provided "AS IS" by the respective contributors. They do not constitute TI specifications and do not necessarily reflect TI's views; see TI's [Terms of Use](#).

### 10.4 Trademarks

TI E2E™ is a trademark of Texas Instruments.  
All trademarks are the property of their respective owners.

### 10.5 Electrostatic Discharge Caution



This integrated circuit can be damaged by ESD. Texas Instruments recommends that all integrated circuits be handled with appropriate precautions. Failure to observe proper handling and installation procedures can cause damage.

ESD damage can range from subtle performance degradation to complete device failure. Precision integrated circuits may be more susceptible to damage because very small parametric changes could cause the device not to meet its published specifications.

### 10.6 Glossary

[TI Glossary](#) This glossary lists and explains terms, acronyms, and definitions.

## 11 Mechanical, Packaging, and Orderable Information

The following pages include mechanical, packaging, and orderable information. This information is the most current data available for the designated devices. This data is subject to change without notice and revision of this document. For browser-based versions of this data sheet, refer to the left-hand navigation.

**PACKAGING INFORMATION**

Orderable Device	Status (1)	Package Type	Package Drawing	Pins	Package Qty	Eco Plan (2)	Lead finish/ Ball material (6)	MSL Peak Temp (3)	Op Temp (°C)	Device Marking (4/5)	Samples
SN74AHC541QPWRG4Q1	ACTIVE	TSSOP	PW	20	2000	RoHS & Green	NIPDAU	Level-1-260C-UNLIM	-40 to 125	AHC541Q	Samples
SN74AHC541QPWRQ1	ACTIVE	TSSOP	PW	20	2000	RoHS & Green	NIPDAU	Level-1-260C-UNLIM	-40 to 125	AHC541Q	Samples

(1) The marketing status values are defined as follows:

**ACTIVE:** Product device recommended for new designs.

**LIFEBUY:** TI has announced that the device will be discontinued, and a lifetime-buy period is in effect.

**NRND:** Not recommended for new designs. Device is in production to support existing customers, but TI does not recommend using this part in a new design.

**PREVIEW:** Device has been announced but is not in production. Samples may or may not be available.

**OBSOLETE:** TI has discontinued the production of the device.

(2) **RoHS:** TI defines "RoHS" to mean semiconductor products that are compliant with the current EU RoHS requirements for all 10 RoHS substances, including the requirement that RoHS substance do not exceed 0.1% by weight in homogeneous materials. Where designed to be soldered at high temperatures, "RoHS" products are suitable for use in specified lead-free processes. TI may reference these types of products as "Pb-Free".

**RoHS Exempt:** TI defines "RoHS Exempt" to mean products that contain lead but are compliant with EU RoHS pursuant to a specific EU RoHS exemption.

**Green:** TI defines "Green" to mean the content of Chlorine (Cl) and Bromine (Br) based flame retardants meet JS709B low halogen requirements of <=1000ppm threshold. Antimony trioxide based flame retardants must also meet the <=1000ppm threshold requirement.

(3) MSL, Peak Temp. - The Moisture Sensitivity Level rating according to the JEDEC industry standard classifications, and peak solder temperature.

(4) There may be additional marking, which relates to the logo, the lot trace code information, or the environmental category on the device.

(5) Multiple Device Markings will be inside parentheses. Only one Device Marking contained in parentheses and separated by a "~" will appear on a device. If a line is indented then it is a continuation of the previous line and the two combined represent the entire Device Marking for that device.

(6) Lead finish/Ball material - Orderable Devices may have multiple material finish options. Finish options are separated by a vertical ruled line. Lead finish/Ball material values may wrap to two lines if the finish value exceeds the maximum column width.

**Important Information and Disclaimer:**The information provided on this page represents TI's knowledge and belief as of the date that it is provided. TI bases its knowledge and belief on information provided by third parties, and makes no representation or warranty as to the accuracy of such information. Efforts are underway to better integrate information from third parties. TI has taken and continues to take reasonable steps to provide representative and accurate information but may not have conducted destructive testing or chemical analysis on incoming materials and chemicals. TI and TI suppliers consider certain information to be proprietary, and thus CAS numbers and other limited information may not be available for release.

In no event shall TI's liability arising out of such information exceed the total purchase price of the TI part(s) at issue in this document sold by TI to Customer on an annual basis.

**OTHER QUALIFIED VERSIONS OF SN74AHC541-Q1 :**

- Catalog : [SN74AHC541](#)
- Military : [SN54AHC541](#)

## NOTE: Qualified Version Definitions:

- Catalog - TI's standard catalog product
- Military - QML certified for Military and Defense Applications

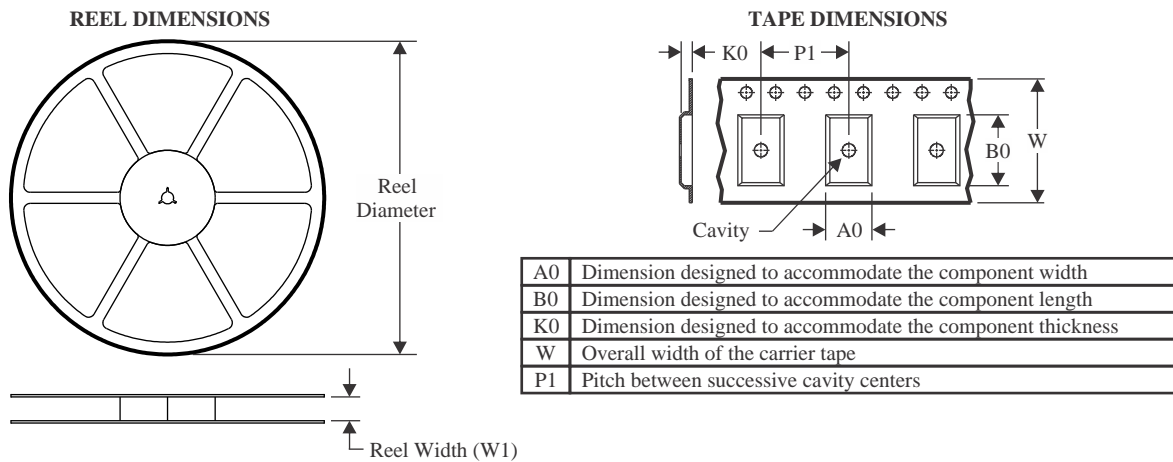
**TAPE AND REEL INFORMATION**

**QUADRANT ASSIGNMENTS FOR PIN 1 ORIENTATION IN TAPE**



\*All dimensions are nominal

Device	Package Type	Package Drawing	Pins	SPQ	Reel Diameter (mm)	Reel Width W1 (mm)	A0 (mm)	B0 (mm)	K0 (mm)	P1 (mm)	W (mm)	Pin1 Quadrant
SN74AHC541QPWRG4Q1	TSSOP	PW	20	2000	330.0	16.4	6.95	7.1	1.6	8.0	16.0	Q1
SN74AHC541QPWRQ1	TSSOP	PW	20	2000	330.0	16.4	6.95	7.1	1.6	8.0	16.0	Q1

**TAPE AND REEL BOX DIMENSIONS**

\*All dimensions are nominal

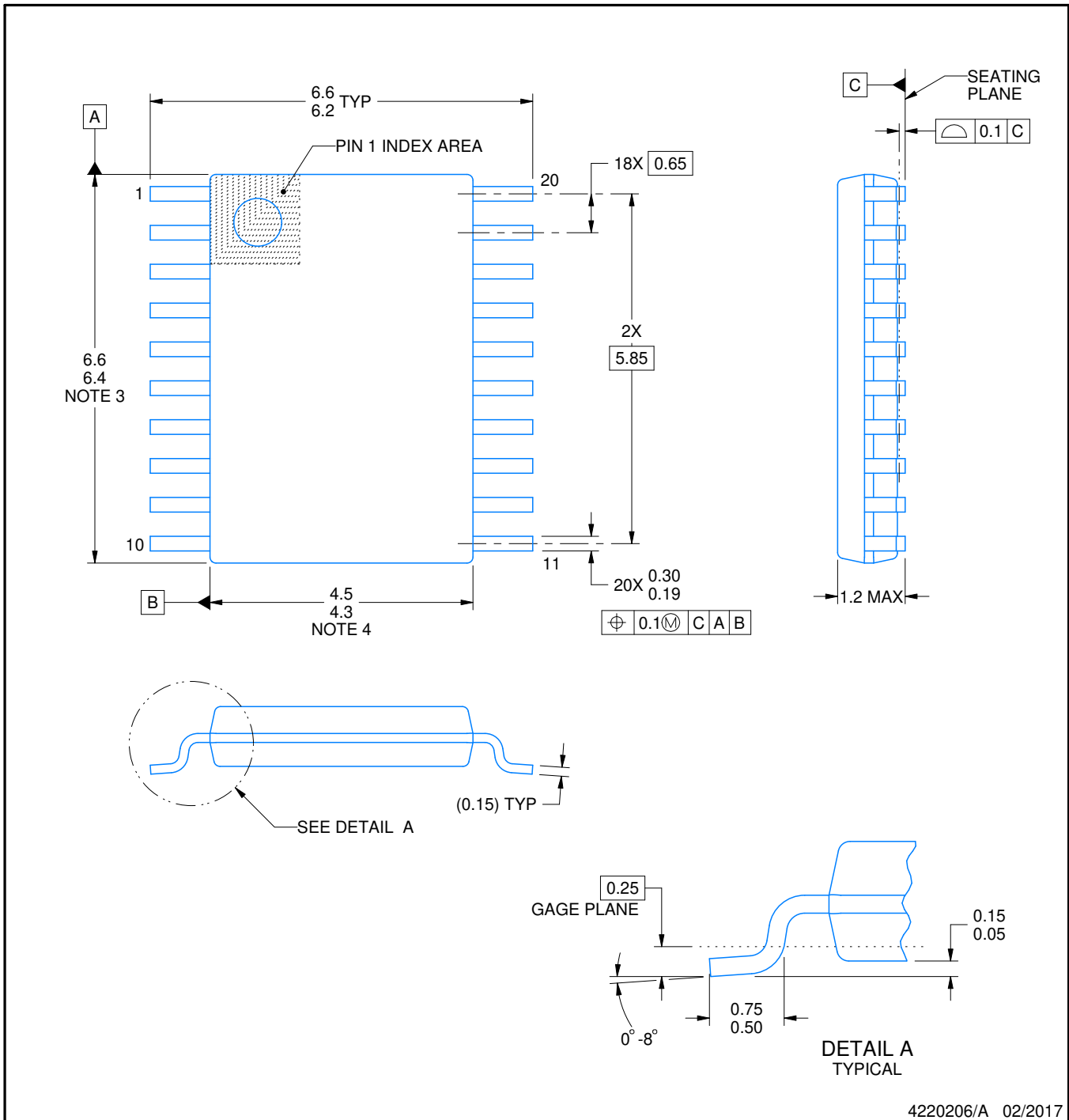
Device	Package Type	Package Drawing	Pins	SPQ	Length (mm)	Width (mm)	Height (mm)
SN74AHC541QPWRG4Q1	TSSOP	PW	20	2000	356.0	356.0	35.0
SN74AHC541QPWRQ1	TSSOP	PW	20	2000	356.0	356.0	35.0



4220206/A 02/2017

NOTES:

1. All linear dimensions are in millimeters. Any dimensions in parenthesis are for reference only. Dimensioning and tolerancing per ASME Y14.5M.
2. This drawing is subject to change without notice.
3. This dimension does not include mold flash, protrusions, or gate burrs. Mold flash, protrusions, or gate burrs shall not exceed 0.15 mm per side.
4. This dimension does not include interlead flash. Interlead flash shall not exceed 0.25 mm per side.
5. Reference JEDEC registration MO-153.



# EXAMPLE BOARD LAYOUT

PW0020A

TSSOP - 1.2 mm max height

SMALL OUTLINE PACKAGE

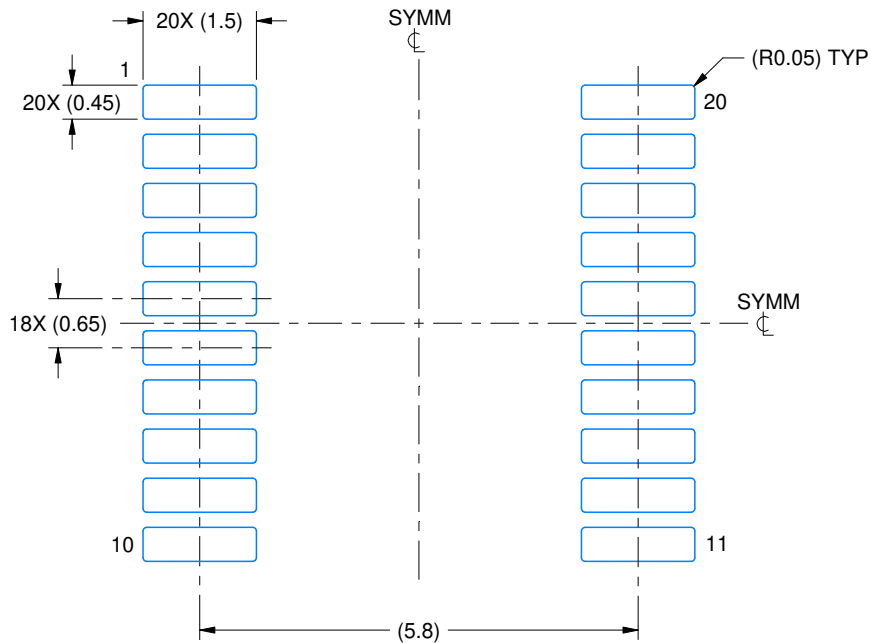

LAND PATTERN EXAMPLE  
EXPOSED METAL SHOWN  
SCALE: 10X



SOLDER MASK DETAILS

4220206/A 02/2017

NOTES: (continued)

- 6. Publication IPC-7351 may have alternate designs.
- 7. Solder mask tolerances between and around signal pads can vary based on board fabrication site.

# EXAMPLE STENCIL DESIGN

PW0020A

TSSOP - 1.2 mm max height

SMALL OUTLINE PACKAGE

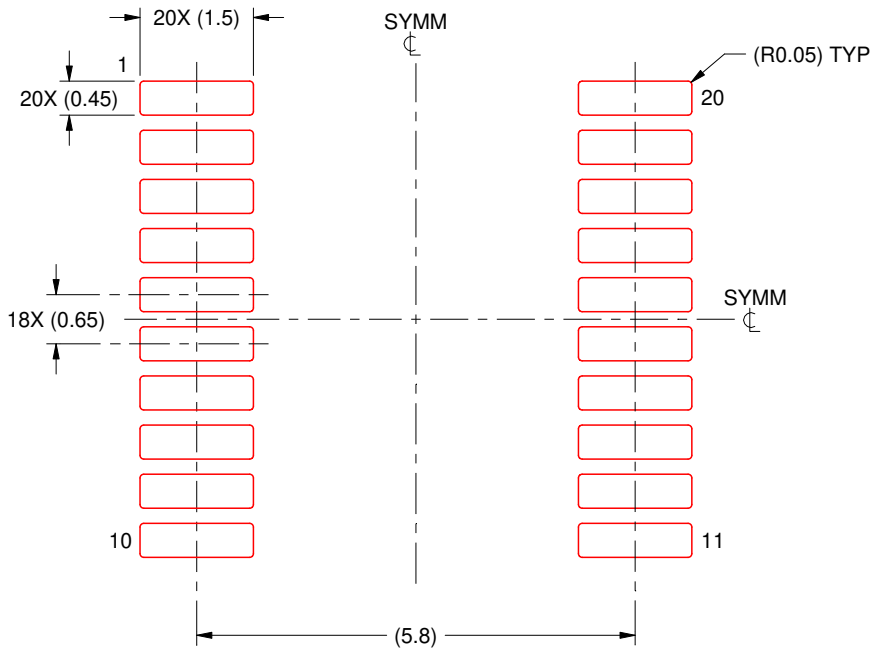

SOLDER PASTE EXAMPLE  
BASED ON 0.125 mm THICK STENCIL  
SCALE: 10X

4220206/A 02/2017

NOTES: (continued)

8. Laser cutting apertures with trapezoidal walls and rounded corners may offer better paste release. IPC-7525 may have alternate design recommendations.
9. Board assembly site may have different recommendations for stencil design.

PW (R-PDSO-G20)

PLASTIC SMALL OUTLINE

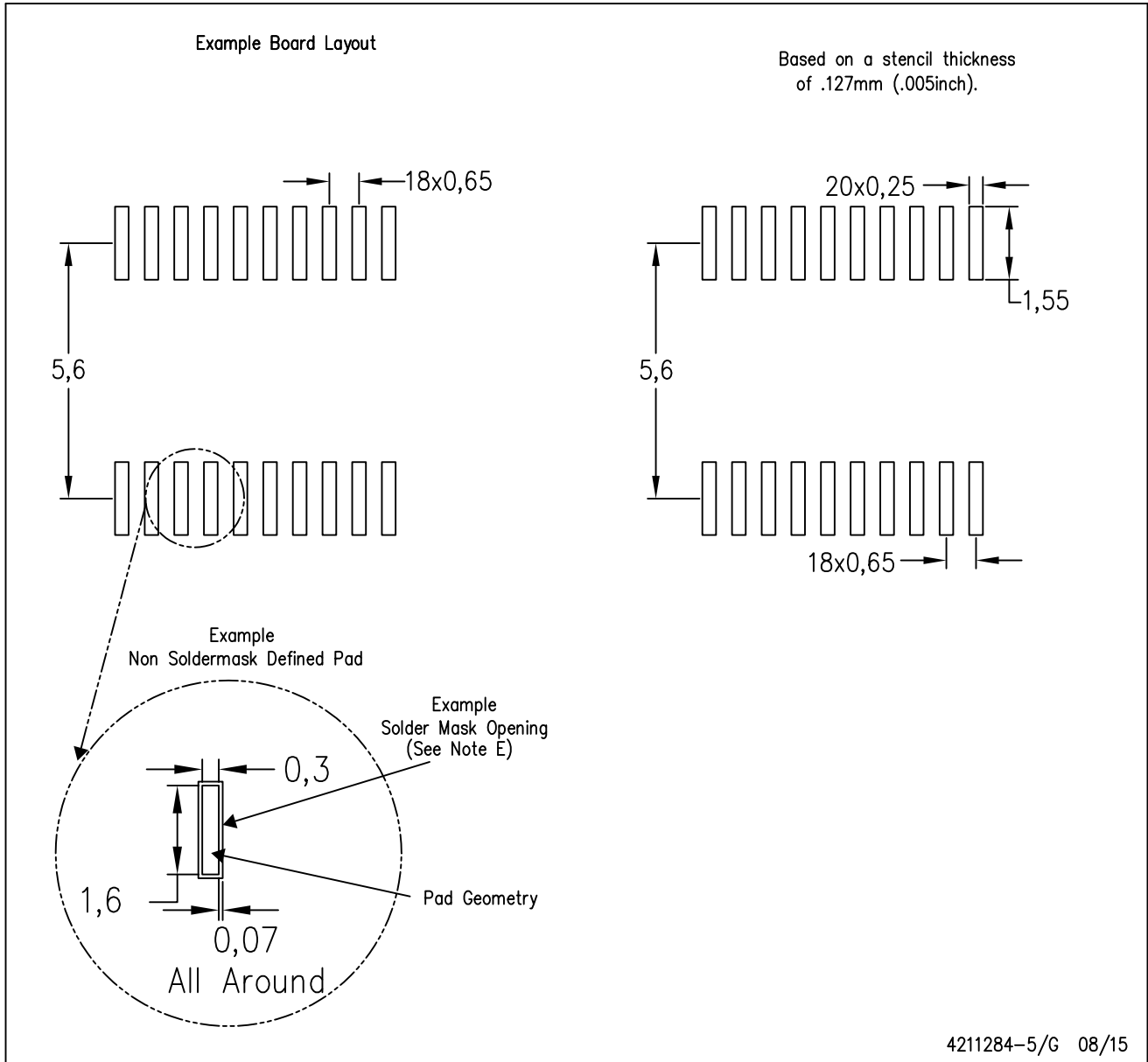

- NOTES:
- A. All linear dimensions are in millimeters.
  - B. This drawing is subject to change without notice.
  - C. Publication IPC-7351 is recommended for alternate design.
  - D. Laser cutting apertures with trapezoidal walls and also rounding corners will offer better paste release. Customers should contact their board assembly site for stencil design recommendations. Refer to IPC-7525 for other stencil recommendations.
  - E. Customers should contact their board fabrication site for solder mask tolerances between and around signal pads.

## IMPORTANT NOTICE AND DISCLAIMER

TI PROVIDES TECHNICAL AND RELIABILITY DATA (INCLUDING DATA SHEETS), DESIGN RESOURCES (INCLUDING REFERENCE DESIGNS), APPLICATION OR OTHER DESIGN ADVICE, WEB TOOLS, SAFETY INFORMATION, AND OTHER RESOURCES "AS IS" AND WITH ALL FAULTS, AND DISCLAIMS ALL WARRANTIES, EXPRESS AND IMPLIED, INCLUDING WITHOUT LIMITATION ANY IMPLIED WARRANTIES OF MERCHANTABILITY, FITNESS FOR A PARTICULAR PURPOSE OR NON-INFRINGEMENT OF THIRD PARTY INTELLECTUAL PROPERTY RIGHTS.

These resources are intended for skilled developers designing with TI products. You are solely responsible for (1) selecting the appropriate TI products for your application, (2) designing, validating and testing your application, and (3) ensuring your application meets applicable standards, and any other safety, security, regulatory or other requirements.

These resources are subject to change without notice. TI grants you permission to use these resources only for development of an application that uses the TI products described in the resource. Other reproduction and display of these resources is prohibited. No license is granted to any other TI intellectual property right or to any third party intellectual property right. TI disclaims responsibility for, and you will fully indemnify TI and its representatives against, any claims, damages, costs, losses, and liabilities arising out of your use of these resources.

TI's products are provided subject to [TI's Terms of Sale](#) or other applicable terms available either on [ti.com](https://www.ti.com) or provided in conjunction with such TI products. TI's provision of these resources does not expand or otherwise alter TI's applicable warranties or warranty disclaimers for TI products.

TI objects to and rejects any additional or different terms you may have proposed.

Mailing Address: Texas Instruments, Post Office Box 655303, Dallas, Texas 75265  
Copyright © 2023, Texas Instruments Incorporated