

KW3 CGLNM2.TK

OSLON® Compact PL

Compact light source with isolated thermal pad for improved heat dissipation and small z-tolerance ($\pm 35 \mu\text{m}$).

The OSLON Compact PL product family meets both excellent brightness in combination with outstanding luminance.



Applications

- Headlamps, LED & Laser & Night Vision

Features:

- Package: Ceramic package
- Chip technology: UX:3
- Typ. Radiation: 120° (Lambertian emitter)
- Color: $C_x = 0.325$, $C_y = 0.345$ acc. to CIE 1931 (● white)
- Corrosion Robustness Class: 3A
- Qualifications: AEC-Q102 Qualified
- ESD: 8 kV acc. to ANSI/ESDA/JEDEC JS-001 (HBM, Class 3B)
- Color over angle: Better than passus 3.7.2.1 of supplement proposal 7 to ECE reg. 128

Ordering Information

Type	Luminous Flux ¹⁾ $I_F = 1000 \text{ mA}$ Φ_v	Ordering Code
KW3 CGLNM2.TK-T2T9-4L07M0-JCAB	1060 ... 1425 lm	Q65112A9532

Maximum Ratings

Parameter	Symbol		Values
Operating Temperature ²⁾	T_{op}	min.	-40 °C
		max.	135 °C
Storage Temperature	T_{stg}	min.	-40 °C
		max.	135 °C
Junction Temperature	T_j	max.	150 °C
Junction Temperature for short time applications*	T_j	max.	175 °C
Forward current $T_s = 25\text{ °C}$	I_F	min.	50 mA
		max.	1500 mA
Surge current $t \leq 10\ \mu\text{s}$; $D = 0.005$; $T_s = 25\text{ °C}$	I_{FS}	max.	3000 mA
ESD withstand voltage acc. to ANSI/ESDA/JEDEC JS-001 (HBM, Class 3B)	V_{ESD}		8 kV
Reverse current ³⁾	I_R	max.	200 mA

* The median lifetime (L70/B50) for $T_j = 175\text{ °C}$ is 100h.

Characteristics

$I_F = 1000 \text{ mA}$; $T_S = 25 \text{ °C}$

Parameter	Symbol		Values
Chromaticity Coordinate ⁴⁾	C_x	typ.	0.325
	C_y	typ.	0.345
Viewing angle at 50% I_V	2ϕ	typ.	120 °
Forward Voltage ⁵⁾ $I_F = 1000 \text{ mA}$	V_F	min.	8.40 V
		typ.	9.45 V
		max.	10.15 V
Reverse voltage (ESD device)	$V_{R\text{ESD}}$	min.	45 V
Reverse voltage ³⁾ $I_R = 20 \text{ mA}$	V_R	max.	1.2 V
Real thermal resistance junction/solderpoint ⁶⁾	$R_{\text{thJS real}}$	typ.	2.6 K / W
		max.	3.3 K / W
Electrical thermal resistance junction/solderpoint ⁶⁾ with efficiency $\eta_e = 36 \%$	$R_{\text{thJS elec.}}$	typ.	1.7 K / W
		max.	2.1 K / W

Brightness Groups

Group	Luminous Flux ¹⁾ $I_F = 1000 \text{ mA}$ min. Φ_V	Luminous Flux ¹⁾ $I_F = 1000 \text{ mA}$ max. Φ_V
T2	1060 lm	1100 lm
T3	1100 lm	1140 lm
T4	1140 lm	1185 lm
T5	1185 lm	1230 lm
T6	1230 lm	1275 lm
T7	1275 lm	1325 lm
T8	1325 lm	1375 lm
T9	1375 lm	1425 lm

Forward Voltage Groups

Group	Forward Voltage ⁵⁾ $I_F = 1000 \text{ mA}$ min. V_F	Forward Voltage ⁵⁾ $I_F = 1000 \text{ mA}$ max. V_F
JC	8.40 V	9.00 V
WC	9.00 V	9.60 V
AB	9.60 V	10.15 V

Chromaticity Coordinate Groups

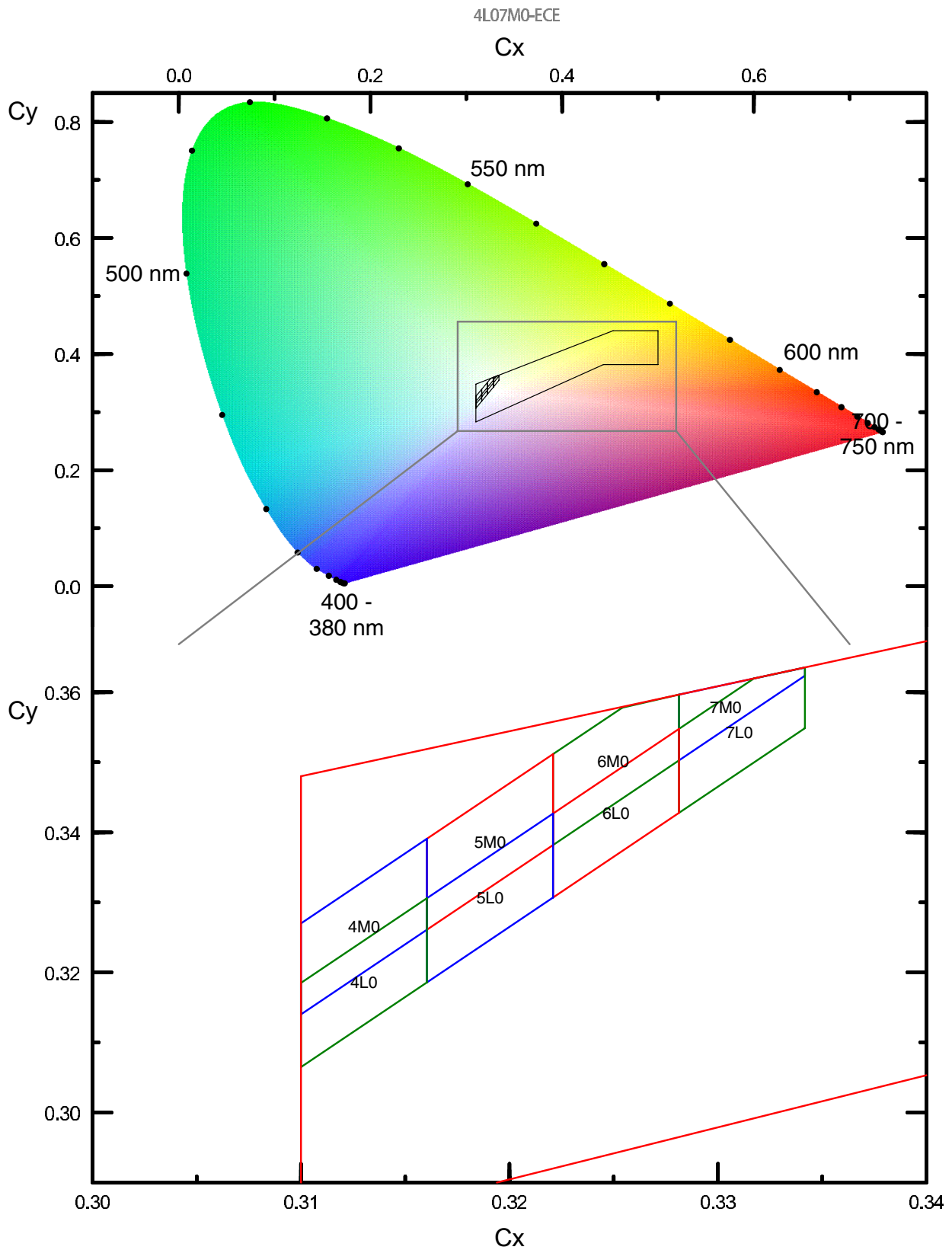

Chromaticity Coordinate Groups ⁴⁾

Group	Cx	Cy	Group	Cx	Cy	Group	Cx	Cy
4L0	0.3100	0.3065	5M0	0.3160	0.3261	7L0	0.3281	0.3428
	0.3100	0.3185		0.3160	0.3391		0.3281	0.3548
	0.3160	0.3306		0.3221	0.3512		0.3317	0.3620
	0.3160	0.3186		0.3221	0.3382		0.3342	0.3635
4M0	0.3100	0.3140	6L0	0.3221	0.3307	7M0	0.3281	0.3503
	0.3100	0.3270		0.3221	0.3427		0.3281	0.3597
	0.3160	0.3391		0.3281	0.3548		0.3342	0.3635
	0.3160	0.3261		0.3281	0.3428		0.3342	0.3624
5L0	0.3160	0.3186	6M0	0.3221	0.3382			
	0.3160	0.3306		0.3221	0.3512			
	0.3221	0.3427		0.3254	0.3578			
	0.3221	0.3307		0.3281	0.3597			
			0.3281	0.3503				

Group Name on Label

Example: T2-4L0-AB

Brightness

Color Chromaticity

Forward Voltage

T2

4L0

AB

Relative Spectral Emission ⁷⁾

$\Phi_{rel} = f(\lambda); I_F = 1000 \text{ mA}; T_J = 25 \text{ }^\circ\text{C}$

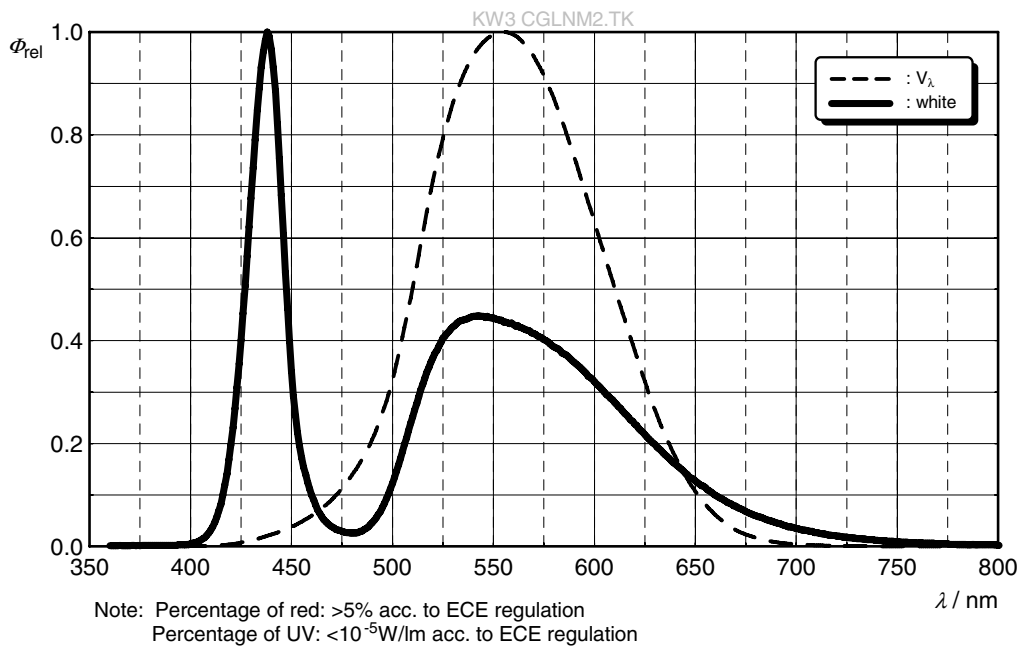

Radiation Characteristics ⁷⁾

$I_{rel} = f(\phi); T_J = 25 \text{ }^\circ\text{C}$

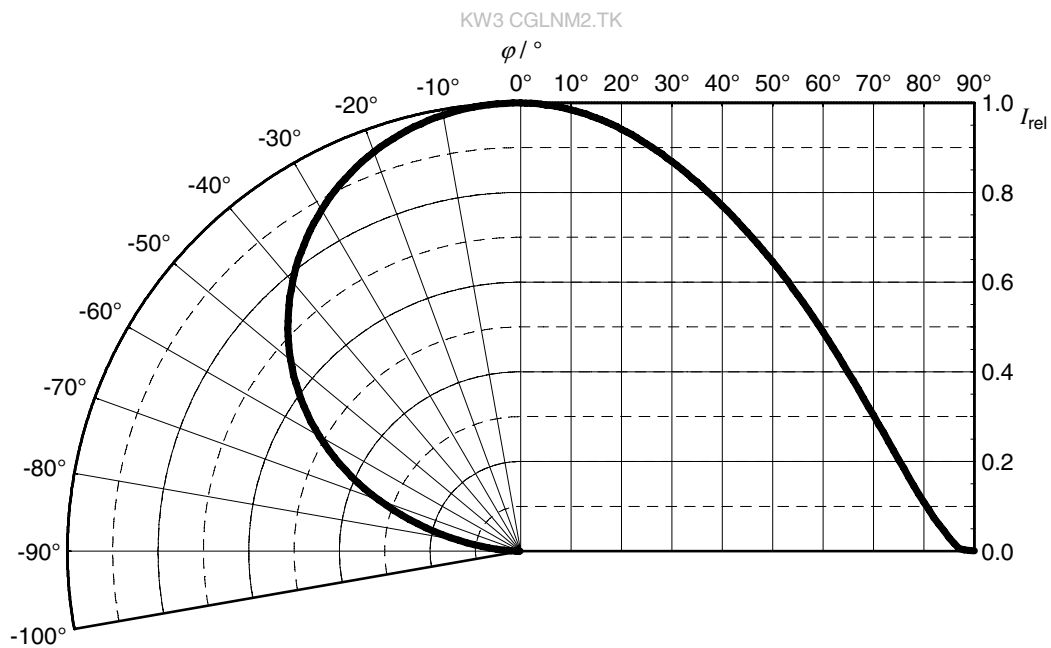

Forward current ⁷⁾

$I_F = f(V_F); T_J = 25\text{ }^\circ\text{C}$

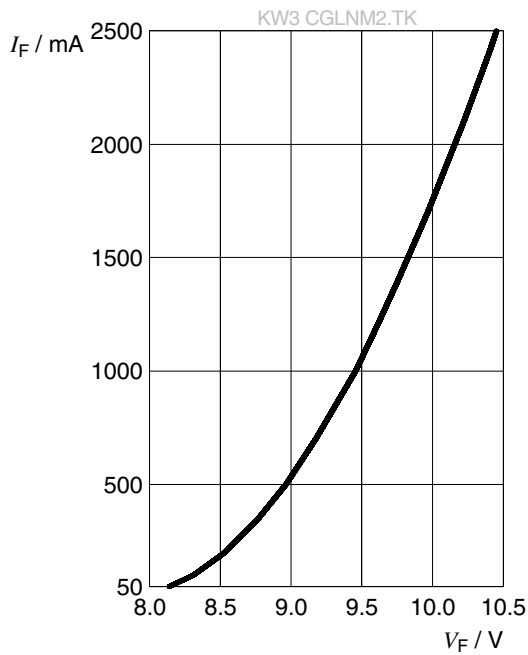

Relative Luminous Flux ^{7), 8)}

$\Phi_V / \Phi_V(1000\text{ mA}) = f(I_F); T_J = 25\text{ }^\circ\text{C}$

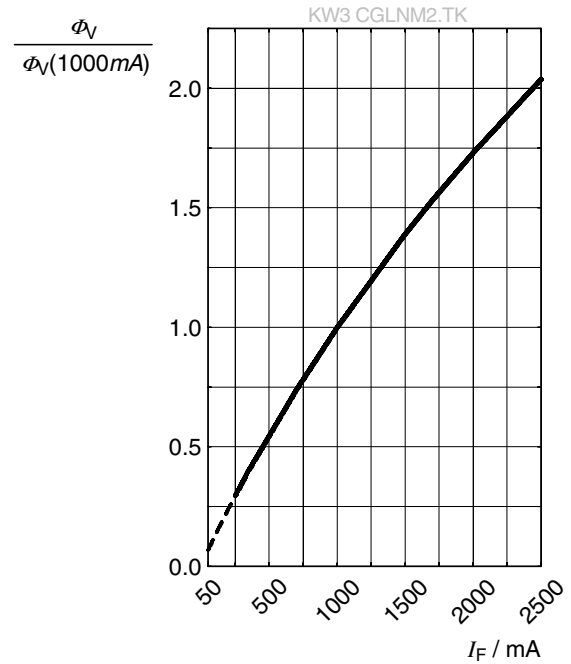

Chromaticity Coordinate Shift ⁷⁾

$C_x, C_y = f(I_F); T_J = 25\text{ }^\circ\text{C}$

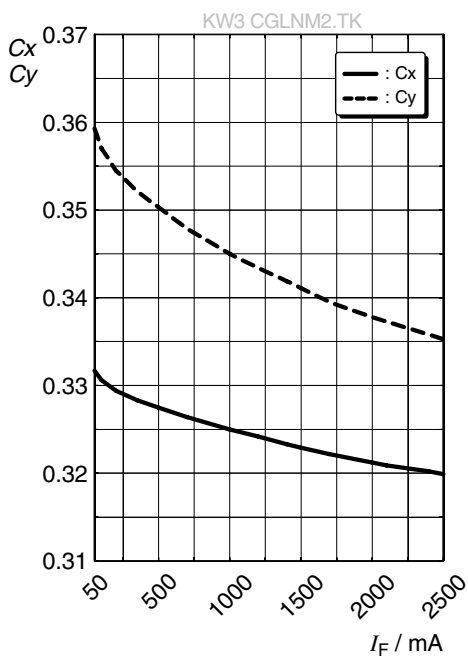

Forward Voltage ⁷⁾

$$\Delta V_F = V_F - V_F(25\text{ °C}) = f(T_j); I_F = 1000\text{ mA}$$

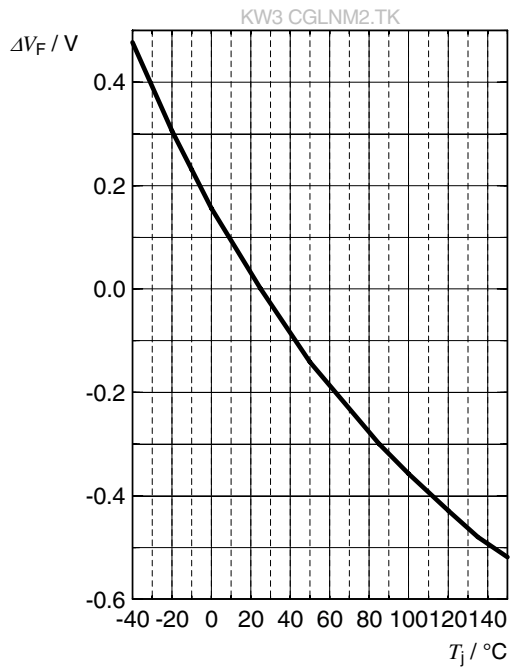

Relative Luminous Flux ⁷⁾

$$\Phi_V / \Phi_V(25\text{ °C}) = f(T_j); I_F = 1000\text{ mA}$$

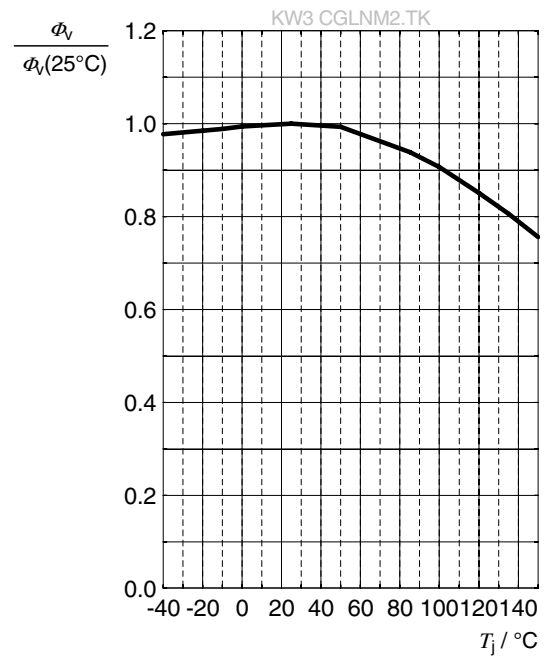

Chromaticity Coordinate Shift ⁷⁾

$$C_x, C_y = f(T_j); I_F = 1000\text{ mA}$$

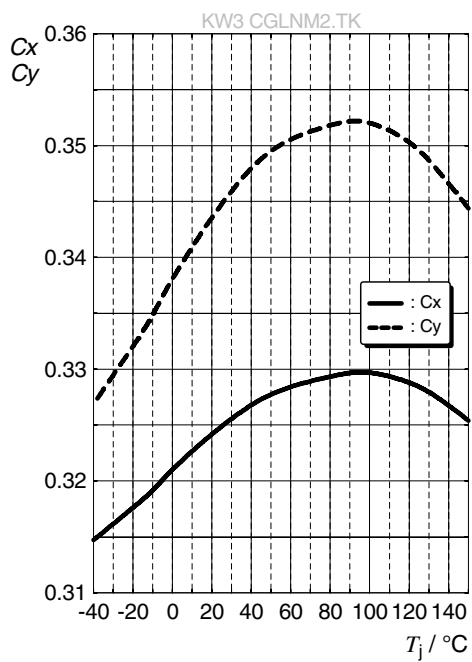

Max. Permissible Forward Current

$I_F = f(T)$

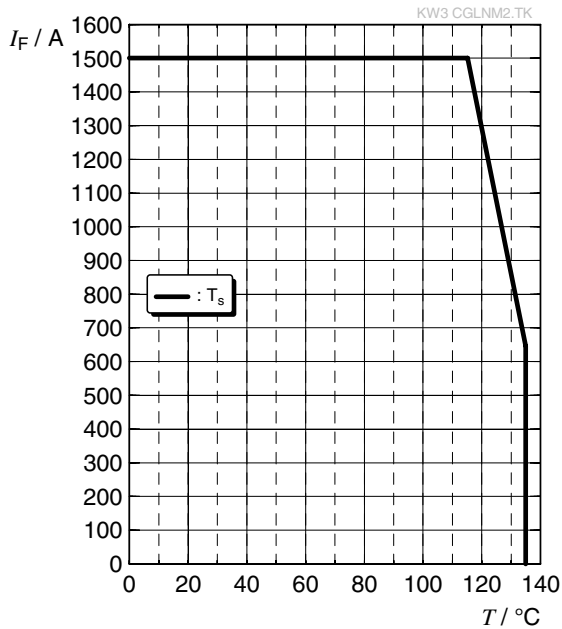

Permissible Pulse Handling Capability

$I_F = f(t_p)$; D: Duty cycle

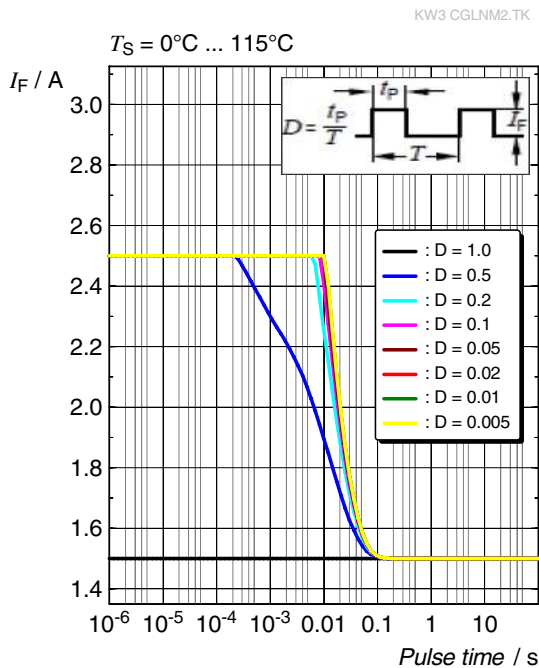

Permissible Pulse Handling Capability

$I_F = f(t_p)$; D: Duty cycle

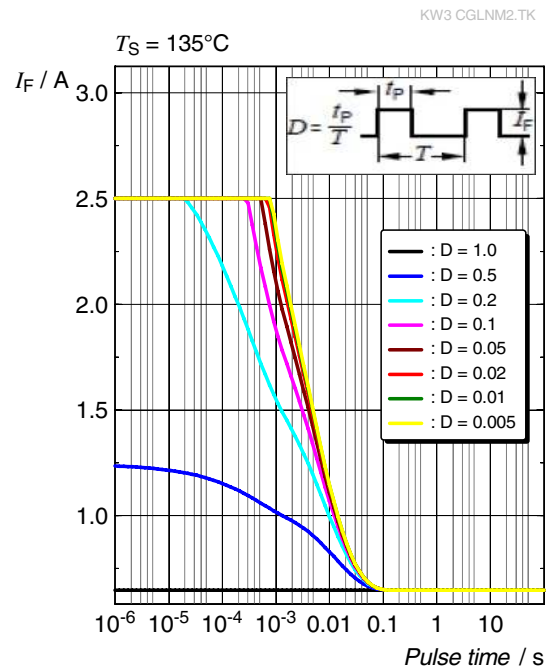

Permissible F. Handling Capability

f: Frequency

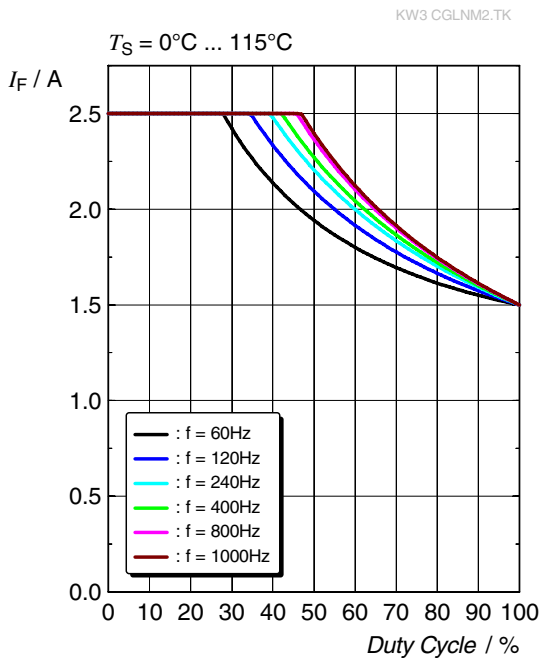

Permissible F. Handling Capability

f: Frequency

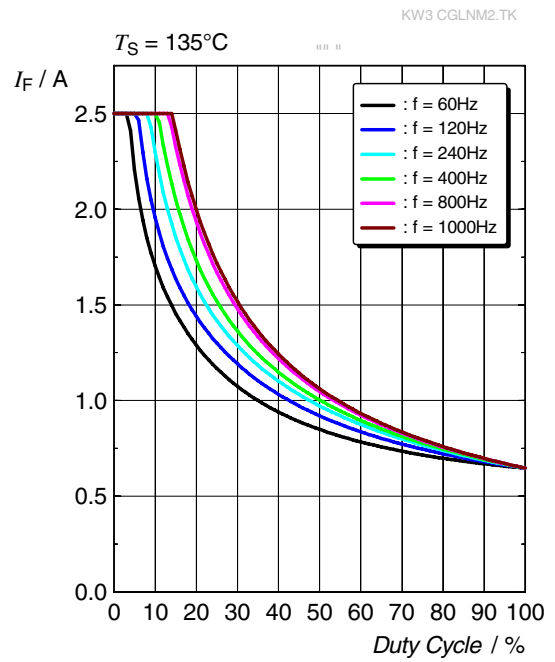

Dimensional Drawing ⁹⁾

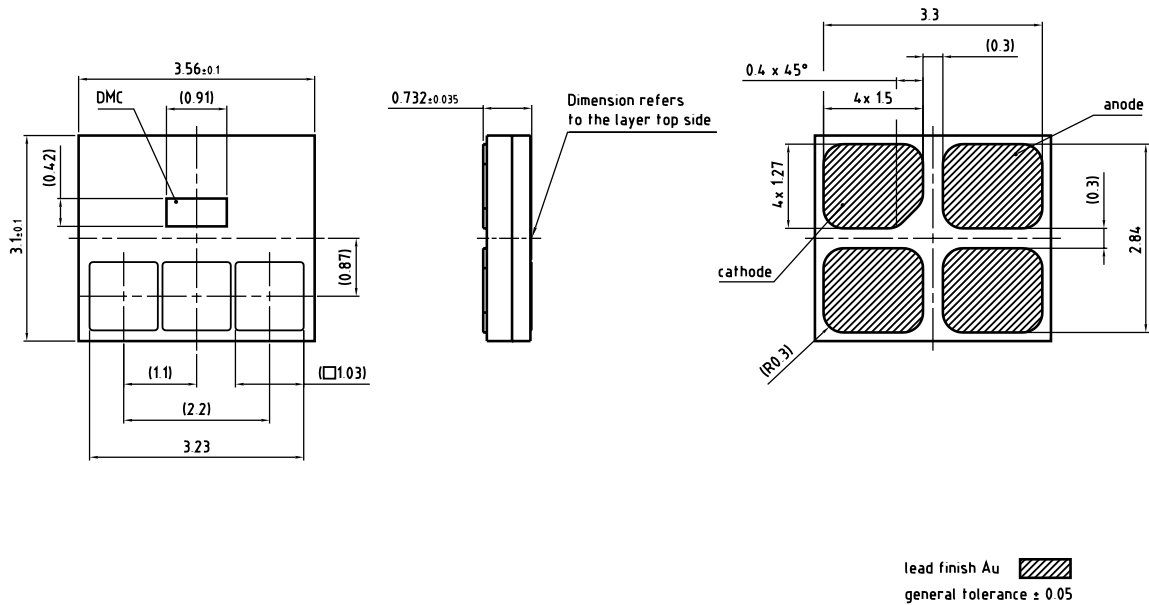

C63062-A4406-A1-02

Further Information:

Approximate Weight: 28.5 mg

Corrosion test: Class: 3A
 Test condition: $40^\circ\text{C} / 90\% \text{ RH} / 15 \text{ ppm H}_2\text{S} / 14 \text{ days}$ (stricter than IEC 60068-2-43)

ESD advice: The device is protected by ESD device which is connected in parallel to the Chip.

Electrical Internal Circuit

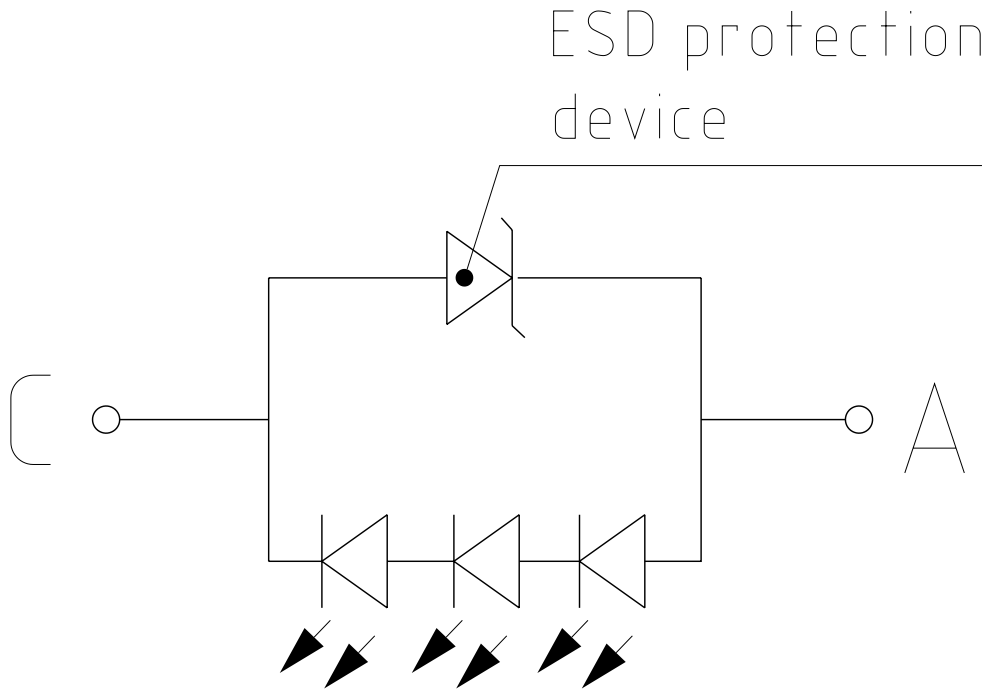

Recommended Solder Pad ⁹⁾

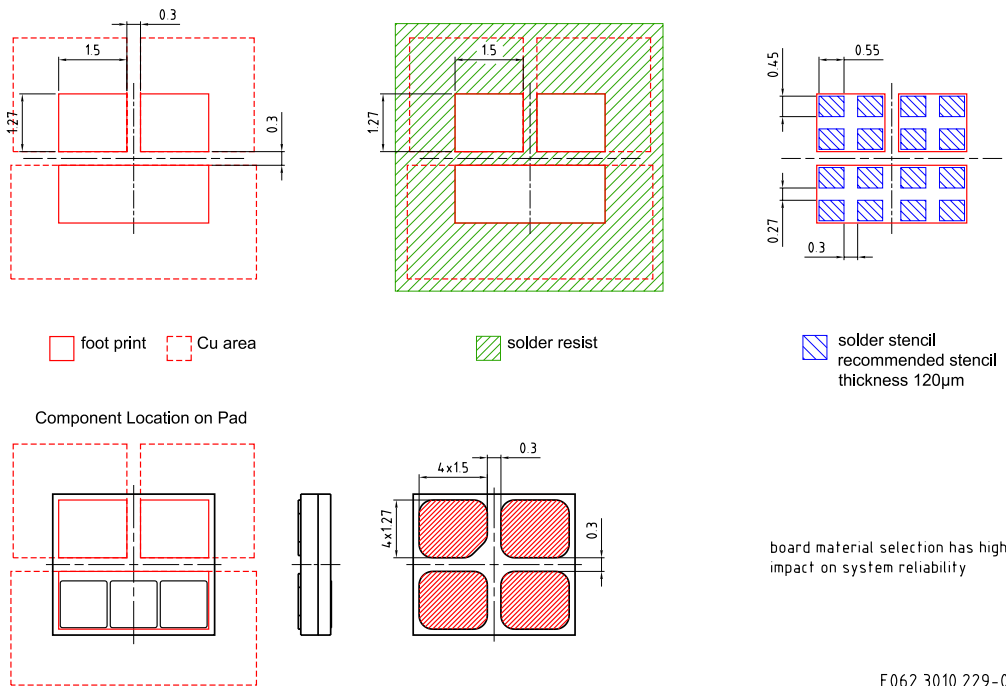

E062.3010.229-02

For superior solder joint connectivity results we recommend soldering under standard nitrogen atmosphere. Package not suitable for ultra sonic cleaning. To ensure a high solder joint reliability and to minimize the risk of solder joint cracks, the customer is responsible to evaluate the combination of PCB board and solder paste material for his application.

Reflow Soldering Profile

Product complies to MSL Level 2 acc. to JEDEC J-STD-020E

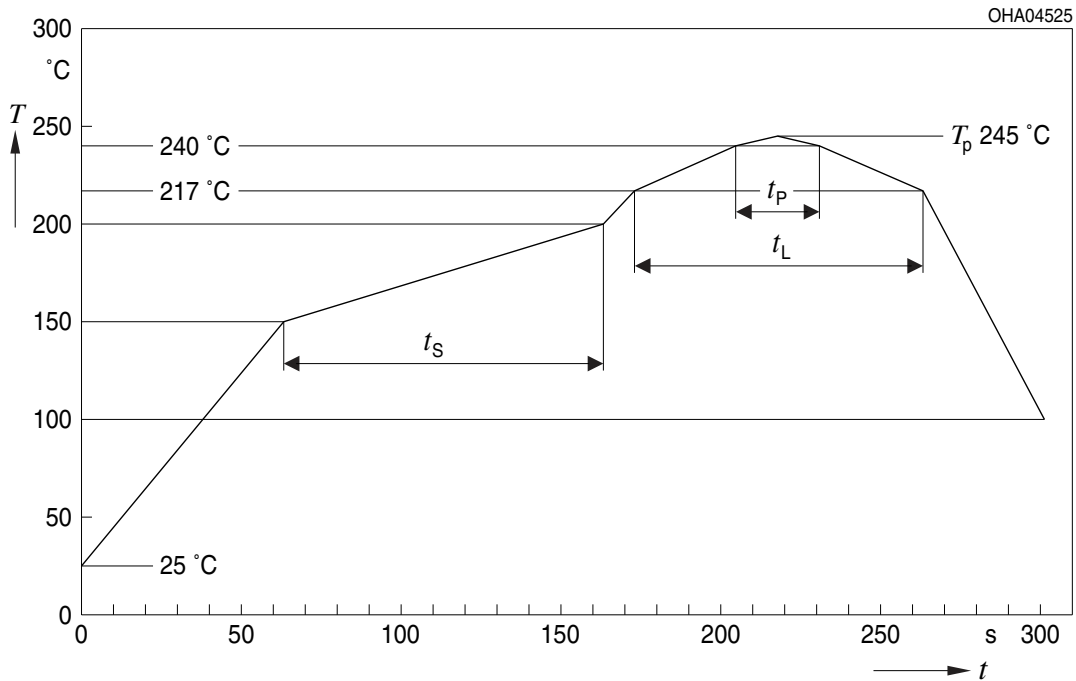

Profile Feature	Symbol	Pb-Free (SnAgCu) Assembly			Unit
		Minimum	Recommendation	Maximum	
Ramp-up rate to preheat ^{*)} 25 °C to 150 °C			2	3	K/s
Time t_s T_{Smin} to T_{Smax}	t_s	60	100	120	s
Ramp-up rate to peak ^{*)} T_{Smax} to T_p			2	3	K/s
Liquidus temperature	T_L		217		°C
Time above liquidus temperature	t_L		80	100	s
Peak temperature	T_p		245	260	°C
Time within 5 °C of the specified peak temperature $T_p - 5$ K	t_p	10	20	30	s
Ramp-down rate* T_p to 100 °C			3	6	K/s
Time 25 °C to T_p				480	s

All temperatures refer to the center of the package, measured on the top of the component

* slope calculation DT/Dt : Dt max. 5 s; fulfillment for the whole T-range

Taping ⁹⁾

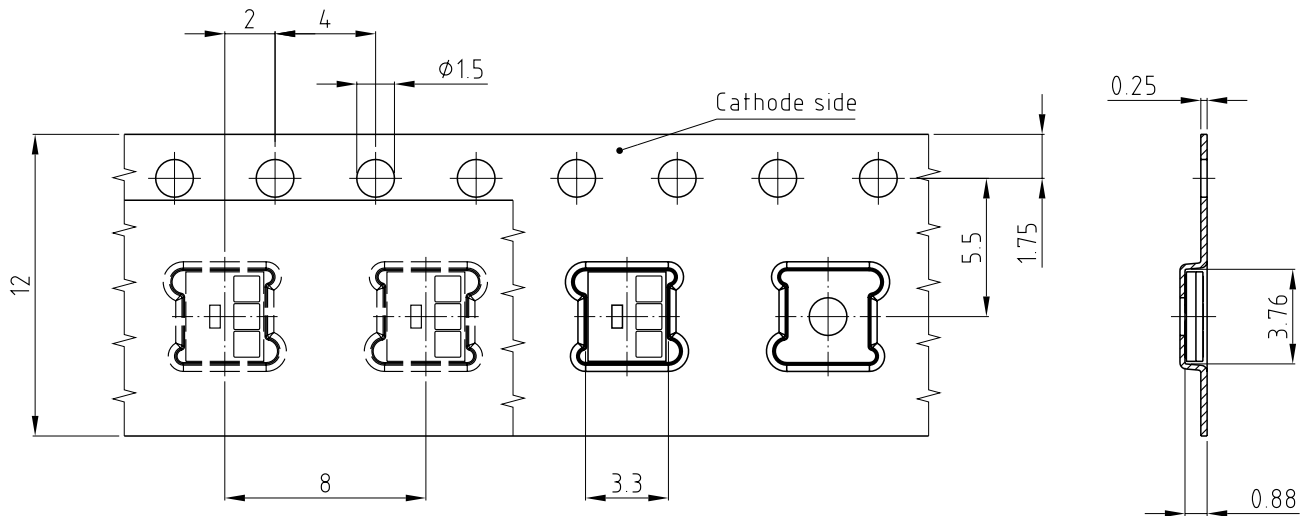

C63062-A4406-B9-02

Tape and Reel ¹⁰⁾

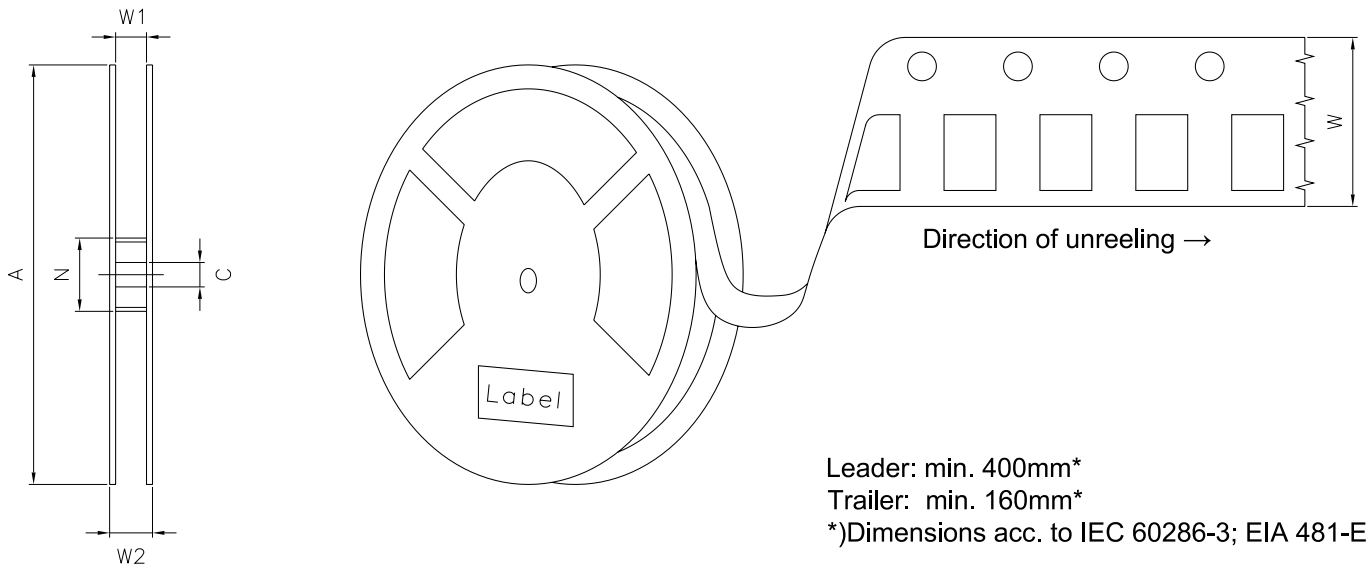

Reel Dimensions

A	W	N _{min}	W ₁	W _{2max}	Pieces per PU
180 mm	12 + 0.3 / - 0.1 mm	60 mm	12.4 + 2 mm	18.4 mm	2000

Barcode-Product-Label (BPL)

OSRAM Opto Semiconductors LX XXXX BIN1: XX-XX-X-XXX-X

RoHS Compliant

(6P) BATCH NO: 1234567890

(1T) LOT NO: 1234567890 (9D) D/C: 1234

(X) PROD NO: 123456789(Q)QTY: 9999 (G) GROUP: XX-XX-X-X

ML Temp ST
X XXX °C X

Pack: RXX
DEMY XXX
X_X123_1234.1234 X

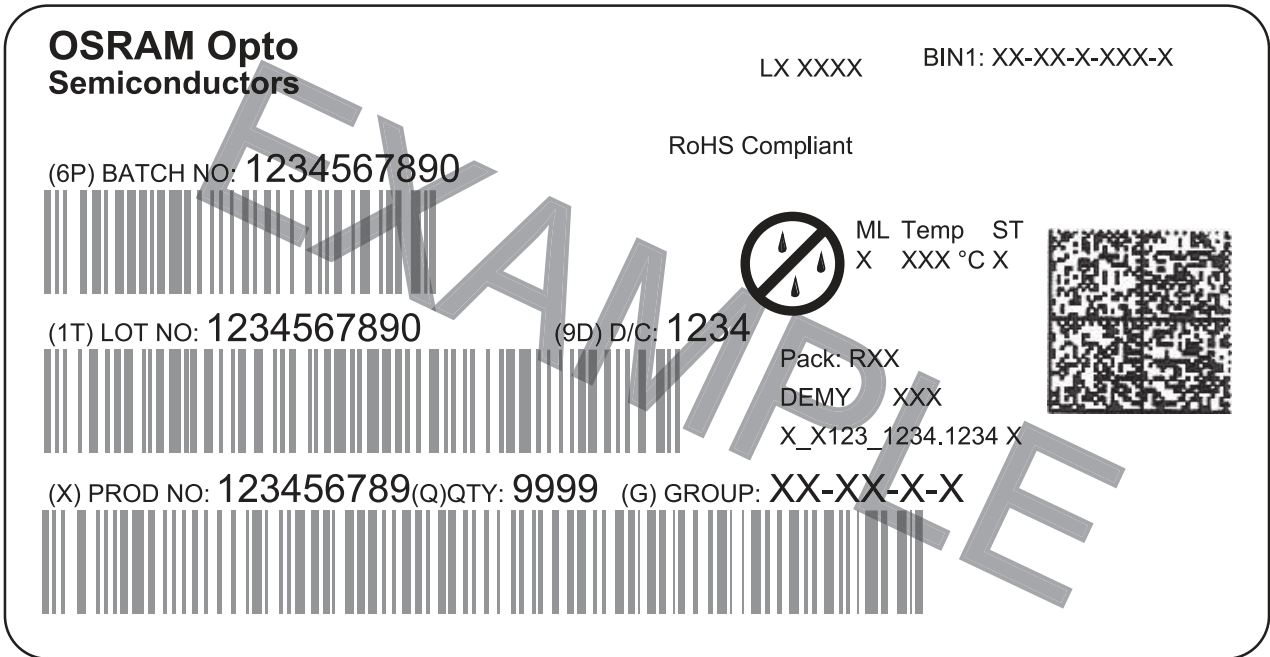

The diagram shows a rectangular label with rounded corners. It contains the OSRAM logo and product name at the top left. To the right are fields for 'LX XXXX' and 'BIN1: XX-XX-X-XXX-X'. Below this is 'RoHS Compliant'. The main body of the label features three rows of information, each with a barcode: '(6P) BATCH NO: 1234567890', '(1T) LOT NO: 1234567890 (9D) D/C: 1234', and '(X) PROD NO: 123456789(Q)QTY: 9999 (G) GROUP: XX-XX-X-X'. To the right of the second row is a 'No Moisture' symbol (a circle with a diagonal line and three drops) and 'ML Temp ST X XXX °C X'. Below that is 'Pack: RXX', 'DEMY XXX', and 'X_X123_1234.1234 X'. A square QR code is located on the right side of the label.

OHA04563

Dry Packing Process and Materials ⁹⁾

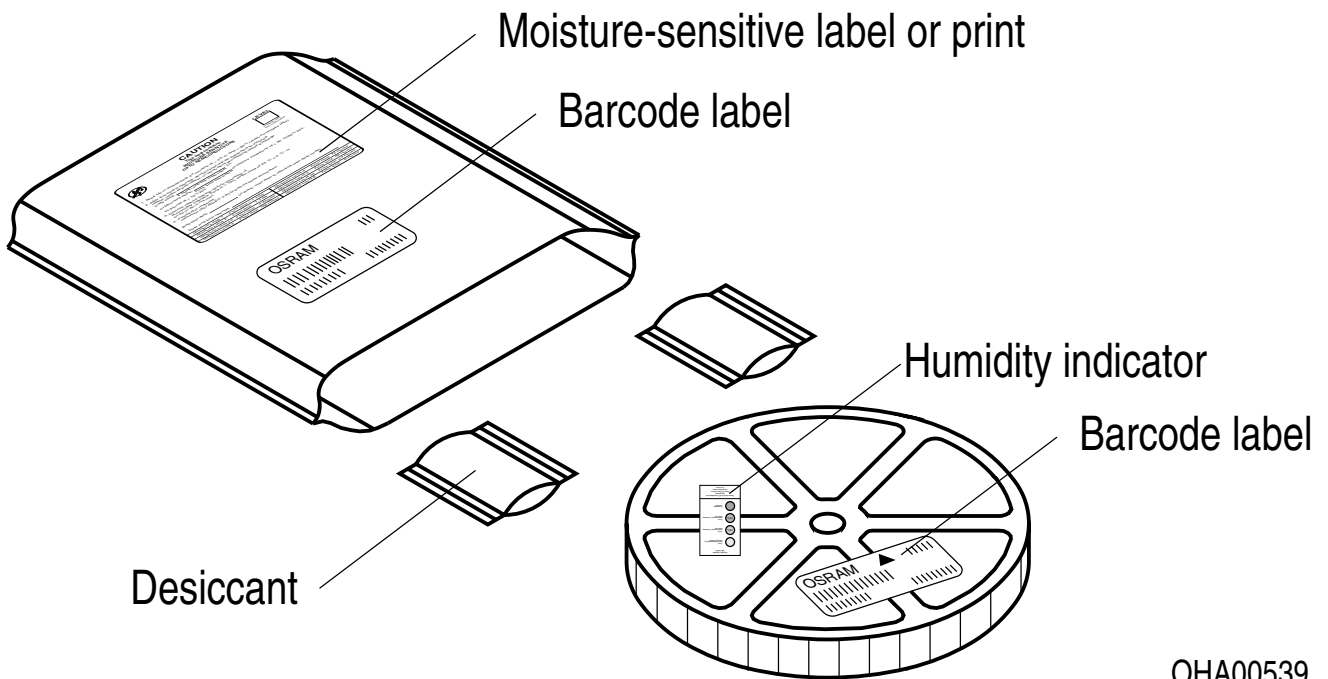

OHA00539

Moisture-sensitive product is packed in a dry bag containing desiccant and a humidity card according JEDEC-STD-033.

Type Designation System – OSLON Compact PL

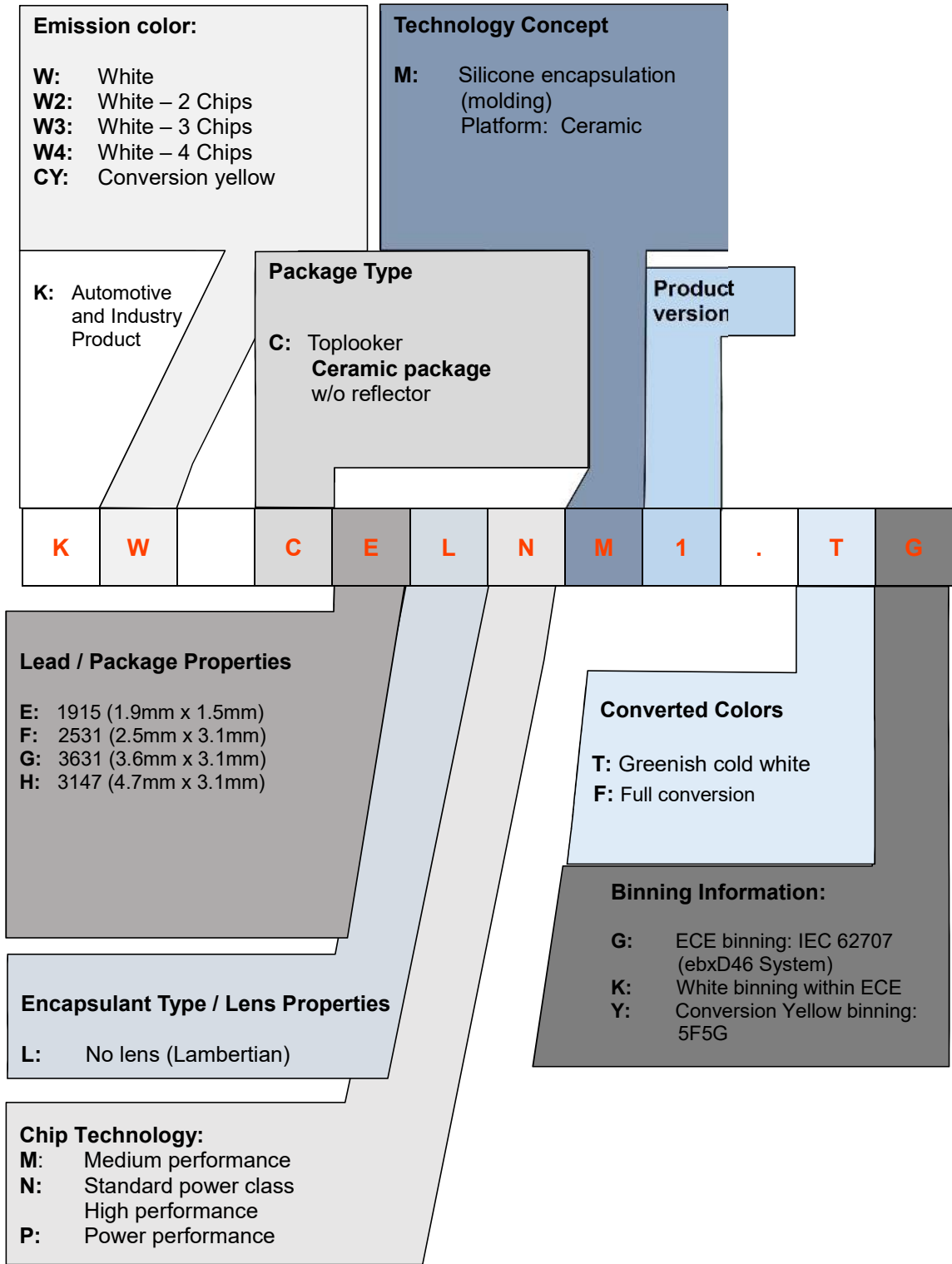

Notes

The evaluation of eye safety occurs according to the standard IEC 62471:2006 (photo biological safety of lamps and lamp systems). Within the risk grouping system of this IEC standard, the device specified in this data sheet fall into the class **moderate risk (exposure time 0.25 s)**. Under real circumstances (for exposure time, conditions of the eye pupils, observation distance), it is assumed that no endangerment to the eye exists from these devices. As a matter of principle, however, it should be mentioned that intense light sources have a high secondary exposure potential due to their blinding effect. When looking at bright light sources (e.g. headlights), temporary reduction in visual acuity and afterimages can occur, leading to irritation, annoyance, visual impairment, and even accidents, depending on the situation.

Subcomponents of this device contain, in addition to other substances, metal filled materials. Metal filled materials can be affected by environments that contain traces of aggressive substances. Therefore, we recommend that customers avoid device exposure to aggressive substances during storage, production, and use.

For further application related information please visit www.osram-os.com/appnotes

Disclaimer

Attention please!

The information describes the type of component and shall not be considered as assured characteristics. Terms of delivery and rights to change design reserved. Due to technical requirements components may contain dangerous substances.

For information on the types in question please contact our Sales Organization.

If printed or downloaded, please find the latest version on the OSRAM OS website.

Packing

Please use the recycling operators known to you. We can also help you – get in touch with your nearest sales office. By agreement we will take packing material back, if it is sorted. You must bear the costs of transport. For packing material that is returned to us unsorted or which we are not obliged to accept, we shall have to invoice you for any costs incurred.

Product and functional safety devices/applications or medical devices/applications

OSRAM OS components are not developed, constructed or tested for the application as safety relevant component or for the application in medical devices.

OSRAM OS products are not qualified at module and system level for such application.

In case buyer – or customer supplied by buyer – considers using OSRAM OS components in product safety devices/applications or medical devices/applications, buyer and/or customer has to inform the local sales partner of OSRAM OS immediately and OSRAM OS and buyer and /or customer will analyze and coordinate the customer-specific request between OSRAM OS and buyer and/or customer.

Glossary

- 1) **Brightness:** Brightness values are measured during a current pulse of typically 1 ms, with an internal reproducibility of $\pm 8\%$ and an expanded uncertainty of $\pm 11\%$ (acc. to GUM with a coverage factor of $k = 3$).
- 2) **Operating Temperature:** The Operating Temperature T_{op} is referenced to the Solderpoint T_s of this device. Proper current derating must be observed to maintain junction temperature below the maximum.
- 3) **Reverse Operation:** This product is intended to be operated applying a forward current within the specified range. Applying any continuous reverse bias or forward bias below the voltage range of light emission shall be avoided because it may cause migration which can change the electro-optical characteristics or damage the LED.
- 4) **Chromaticity coordinate groups:** Chromaticity coordinates are measured during a current pulse of typically 1 ms, with an internal reproducibility of ± 0.005 and an expanded uncertainty of ± 0.01 (acc. to GUM with a coverage factor of $k = 3$).
- 5) **Forward Voltage:** The forward voltage is measured during a current pulse of typically 1 ms, with an internal reproducibility of $\pm 0.05\text{ V}$ and an expanded uncertainty of $\pm 0.1\text{ V}$ (acc. to GUM with a coverage factor of $k = 3$).
- 6) **Thermal Resistance:** $R_{th\ max}$ is based on statistic values (6σ).
- 7) **Typical Values:** Due to the special conditions of the manufacturing processes of semiconductor devices, the typical data or calculated correlations of technical parameters can only reflect statistical figures. These do not necessarily correspond to the actual parameters of each single product, which could differ from the typical data and calculated correlations or the typical characteristic line. If requested, e.g. because of technical improvements, these typ. data will be changed without any further notice.
- 8) **Characteristic curve:** In the range where the line of the graph is broken, you must expect higher differences between single devices within one packing unit.
- 9) **Tolerance of Measure:** Unless otherwise noted in drawing, tolerances are specified with ± 0.1 and dimensions are specified in mm.
- 10) **Tape and Reel:** All dimensions and tolerances are specified acc. IEC 60286-3 and specified in mm.

Revision History

Version	Date	Change
1.0	2020-06-29	Initial Version
1.1	2021-09-01	Characteristics Electro - Optical Characteristics (Diagrams) Notes

Published by OSRAM Opto Semiconductors GmbH EU RoHS and China RoHS compliant product
Leibnizstraße 4, D-93055 Regensburg
www.osram-os.com © All Rights Reserved.



此产品符合欧盟 RoHS 指令的要求；
按照中国的相关法规和标准，不含有毒有害物质或元素。