

1

2

3

4

5

6

7

A

A

B

B

C

C

D

D

E

E

F

F

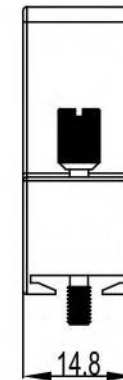
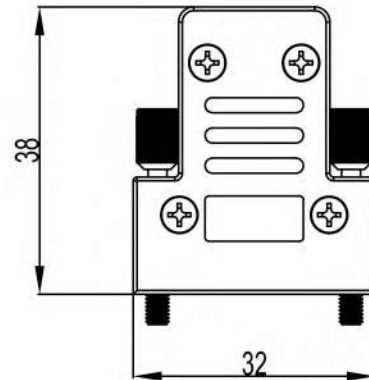
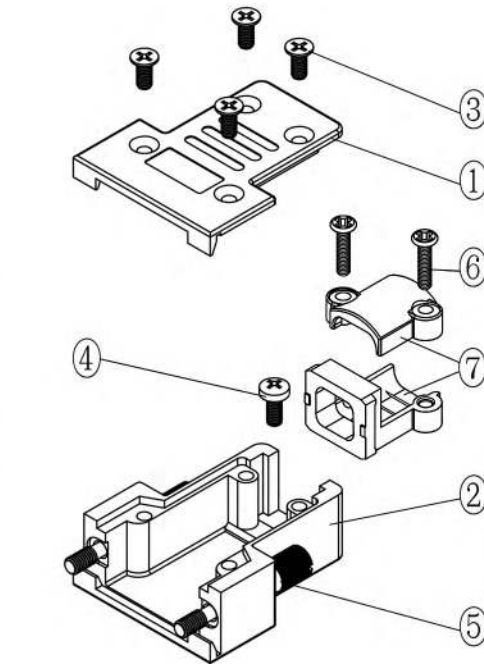

#### TECHNICAL SPECIFICATIONS

Material: Zinc  
 Plating: Nickel over Copper  
 Operating Temperature: -40°C to +120°C  
 Thumbscrews: UNC 4-40

No. of contacts: 09-15-25

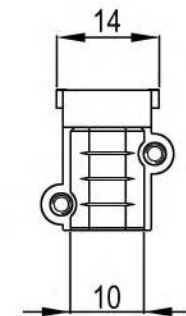
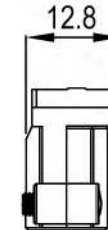
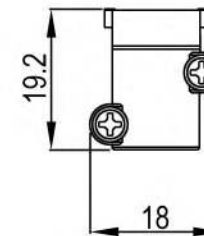
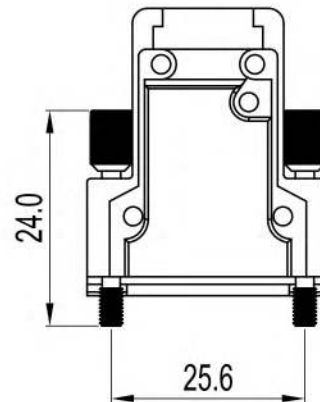

Item	QTY	Part description
1	1	Upper Cover
2	1	Lower Cover
3	4	M2.5x6 CSK Screw
4	1	M2.5x6 Pozi Screw
5	2	UNC 4-40x24 Jackscrew
6	2	M2.5x10 Screw
7	1	Cable Strain Relief

**RoHS compliant**  
 Unit: mm

Scale	Free				Date	Name	Customer-No.	
TOLERANCE					Drawn	17.08.2017	S.Bölling	
0~6	±0.10				Approved	17.08.2017	S.Bölling	
6~30	±0.20							
30~120	±0.30							
120~400	±0.50							
DIM	Tol							
Angle	±1°	Ⓢ	Drawn	17.08.2017				S.Bölling
Angle	Tol	Id.	Modification	Date				Name

Customer-No.  
 ASSMANN WSW-No.  
**ACOV-SUB-09MB7**

Drawing-No.  
**ASS\_5248\_CO** rev00  
 Replace  
 Sheet 1/3

1

2

3

4

5

6

7

SV4382

1 2 3 4 5 6 7

A A

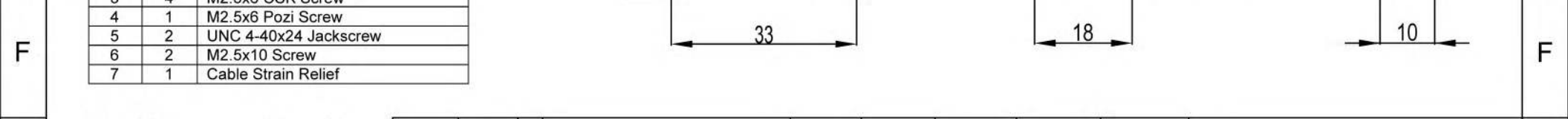
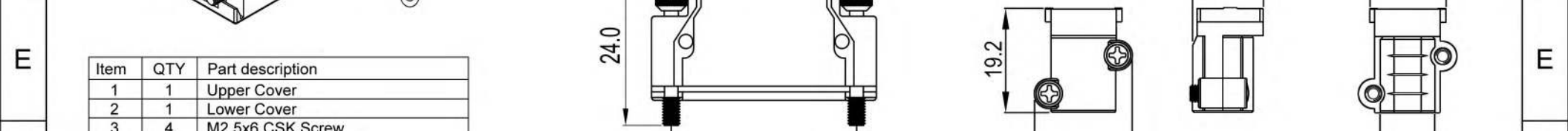
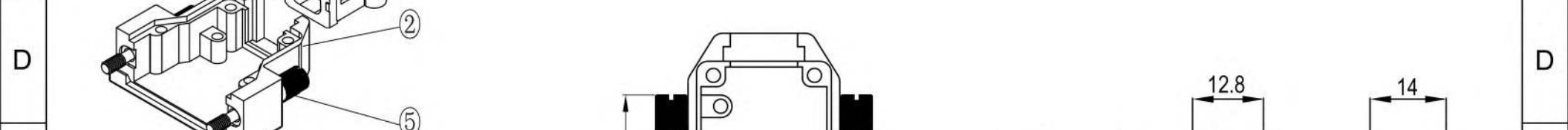
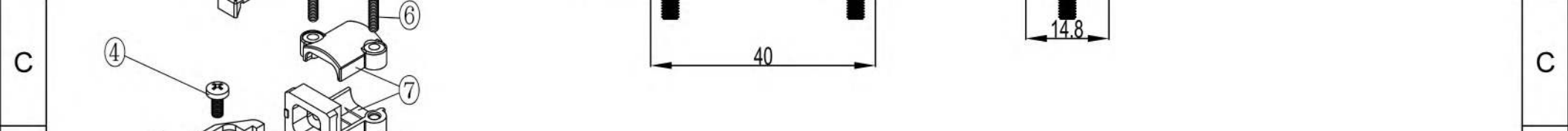
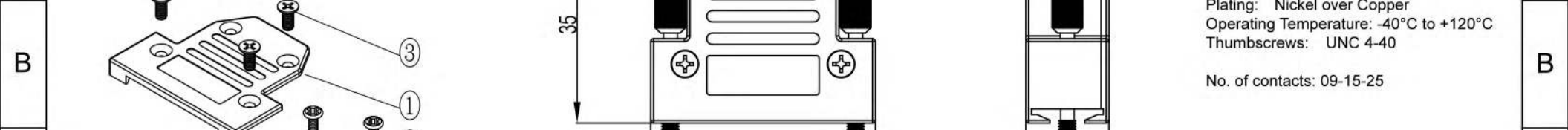
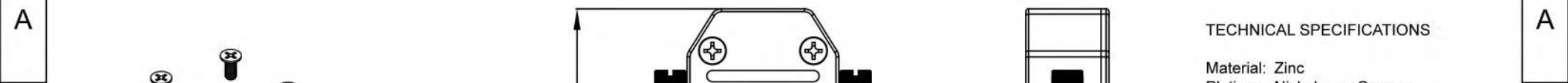

B B

C C

D D

E E

F F

TECHNICAL SPECIFICATIONS

Material: Zinc  
 Plating: Nickel over Copper  
 Operating Temperature: -40°C to +120°C  
 Thumbscrews: UNC 4-40  
  
 No. of contacts: 09-15-25

Item	QTY	Part description
1	1	Upper Cover
2	1	Lower Cover
3	4	M2.5x6 CSK Screw
4	1	M2.5x6 Pozi Screw
5	2	UNC 4-40x24 Jackscrew
6	2	M2.5x10 Screw
7	1	Cable Strain Relief

**RoHS compliant**  
 Unit: mm

Scale	Free				Date	Name	Customer-No.
TOLERANCE					Drawn	17.08.2017	S.Bölling
0~6	±0.10				Approved	17.08.2017	S.Bölling
6~30	±0.20						
30~120	±0.30						
120~400	±0.50						
DIM	Tol						
Angle	±1°	Ⓢ	Drawn	17.08.2017	S.Bölling	ASSMANN WSW-No. <b>ACOV-SUB-15MB7</b>	
Angle	Tol	Id.	Modification	Date	Name	Drawing-No. <b>ASS_5248_CO</b> rev00	
						Replace Sheet 2/3	



1 2 3 4 5 6 7

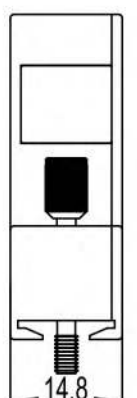
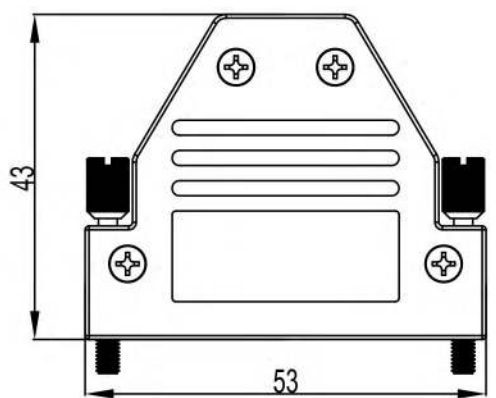
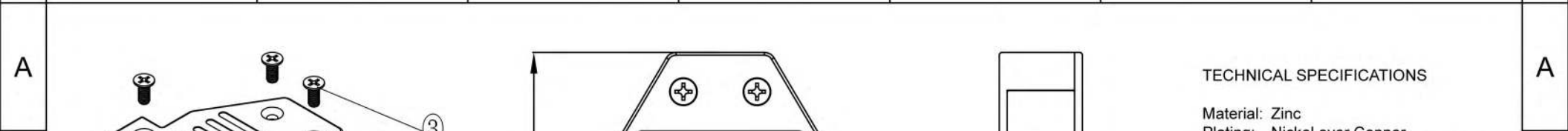

**TECHNICAL SPECIFICATIONS**

Material: Zinc  
 Plating: Nickel over Copper  
 Operating Temperature: -40°C to +120°C  
 Thumbscrews: UNC 4-40  
  
 No. of contacts: 09-15-25

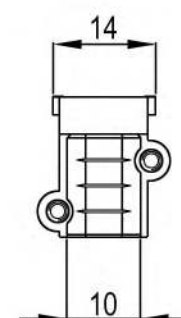
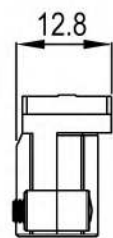
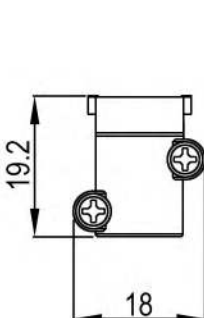
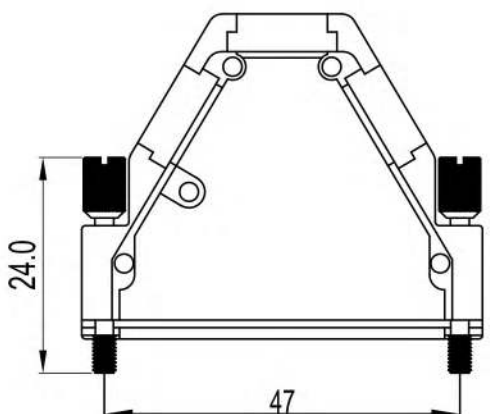
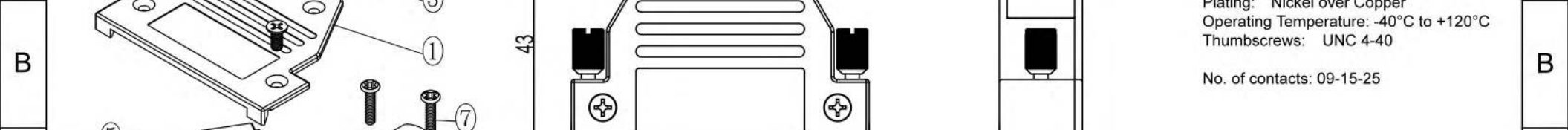

Item	QTY	Part description
1	1	Upper Cover
2	1	Lower Cover
3	4	M2.5x6 CSK Screw
4	1	M2.5x6 Pozi Screw
5	2	Blanker
6	2	UNC 4-40x24 Jackscrew
7	2	M2.5x10 Screw
8	1	Cable Strain Relief

**RoHS compliant**  
 Unit: mm

Scale	Free				Date	Name	Customer-No.	
TOLERANCE					Drawn	17.08.2017	S.Bölling	
0~6	±0.10				Approved	17.08.2017	S.Bölling	
6~30	±0.20							
30~120	±0.30							
120~400	±0.50							
DIM	Tol							
Angle	±1°	Ⓢ	Drawn	17.08.2017				S.Bölling
Angle	Tol	Id.	Modification	Date				Name

Customer-No.  
  
 ASSMANN WSW-No.  
**ACOV-SUB-25MB7**

Drawing-No.  
**ASS\_5248\_CO** rev00  
 Replace  
 Sheet 3/3