

RECOMMENDED PCB(CONNECTOR SIDE VIEW)
THICKNESS=1.6 TO 2.4 MM

FUNCTIONAL SYMBOLS	THIS DRAWING CONTAINS INFORMATION THAT IS PROPRIETARY TO MOLEX ELECTRONIC TECHNOLOGIES, LLC AND SHOULD NOT BE USED WITHOUT WRITTEN PERMISSION		CURRENT REV DESC:		molex
	GENERAL TOLERANCES (UNLESS SPECIFIED)	ANGULAR TOL ± 3.0°	EC NO: 697101		
DIVISIONAL SYMBOLS	4 PLACES ±	3 PLACES ± 0.1	DRWN: GLLI	2022/02/24	PRODUCT CUSTOMER DRAWING
	2 PLACES ± 0.2	1 PLACE ± 0.3	CHK'D: XQZHANG	2022/02/25	
	0 PLACES ±		APPR: XQZHANG	2022/02/25	DOC TYPE: PSD
	DRAFT WHERE APPLICABLE MUST REMAIN WITHIN DIMENSIONS	THIRD ANGLE PROJECTION	DRAWING: A3-SIZE	SERIES: 105312	MATERIAL NUMBER: GENERAL MARKET
			INITIAL REVISION:	2019/09/24	REVISION: B1
			DRWN: GLLI	2020/03/16	SHEET NUMBER: 1 OF 5
			APPR: YXZHENG		

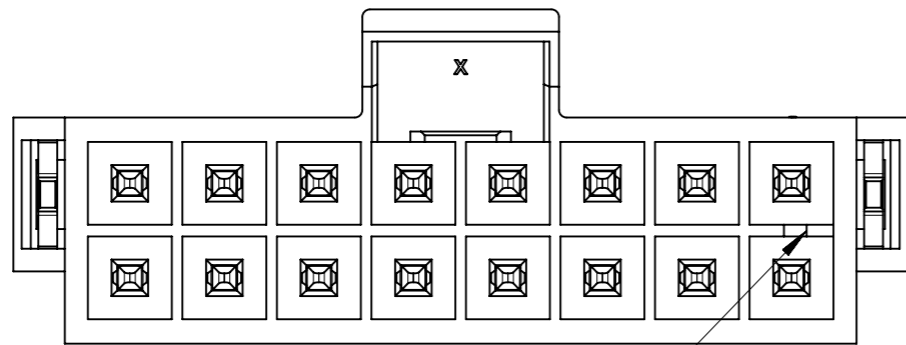

KEY A



KEY A

BLACK

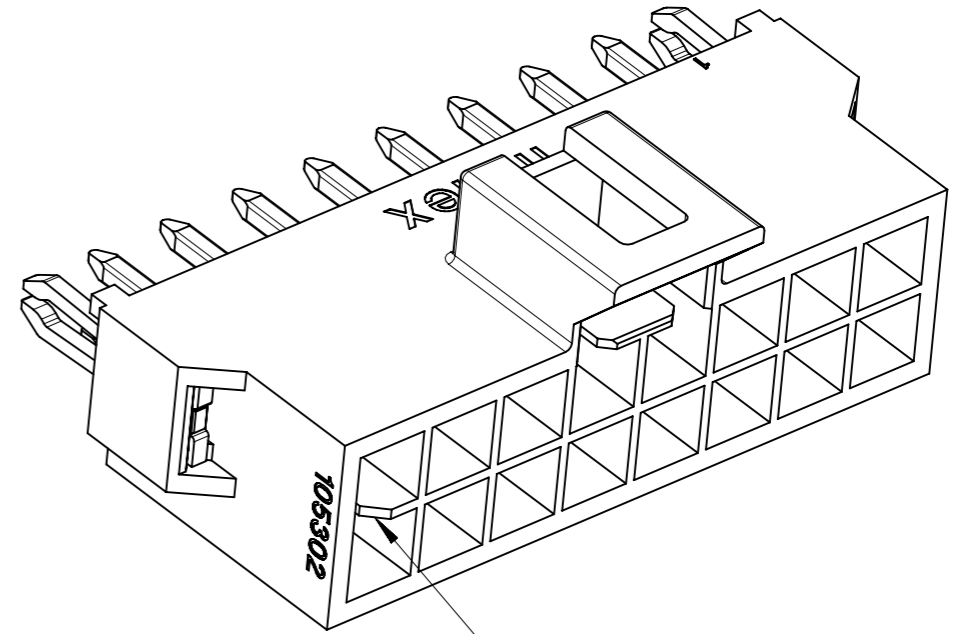

KEY B

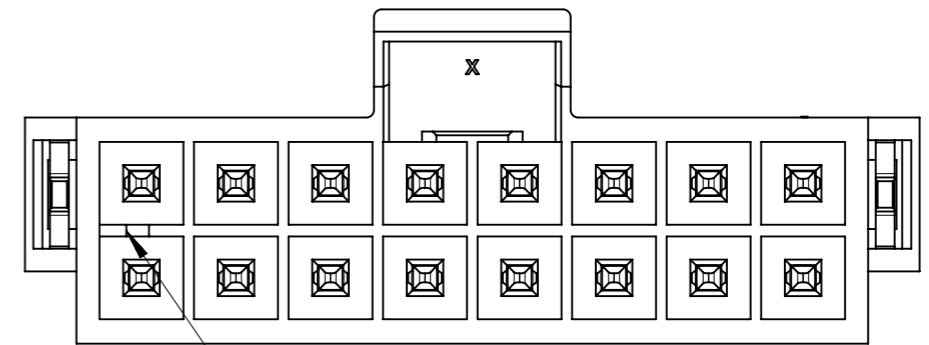

KEY B

NATURAL

COLOR OPTION

FUNCTIONAL SYMBOLS	THIS DRAWING CONTAINS INFORMATION THAT IS PROPRIETARY TO MOLEX ELECTRONIC TECHNOLOGIES, LLC AND SHOULD NOT BE USED WITHOUT WRITTEN PERMISSION		CURRENT REV DESC:		molex				
	▽A = 0	mm						SCALE 5:1	
▽E = 0	GENERAL TOLERANCES (UNLESS SPECIFIED)		EC NO: 697101 DRWN: GLLI 2022/02/24 CHK'D: XQZHANG 2022/02/25 APPR: XQZHANG 2022/02/25 INITIAL REVISION: DRWN: GLLI 2019/09/24 APPR: YXZHENG 2020/03/16		HEADER OF NANO-FIT, D/R, CLIP, VERTICAL POWER CONNECTOR				
▽V = 0	ANGULAR TOL ± 3.0°				PRODUCT CUSTOMER DRAWING				
DIVISIONAL SYMBOLS	4 PLACES	±				DOCUMENT NUMBER	DOC TYPE	DOC PART	REVISION
	3 PLACES	±			0.1	1053121000-SD	PSD	000	B1
	2 PLACES	±			0.2	MATERIAL NUMBER		CUSTOMER	
	1 PLACE	±	0.3	105312		GENERAL MARKET			
	0 PLACES	±		SERIES		SHEET NUMBER			
	DRAFT WHERE APPLICABLE MUST REMAIN WITHIN DIMENSIONS		THIRD ANGLE PROJECTION	DRAWING	A3-SIZE		2 OF 5		

DOCUMENT STATUS	P1	RELEASE DATE	2022/02/25	03:08:44
-----------------	----	--------------	------------	----------

10	9	8	7	6	5	4	3	2	1
PART NUMBER	DIM 'A'	DIM 'B'	DIM 'C'	CKT SIZE	PLATING	MYLAR			
105312-3504	8.66	5.94	6.84	4	TIN				
105312-3506	11.16	8.44	9.34	6					
105312-3508	13.66	10.94	11.84	8					
105312-3510	16.16	13.44	14.34	10					
105312-3512	18.66	15.94	16.84	12					
105312-3514	21.16	18.44	19.34	14					
105312-3516	23.66	20.94	21.84	16					
105312-3704	8.66	5.94	6.84	4					
105312-3706	11.16	8.44	9.34	6					
105312-3708	13.66	10.94	11.84	8					
105312-3710	16.16	13.44	14.34	10					
105312-3712	18.66	15.94	16.84	12					
105312-3714	21.16	18.44	19.34	14					
105312-3716	23.66	20.94	21.84	16					
105312-3604	8.66	5.94	6.84	4	GOLD 0.76	YES			
105312-3606	11.16	8.44	9.34	6					
105312-3608	13.66	10.94	11.84	8					
105312-3610	16.16	13.44	14.34	10					
105312-3612	18.66	15.94	16.84	12					
105312-3614	21.16	18.44	19.34	14					
105312-3616	23.66	20.94	21.84	16					
105312-3804	8.66	5.94	6.84	4					GOLD 0.76 + LUBE
105312-3806	11.16	8.44	9.34	6					
105312-3808	13.66	10.94	11.84	8					
105312-3810	16.16	13.44	14.34	10					
105312-3812	18.66	15.94	16.84	12					
105312-3814	21.16	18.44	19.34	14					
105312-3816	23.66	20.94	21.84	16					
COLOR: BLACK									

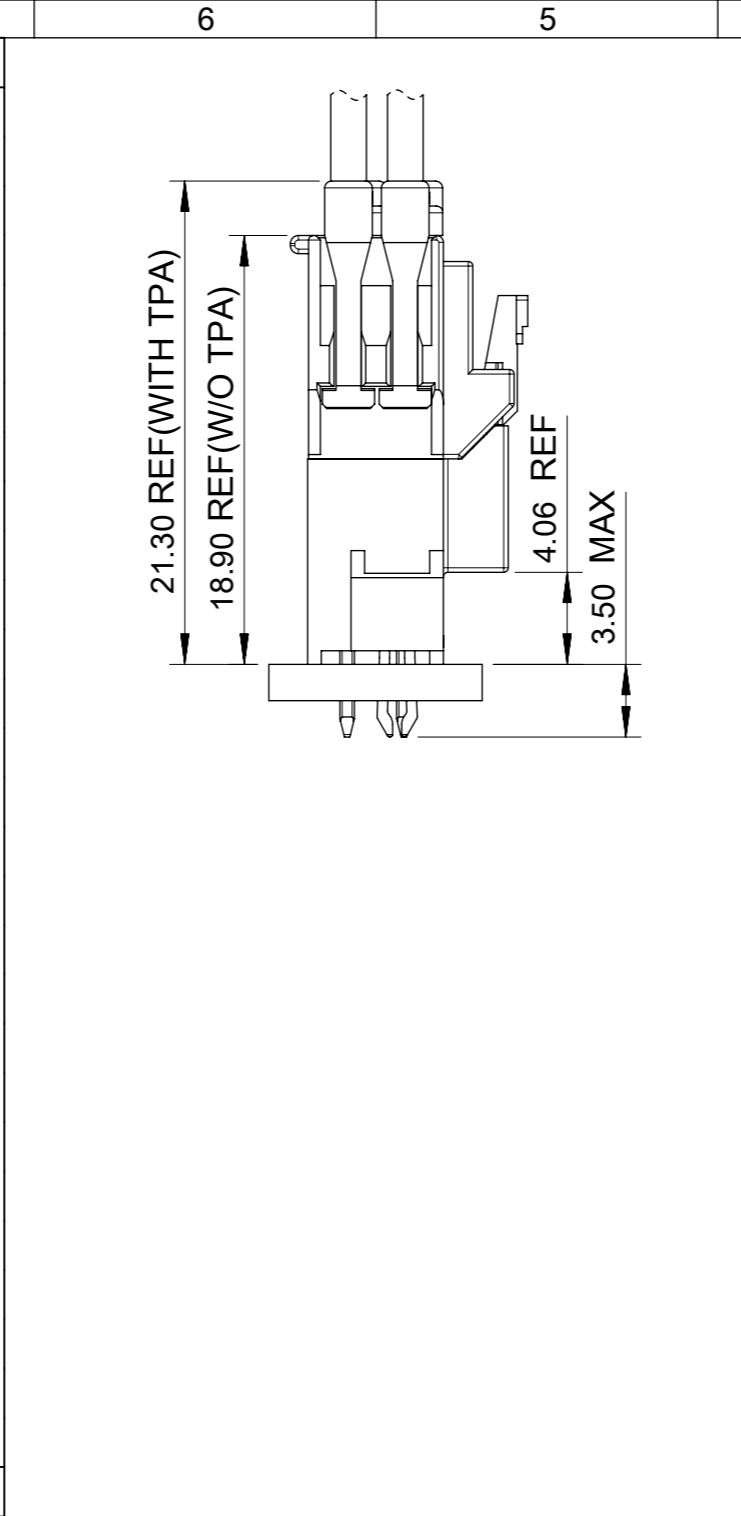

10	9	8	7	6	5	4	3	2	1
PART NUMBER	DIM 'A'	DIM 'B'	DIM 'C'	CKT SIZE	PLATING	MYLAR			
105312-4504	8.66	5.94	6.84	4	TIN				
105312-4506	11.16	8.44	9.34	6					
105312-4508	13.66	10.94	11.84	8					
105312-4510	16.16	13.44	14.34	10					
105312-4512	18.66	15.94	16.84	12					
105312-4514	21.16	18.44	19.34	14					
105312-4516	23.66	20.94	21.84	16					
105312-4704	8.66	5.94	6.84	4					
105312-4706	11.16	8.44	9.34	6					
105312-4708	13.66	10.94	11.84	8					
105312-4710	16.16	13.44	14.34	10					
105312-4712	18.66	15.94	16.84	12					
105312-4714	21.16	18.44	19.34	14					
105312-4716	23.66	20.94	21.84	16					
105312-4604	8.66	5.94	6.84	4	GOLD 0.76	YES			
105312-4606	11.16	8.44	9.34	6					
105312-4608	13.66	10.94	11.84	8					
105312-4610	16.16	13.44	14.34	10					
105312-4612	18.66	15.94	16.84	12					
105312-4614	21.16	18.44	19.34	14					
105312-4616	23.66	20.94	21.84	16					
105312-4804	8.66	5.94	6.84	4					GOLD 0.76 + LUBE
105312-4806	11.16	8.44	9.34	6					
105312-4808	13.66	10.94	11.84	8					
105312-4810	16.16	13.44	14.34	10					
105312-4812	18.66	15.94	16.84	12					
105312-4814	21.16	18.44	19.34	14					
105312-4816	23.66	20.94	21.84	16					
COLOR: NATURAL									

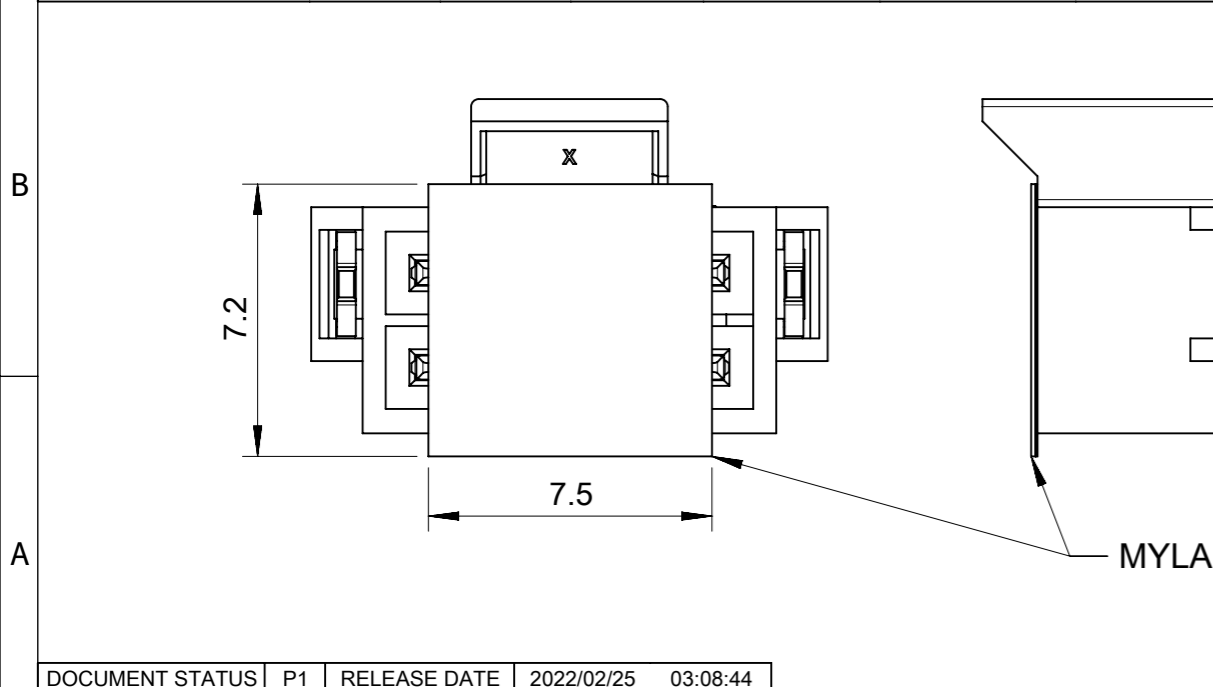

FUNCTIONAL SYMBOLS	THIS DRAWING CONTAINS INFORMATION THAT IS PROPRIETARY TO MOLEX ELECTRONIC TECHNOLOGIES, LLC AND SHOULD NOT BE USED WITHOUT WRITTEN PERMISSION	CURRENT REV DESC:		molex					
	<table border="1"> <tr><td>DIMENSION UNITS</td><td>SCALE</td></tr> <tr><td>mm</td><td>5:1</td></tr> </table>	DIMENSION UNITS	SCALE		mm	5:1	EC NO: 697101		2022/02/24
	DIMENSION UNITS	SCALE							
	mm	5:1							
GENERAL TOLERANCES (UNLESS SPECIFIED)	DRWN: GLLI	2022/02/25							
ANGULAR TOL ± 3.0°	3 PLACES ± 0.1	CHK'D: XQZHANG	2022/02/25						
4 PLACES ±	2 PLACES ± 0.2	APPR: XQZHANG							
DIVISIONAL SYMBOLS	1 PLACE ± 0.3	INITIAL REVISION:	2019/09/24	DOCUMENT NUMBER					
0 PLACES ±	DRAFT WHERE APPLICABLE MUST REMAIN WITHIN DIMENSIONS	DRWN: GLLI	2020/03/16	1053121000-SD					
	THIRD ANGLE PROJECTION	APPR: YXZHENG		DOC TYPE					
				PSD					
				DOC PART					
				000					
				REVISION					
				B1					
				MATERIAL NUMBER					
				105312					
				CUSTOMER					
				GENERAL MARKET					
				SHEET NUMBER					
				3 OF 5					

		4 CKT	6 CKT	8 CKT	10 CKT
F	BLACK				
E	NATURAL				
		12 CKT	14 CKT	16 CKT	
D	BLACK				
C	NATURAL				

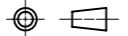
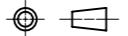
FUNCTIONAL SYMBOLS $\nabla_A = 0$ $\nabla_E = 0$ $\nabla_V = 0$	THIS DRAWING CONTAINS INFORMATION THAT IS PROPRIETARY TO MOLEX ELECTRONIC TECHNOLOGIES, LLC AND SHOULD NOT BE USED WITHOUT WRITTEN PERMISSION DIMENSION UNITS: mm SCALE: 3:1	CURRENT REV DESC: EC NO: 697101 DRWN: GLLI CHK'D: XQZHANG APPR: XQZHANG INITIAL REVISION: DRWN: GLLI APPR: YXZHENG	 HEADER OF NANO-FIT, D/R, CLIP, VERTICAL POWER CONNECTOR		
	GENERAL TOLERANCES (UNLESS SPECIFIED) ANGULAR TOL $\pm 3.0^\circ$ 4 PLACES \pm 3 PLACES ± 0.1 2 PLACES ± 0.2 1 PLACE ± 0.3 0 PLACES \pm				
DIVISIONAL SYMBOLS 4 PLACES \pm 3 PLACES ± 0.1 2 PLACES ± 0.2 1 PLACE ± 0.3 0 PLACES \pm	DRAFT WHERE APPLICABLE MUST REMAIN WITHIN DIMENSIONS THIRD ANGLE PROJECTION 	DRAWING: A3-SIZE SERIES: 105312	DOCUMENT NUMBER: 1053121000-SD MATERIAL NUMBER:	DOC TYPE: PSD DOC PART: 000 REVISION: B1	CUSTOMER: GENERAL MARKET SHEET NUMBER: 4 OF 5

NOTES FOR ALL PARTS

1> MATERIAL:
 HOUSING: LCP, UL 94V-0.
 TERMINAL: BRASS.
 SOLDER CLIP: BRASS.

2> PLATING FINISHED:
 TERMINAL:
 CONTACT AREA: a. REFLOW MATTE TIN 1.5MICRONS MIN;
 b. GOLD 0.38 MICRONS MIN;
 c. GOLD 0.76 MICRONS MIN.
 SOLDER AREA: MATTE TIN 1.5 MICRONS MIN, UNDER PLATING NICKEL 1.25
 MICRONS MIN.
 SOLDER CLIP: MATTE TIN 2.5 MICRONS MIN, UNDER PLATING NICKEL 1.25
 MICRONS MIN.

3> PRODUCT SPECIFICATION: PS-105300-100.
 4> PACKAGE: TAPE REEL, 1053121000-PK.
 5> PRODUCT MATE WITH SERIES OF 105308(RECEPTACLE), 105300(CRIMP TERMINAL).
 6> PARTS CONFORM TO CLASS 'B'REQUIREMENTS OF COSMETIC SPECIFICATION
 PS-45499-002.
 7> DISCOLORATION IN THE BANDOLIER PIN CARRIER AREA OF THE PIN IS INHERENT TO
 THE PLATING PROCESS AND IS DUE TO THE MASKING DEFECT OF THE CARRIER, THIS
 DISCOLORATION IS IN A NON-FUNCTION AREA OF THE PIN AND WILL NOT AFFECT
 THE PERFORMANCE OF THE HEADER ASSEMBLY.

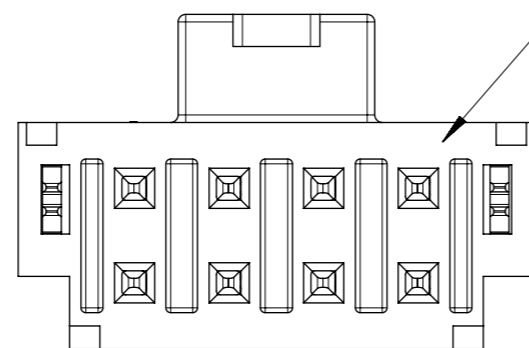

IF ANY NUMBER MARK APPEARS ON THIS SURFACE,
 PLEASE DISREGARD IT, IT IS NO ANY FUCTION AND
 NO ANY RELATION TO PIN NUMBER, IT IS JUST FOR
 MOLDING IDENDIFICATION.

FUNCTIONAL SYMBOLS	THIS DRAWING CONTAINS INFORMATION THAT IS PROPRIETARY TO MOLEX ELECTRONIC TECHNOLOGIES, LLC AND SHOULD NOT BE USED WITHOUT WRITTEN PERMISSION		CURRENT REV DESC:		molex				
	△/A = 0	mm							SCALE 1:1
DIVISIONAL SYMBOLS	GENERAL TOLERANCES (UNLESS SPECIFIED)		EC NO: 697101 DRWN: GLLI 2022/02/24 CHK'D: XQZHANG 2022/02/25 APPR: XQZHANG 2022/02/25		HEADER OF NANO-FIT, D/R, CLIP, VERTICAL POWER CONNECTOR				
	△/E = 0	ANGULAR TOL ± 3.0°			PRODUCT CUSTOMER DRAWING				
DIVISIONAL SYMBOLS	4 PLACES	±	INITIAL REVISION: DRWN: GLLI 2019/09/24 APPR: YXZHENG 2020/03/16		DOCUMENT NUMBER	DOC TYPE	DOC PART	REVISION	
	3 PLACES	±			1053121000-SD	PSD	000	B1	
	2 PLACES	±			MATERIAL NUMBER		CUSTOMER		SHEET NUMBER
	1 PLACE	±			A3-SIZE 105312		GENERAL MARKET		5 OF 5
0 PLACES	±	DRAFT WHERE APPLICABLE MUST REMAIN WITHIN DIMENSIONS		THIRD ANGLE PROJECTION					