

MM74C00 • MM74C02 • MM74C04

Quad 2-Input NAND Gate • Quad 2-Input NOR Gate • Hex Inverter

General Description

The MM74C00, MM74C02, and MM74C04 logic gates employ complementary MOS (CMOS) to achieve wide power supply operating range, low power consumption, high noise immunity and symmetric controlled rise and fall times. With features such as this the 74C logic family is close to ideal for use in digital systems. Function and pin out compatibility with series 74 devices minimizes design time for those designers already familiar with the standard 74 logic family.

All inputs are protected from damage due to static discharge by diode clamps to V_{CC} and GND.

Features

- Wide supply voltage range: 3V to 15V
- Guaranteed noise margin: 1V
- High noise immunity: $0.45 V_{CC}$ (typ.)
- Low power consumption: 10 nW/package (typ.)
- Low power: TTL compatibility:
Fan out of 2 driving 74L

Ordering Code:

| Order Number | Package Number | Package Description |
|--------------|----------------|--|
| MM74C00M | M14A | 14-Lead Small Outline Integrated Circuit (SOIC), JEDEC MS-012, 0.150" Narrow |
| MM74C00N | N14A | 14-Lead Plastic Dual-In-Line Package (PDIP), JEDEC MS-001, 0.300" Wide |
| MM74C02N | N14A | 14-Lead Plastic Dual-In-Line Package (PDIP), JEDEC MS-001, 0.300" Wide |
| MM74C04M | M14A | 14-Lead Small Outline Integrated Circuit (SOIC), JEDEC MS-012, 0.150" Narrow |
| MM74C04N | N14A | 14-Lead Plastic Dual-In-Line Package (PDIP), JEDEC MS-001, 0.300" Wide |

Device also available in Tape and Reel. Specify by appending suffix letter "X" to the ordering code.

Connection Diagrams

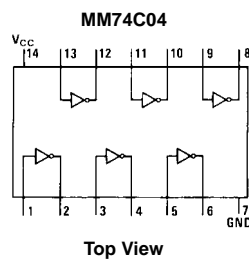
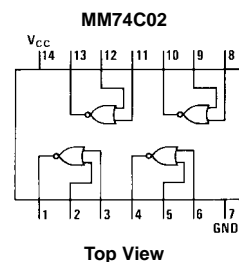
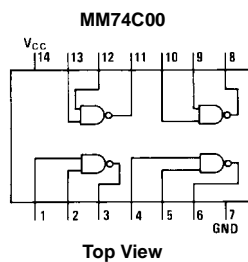

Absolute Maximum Ratings(Note 1)

| | |
|---|--------------------------|
| Voltage at Any Pin | -0.3V to $V_{CC} + 0.3V$ |
| Operating Temperature Range | -55°C to +125°C |
| Storage Temperature Range | -65°C to +150°C |
| Operating V_{CC} Range | 3.0V to 15V |
| Maximum V_{CC} Voltage | 18V |
| Power Dissipation (P_D) | |
| Dual-In-Line | 700 mW |
| Small Outline | 500 mW |
| Lead Temperature (Soldering, 10 seconds) | 300°C |

Note 1: "Absolute Maximum Ratings" are those values beyond which the safety of the device cannot be guaranteed. Except for "Operating Temperature Range" they are not meant to imply that the devices should be operated at these limits. The table of "Electrical Characteristics" provides conditions for actual device operation.

DC Electrical Characteristics

Min/Max limits apply across the guaranteed temperature range unless otherwise noted

| Symbol | Parameter | Conditions | Min | Typ | Max | Units |
|---|----------------------------|---|----------------|--------|-----|---------|
| CMOS TO CMOS | | | | | | |
| $V_{IN(1)}$ | Logical "1" Input Voltage | $V_{CC} = 5.0V$ | 3.5 | | | V |
| | | $V_{CC} = 10V$ | 8.0 | | | |
| $V_{IN(0)}$ | Logical "0" Input Voltage | $V_{CC} = 5.0V$ | | | 1.5 | V |
| | | $V_{CC} = 10V$ | | | 2.0 | |
| $V_{OUT(1)}$ | Logical "1" Output Voltage | $V_{CC} = 5.0V, I_O = -10 \mu A$ | 4.5 | | | V |
| | | $V_{CC} = 10V, I_O = -10 \mu A$ | 9.0 | | | |
| $V_{OUT(0)}$ | Logical "0" Output Voltage | $V_{CC} = 5.0V, I_O = 10 \mu A$ | | | 0.5 | V |
| | | $V_{CC} = 10V, I_O = 10 \mu A$ | | | 1.0 | |
| $I_{IN(1)}$ | Logical "1" Input Current | $V_{CC} = 15V, V_{IN} = 15V$ | | 0.005 | 1.0 | μA |
| $I_{IN(0)}$ | Logical "0" Input Current | $V_{CC} = 15V, V_{IN} = 0V$ | -1.0 | -0.005 | | μA |
| I_{CC} | Supply Current | $V_{CC} = 15V$ | | 0.01 | 15 | μA |
| LOW POWER TO CMOS | | | | | | |
| $V_{IN(1)}$ | Logical "1" Input Voltage | 74C, $V_{CC} = 4.75V$ | $V_{CC} - 1.5$ | | | V |
| $V_{IN(0)}$ | Logical "0" Input Voltage | 74C, $V_{CC} = 4.75V$ | | | 0.8 | V |
| $V_{OUT(1)}$ | Logical "1" Output Voltage | 74C, $V_{CC} = 4.75V, I_O = -10 \mu A$ | 4.4 | | | V |
| $V_{OUT(0)}$ | Logical "0" Output Voltage | 74C, $V_{CC} = 4.75V, I_O = 10 \mu A$ | | | 0.4 | V |
| CMOS TO LOW POWER | | | | | | |
| $V_{IN(1)}$ | Logical "1" Input Voltage | 74C, $V_{CC} = 4.75V$ | 4.0 | | | V |
| $V_{IN(0)}$ | Logical "0" Input Voltage | 74C, $V_{CC} = 4.75V$ | | | 1.0 | V |
| $V_{OUT(1)}$ | Logical "1" Output Voltage | 74C, $V_{CC} = 4.75V, I_O = -360 \mu A$ | 2.4 | | | V |
| $V_{OUT(0)}$ | Logical "0" Output Voltage | 74C, $V_{CC} = 4.75V, I_O = 360 \mu A$ | | | 0.4 | V |
| OUTPUT DRIVE (see Family Characteristics Data Sheet) TA = 25°C (short circuit current) | | | | | | |
| I_{SOURCE} | Output Source Current | $V_{CC} = 5.0V, V_{IN(0)} = 0V, V_{OUT} = 0V$ | -1.75 | | | mA |
| I_{SOURCE} | Output Source Current | $V_{CC} = 10V, V_{IN(0)} = 0V, V_{OUT} = 0V$ | -8.0 | | | mA |
| I_{SINK} | Output Sink Current | $V_{CC} = 5.0V, V_{IN(1)} = 5.0V, V_{OUT} = V_{CC}$ | 1.75 | | | mA |
| I_{SINK} | Output Sink Current | $V_{CC} = 10V, V_{IN(1)} = 10V, V_{OUT} = V_{CC}$ | 8.0 | | | mA |

AC Electrical Characteristics (Note 2)

$T_A = 25^\circ C, C_L = 50 \text{ pF}$, unless otherwise specified

| Symbol | Parameter | Conditions | Min | Typ | Max | Units |
|----------------------------------|--|-------------------------------|-----|-----|-----|-------|
| MM74C00, MM74C02, MM74C04 | | | | | | |
| t_{pd0}, t_{pd1} | Propagation Delay Time to Logical "1" or "0" | $V_{CC} = 5.0V$ | | 50 | 90 | ns |
| | | $V_{CC} = 10V$ | | 30 | 60 | |
| C_{IN} | Input Capacitance | (Note 3) | | 6.0 | | pF |
| C_{PD} | Power Dissipation Capacitance | Per Gate or Inverter (Note 4) | | 12 | | pF |

Note 2: AC Parameters are guaranteed by DC correlated testing.

Note 3: Capacitance is guaranteed by periodic testing.

Note 4: C_{PD} determines the no load AC power consumption of any CMOS device. For complete explanation see Family Characteristics Application Note—AN-90.

Typical Performance Characteristics

Gate Transfer Characteristics

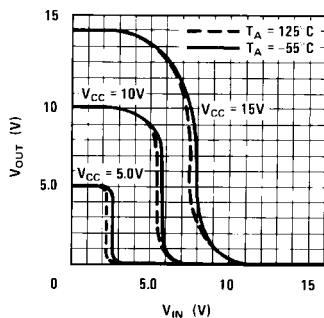

Propagation Delay vs. Ambient Temperature
MM74C00, MM74C02, MM74C04

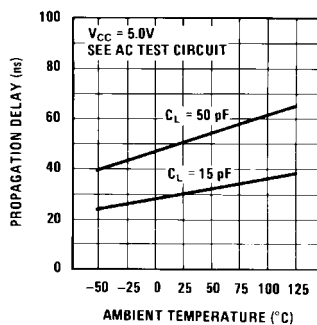

Guaranteed Noise Margin Over Temperature vs. V_{CC}

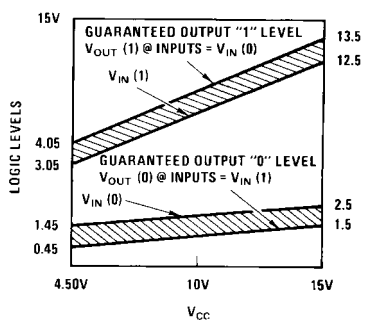

Propagation Delay vs. Ambient Temperature
MM74C00, MM74C02, MM74C04

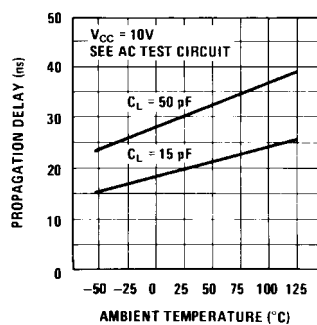

Power Dissipation vs. Frequency
MM74C00, MM74C02, MM74C04

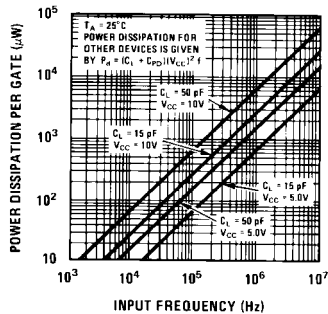

Propagation Delay Time vs. Load Capacitance
MM74C00, MM74C02, MM74C04

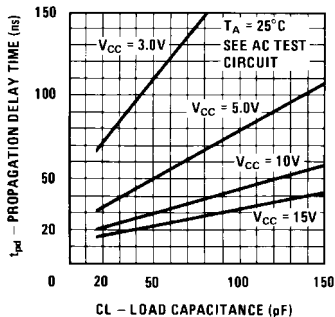

Switching Time Waveforms and AC Test Circuit

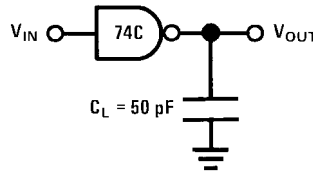
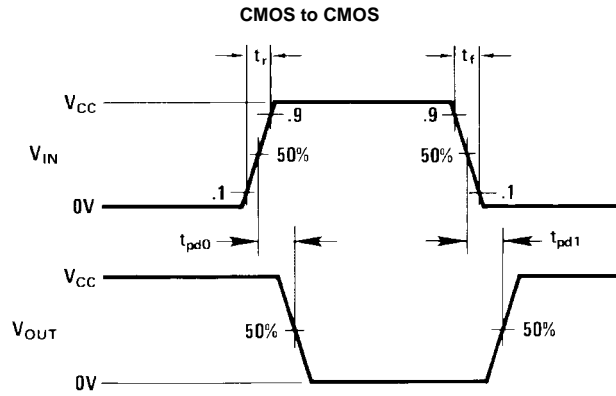

Delays measured with input $t_r, t_f \leq 20$ ns.

Physical Dimensions inches (millimeters) unless otherwise noted

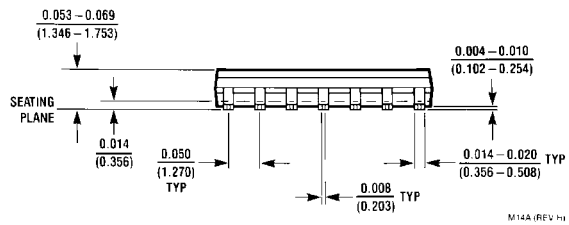
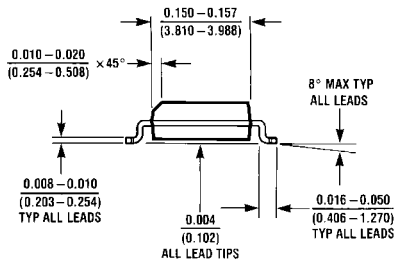
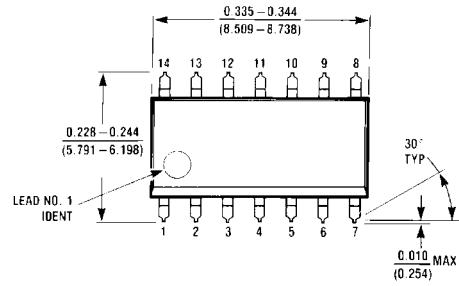

**14-Lead Small Outline Integrated Circuit (SOIC), JEDEC MS-012, 0.150" Narrow
Package Number M14A**

MM74C00 • MM74C02 • MM74C04

M14A (REV. H)

Physical Dimensions inches (millimeters) unless otherwise noted (Continued)

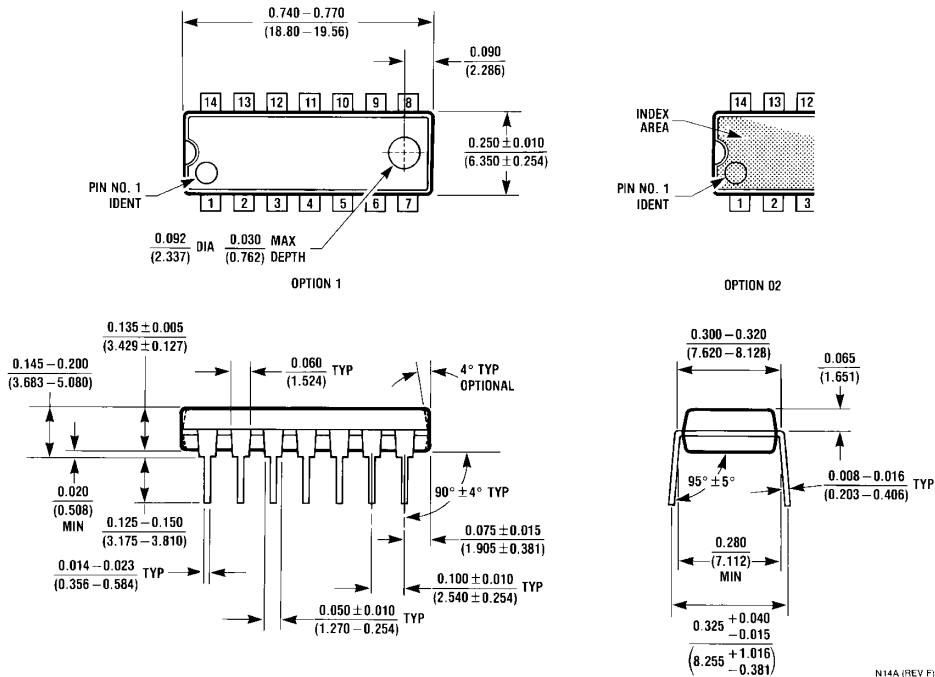

Fairchild does not assume any responsibility for use of any circuitry described, no circuit patent licenses are implied and Fairchild reserves the right at any time without notice to change said circuitry and specifications.

LIFE SUPPORT POLICY

FAIRCHILD'S PRODUCTS ARE NOT AUTHORIZED FOR USE AS CRITICAL COMPONENTS IN LIFE SUPPORT DEVICES OR SYSTEMS WITHOUT THE EXPRESS WRITTEN APPROVAL OF THE PRESIDENT OF FAIRCHILD SEMICONDUCTOR CORPORATION. As used herein:

1. Life support devices or systems are devices or systems which, (a) are intended for surgical implant into the body, or (b) support or sustain life, and (c) whose failure to perform when properly used in accordance with instructions for use provided in the labeling, can be reasonably expected to result in a significant injury to the user.
2. A critical component in any component of a life support device or system whose failure to perform can be reasonably expected to cause the failure of the life support device or system, or to affect its safety or effectiveness.

www.fairchildsemi.com