

Description

The DGD0211C single high speed / low side MOSFET and IGBT driver is capable of driving 1.9A of peak current. The DGD0211C logic inputs are compatible with standard TTL and CMOS levels (down to 3.3V) to interface easily with MCUs. The DGD0211C provides non-inverting and inverting inputs.

Because of fast propagation times of 35ns typical and rise/fall times of 15ns typical, the DGD0211C is well suited for high speed applications like switch mode power supplies and PFC circuits.

The DGD0211C is offered in TSOT25 package and the operating temperature extends from -40°C to +125°C.

Applications

- DC-DC Converters
- Line Drivers
- Motor Controls
- Switch Mode Power Supplies

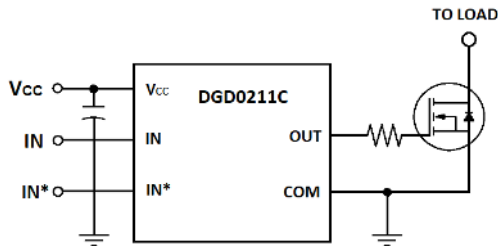

Typical Configuration

Features

- Efficient Low Cost Solution for Driving MOSFETs and IGBTs
- Wide Supply Voltage Operating Range: 4.5V to 18V
- 1.9A Source / 1.8A Sink Output Current Capability
- Non-Inverting and Inverting Input Configuration
- Fast Propagation Delay (35ns Typ)
- Fast Rise and Fall Times (15ns Typ)
- Logic Input (IN, IN*) 3.3V Capability
- Extended Temperature Range: -40°C to +125°C
- **Totally Lead-Free & Fully RoHS Compliant (Notes 1 & 2)**
- **Halogen and Antimony Free. "Green" Device (Note 3)**
- **For automotive applications requiring specific change control (i.e. parts qualified to AEC-Q100/101/200, PPAP capable, and manufactured in IATF 16949 certified facilities), please [contact us](mailto:contact@diodes.com) or your local Diodes representative.**
<https://www.diodes.com/quality/product-definitions/>

Mechanical Data

- Package: TSOT25 (Type TH)
- Package Material: Molded Plastic. "Green" Molding Compound. UL Flammability Classification Rating 94V-0
- Moisture Sensitivity: Level 3 per J-STD-020
- Terminals: Finish – Matte Tin Plated Leads. Solderable per MIL-STD-202, Method 208 Ⓔ3
- Weight: 0.012 grams (Approximate)

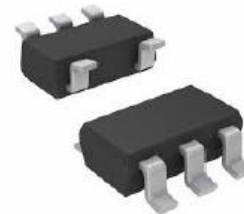

TSOT25

Ordering Information (Note 4)

Part Number	Marking	Reel Size (inches)	Tape Width (mm)	Packing	
				Qty.	Carrier
DGD0211CWT-7	D0211C	7	8	3,000	Reel

- Notes:
1. No purposely added lead. Fully EU Directive 2002/95/EC (RoHS), 2011/65/EU (RoHS 2) & 2015/863/EU (RoHS 3) compliant.
 2. See <https://www.diodes.com/quality/lead-free/> for more information about Diodes Incorporated's definitions of Halogen- and Antimony-free, "Green" and Lead-free.
 3. Halogen- and Antimony-free "Green" products are defined as those which contain <900ppm bromine, <900ppm chlorine (<1500ppm total Br + Cl) and <1000ppm antimony compounds.
 4. For packaging details, go to our website at <https://www.diodes.com/design/support/packaging/diodes-packaging/>.

Marking Information

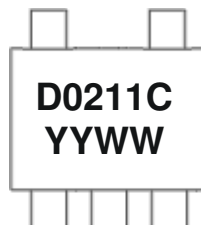

D0211C = Product Type Marking Code
YY = Year (ex: 21 = 2021)
WW = Week (01 to 53)

Pin Diagrams

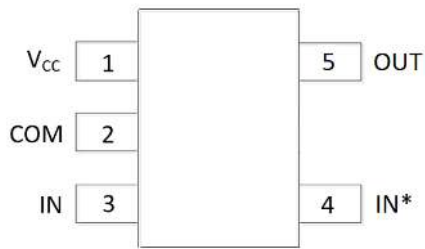

Top View TSOT25

Pin Descriptions

Pin Number	Pin Name	Function
1	V _{CC}	Supply Input
2	COM	Supply Return
3	IN	Non-Inverting Logic Input, see Input/Output Response Table (Connect to V _{CC} to Enable Output)
4	IN*	Inverting Logic Input, see Input/Output Response Table (Connect to COM to Enable Output)
5	OUT	Gate Drive Output

Functional Block Diagrams

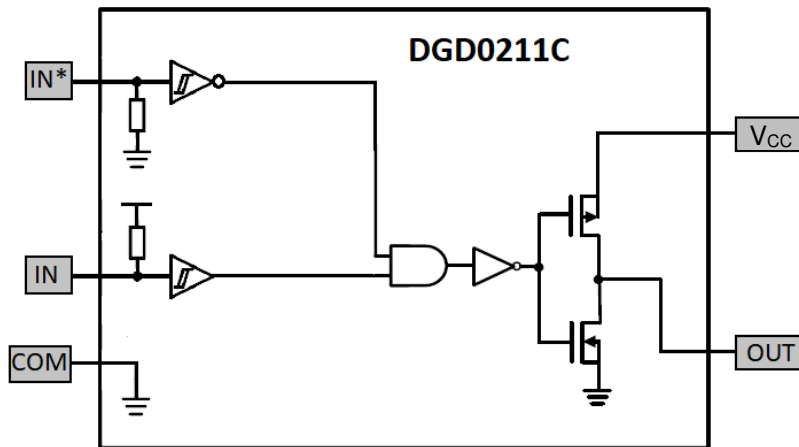

Absolute Maximum Ratings (@T_A = +25°C, unless otherwise specified.)

Characteristic	Symbol	Value	Unit
Low-Side Fixed Supply Voltage	V _{CC}	-0.3 to +22	V
Output Voltage (OUT)	V _{OUT}	-0.3 to V _{CC} +0.3	V
Logic Input Voltage (IN, IN*)	V _{IN}	-0.3 to V _{CC} +0.3	V

Thermal Characteristics (@T_A = +25°C, unless otherwise specified.)

Characteristic	Symbol	Value	Unit
Power Dissipation Linear Derating Factor (Note 5)	P _D	0.54	W
Thermal Resistance, Junction to Ambient (Note 5)	R _{θJA}	188	°C/W
Operating Temperature	T _J	+150	°C
Lead Temperature (Soldering, 10s)	T _L	+300	
Storage Temperature Range	T _{STG}	-55 to +150	

Note: 5. When mounted on a standard JEDEC 2-layer FR-4 board.

Recommended Operating Conditions

Parameter	Symbol	Min	Max	Unit
Supply Voltage	V _B	4.5	18	V
Output Voltage (OUT)	V _S	0	V _{CC}	V
Logic Input Voltage (IN, IN*)	V _{IN}	0	5	V
Ambient Temperature	T _A	-40	+125	°C

DC Electrical Characteristics (V_{BIAS} (V_{CC} , V_{BS}) = 12V, @ T_A = +25°C, unless otherwise specified.) (Note 6)

Parameter	Symbol	Min	Typ	Max	Unit	Conditions
Logic "1" Input Voltage	V_{IH}	2.4	1.6	—	V	—
Logic "0" Input Voltage	V_{IL}	—	1.3	0.8	V	—
Logic "1" Input Bias Current	I_{IN+}	—	—	5	μA	$V_{IN} = 3V$, $V_{IN^*} = 0V$
Logic "0" Input Bias Current	I_{IN-}	—	—	2	μA	$V_{IN} = 0V$, $V_{IN^*} = 3V$
High Level Output Voltage, $V_{BIAS} - V_O$	V_{OH}	—	25	—	mV	—
Low Level Output Voltage	V_{OL}	—	25	—	mV	—
Quiescent V_{CC} Supply Current	I_{CCQ}	—	50	100	μA	$V_{IN} = 0V$ or 3V
Output High Short Circuit Pulsed Current	I_{O+}	—	1.9	—	A	—
Output Low Short Circuit Pulsed Current	I_{O-}	—	1.8	—	A	—
Output Reverse Current Withstand	I_{RVS}	—	250	—	mA	—

Note: 6. The V_{IN} and I_{IN} parameters are applicable to the logic input pin: IN and IN*. The V_O and I_O parameters are applicable to the output pin: OUT.

AC Electrical Characteristics ($V_{CC} = 12V$, @ $T_A = +25^\circ C$, unless otherwise specified.)

Parameter	Symbol	Min	Typ	Max	Unit	Conditions
Turn-On Rise Time	t_r	—	15	25	ns	$C_L = 1000pF$
Turn-Off Fall Time	t_f	—	15	25	ns	$C_L = 1000pF$
Turn-On Propagation Delay	t_{ON}	—	35	50	ns	—
Turn-Off Propagation Delay	t_{OFF}	—	35	55	ns	—

Timing Waveforms

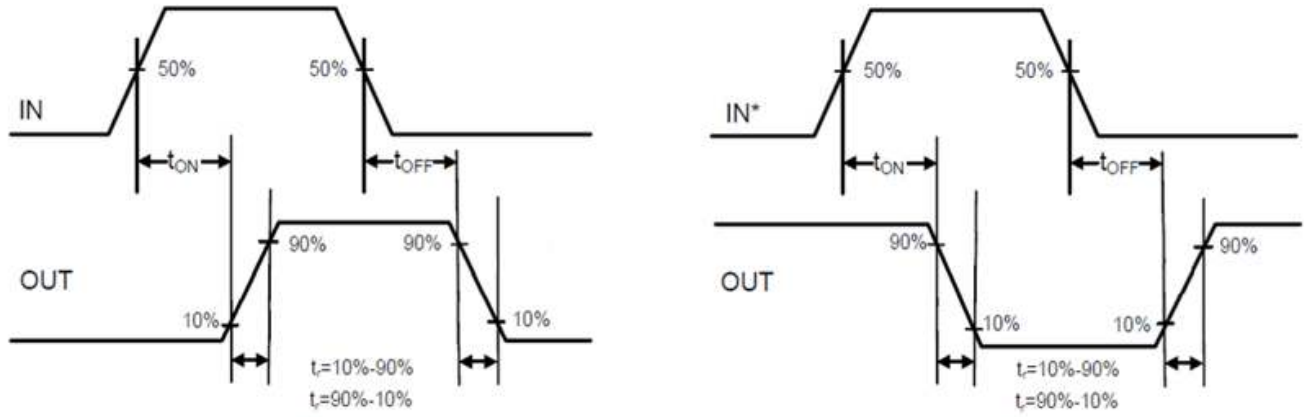

Figure 1. Switching Time Waveform Definitions

Input/Output Response Table

IN	IN*	OUT
0	0	0
0	1	0
1	0	1
1	1	0

Typical Performance Characteristics ($V_{CC} = 12V$, $@T_A = +25^\circ C$, unless otherwise specified.)

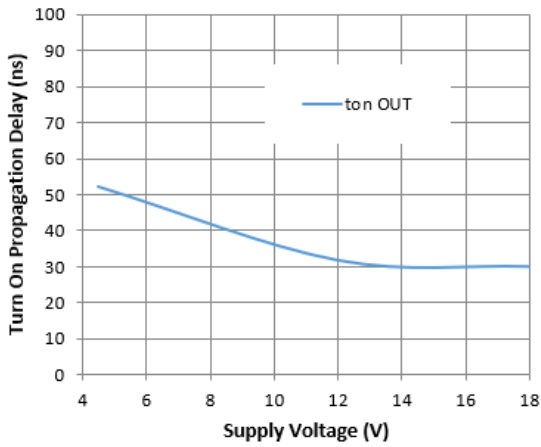

Figure 2. Turn-on Propagation Delay vs. Supply Voltage

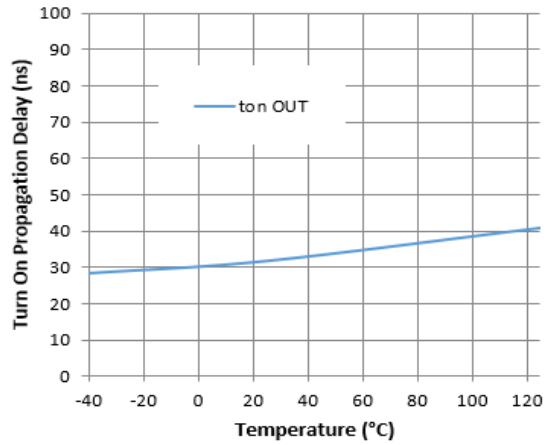

Figure 3. Turn-on Propagation Delay vs. Temperature

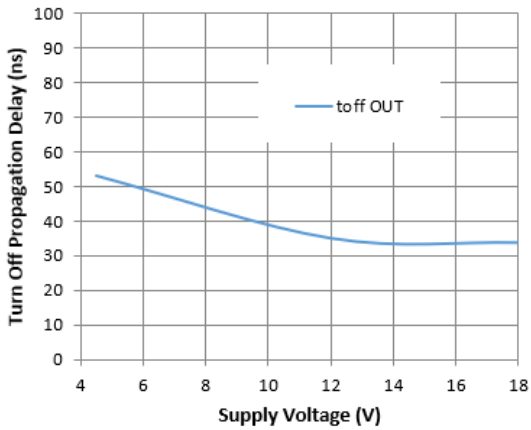

Figure 4. Turn-off Propagation Delay vs. Supply Voltage

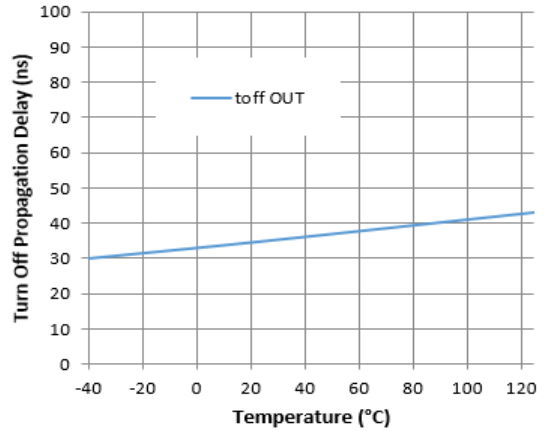

Figure 5. Turn-off Propagation Delay vs. Temperature

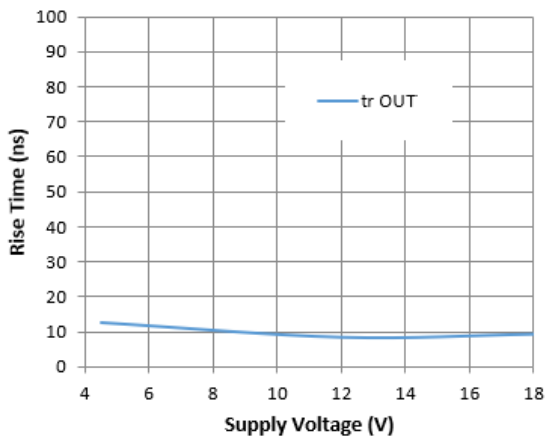

Figure 6. Rise Time vs. Supply Voltage

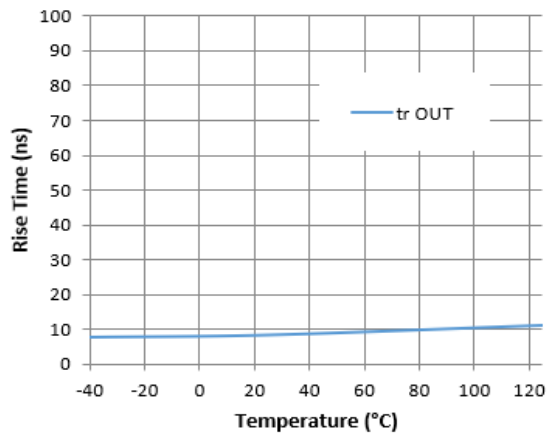

Figure 7. Rise Time vs. Temperature

Typical Performance Characteristics (continued)

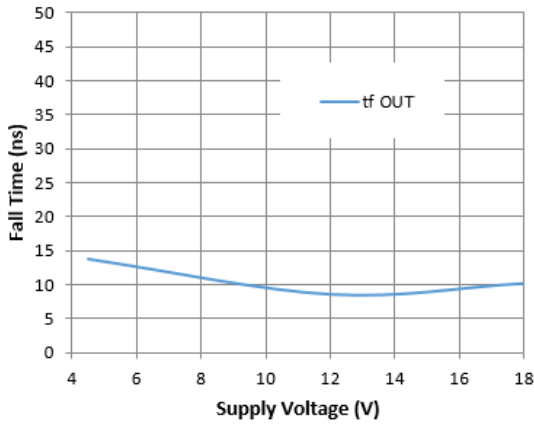

Figure 8. Fall Time vs. Supply Voltage

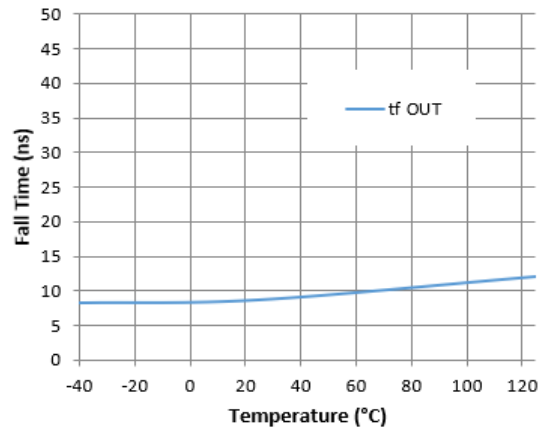

Figure 9. Fall Time vs. Temperature

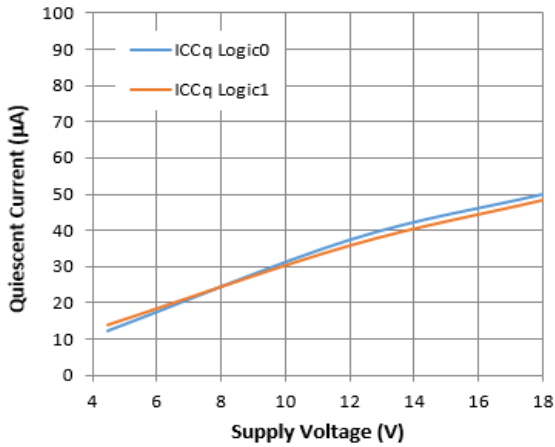

Figure 10. Quiescent Current vs. Supply Voltage

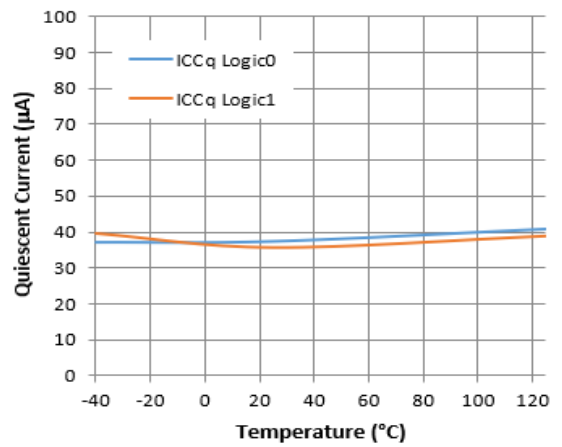

Figure 11. Quiescent Current vs. Temperature

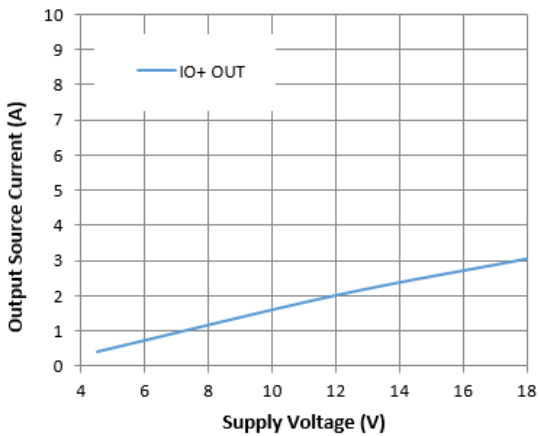

Figure 12. Output Source Current vs. Supply Voltage

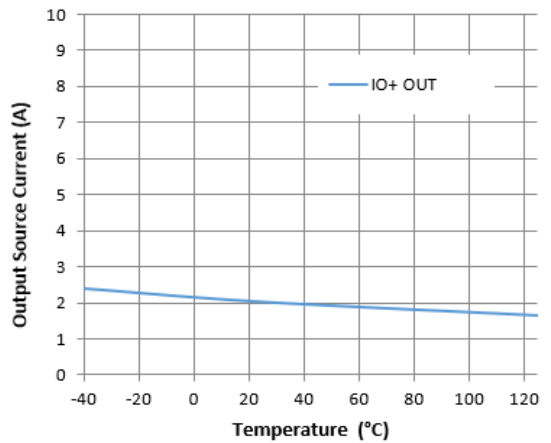

Figure 13. Output Source Current vs. Temperature

Typical Performance Characteristics (continued)

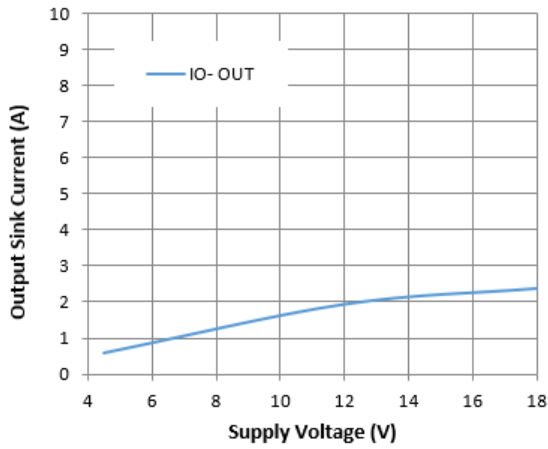

Figure 14. Output Sink Current vs. Supply Voltage

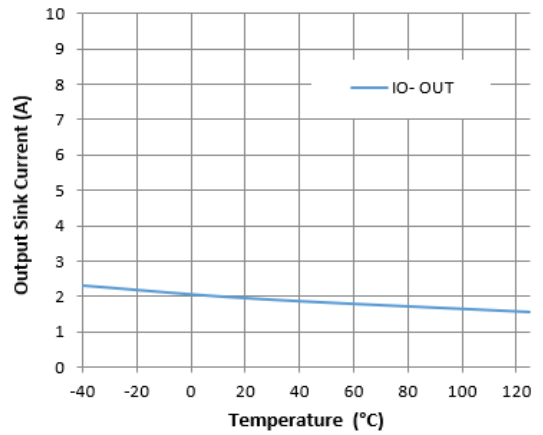

Figure 15. Output Sink Current vs. Temperature

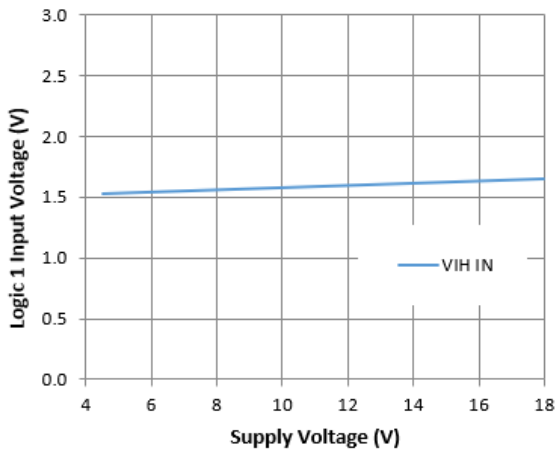

Figure 16. Logic 1 Input Voltage vs. Supply Voltage

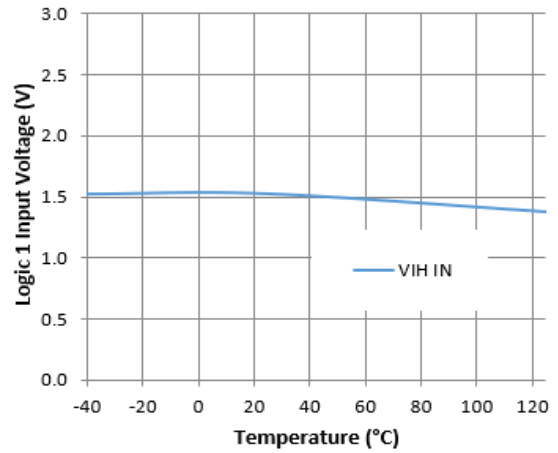

Figure 17. Logic 1 Input Voltage vs. Temperature

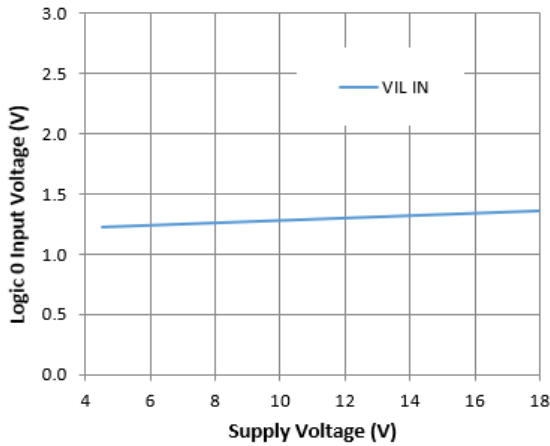

Figure 18. Logic 0 Input Voltage vs. Supply Voltage

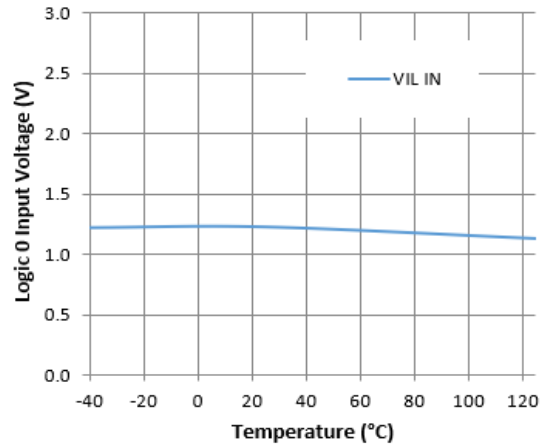
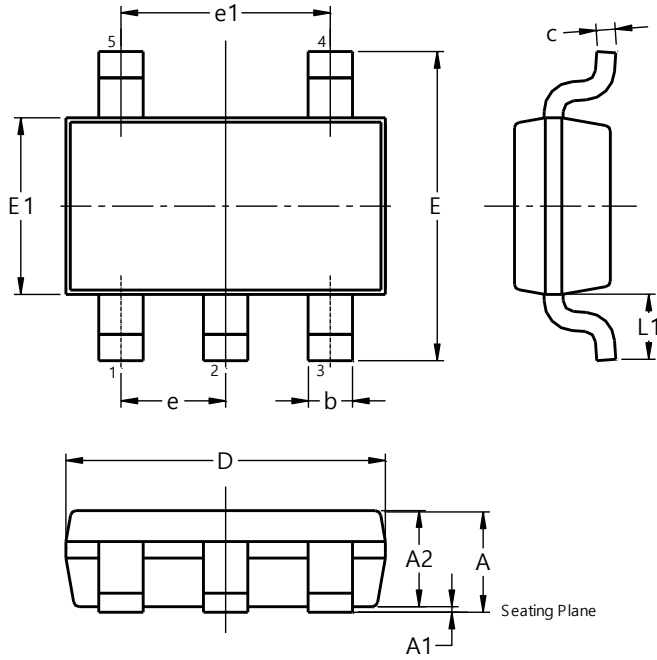

Figure 19. Logic 0 Input Voltage vs. Temperature

Package Outline Dimensions

Please see <http://www.diodes.com/package-outlines.html> for the latest version.

TSOT25 (Type TH)



TSOT25 (Type TH)			
Dim	Min	Max	Typ
A	--	1.10	--
A1	0.01	0.10	--
A2	0.70	1.00	0.90
b	0.30	0.50	--
c	0.08	0.20	--
D	2.90 BSC		
E	2.80 BSC		
E1	1.60 BSC		
e	0.95 BSC		
e1	1.90 BSC		
L1	0.60 REF		
All Dimensions in mm			

Suggested Pad Layout

Please see <http://www.diodes.com/package-outlines.html> for the latest version.

TSOT25 (Type TH)

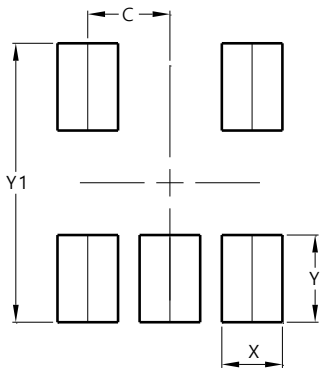

Dimensions	Value (in mm)
C	0.950
X	0.700
Y	1.000
Y1	3.199

IMPORTANT NOTICE

1. DIODES INCORPORATED AND ITS SUBSIDIARIES ("DIODES") MAKE NO WARRANTY OF ANY KIND, EXPRESS OR IMPLIED, WITH REGARDS TO ANY INFORMATION CONTAINED IN THIS DOCUMENT, INCLUDING, BUT NOT LIMITED TO, THE IMPLIED WARRANTIES OF MERCHANTABILITY, FITNESS FOR A PARTICULAR PURPOSE OR NON-INFRINGEMENT OF THIRD PARTY INTELLECTUAL PROPERTY RIGHTS (AND THEIR EQUIVALENTS UNDER THE LAWS OF ANY JURISDICTION).
2. The Information contained herein is for informational purpose only and is provided only to illustrate the operation of Diodes products described herein and application examples. Diodes does not assume any liability arising out of the application or use of this document or any product described herein. This document is intended for skilled and technically trained engineering customers and users who design with Diodes products. Diodes products may be used to facilitate safety-related applications; however, in all instances customers and users are responsible for (a) selecting the appropriate Diodes products for their applications, (b) evaluating the suitability of the Diodes products for their intended applications, (c) ensuring their applications, which incorporate Diodes products, comply the applicable legal and regulatory requirements as well as safety and functional-safety related standards, and (d) ensuring they design with appropriate safeguards (including testing, validation, quality control techniques, redundancy, malfunction prevention, and appropriate treatment for aging degradation) to minimize the risks associated with their applications.
3. Diodes assumes no liability for any application-related information, support, assistance or feedback that may be provided by Diodes from time to time. Any customer or user of this document or products described herein will assume all risks and liabilities associated with such use, and will hold Diodes and all companies whose products are represented herein or on Diodes' websites, harmless against all damages and liabilities.
4. Products described herein may be covered by one or more United States, international or foreign patents and pending patent applications. Product names and markings noted herein may also be covered by one or more United States, international or foreign trademarks and trademark applications. Diodes does not convey any license under any of its intellectual property rights or the rights of any third parties (including third parties whose products and services may be described in this document or on Diodes' website) under this document.
5. Diodes products are provided subject to Diodes' Standard Terms and Conditions of Sale (<https://www.diodes.com/about/company/terms-and-conditions/terms-and-conditions-of-sales/>) or other applicable terms. This document does not alter or expand the applicable warranties provided by Diodes. Diodes does not warrant or accept any liability whatsoever in respect of any products purchased through unauthorized sales channel.
6. Diodes products and technology may not be used for or incorporated into any products or systems whose manufacture, use or sale is prohibited under any applicable laws and regulations. Should customers or users use Diodes products in contravention of any applicable laws or regulations, or for any unintended or unauthorized application, customers and users will (a) be solely responsible for any damages, losses or penalties arising in connection therewith or as a result thereof, and (b) indemnify and hold Diodes and its representatives and agents harmless against any and all claims, damages, expenses, and attorney fees arising out of, directly or indirectly, any claim relating to any noncompliance with the applicable laws and regulations, as well as any unintended or unauthorized application.
7. While efforts have been made to ensure the information contained in this document is accurate, complete and current, it may contain technical inaccuracies, omissions and typographical errors. Diodes does not warrant that information contained in this document is error-free and Diodes is under no obligation to update or otherwise correct this information. Notwithstanding the foregoing, Diodes reserves the right to make modifications, enhancements, improvements, corrections or other changes without further notice to this document and any product described herein. This document is written in English but may be translated into multiple languages for reference. Only the English version of this document is the final and determinative format released by Diodes.
8. Any unauthorized copying, modification, distribution, transmission, display or other use of this document (or any portion hereof) is prohibited. Diodes assumes no responsibility for any losses incurred by the customers or users or any third parties arising from any such unauthorized use.

Copyright © 2021 Diodes Incorporated

www.diodes.com