

60583-2 ✓ ACTIVE

FASTON | FASTON 250

TE Internal #: 60583-2

Quick Disconnects, Receptacle, 12 – 10 AWG Wire Size, 3.31 – 5.26 mm² Wire Size, 9600 CMA Wire Size, Mating Tab Width 6.35 mm [.25 in], FASTON 250

[View on TE.com >](#)



Terminals & Splices > Quick Disconnects



Quick Disconnect Terminal Type: **Receptacle**

Wire Size: **9600 CMA**

Mating Tab Width: **6.35 mm [.25 in]**

Features

Product Type Features

Insertion Force	Normal
-----------------	--------

Configuration Features

Connection Capacity	Single
Compatible With Wire & Cable Type	Discrete Wire

Contact Features

Quick Disconnect Terminal Type	Receptacle
Mating Tab Width	6.35 mm[.25 in]
Mating Tab Thickness	.81 mm[.032 in]
Terminal Orientation	Flag
Contact Base Material	Brass
Terminal Plating Material	Tin
Crimp Type	Tab-Lok
Barrel Type	Open

Termination Features

Product Terminates To	Wire & Cable
-----------------------	--------------



Mechanical Attachment

Wire Insulation Support	With
Mating Retention Type	Dimple

Dimensions

Terminal Material Thickness	.46 mm[.018 in]
Compatible Insulation Diameter Range	2.79 – 5.33 mm[.11 – .21 in]
Wire Size	9600 CMA

Usage Conditions

Insulation Option	Uninsulated
Operating Temperature Range	-40 – 110 °C[-40 – 230 °F]

Packaging Features

Packaging Quantity	1000
Packaging Method	Loose Piece/Carton

Other

Terminals & Splices Comment	Hermetic Terminals
-----------------------------	--------------------

Product Compliance

[For compliance documentation, visit the product page on TE.com>](#)

EU RoHS Directive 2011/65/EU	Compliant
EU ELV Directive 2000/53/EC	Compliant
China RoHS 2 Directive MIIT Order No 32, 2016	No Restricted Materials Above Threshold
EU REACH Regulation (EC) No. 1907/2006	Current ECHA Candidate List: JUNE 2023 (235) Candidate List Declared Against: JAN 2023 (233) Does not contain REACH SVHC
Halogen Content	Low Halogen - Br, Cl, F, I < 900 ppm per homogenous material. Also BFR/CFR/PVC Free
Solder Process Capability	Not applicable for solder process capability

Product Compliance Disclaimer

This information is provided based on reasonable inquiry of our suppliers and represents our current actual knowledge based on the information they provided. This information is subject to change. The part numbers that TE has identified as EU RoHS compliant have a maximum concentration of 0.1% by weight in homogenous materials for lead, hexavalent chromium, mercury, PBB, PBDE, DBP, BBP, DEHP, DIBP, and 0.01% for cadmium, or qualify for an exemption to these limits as defined in the Annexes of Directive 2011/65/EU (RoHS2). Finished electrical and electronic equipment products will be CE marked as required by Directive 2011/65/EU. Components may not be CE marked. Additionally, the part

numbers that TE has identified as EU ELV compliant have a maximum concentration of 0.1% by weight in homogenous materials for lead, hexavalent chromium, and mercury, and 0.01% for cadmium, or qualify for an exemption to these limits as defined in the Annexes of Directive 2000/53/EC (ELV). Regarding the REACH Regulation, the information TE provides on SVHC in articles for this part number is based on the latest European Chemicals Agency (ECHA) 'Guidance on requirements for substances in articles' posted at this URL: <https://echa.europa.eu/guidance-documents/guidance-on-reach>

Compatible Parts



TE Part # 60851-3
250 FASTON REC 12-10 AWG TPBR



TE Part # 42232-3
250 FASTON FLAG REC 18-12 AWG TPBR



TE Part # 41898
250 FASTON FLAG REC 18-12 AWG TPBR



TE Part # 42015
250 FASTON FLAG REC 18-12 AWG TPBZ



TE Part # 60583-1
250 FASTON FLAG REC 12-10 AWG SPBZ

Also in the Series | FASTON 250



Compression Connectors(4)



Crimp Terminal Housings(142)



Insertion & Extraction Tools(6)



Magnet Wire Terminals(1)



PCB Terminals(135)



Quick Disconnects(445)



Splices(4)

Customers Also Bought



TE Part #2176071-5
3521 200K 1% 2W

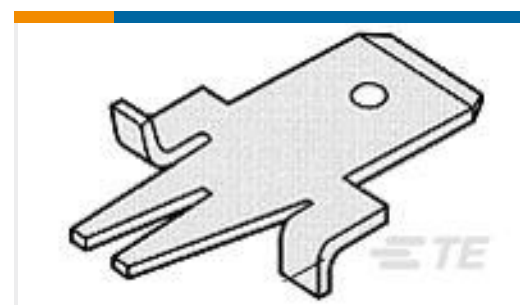

TE Part #63067-1
250 FASTON TAB TPBR

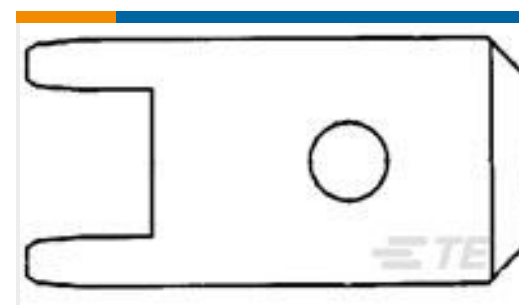

TE Part #170267-1
250 FASTON, PCB TAB, TCBR

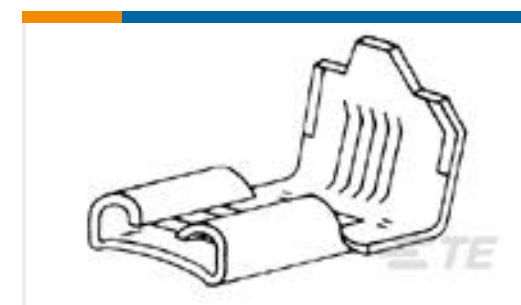

TE Part #62057-3
250 FASTON FLAG REC 12-10 AWG
TPBR

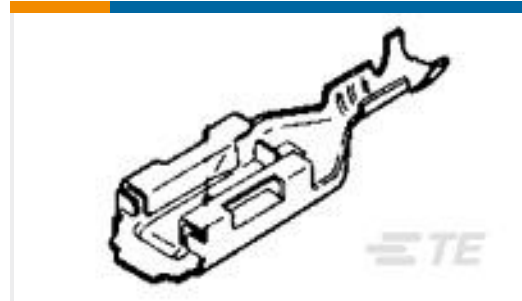

TE Part #170456-2
PL 250 AM REC 12-10 0.40 X 21 PRE-
TPBR



TE Part #170725-2
SOLIS RING



TE Part #1-2176397-1
3502 2R7 1%

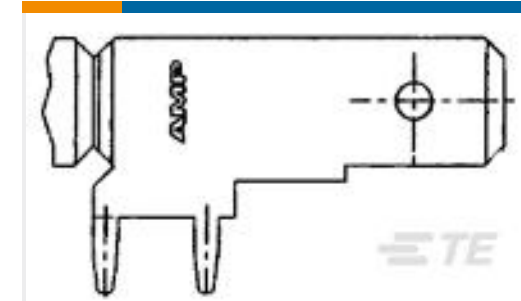

TE Part #1217754-1
250 FASTON, FLAG, PCB TAB, TNBR

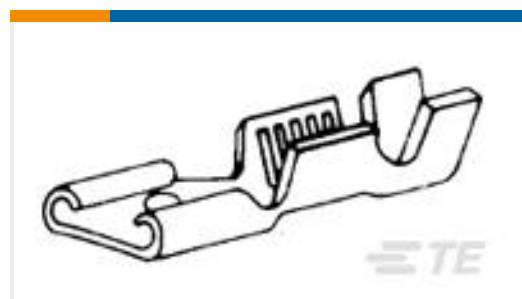

TE Part #60385-2
.250 FAST REC IS 18-2/17 TPBR



TE Part #63661-1
MAG-MATE POST 19-17 016TPCUBR

Documents

Product Drawings

[250 FASTON FLAG REC 12-10 AWG TPBR](#)

English

CAD Files

Customer View Model

[ENG_CVM_CVM_60583-2_H.2d_dxf.zip](#)

English

3D PDF

3D

Customer View Model

[ENG_CVM_CVM_60583-2_H.3d_igs.zip](#)

English

Customer View Model

[ENG_CVM_CVM_60583-2_H.3d_stp.zip](#)

English

By downloading the CAD file I accept and agree to the [Terms and Conditions](#) of use.

Product Specifications



Engineering Report

English

Agency Approvals

UL Report

English