



MAXADClite Evaluation Kit

General Description

The MAXADClite evaluation kit (EV kit) evaluates the MAX11645, Maxim's smallest, very-low-power, 12-bit, 2-channel analog-to-digital converter (ADC). The EV kit allows usage of the ADC's internal reference or an externally applied reference voltage.

The EV kit includes Windows XP®, Windows Vista®, and Windows® 7-compatible software for data acquisition through a USB cable.

EV Kit Contents

The EV kit comes with the following components:

- MAXADClite evaluation board
- MAXADClite GUI application

Features

- ◆ Windows XP-, Windows Vista-, and Windows 7-Compatible Software
- ◆ USB-PC Connection (Cable Not Included)
- ◆ USB Powered (No External Power Supply Required)
- ◆ Real-Time Data Acquisition Through the USB

Ordering Information

PART	TYPE
MAXADClite#	EV Kit

#Denotes RoHS compliant.

Component List

DESIGNATION	QTY	DESCRIPTION
C1, C2	2	18pF ±5%, 50V ceramic capacitors (0603)
C3, C5–C8	5	1µF ±10%, 16V ceramic capacitors (0603)
C4, C10, C11, C12	4	0.1µF ±10%, 50V ceramic capacitors (0603)
C9	1	10µF ±10%, 10V ceramic capacitor (0805)
D1	1	Green LED (0603)
D2	1	Yellow LED (0603)
J1	1	Mini-USB type-B receptacle
J2	0	Not installed, 10-pin JTAG connector
J3	1	4-pin header, 100 mill centers
J5–J8	0	Not installed
R1, R2	2	27Ω ±5% resistors (0603)

DESIGNATION	QTY	DESCRIPTION
R3, R4	2	4.7kΩ ±5% resistors (0603)
R5, R6	2	1kΩ ±5% resistors (0603)
R7, R8	2	499kΩ ±5% resistors (0603)
R9, R10	2	0Ω ±1% resistors (0603)
R11–R15	0	Not installed, resistors (0402)
U1	1	12-bit ADC with internal reference (12 WLP) Maxim MAX11645EWC+
U2	1	16-bit microcontroller (64 LQFP) Maxim MAXQ622G-0000+
U3	1	Ultra-low-noise, high-PSRR LDO linear regulator (5 SC70) Maxim MAX8511EXK33+
Y1	1	12MHz crystal
—	1	PCB: MAXADClite#

*EP = Exposed pad.

Windows, Windows XP, and Windows Vista are registered trademarks of Microsoft Corp.



Maxim Integrated Products 1

For pricing, delivery, and ordering information, please contact Maxim Direct at 1-888-629-4642, or visit Maxim's website at www.maxim-ic.com.

Evaluates: MAX11645

MAXADClite Evaluation Kit

Quick Start

The MAXADClite EV kit board is a plug-n-play data-acquisition kit that connects to the PC through a USB cable. The EV kit digitizes two different analog inputs and does not require an external power supply or a USB device driver. The EV kit is preloaded with default firmware that communicates with the MAXADClite evaluation software. Software can be installed and run on any Windows-based system.

Note: In the following sections, software-related items are identified by bolding. Text in **bold** refers to items directly from the EV kit software. Text in **bold and underlined** refers to items from the Windows operating system.

Procedure

The EV kit is fully assembled and tested. Follow the steps below to acquire data through the EV kit:

- 1) Connect the EV kit board to a PC through the USB cable. The EV kit board receives power from the USB.
- 2) Connect the analog input(s) at AIN0 or AIN1 and AGND at J3. See Table 1 for more details.
- 3) Install and run the MAXADClite GUI application.
- 4) Once the status bar displays **Hardware connected**, select correct board rev of MAXADClite.

- 5) In **Device Configuration** options, make selections of the following:
 - **Reference:** **Internal** (default) or **External**
 - **Channel:** **AIN0** (default) or **AIN1**
 - **Input Type:** **Single-Ended** (default) or **Differential**
 - **Input Polarity:** **Unipolar** (default) or **Bipolar**
- 6) Next, select the **Number of Samples** from the **Data Logging** group box drop-down list. Once all options are set, press the **Start Conversion** button to proceed (Figure 1).

Detailed Description of Hardware

The MAXADClite EV kit board is loaded with the MAX11645, Maxim's smallest, lowest power, 12-bit ADC. The ADC communicates through an I2C interface to the 16-bit RISC MAXQ622 microcontroller with integrated USB serial interface engine (SIE). This microcontroller can be configured as an HID device to communicate with the PC over USB (Figure 2).

The EV kit microcontroller is preloaded with firmware that communicates with the EV kit GUI application. Upon receiving the logging command from the GUI, it acquires data from the ADC over the I2C bus and sends it to the PC for display and further analysis.

Table 1. MAXADClite Connector J3 Description

J3 PIN NO.	LABEL	FUNCTION
1	AVDD	3.3V, 100mA supply for external circuit
2	AIN0	ADC input to channel 0
3	AIN1	ADC input to channel 1
4	AGND	Analog ground pin

MAXADClite Evaluation Kit

Evaluates: MAX11645

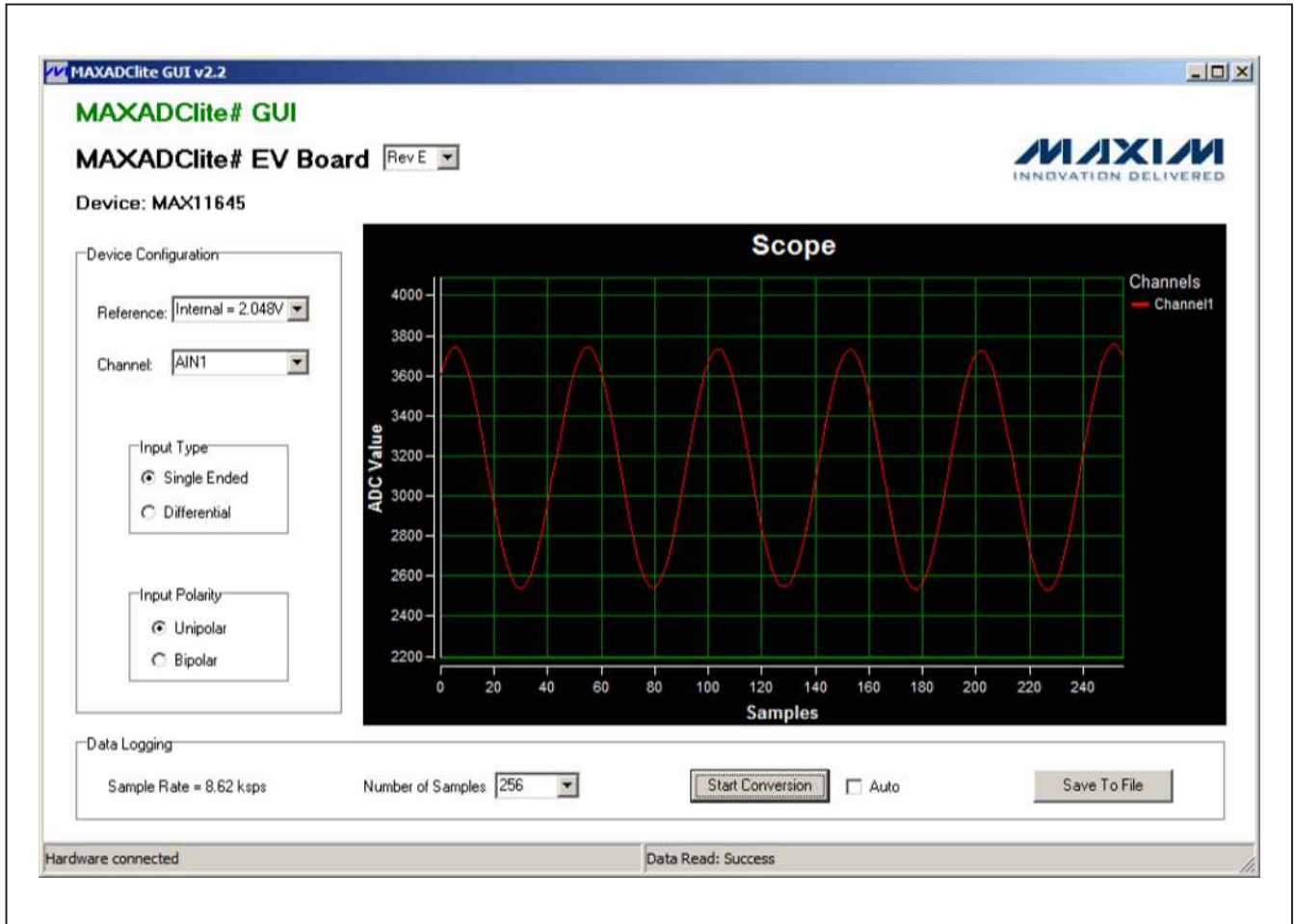

Figure 1. MAXADClite GUI Application

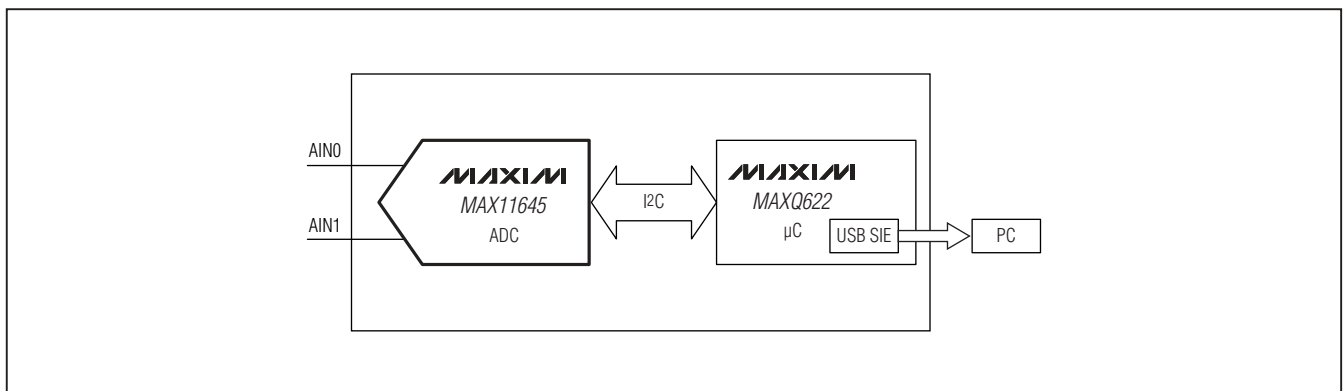

Figure 2. MAXADClite Block Diagram

MAXADClite Evaluation Kit

MAXADClite Extended Features

- The ADC on the EV kit board can be selected for internal or external reference mode. The internal 2.048V reference is the default configuration. The external reference mode can be selected through software. Apply an external voltage between 1V and VDD at J5 (see Table 2).
- The input range of the EV kit software is selectable between a unipolar 0 to VREF or $\pm VREF/2$ differential range. The input type is also software selectable between two single-ended inputs or one differential

input. The default input configuration is single-ended unipolar. In differential mode, the input needs to be connected on both the analog inputs (AIN0 and AIN1) on J3. Refer to the MAX11644/MAX11645 IC data sheet for more information.

- The EV kit board provides an external 5V supply at J6 to be used with any external circuit (see Table 3).
- The microcontroller on the EV kit board can also be programmed with custom firmware through the J2 JTAG connector (see Table 4).

Table 2. MAXADClite Connector J5 Description

J5 PIN NO.	LABEL	FUNCTION
1	VREF	External reference voltage input to the ADC
2	AGND	Analog ground pin

Table 3. MAXADClite Connector J6 Description

J6 PIN NO.	LABEL	FUNCTION
1	VUSB	5V, 300mA supply for the external circuit
2	GND	Digital ground pin

Table 4. MAXADClite Connector J2 Description

J2 PIN NO.	LABEL	FUNCTION
1	TCK	Test clock
2	GND	Digital ground pin
3	TDO	Test data output
4	+3V3	Supply voltage for reference only
5	TMS	Test mode select
6	RST	MAXQ610 microcontroller reset pin
7	N.C.	No connect
8	VUSB*	5V supply for the JTAG debug adapter
9	TDI	Test data input
10	GND	Digital ground pin

*Not directly connected to VUSB. Shunt J4 is for VUSB.

MAXADClite Evaluation Kit

Evaluates: MAX11645

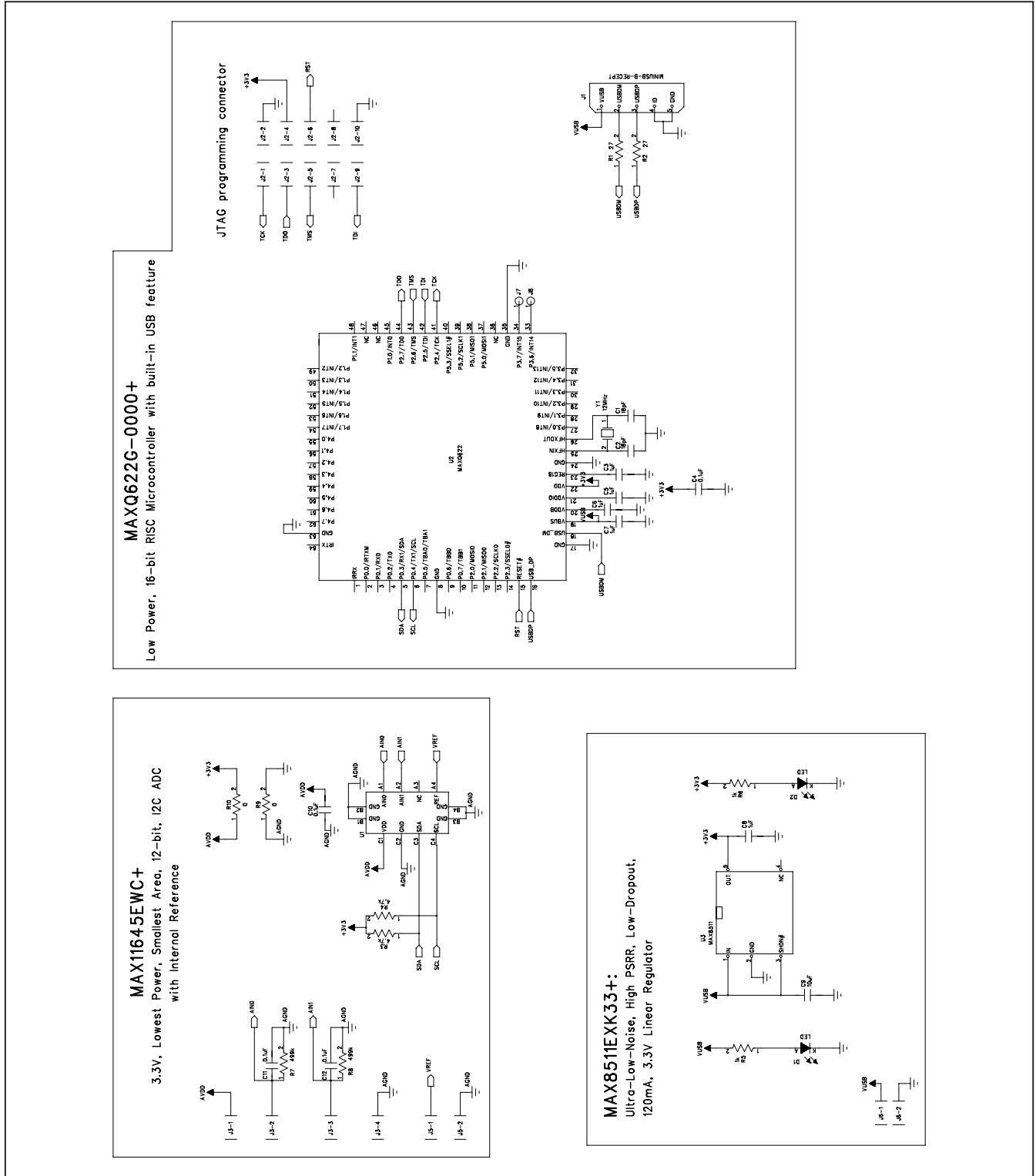

Figure 3. MAXADClite EV Kit Schematic

MAXADClite Evaluation Kit

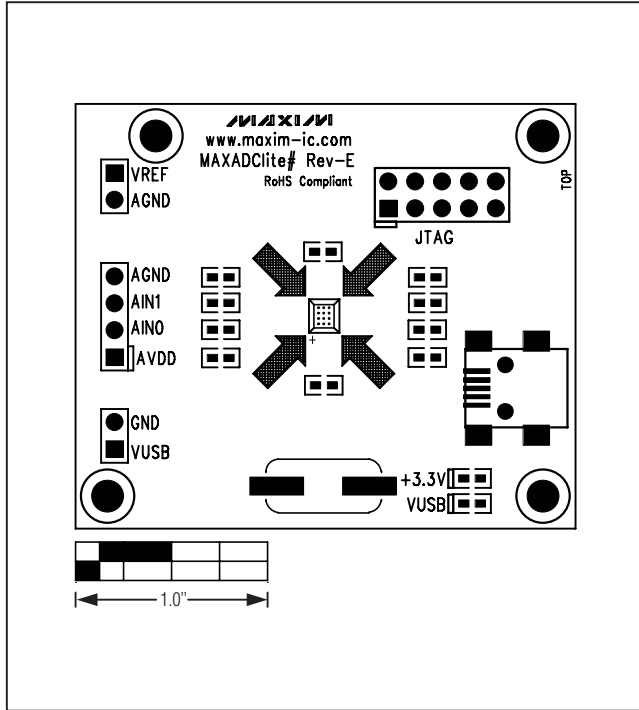

Figure 4. MAXADClite Component Placement Guide—Component Side

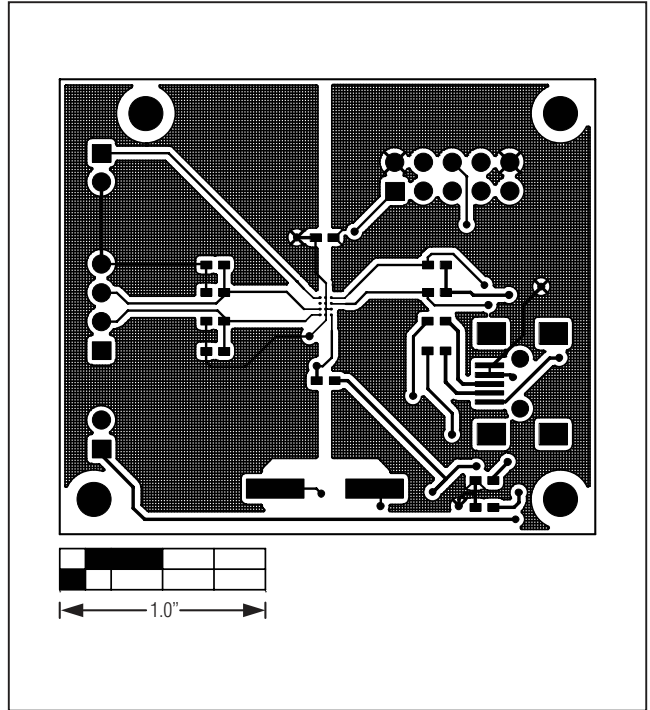

Figure 6. MAXADClite PCB Layout—Component Side

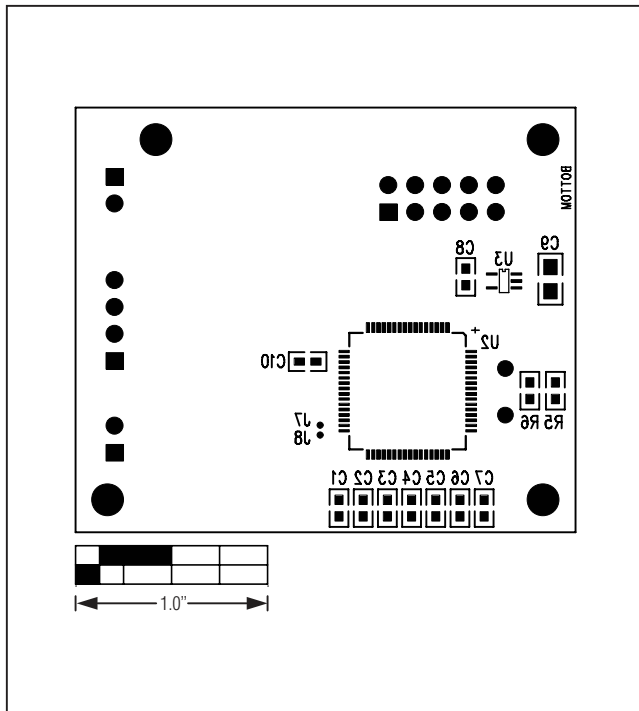

Figure 5. MAXADClite Component Placement Guide—Solder Side

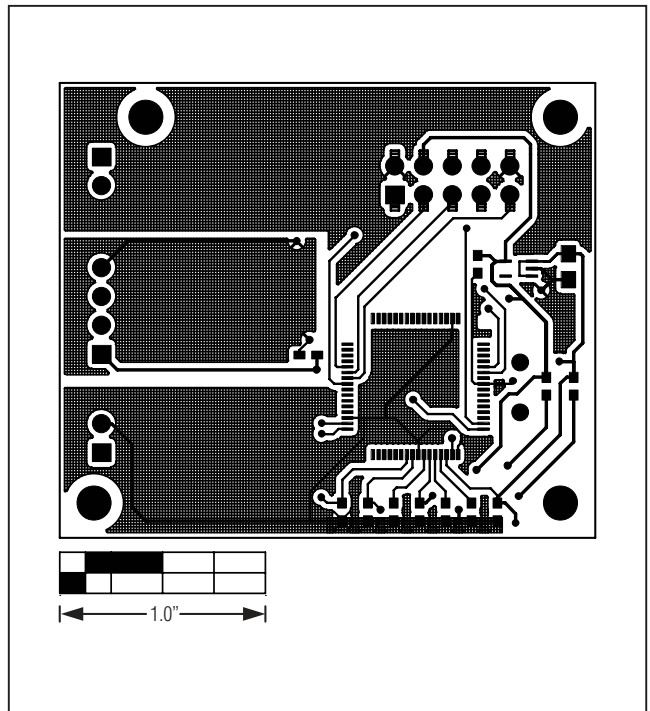

Figure 7. MAXADClite PCB Layout—Solder Side

MAXADClite Evaluation Kit

Revision History

REVISION NUMBER	REVISION DATE	DESCRIPTION	PAGES CHANGED
0	10/10	Initial release	—
1	8/11	Updated <i>Ordering Information</i> , <i>Component List</i> , and replaced PCB layout diagrams	1-5

Evaluates: MAX11645

Maxim cannot assume responsibility for use of any circuitry other than circuitry entirely embodied in a Maxim product. No circuit patent licenses are implied. Maxim reserves the right to change the circuitry and specifications without notice at any time.

Maxim Integrated Products, 120 San Gabriel Drive, Sunnyvale, CA 94086 408-737-7600 _____ 7