

THIS DRAWING IS UNPUBLISHED. RELEASED FOR PUBLICATION 20
 © COPYRIGHT 20 BY TYCO ELECTRONICS CORPORATION. ALL RIGHTS RESERVED.

LOC	DIST	REVISIONS			
P	LTR	DESCRIPTION	DATE	DWN	APVD
F	00	B	ECR 07-025006	29OCT2007	JT GR

COUPE C-C

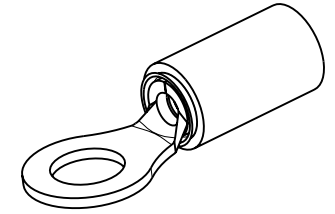
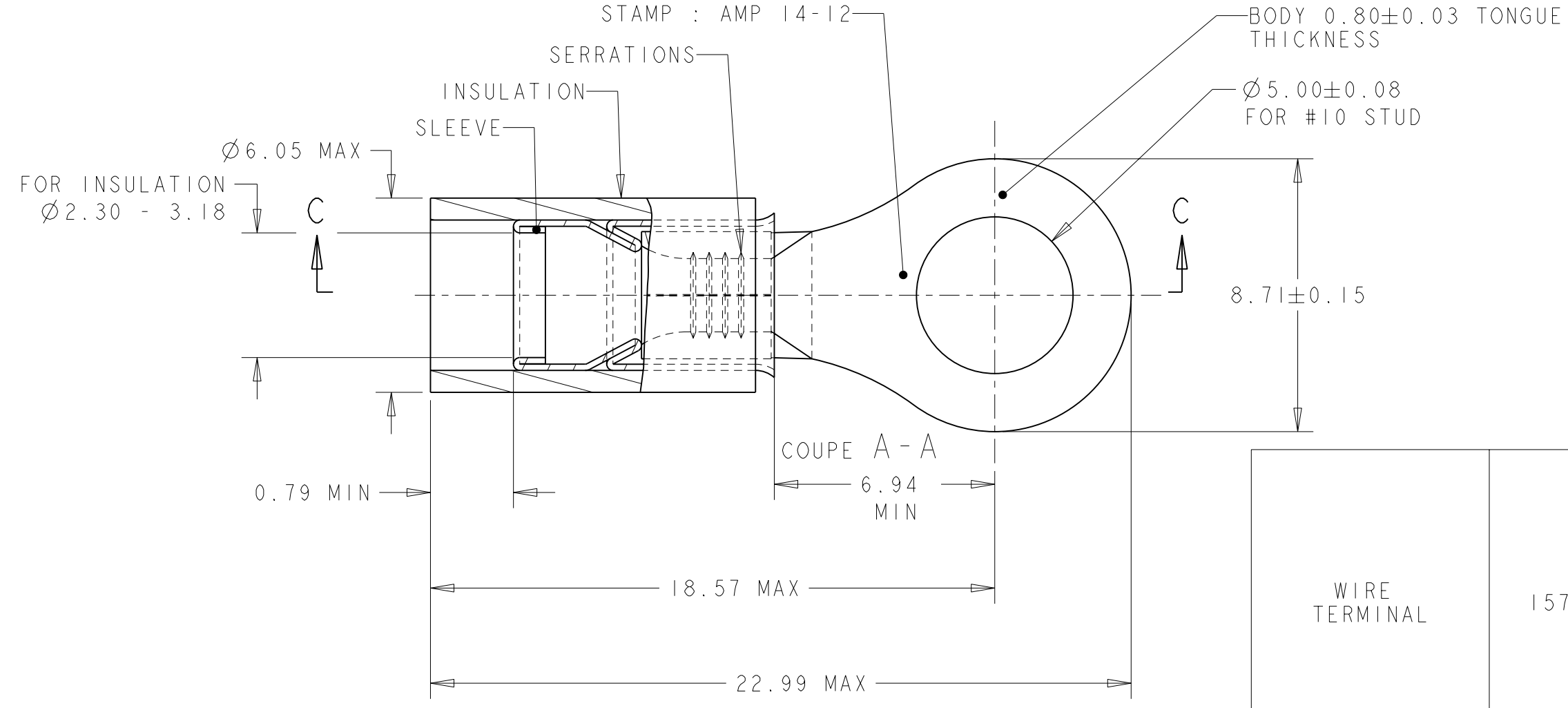
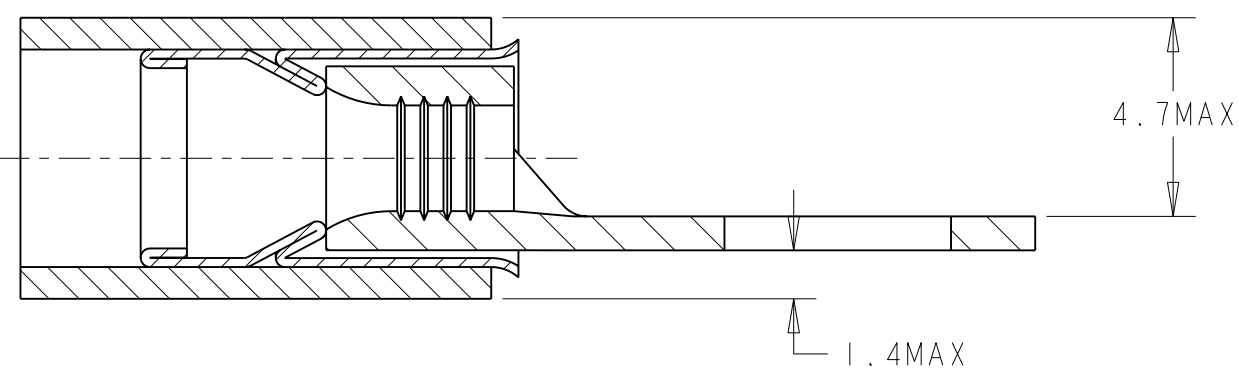

SCALE 2:1

WIRE TERMINAL	1577640-1	BODY : COPPER ANNEALED FINISH : NICKEL PLATED
		SLEEVE : COPPER ANNEALED FINISH : NICKEL PLATED
		INSULATION : PEEK COLOR : BEIGE
DESCRIPTION	PART NUMBER	MATERIAL & FINISH

<small>THIS DRAWING IS A CONTROLLED DOCUMENT FOR TYCO ELECTRONICS CORPORATION IT IS SUBJECT TO CHANGE AND THE CONTROLLING ENGINEERING ORGANIZATION SHOULD BE CONTACTED FOR THE LATEST REVISION.</small>		DWN	22FEB2006	 Tyco Electronics France SAS 95300 Pontoise, France
DIMENSIONS: mm		CHK	22FEB2006	
TOLERANCES UNLESS OTHERWISE SPECIFIED:		APVD	22FEB2006	
0 PLC ±- 1 PLC ±0.3 2 PLC ±- 3 PLC ±- 4 PLC ±- ANGLES ±5 FINISH SEE TABLE		NAME	Y. PETRONIN	
MATERIAL SEE TABLE		PRODUCT SPEC	108-15356	TERMINAL, PEEK PIDG STRATO, 14-12 AWG
		APPLICATION SPEC	114-15102	SIZE CAGE CODE DRAWING NO RESTRICTED TO A3 00779 C-1577640
		WEIGHT	1,17 gr	SCALE 6:1 SHEET 1 OF 1 REV B
		CUSTOMER DRAWING		