

FAN5091

Two Slice Interleaved Synchronous Buck Converter

Features

- Programmable output from 1.10V to 1.85V in 25mV steps using an integrated 5-bit DAC
- Two interleaved synchronous slices for maximum performance
- 100nsec response time
- Built-in current sharing between slices
- Remote sense
- Programmable Active Droop™ (Voltage Positioning)
- Programmable frequency from 200KHz to 2MHz
- Adaptive delay gate switching
- Integrated high-current gate drivers
- Integrated Power Good, OV, UV, Enable/Soft Start functions
- Drives N-channel MOSFETs
- Operation optimized for 5V operation
- High efficiency mode (E*) at light load
- Overcurrent protection using MOSFET sensing
- 24 pin TSSOP package

Applications

- Power supply for Pentium® IV
- Power supply for Athlon®
- VRM for Pentium IV processor
- Programmable step-down power supply

Description

The FAN5091 is a synchronous multi-slice DC-DC controller IC which provides a highly accurate, programmable output voltage for all high-performance processors. Two interleaved synchronous buck regulator slices with built-in current sharing operate 180° out of phase to provide the fast transient response needed to satisfy high current applications while minimizing external components. The FAN5091 features remote voltage sensing and Programmable Active Droop™ for 100nsec converter transient response with minimum output capacitance. It has integrated high-current gate drivers, with adaptive delay gate switching, eliminating the need for external drive devices. The FAN5091 uses a 5-bit D/A converter to program the output voltage from 1.10V to 1.85V in 25mV steps with an accuracy of 1%. The FAN5091 uses a high level of integration to deliver load currents in excess of 50A from a 5V source with minimal external circuitry. The FAN5091 also offers integrated functions including Power Good, Output Enable/Soft Start, under-voltage lockout, over-voltage protection, and adjustable current limiting with independent current sense on each slice. It is available in a 24 pin TSSOP package.

Block Diagram

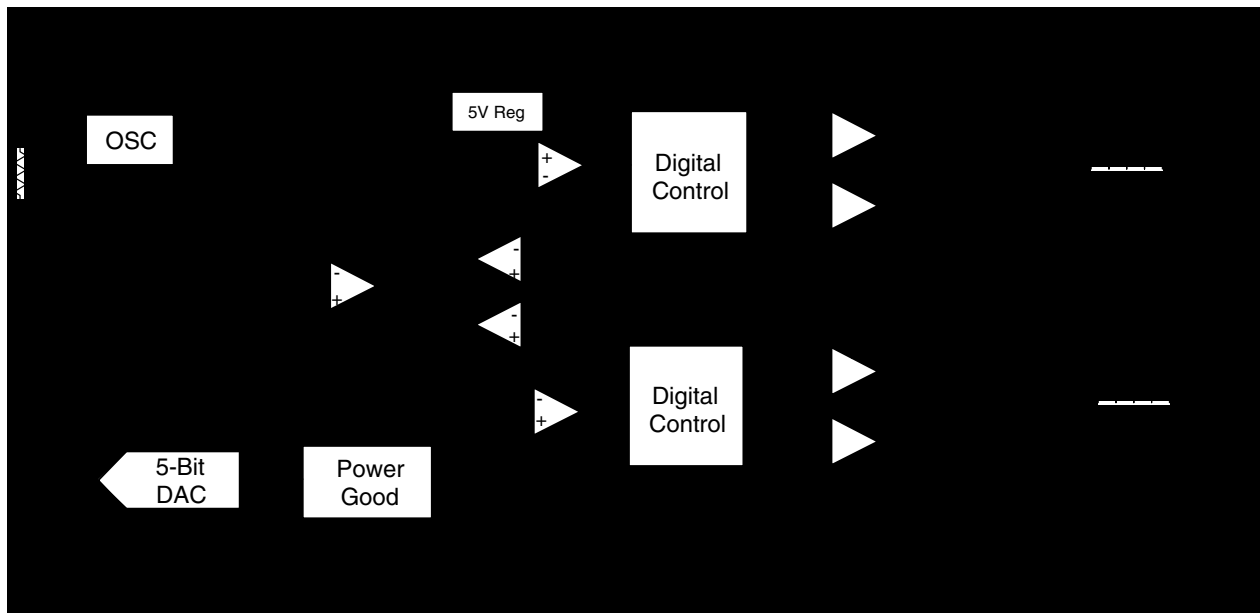

Pin Assignments

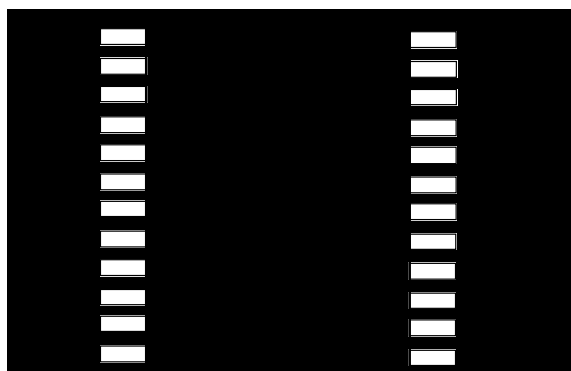

Pin Definitions

Pin Number	Pin Name	Pin Function Description
1-5	VID0-4	Voltage Identification Code Inputs. These open collector/TTL compatible inputs will program the output voltage over the ranges specified in Table 1. Pull-ups are internal to the controller.
6	BYPASS	5V Rail. Bypass this pin with a 1 μ F ceramic capacitor to AGND.
7	AGND	Analog Ground. Return path for low power analog circuitry. This pin should be connected to a low impedance system ground plane to minimize ground loops.
8	LDRVB	Low Side FET Driver for B. Connect this pin to the gate of an N-channel MOSFET for synchronous operation. The trace from this pin to the MOSFET gate should be <0.5".
9	PGNDB	Power Ground B. Return pin for high currents flowing in low-side MOSFET. Connect directly to low-side MOSFET source.
10	SWB	High side driver source and low side driver drain switching node B. Gate drive return for high side MOSFET, and negative input for low-side MOSFET current sense.
11	HDRVB	High Side FET Driver B. Connect this pin to the gate of an N-channel MOSFET. The trace from this pin to the MOSFET gate should be <0.5".
12	BOOTB	Bootstrap B. Input supply for high-side MOSFET.
13	BOOTA	Bootstrap A. Input supply for high-side MOSFET.
14	HDRVA	High Side FET Driver A. Connect this pin to the gate of an N-channel MOSFET. The trace from this pin to the MOSFET gate should be <0.5".
15	SWA	High side driver source and low side driver drain switching node A. Gate drive return for high side MOSFET, and negative input for low-side MOSFET current sense.
16	PGNDA	Power Ground A. Return pin for high currents flowing in low-side MOSFET. Connect directly to low-side MOSFET source.
17	LDRVA	Low Side FET Driver for A. Connect this pin to the gate of an N-channel MOSFET for synchronous operation. The trace from this pin to the MOSFET gate should be <0.5".
18	VCC	VCC. Internal IC supply. Connect to system 12V supply, and decouple with a 0.1 μ F ceramic capacitor.
19	PWRGD	Power Good Flag. An open collector output that will be logic LOW if the output voltage is not within +10/-15% of the nominal output voltage setpoint.

Pin Number	Pin Name	Pin Function Description
20	ILIM	Current Limit. A resistor from this pin to ground sets the over current trip level.
21	DROOP/E*	Droop Control/Energy Star Mode Control. A resistor from this pin to ground sets the amount of droop by controlling the gain of the current sense amplifier. When this pin is pulled high to BYPASS, the slice A drivers are turned off for Energy-star operation.
22	ENABLE/SS	Output Enable/Softstart. A logic LOW on this pin will disable the output. An internal current source allows for open collector control. This pin also doubles as soft start.
23	RT	Frequency Set. A resistor from this pin to ground sets the switching frequency.
24	VFB	Voltage Feedback. Connect to the desired regulation point at the output of the converter.

Absolute Maximum Ratings

Parameter	Min.	Typ.	Max.	Unit
Supply Voltage VCC			15	V
Supply Voltages BOOTA, BOOTB			18	V
Voltage Identification Code Inputs, VID0-VID4			6	V
VFB, ENABLE/SS, PWRGD, DROOP/E*			6	V
SWA, SWB	-3		15	V
PGNDA, PGND B to AGND	-0.5		0.5	V
Gate Drive Current, peak pulse		3		A
Junction Temperature, T _J	-55		150	°C
Storage Temperature	-65		150	°C
Lead Soldering Temperature, 10 seconds		300		°C
Power Dissipation, P _D		950		mW
Thermal Resistance Junction-to-Case, θ_{JC}		13		°C/W

Recommended Operating Conditions

Parameter	Conditions	Min.	Typ.	Max.	Units
Output Driver Supply, BOOT		10.8	12	13.2	V
Input Logic HIGH		2.4			V
Input Logic LOW				0.8	V
Ambient Operating Temperature		0		70	°C

Electrical Specifications

($V_{CC} = 12V$, $V_{OUT} = 1.500V$, and $T_A = +25^\circ C$ using circuit in Figure 1, unless otherwise noted.)

The • denotes specifications which apply over the full operating temperature range.

Parameter	Conditions		Min.	Typ.	Max.	Units
Output Voltage	See Table 1	•	1.100		1.850	V
Output Current				50		A
Initial Voltage Setpoint	$I_{LOAD} = 5A$		1.485	1.500	1.515	V
Output Temperature Drift	$T_A = 0$ to $70^\circ C$			+5		mV
Line Regulation	$V_{CC} = 11.4V$ to $12.6V$	•		+130		μV
Droop ³	$I_{LOAD} = 0.8A$ to I_{max}		-90	-100	-110	mV
Programmable Droop Range			-10		0	% V_{out}
Total Output Variation, Steady State ¹	$I_{LOAD} = 0.8A$ to I_{max}	•	1.430		1.570	V
Total Output Variation, Transient ²	$I_{LOAD} = 0.8A$ to I_{max}	•	1.430		1.570	V
Response Time	$\Delta V_{out} = 10mV$			100		nsec
Gate Drive On-Resistance				1.0		Ω
Upper Drive Low Voltage	$V_{HDRV} - V_{SW}$ at $I_{sink} = 10\mu A$			0.2		V
Upper Drive High Voltage	$V_{BOOT} - V_{HDRV}$ at $I_{source} = 10\mu A$			0.5		V
Lower Drive Low Voltage	$I_{sink} = 10\mu A$			0.2		V
Lower Drive High Voltage	$V_{CC} - V_{LDRV}$ at $I_{source} = 10\mu A$			0.5		V
Output Driver Rise & Fall Time	See Figure 3			20		nsec
Current Mismatch	$R_{DS,on}(A) = R_{DS,on}(B)$, $I_{LOAD} = I_{max}$			5		%
Output Overvoltage Detect		•	2.1		2.3	V
Efficiency	$I_{LOAD} = I_{max}$ $I_{LOAD} = 2A$ (E*-mode)			85 70		%
Oscillator Frequency	$R_T = 41.2K\Omega$	•	450	600	750	KHz
Oscillator Range	$R_T = 125K\Omega$ to $12.5K\Omega$		200		2000	KHz
Maximum Duty Cycle	$R_T = 125K\Omega$			90		%
Minimum LDRV on-time	$R_T = 12.5K\Omega$			330		nsec
Input LOW current, VID pins	$V_{VID} = 0.4V$				50	μA
Soft Start Current				10		μA
Enable Threshold	ON OFF		0.4		1.0	V
BYPASS Voltage			4.75	5	5.25	V
BYPASS Capacitor			100			nF
PWRGD Threshold	Logic LOW, minimum Logic LOW, maximum	• •	81 106	85 110	89 114	% V_{out}
PWRGD Hysteresis				20		mV
PWRGD Output Voltage	$I_{sink} = 4mA$				0.4	V
PWRGD Delay	High \rightarrow Low			500		μsec
12V UVLO		•	8.5	9.5	10.5	V
UVLO Hysteresis				0.5		V
12V Supply Current	HDRV and LDRV Open			20		mA
Over Temperature Shutdown				150		$^\circ C$
Over Temperature Hysteresis				40		$^\circ C$

Notes:

1. Steady State Voltage Regulation includes Initial Voltage Setpoint, Output Ripple and Output Temperature Drift and is measured at the converter's VFB sense point.
2. As measured at the converter's VFB sense point. For motherboard applications, the PCB layout should exhibit no more than 0.5mΩ trace resistance between the converter's output capacitors and the CPU. Remote sensing should be used for optimal performance.
3. Using the VFB pin for remote sensing of the converter's output at the load, the converter will be in compliance with Intel's VRM 9.0 specification of +70, -70mV.

Table 1. Output Voltage Programming Codes

VID4	VID3	VID2	VID1	VID0	V _{OUT} to CPU
1	1	1	1	1	OFF
1	1	1	1	0	1.100V
1	1	1	0	1	1.125V
1	1	1	0	0	1.150V
1	1	0	1	1	1.175V
1	1	0	1	0	1.200V
1	1	0	0	1	1.225V
1	1	0	0	0	1.250V
1	0	1	1	1	1.275V
1	0	1	1	0	1.300V
1	0	1	0	1	1.325V
1	0	1	0	0	1.350V
1	0	0	1	1	1.375V
1	0	0	1	0	1.400V
1	0	0	0	1	1.425V
1	0	0	0	0	1.450V
0	1	1	1	1	1.475V
0	1	1	1	0	1.500V
0	1	1	0	1	1.525V
0	1	1	0	0	1.550V
0	1	0	1	1	1.575V
0	1	0	1	0	1.600V
0	1	0	0	1	1.625V
0	1	0	0	0	1.650V
0	0	1	1	1	1.675V
0	0	1	1	0	1.700V
0	0	1	0	1	1.725V
0	0	1	0	0	1.750V
0	0	0	1	1	1.775V
0	0	0	1	0	1.800V
0	0	0	0	1	1.825V
0	0	0	0	0	1.850V

Note:

1. 0 = VID pin is tied to GND.
1 = VID pin is open.

Typical Operating Characteristics

($V_{CC} = 12V$, and $T_A = +25^{\circ}C$ using circuit in Figure 2, unless otherwise noted.)

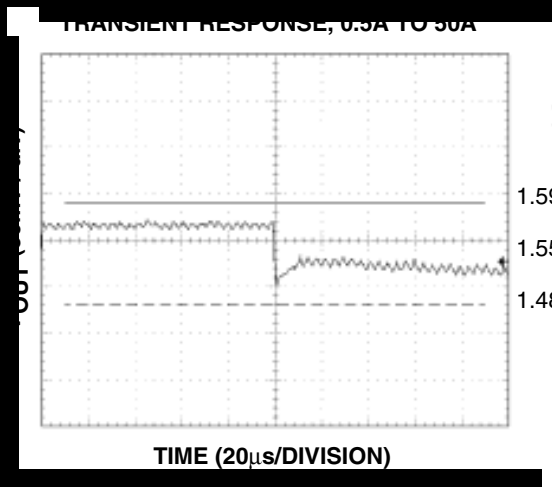
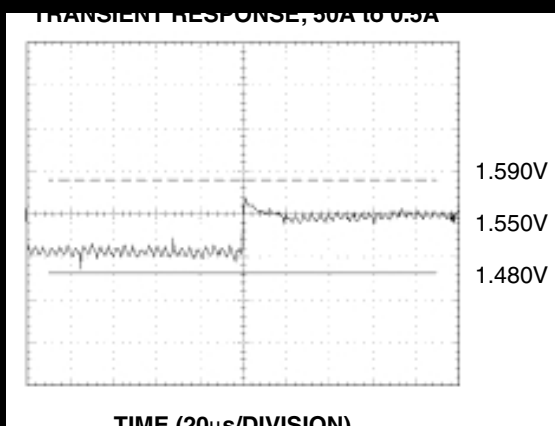

Typical Operating Characteristics (Continued)

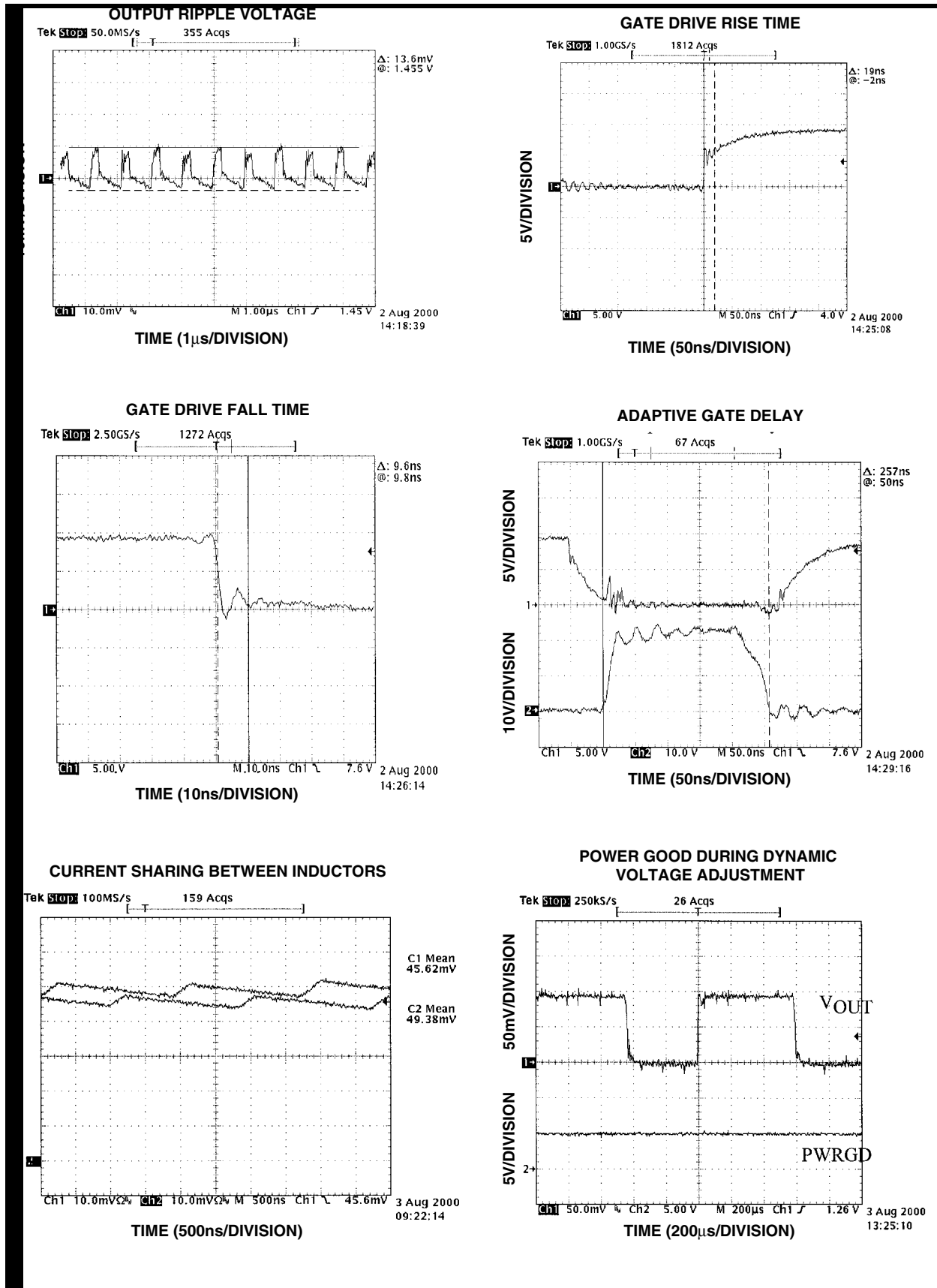

Typical Operating Characteristics (Continued)

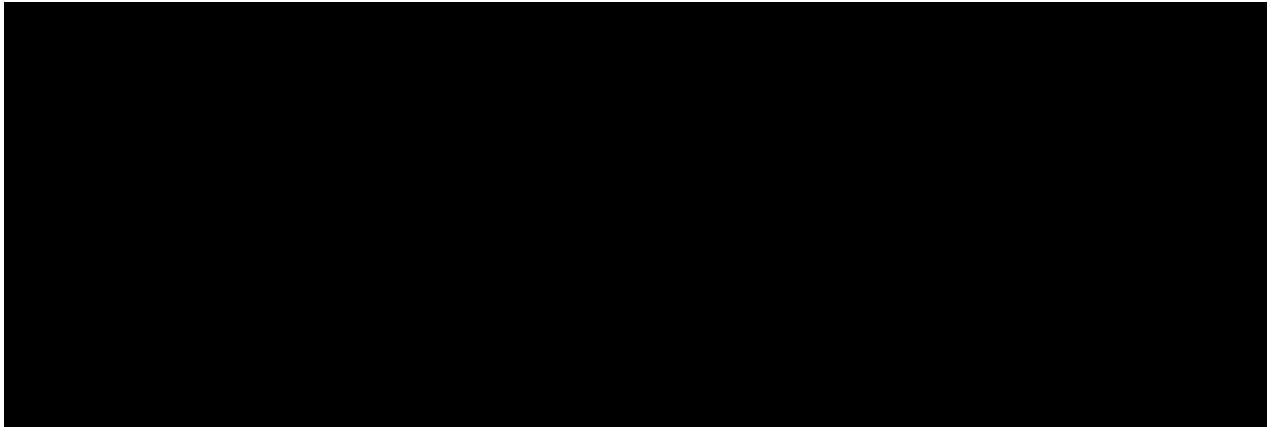

Application Circuit

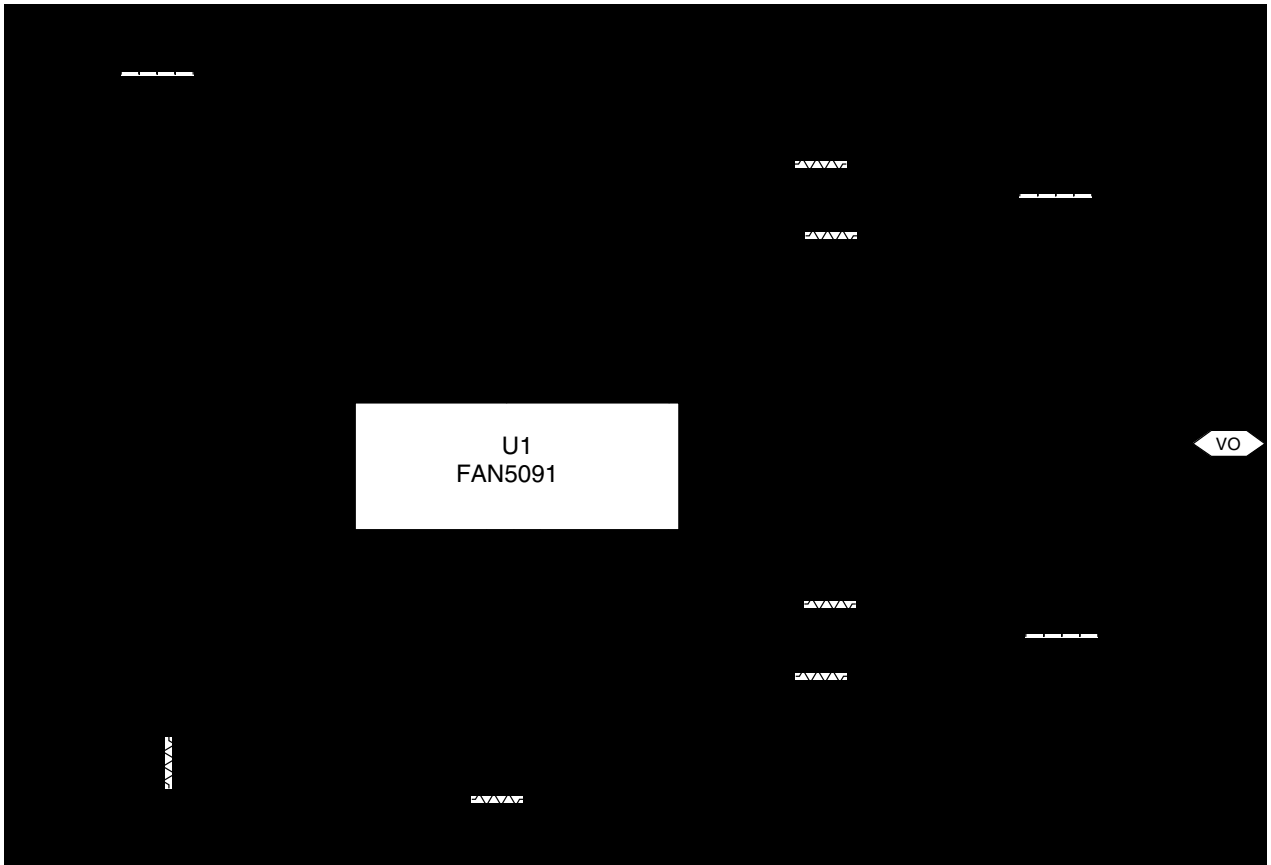

Figure 1. Application Circuit for 1.6V, 35A Athlon Medium-Frequency Application (500 KHz each slice)

Table 2. FAN5091 Application Bill of Materials for Figure 1

Reference	Manufacturer Part #	Quantity	Description	Requirements/Comments
C1-3	Panasonic ECU-V1H104ZFX	3	100nF, 50V Capacitor	
C _{IN}	Rubycon 16ZL1000M	3	1000μF, 16V Electrolytic	I _{RMS} = 3.8A @ 65°C
C _{OUT}	Rubycon 6.3ZL1500M	6	1500μF, 6.3V Electrolytic	ESR ≤ 23mΩ
D1-2	Motorola MBRD835L	2	8A, 35V Schottky Diode	
L1	Any	Optional	1.3μH, 14A Inductor	DCR ~ 4mΩ See Note 1.
L2-3	Any	2	500nH, 20A Inductor	DCR ~ 1.5mΩ
Q1, Q3	Fairchild FDB7030B	2	N-Channel MOSFET	R _{DS(ON)} = 9mΩ @ V _{GS} = 4.5V See Note 2.
Q2, Q4	Fairchild FDB7045L	2	N-Channel MOSFET	R _{DS(ON)} = 4.5mΩ @ V _{GS} = 4.5V See Note 2.
R1	Any	1	10KΩ	
R2	Any	1	62KΩ	
R3	Any	1	2.0KΩ	
R4	Any	1	24.9KΩ	
R5	Any	1	10Ω	
R6-7, R9-10	Any	4	4.7Ω	
U1	Fairchild FAN5091M	1	DC/DC Controller	

Notes:

1. Inductor L1 is recommended to isolate the 5V input supply from noise generated by the MOSFET switching, and to comply with Intel di/dt requirements. L1 may be omitted if desired.
2. For designs using the TO-220 MOSFETs, heatsinks with thermal resistance $\theta_{SA} < 20^{\circ}\text{C/W}$ should be used. For details and a spreadsheet on MOSFET selections, refer to Applications Bulletin AB-8.

*Output capacitance requirements depend critically on layout and processor type. Consult Application Bulletin AB-14 for details. See the Appendix to this datasheet for the method of calculation of these components. Pin 5 must be used to remote sense the voltage at the processor to achieve the specified performance.

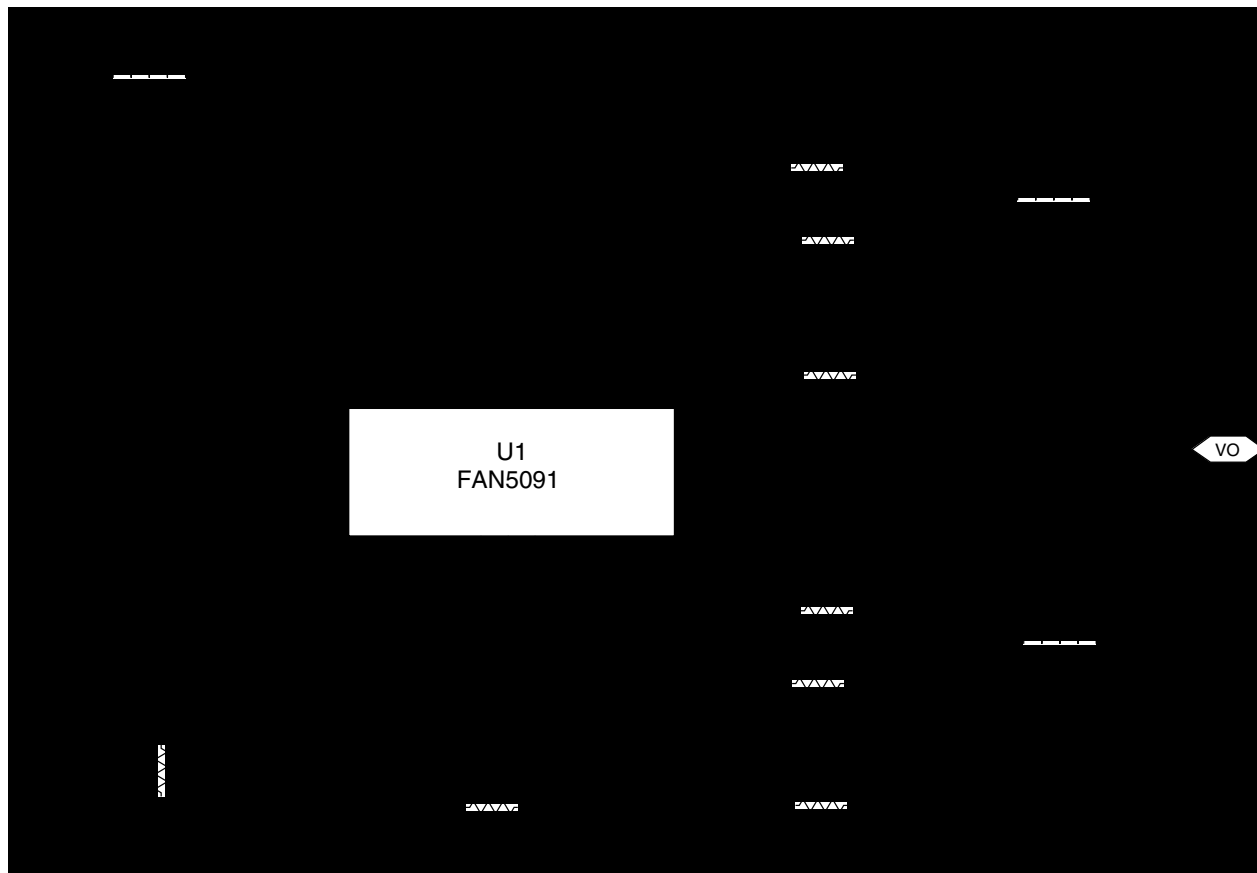

Figure 2. Application Circuit for 69A Willamette Low-Frequency Application (200KHz each slice)

Table 3. FAN5091 Application Bill of Materials for Figure 2

Reference	Manufacturer Part #	Quantity	Description	Requirements/Comments
C1-3	Panasonic ECU-V1H104ZFX	3	100nF, 50V Capacitor	
C _{IN}	Rubycon 16ZL1000M	5	1000μF, 16V Electrolytic	I _{RMS} = 3.8A @ 65°C
C _{OUT}	Rubycon 6.3ZL1500M	8	1500μF, 6.3V Electrolytic	ESR ≤ 23mΩ
D1-2	Motorola MBRB154SCT	2	15A, 45V Schottky Diode	
L1	Any	Optional	1.3μH, 25A Inductor	DCR ~ 1mΩ See Note 1.
L2-3	Coiltronics HC2-1R0	2	1μH, 33A Inductor	DCR ~ 600μΩ
Q1, Q4	Fairchild FDB7030BL	2	N-Channel MOSFET	R _{DS(ON)} = 9mΩ. See Note 2.
Q2-3, Q5-6	Fairchild FDB7045L	4	N-Channel MOSFET	R _{DS(ON)} = 4.5mΩ. See Note 2.
R1	Any	1	10KΩ	
R2	Any	1	150KΩ	
R3	Any	1	2.0KΩ	
R4	Any	1	61.9KΩ	
R5	Any	1	10Ω	
R6-11	Any	6	4.7Ω	
U1	Fairchild FAN5091M	1	DC/DC Controller	

Notes:

1. Inductor L1 is recommended to isolate the 5V input supply from noise generated by the MOSFET switching. L1 may be omitted if desired.
2. For a spreadsheet on MOSFET selections, refer to Applications Bulletin AB-8.

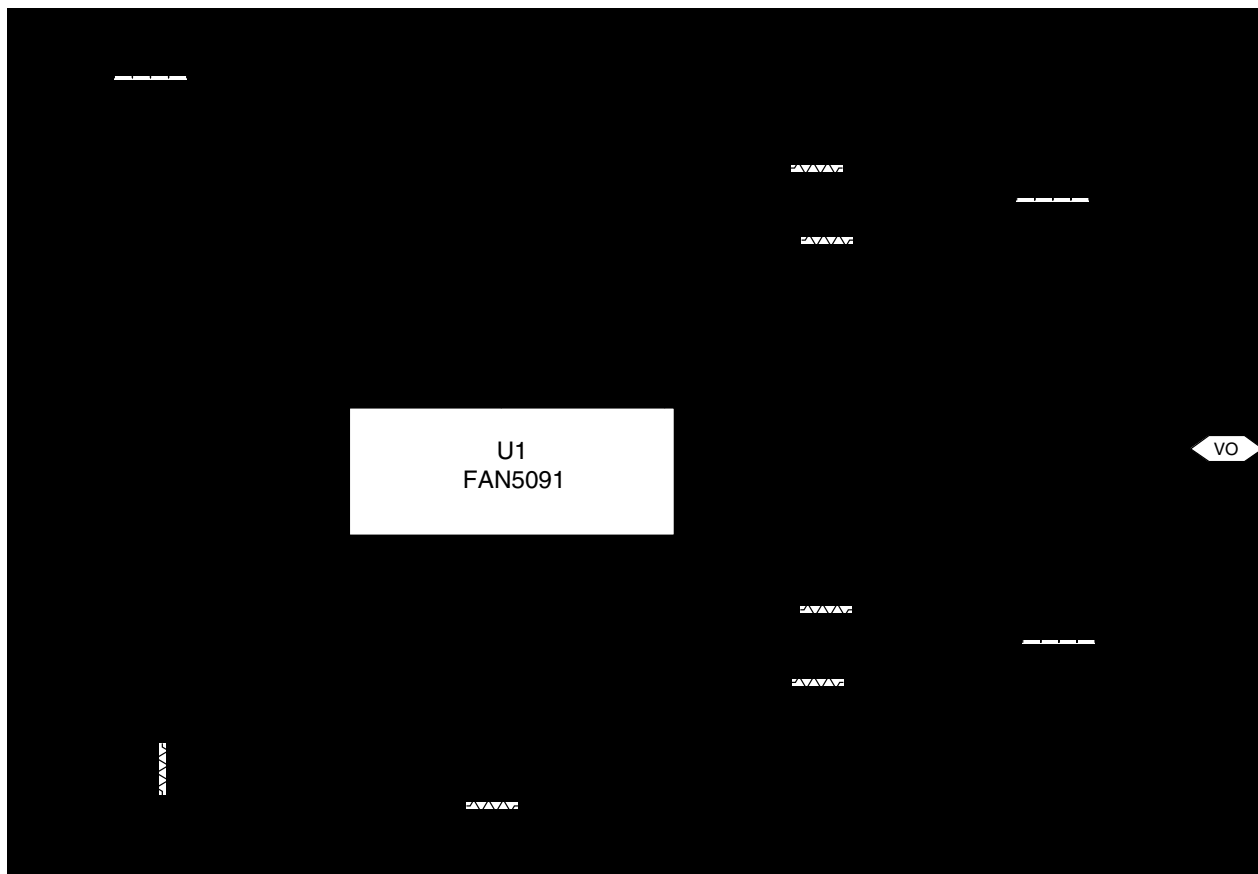

Figure 3. Application Circuit for 35A High-Frequency Application (1MHz each slice)

Table 4. FAN5091 Application Bill of Materials for Figure 3

Reference	Manufacturer Part #	Quantity	Description	Requirements/Comments
C1-3	Panasonic ECU-V1H104ZFX	3	100nF, 50V Capacitor	
C _{IN}	Rubycon 16ZL1000M	3	1000μF, 16V Electrolytic	I _{RMS} = 3.8A @ 65°C
C _{OUT}	Rubycon 6.3ZL1500M	6	1500μF, 6.3V Electrolytic	ESR ≤ 23mΩ
D1-2	Motorola MBRD835L	2	16A, 35V Schottky Diode	
L1	Any	Optional	1.3μH, 14A Inductor	DCR ~ 4mΩ See Note 1.
L2-3	Any	2	250nH, 20A Inductor	DCR ~ 1.5mΩ
Q1-4	Fairchild FDB6690A	4	N-Channel MOSFET	R _{DS(ON)} = 16mΩ, Q _G = 17nC. See Note 2.
R1	Any	1	10KΩ	
R2	Any	1	43.2KΩ	
R3	Any	1	82.5KΩ	
R4	Any	1	11KΩ	
R5	Any	1	10Ω	
R6-7, R9-10	Any	4	4.7Ω	
U1	Fairchild FAN5091M	1	DC/DC Controller	

Notes:

1. Inductor L1 is recommended to isolate the 5V input supply from noise generated by the MOSFET switching. L1 may be omitted if desired.
2. For a spreadsheet on MOSFET selections, refer to Applications Bulletin AB-8.

Test Parameters

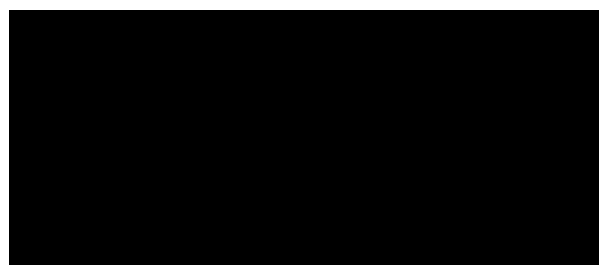

Figure 4. Output Drive Timing Diagram

Application Information

Operation

The FAN5091 Controller

The FAN5091 is a programmable synchronous multi-slice DC-DC controller IC. When designed around the appropriate external components, the FAN5091 can be configured to deliver more than 50A of output current, as appropriate for the new generation of high-current processors. The FAN5091 functions as a fixed frequency PWM step down regulator, with a high efficiency mode (E*) at light load.

Main Control Loop

Refer to the FAN5091 Block Diagram on page 1. The FAN5091 consists of two interleaved synchronous buck converters, implemented with summing-mode control. Each slice has its own current feedback, and there is a common voltage feedback.

The two buck converters controlled by the FAN5091 are interleaved, that is, they run 180° out of phase with each other. This minimizes the RMS input ripple current, minimizing the number of input capacitors required. It also doubles the effective switching frequency, improving transient response.

The FAN5091 implements “summing mode control”, which is different from both classical voltage-mode and current-mode control. It provides superior performance to either by allowing a large converter bandwidth over a wide range of output loads and external components.

The control loop of the regulator contains two main sections: the analog control block and the digital control block. The analog section consists of signal conditioning amplifiers feeding into a comparator which provides the input to the digital control block. The signal conditioning section accepts inputs from a current sensor and a voltage sensor, with the voltage sensor being common to both slices, and the current sensor separate for each. The voltage sensor amplifies the difference between the VFB signal and the reference voltage from the DAC and presents the output to each of the two comparators. The current control path for each slice takes the difference between its PGND and SW pins when the low-side MOSFET is on, reproducing the voltage across the MOSFET and thus the input current; it presents the resulting signal to the same input of its summing amplifier, adding its signal to the voltage amplifier’s with a certain gain. These two signals are thus summed together. This sum is then presented to a comparator looking at the oscillator ramp, which provides the main PWM control signal to the digital control block. The oscillator ramps are 180° out of phase with each other, so that the two slices are on alternately.

The digital control block takes the analog comparator input to provide the appropriate pulses to the HDRV and LDRV output pins for each slice. These outputs control the external power MOSFETs.

Remote Voltage Sense

The FAN5091 has true remote voltage sense capability, eliminating errors due to trace resistance. To utilize remote sense, the VFB and AGND pins should be connected as a Kelvin trace pair to the point of regulation, such as the processor pins. The converter will maintain the voltage in regulation at that point. Care is required in layout of these grounds; see the layout guidelines in this datasheet.

High Current Output Drivers

The FAN5091 contains four high current output drivers that utilize MOSFETs in a push-pull configuration. The drivers for the high-side MOSFETs use the BOOT pin for input power and the SW pin for return. The drivers for the low-side MOSFETs use the VCC pin for input power and the PGND pin for return. Typically, the BOOT pin will use 12V directly. Note that the BOOT and VCC pins are separated from the chip’s internal power and ground, BYPASS and AGND, for switching noise immunity.

Adaptive Delay Gate Drive

The FAN5091 embodies an advanced design that ensures minimum MOSFET transition times while eliminating shoot-through current. It senses the state of the MOSFETs and adjusts the gate drive adaptively to ensure that they are never on simultaneously. When the high-side MOSFET turns off, the voltage on its source begins to fall. When the voltage there reaches approximately 2.5V, the low-side MOSFETs gate drive is applied with approximately 50nsec delay. When the low-side MOSFET turns off, the voltage at the LDRV pin is sensed. When it drops below approximately 2V, the high-side MOSFET’s gate drive is applied.

Maximum Duty Cycle

In order to ensure that the current-sensing and charge-pumping work, the FAN5091 guarantees that the low-side MOSFET will be on a certain portion of each period. For low frequencies, this occurs as a maximum duty cycle of approximately 90%. Thus at 500KHz, with a period of 2μsec, the low-side will be on at least $2\mu\text{sec} \cdot 10\% = 200\text{nsec}$. At higher frequencies, this time might fall so low as to be ineffective. The FAN5091 guarantees a minimum low-side on-time of approximately 330nsec, regardless of what duty cycle this corresponds to.

Current Sensing

The FAN5091 has two independent current sensors, one for each slice. Current sensing is accomplished by measuring the source-to-drain voltage of the low-side MOSFET during

its on-time. Each slice has its own power ground pin, to permit the slices to be placed in different locations without affecting measurement accuracy. For best results, it is important to connect the PGND and SW pins for each slice as a Kelvin trace pair directly to the source and drain, respectively, of the appropriate low-side MOSFET. Care is required in the layout of these grounds; see the layout guidelines in this datasheet.

Current Sharing

The two independent current sensors of the FAN5091 operate with their independent current control loops to guarantee that the two slices each deliver half of the total output current. The only mismatch between the two slices occurs if there is a mismatch between the $R_{DS,on}$ of the low-side MOSFETs.

Short Circuit Current Characteristics

The FAN5091 short circuit current characteristic includes a function that protects the DC-DC converter from damage in the event of a short circuit. The short circuit limit is set with the R_S resistor, as given by the formula

$$R_S(\Omega) = I_{SC} \cdot R_{DS,on} \cdot RT \cdot 6.66$$

with I_{SC} the desired current limit, RT the oscillator resistor and $R_{DS,on}$ one slice's low-side MOSFET's on resistance. Remember to make the R_S large enough to include the effects of initial tolerance and temperature variation on the MOSFETs' $R_{DS,on}$. It is recommended to set I_{SC} substantially above maximum operating current, to avoid nuisance trips.

Important Note! The oscillator frequency must be selected before selecting the current limit resistor, because the value of RT is used in the calculation of R_S .

When an overcurrent is detected, the high-side MOSFETs are turned off, and the low-side MOSFETs are turned on, and they remain in this state until the measured current through the low-side MOSFET has returned to zero amps. After reaching zero, the FAN5091 re-soft-starts, ensuring that it can also safely turn on into a short.

A limitation on the current sense circuit is that $I_{SC} \cdot R_{DS,on}$ must be less than 375mV. To ensure correct operation, use $I_{SC} \cdot R_{DS,on} \leq 300\text{mV}$; between 300mV and 375mV, there will be some non-linearity in the short-circuit current not accounted for in the equation.

As an example, consider the typical characteristic of the DC-DC converter circuit with two FDP6670AL low-side MOSFETs ($R_{DS} = 6.5\text{m}\Omega$ maximum at $25^\circ\text{C} \cdot 1.2$ at $75^\circ\text{C} = 7.8\text{m}\Omega$ each, or $3.9\text{m}\Omega$ total) in each slice, $RT = 42.1\text{K}\Omega$ (600KHz oscillator) and a $50\text{K}\Omega R_S$.

The converter exhibits a normal load regulation characteristic until the voltage across the MOSFETs exceeds the internal short circuit threshold of $50\text{K}\Omega / (3.9\text{m}\Omega \cdot 41.2\text{K}\Omega \cdot 6.66)$

$= 47\text{A}$. [Note that this current limit level can be as high as $50\text{K}\Omega / (3.5\text{m}\Omega \cdot 41.2\text{K}\Omega \cdot 6.66) = 52\text{A}$, if the MOSFETs have typical $R_{DS,on}$ rather than maximum, and are at 25°C .] At this point, the internal comparator trips and signals the controller to leave on the low-side MOSFETs and keep off the high-side MOSFETs. The inductor current decreases, and power is not applied again until the inductor current reaches 0A and the converter attempts to re-softstart.

Precision Current Sensing

The tolerances associated with the use of MOSFET current sensing can be circumvented by the use of a current sense resistor, as provided for by the FAN5092.

Light Load Efficiency

At light load, the FAN5091 uses a number of techniques to improve efficiency. Because a synchronous buck converter is two quadrant, able to both source and sink current, during light load the inductor current will flow away from the output and towards the input during a portion of the switching cycle. This reverse current flow is detected by the FAN5091 as a positive voltage appearing on the low-side MOSFET during its on-time. When reverse current flow is detected, the low-side MOSFET is turned off for the rest of the cycle, and the current instead flows through the body diode of the high-side MOSFET, returning the power to the source. This technique substantially enhances light load efficiency.

E*-mode

In addition, further enhancement in efficiency can be obtained by putting the FAN5091 into E*-mode. When the Droop pin is pulled to the 5V BYPASS voltage, the "A" slice of the FAN5091 is completely turned off, reducing in half the amount of gate charge power being consumed. E*-mode can be implemented with the circuit shown in Figure 5:

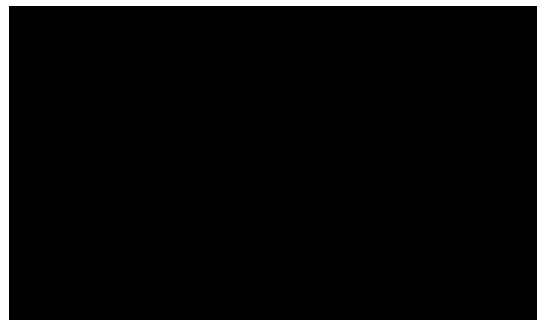

Figure 5. Implementing E*-mode Control

Internal Voltage Reference

The reference included in the FAN5091 is a precision band-gap voltage reference. Its internal resistors are precisely trimmed to provide a near zero temperature coefficient (TC). Based on the reference is the output from an integrated 5-bit DAC. The DAC monitors the 5 voltage identification pins, VID0-4, and scales the reference voltage from 1.100V to 1.850V in 25mV steps.

BYPASS Reference

The internal logic of the FAN5091 runs on 5V. To permit the IC to run with 12V only, it produces 5V internally with a linear regulator, whose output is present on the BYPASS pin. This pin should be bypassed with a 1 μ F capacitor for noise suppression. The BYPASS pin should not have any external load attached to it.

Dynamic Voltage Adjustment

The FAN5091 has internal pullups on its VID lines. External pullups should not be used. The FAN5091 can have its output voltage dynamically adjusted to accommodate low power modes. The designer must ensure that the transitions on the VID lines all occur simultaneously (within less than 500nsec) to avoid false codes generating undesired output voltages. The Power Good flag tracks the VID codes, but has a 500 μ sec delay transitioning from high to low; this is long enough to ensure that there will not be any glitches during dynamic voltage adjustment.

Power Good (PWRGD)

The FAN5091 Power Good function is designed in accordance with the Pentium IV DC-DC converter specifications and provides a continuous voltage monitor on the VFB pin. The circuit compares the VFB signal to the VREF voltage and outputs an active-low interrupt signal to the CPU should the power supply voltage deviate more than +14%/-9% of its nominal setpoint. The output is guaranteed open-collector high when the power supply voltage is within +6%/-11% of its nominal setpoint. The Power Good flag provides no control functions to the FAN5091.

Output Enable/Soft Start (ENABLE/SS)

The FAN5091 will accept an open collector/TTL signal for controlling the output voltage. The low state disables the output voltage. When disabled, the PWRGD output is in the low state.

Even if an enable is not required in the circuit, this pin should have attached a capacitor (typically 100nF) to soft-start the switching. A softstart capacitor may be approximately chosen by the formula:

$$C = \frac{t \cdot 10\mu A}{1 + V_{out}}$$

However, C must be ≥ 10 nF.

Oscillator

The FAN5091 oscillator section runs at a frequency determined by a resistor from the RT pin to ground according to the formula

$$RT(\Omega) = \frac{25 \cdot 10^9}{f(\text{Hz})}$$

The oscillator generates two internal sawtooth ramps, each at one-half the oscillator frequency, and running 180° out of phase with each other. These ramps cause the turn-on time of the two slices to be phased apart. The oscillator frequency of the FAN5091 can be programmed from 200KHz to 2MHz with each slice running at 100KHz to 1MHz, respectively. Selection of a frequency will depend on various system performance criteria, with higher frequency resulting in smaller components but lower efficiency.

Programmable Active Droop™

The FAN5091 features Programmable Active Droop™: as the output current increases, the output voltage drops proportionately an amount that can be programmed with an external resistor. This feature is offered in order to allow maximum headroom for transient response of the converter. The current is sensed losslessly by measuring the voltage across the low-side MOSFET during its on time. Consult the section on current sensing for details. Note that this method makes the droop dependent on the temperature and initial tolerance of the MOSFET, and the droop must be calculated taking account of these tolerances. Given a maximum output current, the amount of droop can be programmed with a resistor to ground on the droop pin, according to the formula

$$R_{\text{Droop}}(\Omega) = \frac{V_{\text{Droop}} \cdot RT}{I_{\text{max}} \cdot R_{\text{DS, on}}}$$

with V_{Droop} the desired droop voltage, RT the oscillator resistor, I_{max} the output current at which the droop is desired, and $R_{\text{DS, on}}$ the on-state resistance of one slice's low-side MOSFET.

Typical response time of the FAN5091 to an output voltage change is 100nsec.

Important Note! The oscillator frequency must be selected before selecting the droop resistor, because the value of RT is used in the calculation of R_{Droop} .

Higher Current Converters

Active droop makes it possible to parallel multiple FAN5091s for even higher output current requirements. Synchronized parallelization may be obtained with the similar FAN5094. Please refer to Application Bulletin AB-XX for details.

Over-Voltage Protection

The FAN5091 constantly monitors the output voltage for protection against over-voltage conditions. If the voltage at the VFB pin exceeds 2.2V, an over-voltage condition is assumed and the FAN5091 latches on the external low-side MOSFET and latches off the high-side MOSFET. The DC-DC converter returns to normal operation only after V_{CC} has been recycled.

Thermal Design Considerations

Because of the very large gate capacitances that the FAN5091 may be driving, the IC may dissipate substantial power. It is important to provide a path for the IC's heat to be removed, to avoid overheating. In practice, this means that each of the pins should be connected to as large a trace as possible. Use of the heavier weights of copper on the PCB is also desirable. Since the MOSFETs also generate a lot of heat, efforts should be made to thermally isolate them from the IC.

Over Temperature Protection

If the FAN5091 die temperature exceeds approximately 150°C, the IC shuts itself off. It remains off until the temperature has dropped approximately 40°C, at which time it resumes normal operation.

Component Selection

MOSFET Selection

This application requires N-channel Enhancement Mode Field Effect Transistors. Desired characteristics are as follows:

- Low Drain-Source On-Resistance,
- $R_{DS,ON} < 10m\Omega$ (lower is better);
- Power package with low Thermal Resistance;
- Drain-Source voltage rating $> 15V$;
- Low gate charge, especially for higher frequency operation.

For the low-side MOSFET, the on-resistance ($R_{DS,ON}$) is the primary parameter for selection. Because of the small duty cycle of the high-side, the on-resistance determines the power dissipation in the low-side MOSFET and therefore significantly affects the efficiency of the DC-DC converter. For high current applications, it may be necessary to use two MOSFETs in parallel for the low-side for each slice.

For the high-side MOSFET, the gate charge is as important as the on-resistance, especially with a 12V input and with higher switching frequencies. This is because the speed of the transition greatly affects the power dissipation. It may be a good trade-off to select a MOSFET with a somewhat higher $R_{DS,on}$, if by so doing a much smaller gate charge is available. For high current applications, it may be necessary to use two MOSFETs in parallel for the high-side for each slice.

At the FAN5091's highest operating frequencies, it may be necessary to limit the total gate charge of both the high-side and low-side MOSFETs together, to avert excess power dissipation in the IC.

For details and a spreadsheet on MOSFET selection, refer to Applications Bulletin AB-8.

Gate Resistors

Use of a gate resistor on every MOSFET is mandatory. The gate resistor prevents high-frequency oscillations caused by the trace inductance ringing with the MOSFET gate capacitance. The gate resistors should be located physically as close to the MOSFET gate as possible.

The gate resistor also limits the power dissipation inside the IC, which could otherwise be a limiting factor on the switching frequency. It may thus carry significant power, especially at higher frequencies. As an example, consider the gate resistors used for the low-side MOSFETs (Q2 and Q4) in Figure 1. The FDB7045L has a maximum gate charge of 70nC at 5V, and an input capacitance of 5.4nF. The total energy used in powering the gate during one cycle is the energy needed to get it up to 5V, plus the energy to get it up to 12V:

$$E = QV + \frac{1}{2}C \cdot \Delta V^2 = 70nC \cdot 5V + \frac{1}{2}5.4nF \cdot (12V - 5V)^2 = 482nJ$$

This power is dissipated every cycle, and is divided between the internal resistance of the FAN5091 gate driver and the gate resistor. Thus,

$$P_{R_{gate}} = \frac{E \cdot f \cdot R_{gate}}{(R_{gate} + R_{internal})} = \frac{482nJ \cdot 300KHz \cdot 4.7\Omega}{4.7\Omega + 1.0\Omega} = 19mW$$

and each gate resistor thus requires a 1/4W resistor to ensure worst case power dissipation.

The same calculation may be performed for the high-side MOSFETs, bearing in mind that their gate voltage rises to only $(12V-5V) = 7V$.

Inductor Selection

Choosing the value of the inductor is a tradeoff between allowable ripple voltage and required transient response. A smaller inductor produces greater ripple while producing better transient response. In any case, the minimum inductance is determined by the allowable ripple. The first order equation (close approximation) for minimum inductance for a two-slice converter is:

$$L_{min} = \frac{V_{in} - 2 \cdot V_{out}}{f} \cdot \frac{V_{out}}{V_{in}} \cdot \frac{ESR}{V_{ripple}}$$

where:

V_{in} = Input Power Supply

V_{out} = Output Voltage

f = DC/DC converter switching frequency
 ESR = Equivalent series resistance of all output capacitors in parallel
 Vripple = Maximum peak to peak output ripple voltage budget.

One other limitation on the minimum size of the inductor is caused by the current feedback loop stability criterion. The inductor must be greater than:

$$L \geq 3 \cdot 10^{-10} \cdot R_{DS, on} \cdot R_{Droop} \cdot (V_{in} - 2V_o)$$

where L is the inductance in Henries, $R_{DS, on}$ is the on-state resistance of one slice's low-side MOSFET, R_{Droop} is the value of the droop resistor in Ohms, V_{in} is either 5V or 12V, and V_o is the output voltage. For most applications, this formula will not present any limitation on the selection of the inductor value.

A typical value for the inductor is 1.3 μ H at an oscillator frequency of 600KHz (300KHz each slice) and 220nH at an oscillator frequency of 2MHz (1MHz each slice). For other frequencies, use the interpolating formula

$$L(\text{nH}) \approx \frac{930,000}{f(\text{KHz})} - 240$$

Schottky Diode Selection

The application circuits of Figures 1-3 show a Schottky diode, D1 (D2 respectively), one in each slice. They are used as free-wheeling diodes to ensure that the body-diodes in the low-side MOSFETs do not conduct when the upper MOSFET is turning off and the lower MOSFETs are turning on. It is undesirable for this diode to conduct because its high forward voltage drop and long reverse recovery time degrades efficiency, and so the Schottky provides a shunt path for the current. Since this time duration is extremely short, being minimized by the adaptive gate delay, the selection criterion for the diode is that the forward voltage of the Schottky at the output current should be less than the forward voltage of the MOSFET's body diode. Power capability is not a criterion for this device, as its dissipation is very small.

Output Filter Capacitors

The output bulk capacitors of a converter help determine its output ripple voltage and its transient response. It has already been seen in the section on selecting an inductor that the ESR helps set the minimum inductance. For most converters, the number of capacitors required is determined by the transient response and the output ripple voltage, and these are determined by the ESR and not the capacitance value. That is, in order to achieve the necessary ESR to meet the transient and ripple requirements, the capacitance value required is already very large.

The most commonly used choice for output bulk capacitors is aluminum electrolytics, because of their low cost and low ESR. The only type of aluminum capacitor used should be those that have an ESR rated at 100kHz. Consult Application Bulletin AB-14 for detailed information on output capacitor selection.

For higher frequency applications, particularly those running the FAN5091 oscillator at >1MHz, Oscon or ceramic capacitors may be considered. They have much smaller ESR than comparable electrolytics, but also much smaller capacitance.

The output capacitance should also include a number of small value ceramic capacitors placed as close as possible to the processor; 0.1 μ F and 0.01 μ F are recommended values.

Input Filter

The DC-DC converter design may include an input inductor between the system main supply and the converter input as shown in Figure 6. This inductor serves to isolate the main supply from the noise in the switching portion of the DC-DC converter, and to limit the inrush current into the input capacitors during power up. A value of 1.3 μ H is recommended.

It is necessary to have some low ESR capacitors at the input to the converter. These capacitors deliver current when the high side MOSFET switches on. Because of the interleaving, the number of such capacitors required is greatly reduced from that required for a single-slice buck converter. Figure 6 shows 3 x 1000 μ F, but the exact number required will vary with the output voltage and current, according to the formula

$$I_{rms} = \frac{I_{out}}{2} \sqrt{2DC - 4DC^2}$$

for the two slice FAN5091, where DC is the duty cycle, $DC = V_{out} / V_{in}$. Capacitor ripple current rating is a function of temperature, and so the manufacturer should be contacted to find out the ripple current rating at the expected operational temperature. For details on the design of an input filter, refer to Applications Bulletin AB-16.

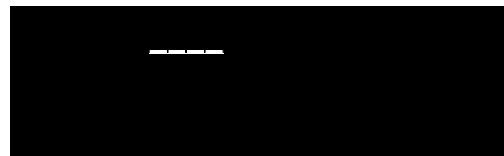

Figure 6. Input Filter

Design Considerations and Component Selection

Additional information on design and component selection may be found in Fairchild's Application Note 59.

PCB Layout Guidelines

- Placement of the MOSFETs relative to the FAN5091 is critical. Place the MOSFETs such that the trace length of the HIDRV and LODRV pins of the FAN5091 to the FET gates is minimized. A long lead length on these pins will cause high amounts of ringing due to the inductance of the trace and the gate capacitance of the FET. This noise radiates throughout the board, and, because it is switching at such a high voltage and frequency, it is very difficult to suppress.
- In general, all of the noisy switching lines should be kept away from the quiet analog section of the FAN5091. That is, traces that connect to pins 8-17 (LODRV, HIDRV, PGND and BOOT) should be kept far away from the traces that connect to pins 1 through 7, and pins 18-24.
- Place the 0.1 μ F decoupling capacitors as close to the FAN5091 pins as possible. Extra lead length on these reduces their ability to suppress noise.
- Each power and ground pin should have its own via to the appropriate plane. This helps provide isolation between pins.
- Place the MOSFETs, inductor, and Schottky of a given slice as close together as possible for the same reasons as in the first bullet above. Place the input bulk capacitors as close to the drains of the high side MOSFETs as possible. In addition, placement of a 0.1 μ F decoupling cap right on the drain of each high side MOSFET helps to suppress some of the high frequency switching noise on the input of the DC-DC converter.
- Place the output bulk capacitors as close to the CPU as possible to optimize their ability to supply instantaneous current to the load in the event of a current transient. Additional space between the output capacitors and the CPU will allow the parasitic resistance of the board traces to degrade the DC-DC converter's performance under severe load transient conditions, causing higher voltage deviation. For more detailed information regarding capacitor placement, refer to Application Bulletin AB-5.
- A PC Board Layout Checklist is available from Fairchild Applications. Ask for Application Bulletin AB-11.

PC Motherboard Sample Layout and Gerber File

A reference design for motherboard implementation of the FAN5091 along with the PCAD layout Gerber file and silk screen can be obtained through your local Fairchild representative.

FAN5091 Evaluation Board

Fairchild provides an evaluation board to verify the system level performance of the FAN5091. It serves as a guide to performance expectations when using the supplied external components and PCB layout. Please contact your local Fairchild representative for an evaluation board.

Additional Information

For additional information contact your local Fairchild representative.

Mechanical Dimensions – 24 Lead TSSOP

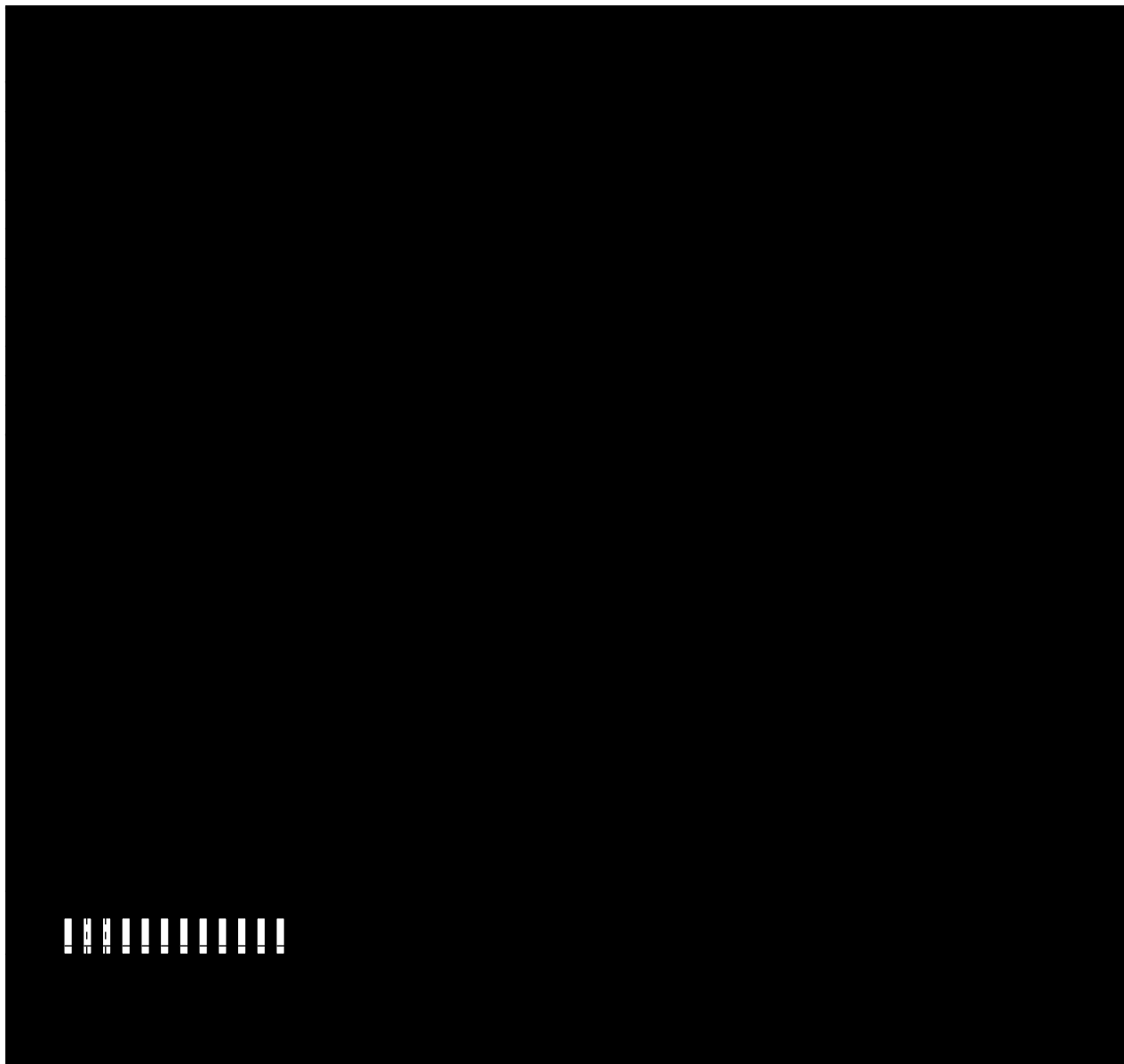

Ordering Information

Product Number	Description	Package
FAN5091MTC	5V	24 pin TSSOP

DISCLAIMER

FAIRCHILD SEMICONDUCTOR RESERVES THE RIGHT TO MAKE CHANGES WITHOUT FURTHER NOTICE TO ANY PRODUCTS HEREIN TO IMPROVE RELIABILITY, FUNCTION OR DESIGN. FAIRCHILD DOES NOT ASSUME ANY LIABILITY ARISING OUT OF THE APPLICATION OR USE OF ANY PRODUCT OR CIRCUIT DESCRIBED HEREIN; NEITHER DOES IT CONVEY ANY LICENSE UNDER ITS PATENT RIGHTS, NOR THE RIGHTS OF OTHERS.

LIFE SUPPORT POLICY

FAIRCHILD'S PRODUCTS ARE NOT AUTHORIZED FOR USE AS CRITICAL COMPONENTS IN LIFE SUPPORT DEVICES OR SYSTEMS WITHOUT THE EXPRESS WRITTEN APPROVAL OF THE PRESIDENT OF FAIRCHILD SEMICONDUCTOR CORPORATION. As used herein:

1. Life support devices or systems are devices or systems which, (a) are intended for surgical implant into the body, or (b) support or sustain life, and (c) whose failure to perform when properly used in accordance with instructions for use provided in the labeling, can be reasonably expected to result in a significant injury of the user.
2. A critical component in any component of a life support device or system whose failure to perform can be reasonably expected to cause the failure of the life support device or system, or to affect its safety or effectiveness.

Search input field with a search icon

Buttons: space, Product Folders and, Apply

find products

Home >> Find products >>

Products groups

Analog and Mixed

Signal

Discrete

Interface

Logic

Microcontrollers

Non-Volatile

Memory

Optoelectronics

Markets and

applications

New products

Product selection and

parametric search

Cross-reference

search

technical information

buy products

technical support

my Fairchild

company

FAN5091

Two Phase Interleaved Synchronous Buck Converter

Contents

General description | Features | Applications |

Product status/pricing/packaging |

Application notes

Datasheet

Download this

datasheet

PDF

e-mail this datasheet

[E-]

This page

Print version

Related Links

Request samples

Dotted line

How to order products

Dotted line

Product Change Notices

(PCNs)

Dotted line

Support

Dotted line

Distributor and field sales

representatives

Dotted line

Quality and reliability

Dotted line

Design tools

General description

The FAN5091 is a synchronous multi-slice DC-DC controller IC which provides a highly accurate, programmable output voltage for all high-performance processors. Two interleaved synchronous buck regulator slices with built-in current shar-ing operate 180° out of phase to provide the fast transient response needed to satisfy high current applications while minimizing external components. The FAN5091 features remote voltage sensing, and Programmable Active Droop™ for 100nsec converter transient response with minimum output capacitance. It has integrated high-current gate drivers, with adaptive delay gate switching, eliminating the need for external drive devices. The FAN5091 uses a 5-bit D/A con-verter to program the output voltage from 1.10V to 1.85V in 25mV steps with an accuracy of 1%. The FAN5091 uses a high level of integration to deliver load currents in excess of 50A from a 5V source with minimal external circuitry. The FAN5091 also offers integrated functions including Power Good, Output Enable/Soft Start, under-volt-age lockout, over-voltage protection, and adjustable current limiting with independent current sense on each slice. It is available in a 24 pin TSSOP package.

back to top

Features

- Programmable output from 1.10V to 1.85V in 25mV steps using an integrated 5-bit DAC
- Two interleaved synchronous slices for maximum performance
- 100nsec response time
- Built-in current sharing between slices
- Remote sense
- Programmable Active Droop™ (Voltage Positioning)
- Programmable frequency from 200KHz to 2MHz
- Adaptive delay gate switching
- Integrated high-current gate drivers
- Integrated Power Good, OV, UV, Enable/Soft Start functions
- Drives N-channel MOSFETs
- Operation optimized for both 5V and 12V operation
- High efficiency mode (E*) at light load
- Overcurrent protection using MOSFET sensing
- 24 pin TSSOP package

[back to top](#)

Applications

- Power supply for Pentium® IV
- Power supply for Athlon®
- VRM for Pentium IV processor
- Programmable step-down power supply

[back to top](#)

Product status/pricing/packaging

Product	Product status	Pricing*	Package type	Leads	Package marking	Packing method
FAN5091MTC	Full Production	\$3.00	TSSOP	24	\$Y&Z&2&T 5091MTC C	RAIL
FAN5091MTCX	Full Production	\$3.00	TSSOP	24	\$Y&Z&2&T 5091MTC C	TAPE REEL

* 1,000 piece Budgetary Pricing

[back to top](#)

Application notes

[AB-24: AB-24 Understanding Droop and Programmable Active Droop™](#)

(161 K) Jul 19, 2002

[FAN5093-PB: FAN5093 Product Brief](#) (115 K) Jul 19, 2002

[back to top](#)

[Home](#) | [Find products](#) | [Technical information](#) | [Buy products](#) |
[Support](#) | [Company](#) | [Contact us](#) | [Site index](#) | [Privacy policy](#)

[© Copyright 2002 Fairchild Semiconductor](#)
