

MRF6S9130HR3/HSR3 replaced by MRFE6S9130HR3/HSR3. Refer to Device Migration PCN12895 for more details.

## RF Power Field Effect Transistors

### N-Channel Enhancement-Mode Lateral MOSFETs

Designed for N-CDMA, GSM and GSM EDGE base station applications with frequencies from 865 to 960 MHz. Suitable for multicarrier amplifier applications.

- Typical Single-Carrier N-CDMA Performance @ 880 MHz:  $V_{DD} = 28$  Volts,  $I_{DQ} = 950$  mA,  $P_{out} = 27$  Watts Avg., Full Frequency Band, IS-95 CDMA (Pilot, Sync, Paging, Traffic Codes 8 Through 13) Channel Bandwidth = 1.2288 MHz. PAR = 9.8 dB @ 0.01% Probability on CCDF.  
 Power Gain — 19.2 dB  
 Drain Efficiency — 30.5%  
 ACPR @ 750 kHz Offset — -48.1 dBc in 30 kHz Bandwidth

#### GSM Application

- Typical GSM Performance:  $V_{DD} = 28$  Volts,  $I_{DQ} = 950$  mA,  $P_{out} = 130$  Watts, Full Frequency Band (921 - 960 MHz)  
 Power Gain — 18 dB  
 Drain Efficiency — 63%

#### GSM EDGE Application

- Typical GSM EDGE Performance:  $V_{DD} = 28$  Volts,  $I_{DQ} = 950$  mA,  $P_{out} = 56$  Watts Avg., Full Frequency Band (921 - 960 MHz)  
 Power Gain — 18.5 dB  
 Drain Efficiency — 44%  
 Spectral Regrowth @ 400 kHz Offset = -63 dBc  
 Spectral Regrowth @ 600 kHz Offset = -75 dBc  
 EVM — 1.5% rms
- Capable of Handling 10:1 VSWR, @ 28 Vdc, 880 MHz, 130 Watts CW Output Power

#### Features

- Characterized with Series Equivalent Large-Signal Impedance Parameters
- Internally Matched for Ease of Use
- Qualified Up to a Maximum of 32  $V_{DD}$  Operation
- Integrated ESD Protection
- RoHS Compliant
- In Tape and Reel. R3 Suffix = 250 Units per 56 mm, 13 inch Reel.

**Table 1. Maximum Ratings**

Rating	Symbol	Value	Unit
Drain-Source Voltage	$V_{DSS}$	-0.5, +68	Vdc
Gate-Source Voltage	$V_{GS}$	-0.5, +12	Vdc
Storage Temperature Range	$T_{stg}$	- 65 to +150	°C
Case Operating Temperature	$T_C$	150	°C
Operating Junction Temperature (1,2)	$T_J$	225	°C

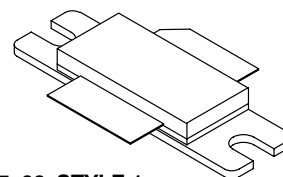
**Table 2. Thermal Characteristics**

Characteristic	Symbol	Value (2,3)	Unit
Thermal Resistance, Junction to Case Case Temperature 80°C, 130 W CW Case Temperature 75°C, 27 W CW	$R_{\theta JC}$	0.45 0.51	°C/W

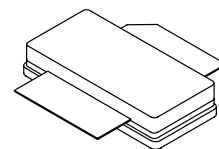
1. Continuous use at maximum temperature will affect MTTF.
2. MTTF calculator available at <http://www.freescale.com/rf>. Select Software & Tools/Development Tools/Calculators to access MTTF calculators by product.
3. Refer to AN1955, *Thermal Measurement Methodology of RF Power Amplifiers*. Go to <http://www.freescale.com/rf>. Select Documentation/Application Notes - AN1955.

**MRF6S9130HR3**  
**MRF6S9130HSR3**

**880 MHz, 27 W AVG., 28 V**  
**SINGLE N-CDMA**  
**LATERAL N-CHANNEL**  
**RF POWER MOSFETs**



**CASE 465-06, STYLE 1**  
**NI-780**  
**MRF6S9130HR3**



**CASE 465A-06, STYLE 1**  
**NI-780S**  
**MRF6S9130HSR3**

ARCHIVE INFORMATION

ARCHIVE INFORMATION

**Table 3. ESD Protection Characteristics**

Test Methodology	Class
Human Body Model (per JESD22-A114)	1A (Minimum)
Machine Model (per EIA/JESD22-A115)	A (Minimum)
Charge Device Model (per JESD22-C101)	IV (Minimum)

**Table 4. Electrical Characteristics** ( $T_C = 25^\circ\text{C}$  unless otherwise noted)

Characteristic	Symbol	Min	Typ	Max	Unit
<b>Off Characteristics</b>					
Zero Gate Voltage Drain Leakage Current ( $V_{DS} = 68\text{ Vdc}$ , $V_{GS} = 0\text{ Vdc}$ )	$I_{DSS}$	—	—	10	$\mu\text{Adc}$
Zero Gate Voltage Drain Leakage Current ( $V_{DS} = 28\text{ Vdc}$ , $V_{GS} = 0\text{ Vdc}$ )	$I_{DSS}$	—	—	1	$\mu\text{Adc}$
Gate-Source Leakage Current ( $V_{GS} = 5\text{ Vdc}$ , $V_{DS} = 0\text{ Vdc}$ )	$I_{GSS}$	—	—	1	$\mu\text{Adc}$

**On Characteristics**

Gate Threshold Voltage ( $V_{DS} = 10\text{ Vdc}$ , $I_D = 400\ \mu\text{Adc}$ )	$V_{GS(th)}$	1	2.1	3	Vdc
Gate Quiescent Voltage ( $V_{DD} = 28\text{ Vdc}$ , $I_D = 950\ \text{mA}$ , Measured in Functional Test)	$V_{GS(Q)}$	2	2.9	4	Vdc
Drain-Source On-Voltage ( $V_{GS} = 10\text{ Vdc}$ , $I_D = 2.74\ \text{A}$ )	$V_{DS(on)}$	—	0.22	0.5	Vdc

**Dynamic Characteristics** <sup>(1)</sup>

Output Capacitance ( $V_{DS} = 28\text{ Vdc} \pm 30\ \text{mV(rms)ac}$ @ 1 MHz, $V_{GS} = 0\text{ Vdc}$ )	$C_{OSS}$	—	66	—	pF
Reverse Transfer Capacitance ( $V_{DS} = 28\text{ Vdc} \pm 30\ \text{mV(rms)ac}$ @ 1 MHz, $V_{GS} = 0\text{ Vdc}$ )	$C_{RSS}$	—	1.6	—	pF

**Functional Tests** (In Freescale Test Fixture, 50 ohm system)  $V_{DD} = 28\text{ Vdc}$ ,  $I_{DQ} = 950\ \text{mA}$ ,  $P_{out} = 27\ \text{W Avg.}$  N-CDMA,  $f = 880\ \text{MHz}$ , Single-Carrier N-CDMA, 1.2288 MHz Channel Bandwidth Carrier. ACPR measured in 30 kHz Channel Bandwidth @  $\pm 750\ \text{kHz}$  Offset. PAR = 9.8 dB @ 0.01% Probability on CCDF

Power Gain	$G_{ps}$	18	19.2	21	dB
Drain Efficiency	$\eta_D$	29	30.5	—	%
Adjacent Channel Power Ratio	ACPR	—	-48.1	-46	dBc
Input Return Loss	IRL	—	-30	-9	dB

**Typical GSM EDGE Performances** (In Freescale GSM EDGE Test Fixture, 50 ohm system)  $V_{DD} = 28\text{ Vdc}$ ,  $I_{DQ} = 950\ \text{mA}$ ,  $P_{out} = 56\ \text{W Avg.}$ , 921 MHz < Frequency < 960 MHz

Power Gain	$G_{ps}$	—	18.5	—	dB
Drain Efficiency	$\eta_D$	—	44	—	%
Error Vector Magnitude	EVM	—	1.5	—	% rms
Spectral Regrowth at 400 kHz Offset	SR1	—	-63	—	dBc
Spectral Regrowth at 600 kHz Offset	SR2	—	-75	—	dBc

**Typical CW Performances** (In Freescale GSM Test Fixture, 50 ohm system)  $V_{DD} = 28\text{ Vdc}$ ,  $I_{DQ} = 950\ \text{mA}$ ,  $P_{out} = 130\ \text{W}$ , 921 MHz < Frequency < 960 MHz

Power Gain	$G_{ps}$	—	18	—	dB
Drain Efficiency	$\eta_D$	—	63	—	%
Input Return Loss	IRL	—	-12	—	dB
$P_{out}$ @ 1 dB Compression Point, CW ( $f = 940\ \text{MHz}$ )	$P_{1dB}$	—	135	—	W

1. Part is internally matched on input.

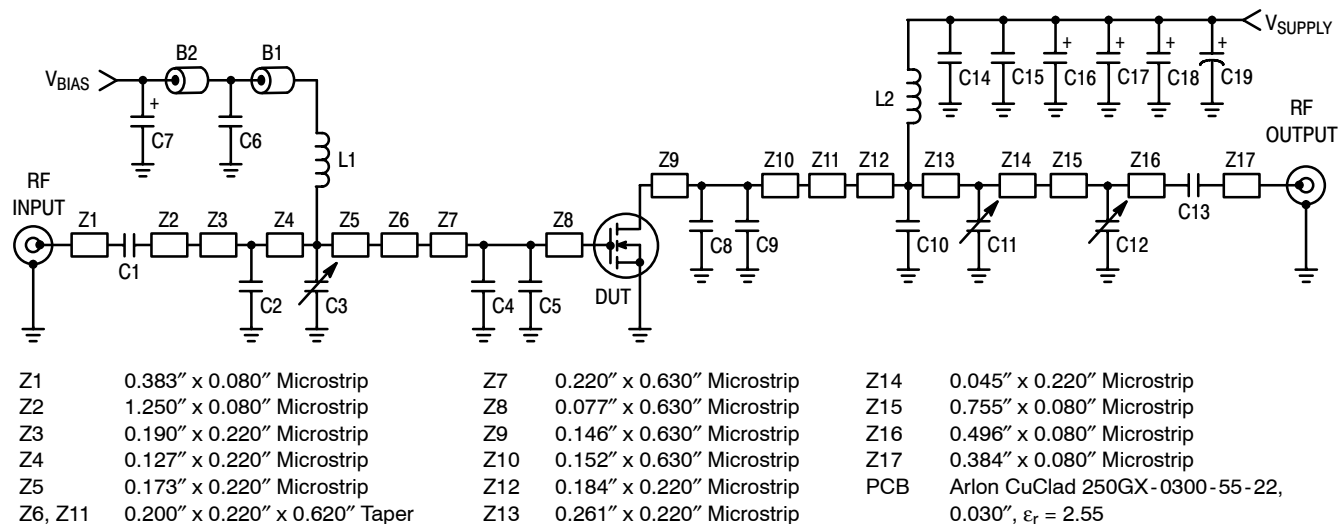


Figure 1. MRF6S9130HR3(SR3) Test Circuit Schematic

Table 5. MRF6S9130HR3(SR3) Test Circuit Component Designations and Values

Part	Description	Part Number	Manufacturer
B1, B2	Ferrite Beads, Short	2743019447	Fair Rite
C1, C13, C14	47 pF Chip Capacitors	ATC100B470JT500XT	ATC
C2	8.2 pF Chip Capacitor	ATC100B8R2BT500XT	ATC
C3, C11	0.8 - 8.0 pF Variable Capacitors, Gigatrim	27291SL	Johanson
C4, C5	12 pF Chip Capacitors	ATC100B120JT500XT	ATC
C6	20 K pF Chip Capacitor	ATC200B203KT50XT	ATC
C7, C16, C17, C18	10 $\mu$ F, 35 V Tantalum Chip Capacitors	T491D106K035AT	Kemet
C8, C9	10 pF Chip Capacitors	ATC100B7R5JT500XT	ATC
C10	11 pF Chip Capacitor	ATC100B110JT500XT	ATC
C12	0.6 - 4.5 pF Variable Capacitor, Gigatrim	27271SL	Johanson
C15	0.56 $\mu$ F, 50 V Chip Capacitor	C1825C564J5GAC	Kemet
C19	470 $\mu$ F, 63 V Electrolytic Capacitor	EKME630ELL471MK25S	United Chemi-Con
L1, L2	12.5 nH Inductors	A04T-5	Coilcraft

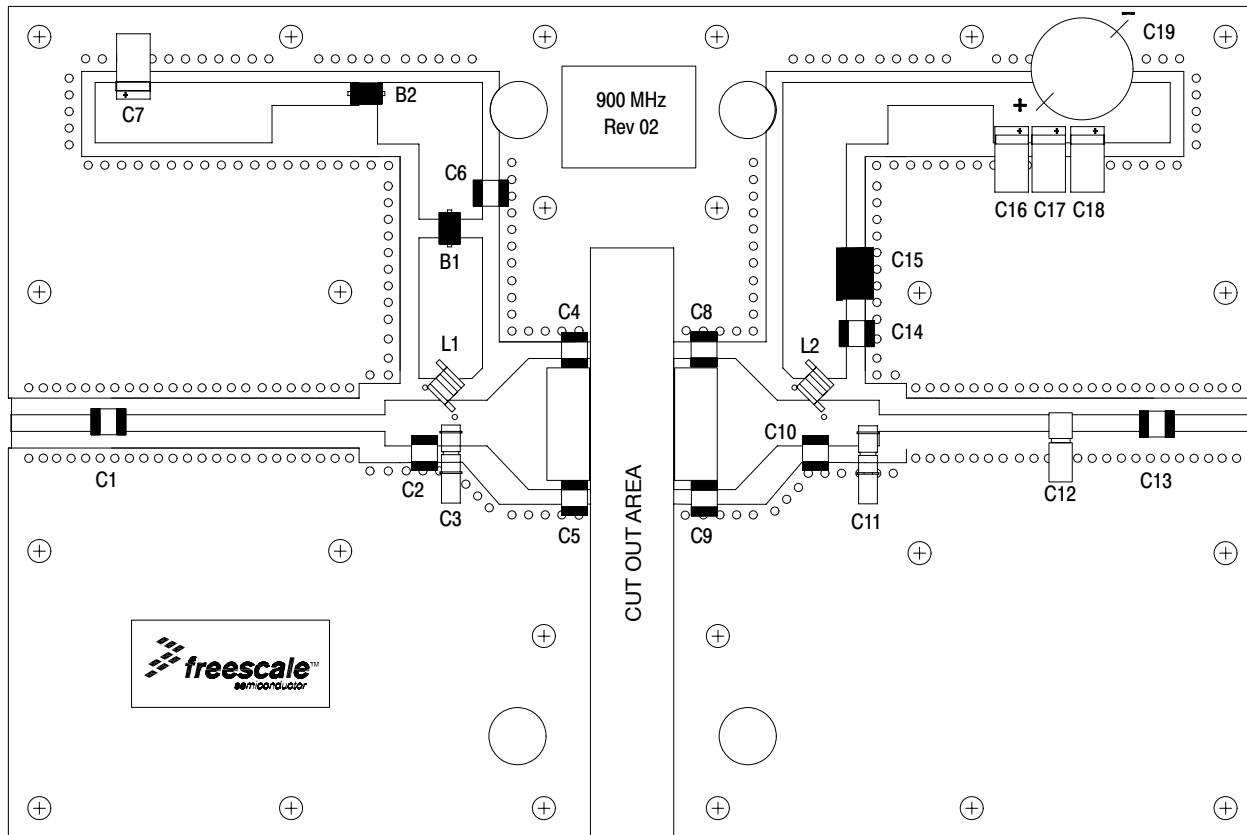


Figure 2. MRF6S9130HR3(SR3) Test Circuit Component Layout

ARCHIVE INFORMATION

ARCHIVE INFORMATION

### TYPICAL CHARACTERISTICS

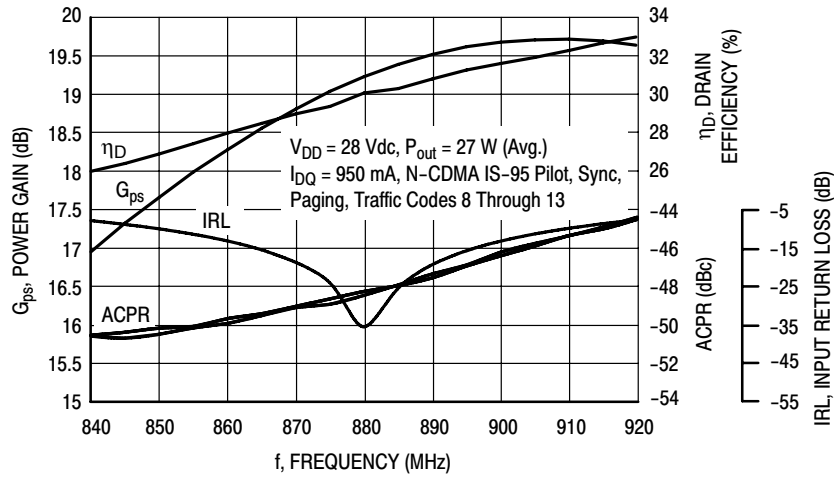


Figure 3. Single-Carrier N-CDMA Broadband Performance @  $P_{out} = 27$  Watts Avg.

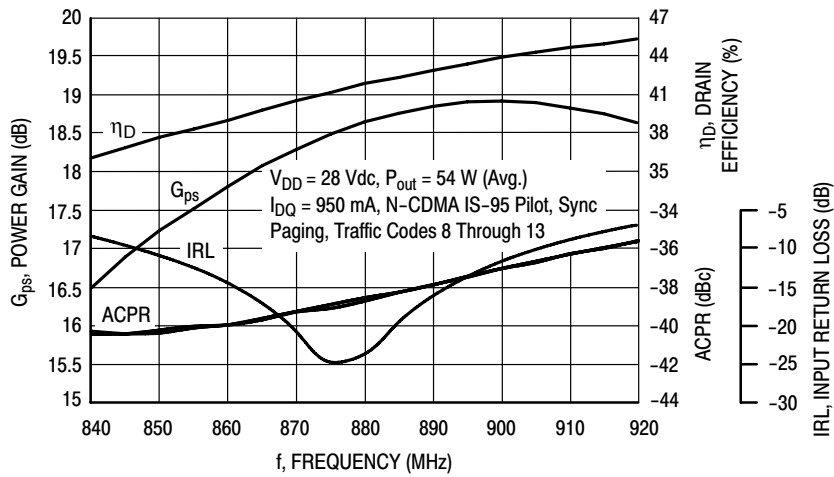


Figure 4. Single-Carrier N-CDMA Broadband Performance @  $P_{out} = 54$  Watts Avg.

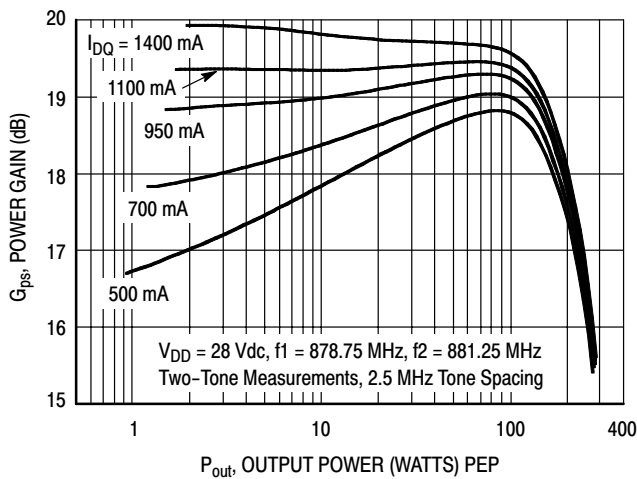


Figure 5. Two-Tone Power Gain versus Output Power

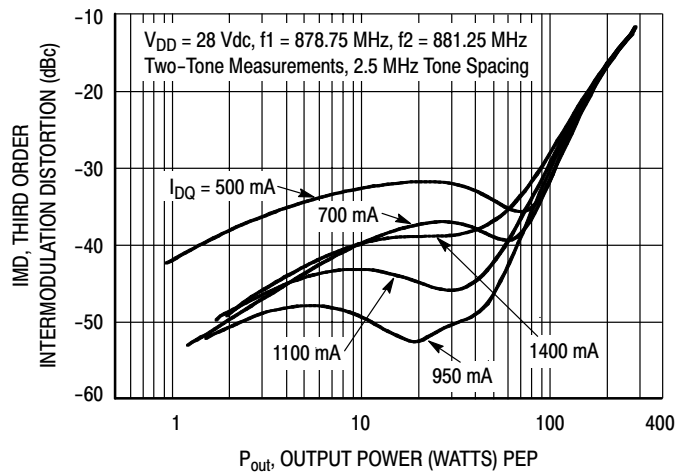
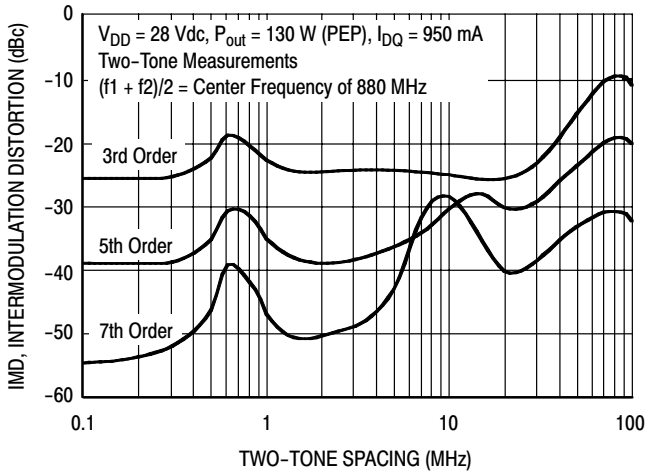
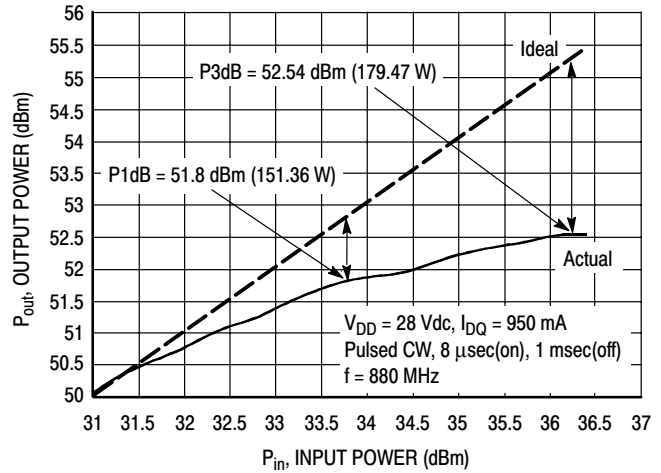


Figure 6. Third Order Intermodulation Distortion versus Output Power

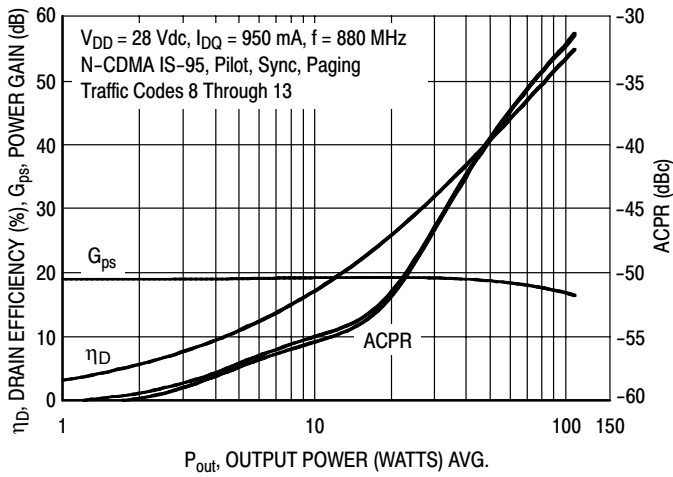
### TYPICAL CHARACTERISTICS



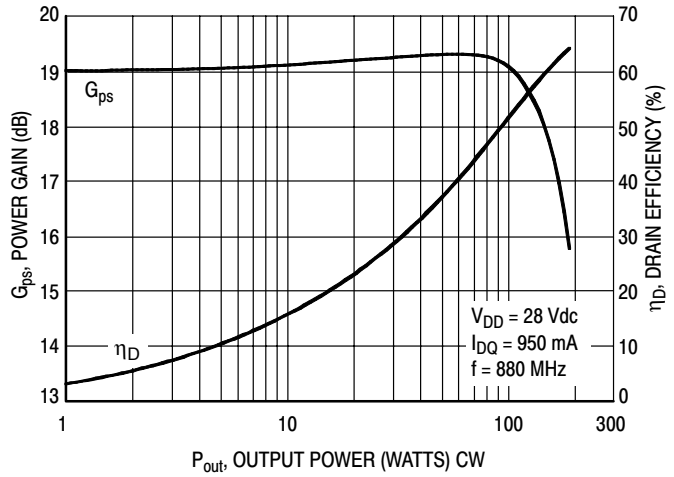
**Figure 7. Intermodulation Distortion Products versus Tone Spacing**



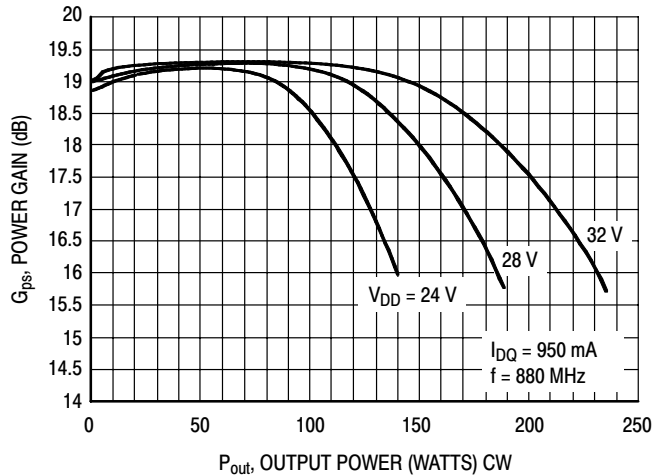
**Figure 8. Pulsed CW Output Power versus Input Power**



**Figure 9. Single-Carrier N-CDMA ACPR, Power Gain and Drain Efficiency versus Output Power**

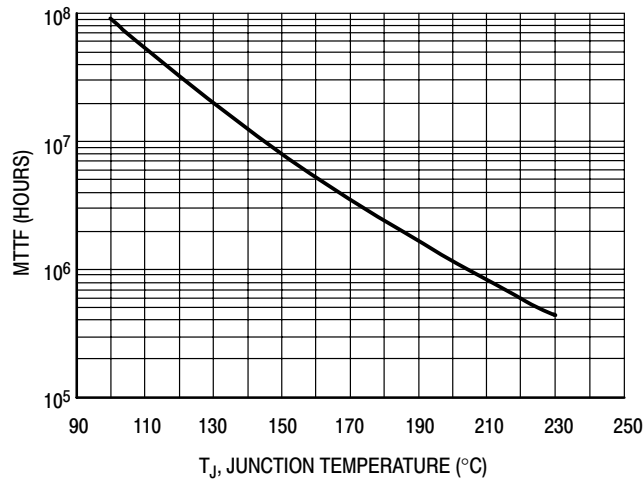


**Figure 10. Power Gain and Drain Efficiency versus CW Output Power**



**Figure 11. Power Gain versus Output Power**

## TYPICAL CHARACTERISTICS

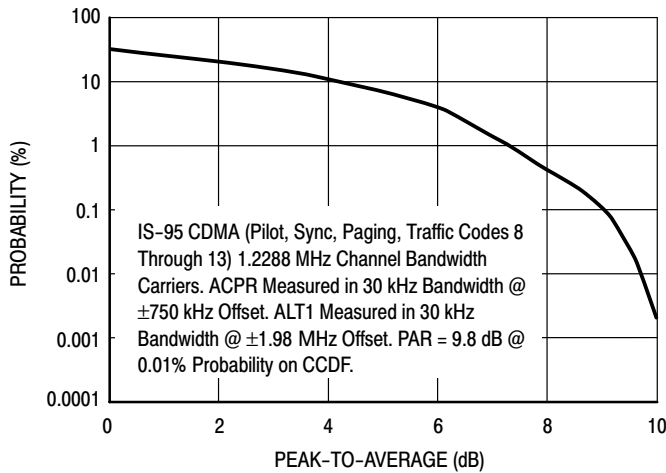


This above graph displays calculated MTTF in hours when the device is operated at  $V_{DD} = 28$  Vdc,  $P_{out} = 27$  W Avg., and  $\eta_D = 30.5\%$ .

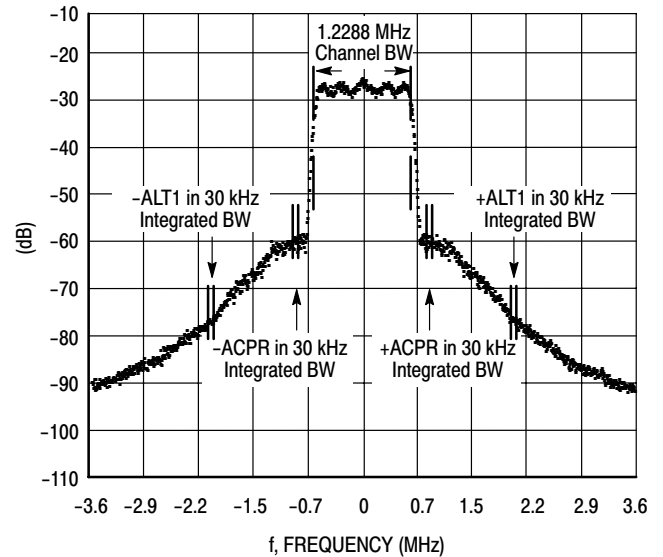
MTTF calculator available at <http://www.freescale.com/rf>. Select Software & Tools/Development Tools/Calculators to access MTTF calculators by product.

**Figure 12. MTTF versus Junction Temperature**

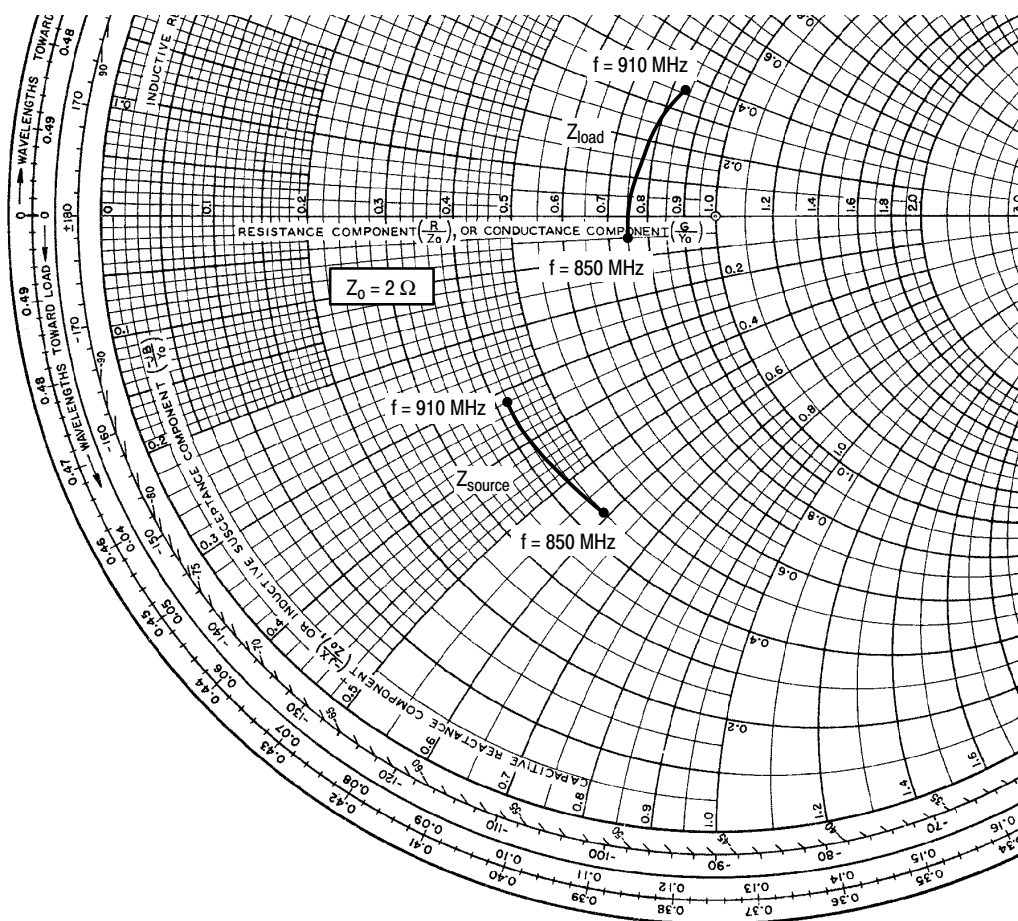
## N-CDMA TEST SIGNAL



**Figure 13. Single-Carrier CCDF N-CDMA**



**Figure 14. Single-Carrier N-CDMA Spectrum**



$V_{DD} = 28 \text{ Vdc}$ ,  $I_{DQ} = 950 \text{ mA}$ ,  $P_{out} = 27 \text{ W Avg.}$

f MHz	$Z_{source}$ $\Omega$	$Z_{load}$ $\Omega$
850	$0.89 - j1.18$	$1.50 - j0.09$
865	$0.87 - j1.03$	$1.52 + j0.11$
880	$0.85 - j0.89$	$1.55 + j0.31$
895	$0.83 - j0.75$	$1.60 + j0.51$
910	$0.84 - j0.64$	$1.68 + j0.71$

$Z_{source}$  = Test circuit impedance as measured from gate to ground.

$Z_{load}$  = Test circuit impedance as measured from drain to ground.

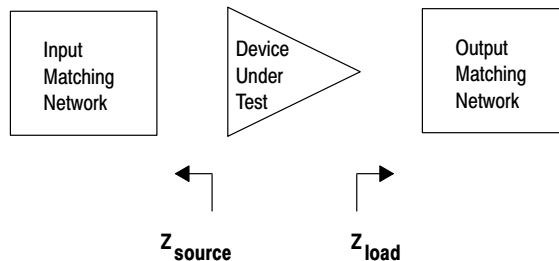
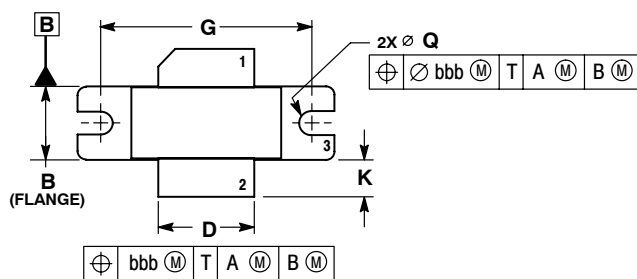


Figure 15. Series Equivalent Source and Load Impedance

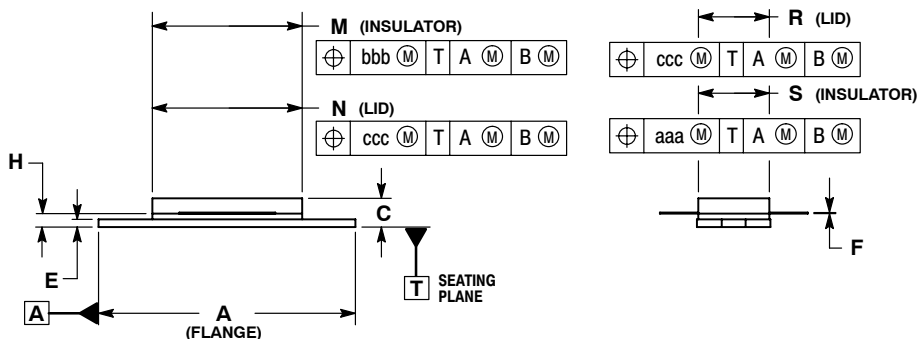


### PACKAGE DIMENSIONS



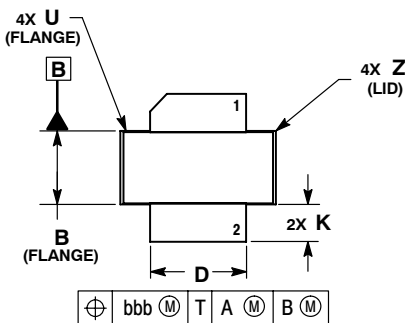
- NOTES:
1. DIMENSIONING AND TOLERANCING PER ANSI Y14.5M-1994.
  2. CONTROLLING DIMENSION: INCH.
  3. DELETED
  4. DIMENSION H IS MEASURED 0.030 (0.762) AWAY FROM PACKAGE BODY.

DIM	INCHES		MILLIMETERS	
	MIN	MAX	MIN	MAX
A	1.335	1.345	33.91	34.16
B	0.380	0.390	9.65	9.91
C	0.125	0.170	3.18	4.32
D	0.495	0.505	12.57	12.83
E	0.035	0.045	0.89	1.14
F	0.003	0.006	0.08	0.15
G	1.100 BSC		27.94 BSC	
H	0.057	0.067	1.45	1.70
K	0.170	0.210	4.32	5.33
M	0.774	0.786	19.66	19.96
N	0.772	0.788	19.60	20.00
Q	Ø.118	Ø.138	Ø.3.00	Ø.3.51
R	0.365	0.375	9.27	9.53
S	0.365	0.375	9.27	9.52
aaa	0.005 REF		0.127 REF	
bbb	0.010 REF		0.254 REF	
ccc	0.015 REF		0.381 REF	



- STYLE 1:  
 PIN 1. DRAIN  
 2. GATE  
 3. SOURCE

**CASE 465-06  
 ISSUE G  
 NI-780  
 MRF6S9130HR3**



- NOTES:
1. DIMENSIONING AND TOLERANCING PER ANSI Y14.5M-1994.
  2. CONTROLLING DIMENSION: INCH.
  3. DELETED
  4. DIMENSION H IS MEASURED 0.030 (0.762) AWAY FROM PACKAGE BODY.

DIM	INCHES		MILLIMETERS	
	MIN	MAX	MIN	MAX
A	0.805	0.815	20.45	20.70
B	0.380	0.390	9.65	9.91
C	0.125	0.170	3.18	4.32
D	0.495	0.505	12.57	12.83
E	0.035	0.045	0.89	1.14
F	0.003	0.006	0.08	0.15
H	0.057	0.067	1.45	1.70
K	0.170	0.210	4.32	5.33
M	0.774	0.786	19.61	20.02
N	0.772	0.788	19.61	20.02
R	0.365	0.375	9.27	9.53
S	0.365	0.375	9.27	9.52
U	---	0.040	---	1.02
Z	---	0.030	---	0.76
aaa	0.005 REF		0.127 REF	
bbb	0.010 REF		0.254 REF	
ccc	0.015 REF		0.381 REF	

- STYLE 1:  
 PIN 1. DRAIN  
 2. GATE  
 5. SOURCE

**CASE 465A-06  
 ISSUE H  
 NI-780S  
 MRF6S9130HSR3**

## PRODUCT DOCUMENTATION

Refer to the following documents to aid your design process.

### Application Notes

- AN1955: Thermal Measurement Methodology of RF Power Amplifiers

### Engineering Bulletins

- EB212: Using Data Sheet Impedances for RF LDMOS Devices

## REVISION HISTORY

The following table summarizes revisions to this document.

Revision	Date	Description
5	Aug. 2008	<ul style="list-style-type: none"> <li>• Listed replacement part and Device Migration notification reference number, p. 1</li> <li>• Removed Lower Thermal Resistance and Low Gold Plating bullets from Features section as functionality is standard, p. 1</li> <li>• Removed Total Device Dissipation from Max Ratings table as data was redundant (information already provided in Thermal Characteristics table), p. 1</li> <li>• Operating Junction Temperature increased from 200°C to 225°C in Maximum Ratings table and related “Continuous use of maximum temperature will affect MTTF” footnote added, p. 1</li> <li>• Corrected <math>V_{DS}</math> to <math>V_{DD}</math> in the RF test condition voltage callout for <math>V_{GS(Q)}</math>, and added “Measured in Functional Test”, On Characteristics table, p. 2</li> <li>• Removed Forward Transconductance from On Characteristics table as it no longer provided usable information, p. 2</li> <li>• Updated PCB information to show more specific material details, Fig. 1, Test Circuit Schematic, p. 3</li> <li>• Updated Part Numbers in Table 5, Component Designations and Values, to latest RoHS compliant part numbers, p. 3</li> <li>• Removed lower voltage tests from Fig. 11, Power Gain versus Output Power, due to fixed tuned fixture limitations, p. 6</li> <li>• Replaced Fig. 12, MTTF versus Junction Temperature with updated graph. Removed Amps<sup>2</sup> and listed operating characteristics and location of MTTF calculator for device, p. 7</li> <li>• Added Product Documentation and Revision History, p. 10</li> </ul>

ARCHIVE INFORMATION

ARCHIVE INFORMATION

**How to Reach Us:**

**Home Page:**

[www.freescale.com](http://www.freescale.com)

**Web Support:**

<http://www.freescale.com/support>

**USA/Europe or Locations Not Listed:**

Freescale Semiconductor, Inc.  
 Technical Information Center, EL516  
 2100 East Elliot Road  
 Tempe, Arizona 85284  
 1-800-521-6274 or +1-480-768-2130  
[www.freescale.com/support](http://www.freescale.com/support)

**Europe, Middle East, and Africa:**

Freescale Halbleiter Deutschland GmbH  
 Technical Information Center  
 Schatzbogen 7  
 81829 Muenchen, Germany  
 +44 1296 380 456 (English)  
 +46 8 52200080 (English)  
 +49 89 92103 559 (German)  
 +33 1 69 35 48 48 (French)  
[www.freescale.com/support](http://www.freescale.com/support)

**Japan:**

Freescale Semiconductor Japan Ltd.  
 Headquarters  
 ARCO Tower 15F  
 1-8-1, Shimo-Meguro, Meguro-ku,  
 Tokyo 153-0064  
 Japan  
 0120 191014 or +81 3 5437 9125  
[support.japan@freescale.com](mailto:support.japan@freescale.com)

**Asia/Pacific:**

Freescale Semiconductor China Ltd.  
 Exchange Building 23F  
 No. 118 Jianguo Road  
 Chaoyang District  
 Beijing 100022  
 China  
 +86 10 5879 8000  
[support.asia@freescale.com](mailto:support.asia@freescale.com)

**For Literature Requests Only:**

Freescale Semiconductor Literature Distribution Center  
 P.O. Box 5405  
 Denver, Colorado 80217  
 1-800-441-2447 or +1-303-675-2140  
 Fax: +1-303-675-2150  
[LDCForFreescaleSemiconductor@hibbertgroup.com](mailto:LDCForFreescaleSemiconductor@hibbertgroup.com)

Information in this document is provided solely to enable system and software implementers to use Freescale Semiconductor products. There are no express or implied copyright licenses granted hereunder to design or fabricate any integrated circuits or integrated circuits based on the information in this document.

Freescale Semiconductor reserves the right to make changes without further notice to any products herein. Freescale Semiconductor makes no warranty, representation or guarantee regarding the suitability of its products for any particular purpose, nor does Freescale Semiconductor assume any liability arising out of the application or use of any product or circuit, and specifically disclaims any and all liability, including without limitation consequential or incidental damages. "Typical" parameters that may be provided in Freescale Semiconductor data sheets and/or specifications can and do vary in different applications and actual performance may vary over time. All operating parameters, including "Typicals", must be validated for each customer application by customer's technical experts. Freescale Semiconductor does not convey any license under its patent rights nor the rights of others. Freescale Semiconductor products are not designed, intended, or authorized for use as components in systems intended for surgical implant into the body, or other applications intended to support or sustain life, or for any other application in which the failure of the Freescale Semiconductor product could create a situation where personal injury or death may occur. Should Buyer purchase or use Freescale Semiconductor products for any such unintended or unauthorized application, Buyer shall indemnify and hold Freescale Semiconductor and its officers, employees, subsidiaries, affiliates, and distributors harmless against all claims, costs, damages, and expenses, and reasonable attorney fees arising out of, directly or indirectly, any claim of personal injury or death associated with such unintended or unauthorized use, even if such claim alleges that Freescale Semiconductor was negligent regarding the design or manufacture of the part.

Freescale™ and the Freescale logo are trademarks of Freescale Semiconductor, Inc. All other product or service names are the property of their respective owners.

© Freescale Semiconductor, Inc. 2005-2006, 2008. All rights reserved.