

**DATA SHEET**

# SKY13395-397LF: 0.1 to 4.0 GHz DPDT Switch

## Applications

- Simultaneous voice and LTE data
- Diversity antenna switching

## Features

- Low insertion loss: 0.7 dB @ 2.5 GHz
- High isolation: 21 dB up to 2.5 GHz
- Positive control voltage range: 1.8 to 5.0 V
- IP1dB: +38 dBm typical @ 3 V
- Small, QFN (12-pin, 2 x 2 mm) package (MSL1, 260 °C per JEDEC J-STD-020)



Skyworks Green™ products are compliant with all applicable legislation and are halogen-free. For additional information, refer to *Skyworks Definition of Green™*, document number SQ04-0074.

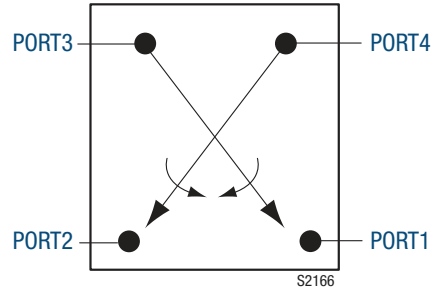

**Figure 1. SKY13395-397LF Block Diagram**

## Description

The SKY13395-397LF is a GaAs pHEMT double-pole, double-throw (DPDT) switch. The switch provides high linearity performance, low insertion loss, and high isolation.

Switching is controlled by two voltage inputs (CTRL1 and CTRL2). Depending on the logic voltage level applied to these pins, the PORT1 and PORT2 pins connect to one of the two other RF port pins (PORT3 or PORT4) through a low insertion loss path, while maintaining a high isolation path to the alternate port.

The SKY13395-397LF DPDT switch is provided in a compact Quad Flat No-Lead (QFN) 2 x 2 mm package. A functional block diagram is shown in Figure 1. The pin configuration and package are shown in Figure 2. Signal pin assignments and functional pin descriptions are provided in Table 1.

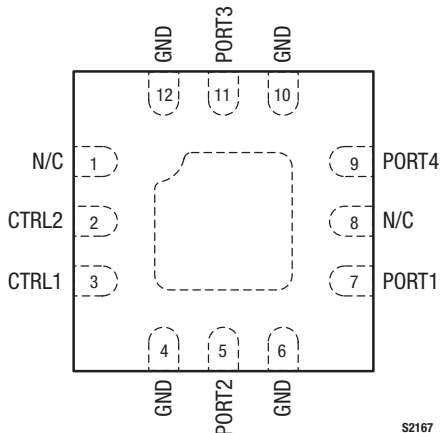

**Figure 2. SKY13395-397LF Pinout – 12-Pin QFN (Top View)**

**Table 1. SKY13395-397LF Signal Descriptions**

Pin #	Name	Description	Pin #	Name	Description
1	N/C	No connection. Pin may be grounded.	7	PORT1	RF port 1. Requires a DC blocking capacitor.
2	CTRL2	DC control voltage 2. See Table 4.	8	N/C	No connection. Pin may be grounded.
3	CTRL1	DC control voltage 1. See Table 4.	9	PORT4	RF Port 4. Requires a DC blocking capacitor.
4	GND	Ground. Internally grounded.	10	GND	Ground. Internally grounded.
5	PORT2	RF port 2. Requires a DC blocking capacitor.	11	PORT3	RF port 3. Requires a DC blocking capacitor.
6	GND	Ground. Internally grounded.	12	GND	Ground. Internally grounded.

**Note:** Exposed pad must be properly grounded using a low impedance path.

### Functional Description

The SKY13395-397LF DPDT switch can be used to connect either RF port 1 or RF port 2 to either RF port 3 or RF port 4 by applying the proper bias to the two control pins (CTRL1 and CTRL2). When Port 1 is connected to Port 4 using a low loss path, Port 2 is connected to Port 3 also with a low loss path. When Port 1 is connected to Port 3 using low loss path, Port 2 is connected to Port 4 also with a low loss path.

The DPDT switch is designed to maximize the isolation between ports to minimize coupling between RF paths.

### Electrical and Mechanical Specifications

The absolute maximum ratings of the SKY13395-397LF are provided in Table 2. Electrical specifications are provided in Table 3.

The state of the SKY13395-397LF is determined by the logic provided in Table 4.

Typical performance characteristics of the SKY13395-397LF are illustrated in Figures 3 through 7.

**Table 2. SKY13395-397LF Absolute Maximum Ratings (Note 1)**

Parameter	Symbol	Minimum	Maximum	Units
Control voltage	V <sub>CTL</sub>		6	V
Input power	P <sub>IN</sub>		+39	dBm
Storage temperature	T <sub>STG</sub>	-40	+125	°C
Operating temperature	T <sub>OP</sub>	-40	+85	°C

**Note 1:** Exposure to maximum rating conditions for extended periods may reduce device reliability. There is no damage to device with only one parameter set at the limit and all other parameters set at or below their nominal value. Exceeding any of the limits listed here may result in permanent damage to the device.

**CAUTION:** Although this device is designed to be as robust as possible, electrostatic discharge (ESD) can damage this device. This device must be protected at all times from ESD. Static charges may easily produce potentials of several kilovolts on the human body or equipment, which can discharge without detection. Industry-standard ESD precautions should be used at all times.

**Table 3. SKY13395-397LF Electrical Specifications (Note 1)**

( $V_{CTL} = 0\text{ V}$  and  $+3.0\text{ V}$ ,  $T_{OP} = +25\text{ }^{\circ}\text{C}$ ,  $P_{IN} = 0\text{ dBm}$ , Characteristic Impedance [ $Z_0$ ] =  $50\text{ }\Omega$ , Unless Otherwise Noted)

Parameter	Symbol	Test Condition	Min	Typical	Max	Units
<b>RF Specifications</b>						
Insertion loss	IL	PORT1/PORT2 to PORT3/PORT4				
		0.1 to 1.0 GHz		0.50	0.60	dB
		1.0 to 2.5 GHz		0.70	0.75	dB
		2.5 to 4.0 GHz		1.00	1.20	dB
Isolation	Iso	PORT1/PORT2 to PORT3/PORT4, PORT1 to PORT2, PORT3 to PORT4				
		0.1 to 1.0 GHz		27	28	dB
		1.0 to 2.5 GHz		19	21	dB
		2.5 to 4.0 GHz		15	17	dB
Return loss (Note 2)	IS11I	PORT1/PORT2 to PORT3/PORT4, 0.1 to 4.0 GHz		20		dB
1 dB input compression point	IP1dB	0.1 to 4.0 GHz		+38		dBm
0.1 dB input compression point	IP0.1dB	0.1 to 4.0 GHz		+35		dBm
Third order input intercept point	IIP3	$P_{IN} = +20\text{ dBm/}$ tone, $\Delta f = 1\text{ MHz}$ , 0.1 to 4.0 GHz		+62		dBm
2 <sup>nd</sup> harmonic	2fo	$P_{IN} = +25\text{ dBm}$ , 0.1 to 4.0 GHz		+77		dBc
3 <sup>rd</sup> harmonic	3fo	$P_{IN} = +25\text{ dBm}$ , 0.1 to 4.0 GHz		+77		dBc
Error vector magnitude	EVM	@ 2.45 GHz, $P_{IN}$ level @ 2.5% EVM, 802.11g, 54 Mbps, 64 QAM, $V_{CTL} = 3\text{ V}$		+30		dBm
Switching speed		50% V1/V2 to 90/10% RF		50		ns
		90/10% RF or 10/90% RF		35		ns
<b>DC Specifications</b>						
Control voltage: high low	V1, V2		1.8	3.0	5.0	V
			-0.2	0	+0.2	V
Control current	I <sub>cc</sub>			5		$\mu\text{A}$

**Note 1:** Performance is guaranteed only under the conditions listed in this table.

**Note 2:** Lower frequency return loss is dependent on the DC blocking capacitor value.

**Table 4. SKY13395-397LF Truth Table**

CTRL1	CTRL2	State
0	0	Low current mode (PORT1/2/3/4 connected)
1	0	PORT3 to PORT1, PORT4 to PORT2
0	1	PORT3 to PORT2, PORT4 to PORT1

**Note:** 1 = 1.8 to 5.0 V

0 = -0.2 to +0.2 V

Any state other than described in this Table places the switch into an undefined state.

### Typical Performance Characteristics

( $V_{CTL} = 0\text{ V}$  and  $+3.0\text{ V}$ ,  $T_{OP} = +25\text{ }^{\circ}\text{C}$ ,  $P_{IN} = 0\text{ dBm}$ , Characteristic Impedance [ $Z_0$ ] =  $50\text{ }\Omega$ , Unless Otherwise Noted)

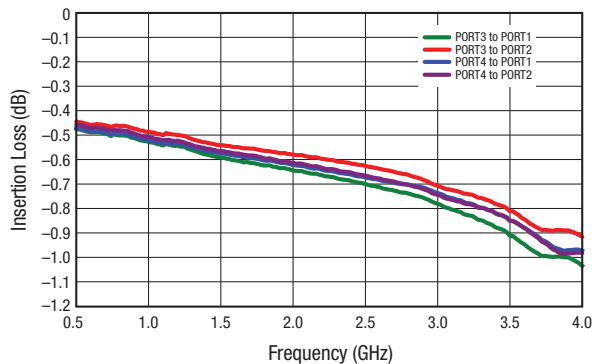

Figure 3. Insertion Loss vs Frequency

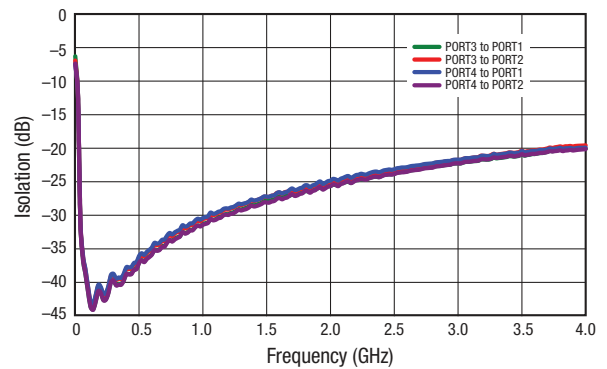

Figure 4. Isolation vs Frequency

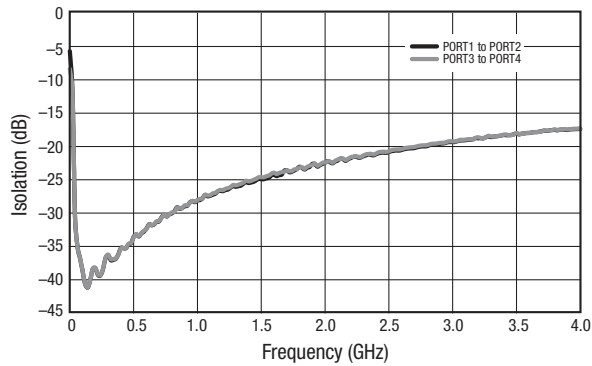

Figure 5. Isolation vs Frequency

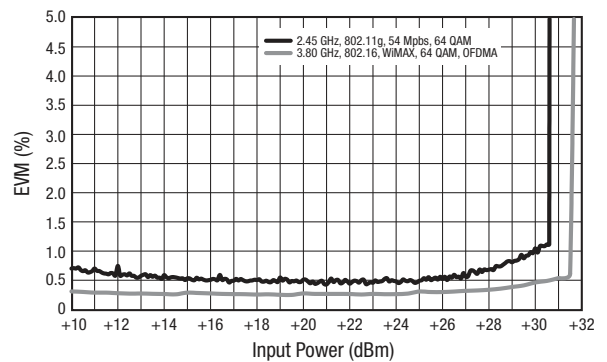

Figure 6. EVM vs Input Power

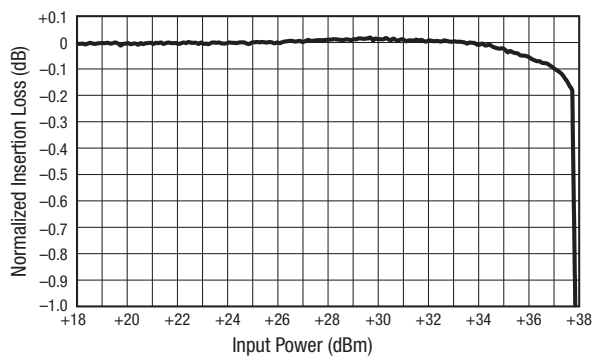

Figure 7. Normalized Insertion Loss vs Input Power @ 2.5 GHz

### Evaluation Board Description

The SKY13395-397LF Evaluation Board is used to test the performance of the SKY13395-397LF DPDT Switch.

An Evaluation Board schematic diagram is provided in Figure 8. An assembly drawing for the Evaluation Board is shown in Figure 9.

### Package Dimensions

The PCB layout footprint for the SKY13395-397LF is provided in Figure 10. Typical part markings are shown in Figure 11. Package dimensions for the 12-pin QFN are shown in Figure 12, and tape and reel dimensions are provided in Figure 13.

### Package and Handling Information

Instructions on the shipping container label regarding exposure to moisture after the container seal is broken must be followed. Otherwise, problems related to moisture absorption may occur when the part is subjected to high temperature during solder assembly.

The SKY13395-397LF is rated to Moisture Sensitivity Level 1 (MSL1) at 260 °C. It can be used for lead or lead-free soldering. For additional information, refer to the Skyworks Application Note, *Solder Reflow Information*, document number 200164.

Care must be taken when attaching this product, whether it is done manually or in a production solder reflow environment. Production quantities of this product are shipped in a standard tape and reel format.

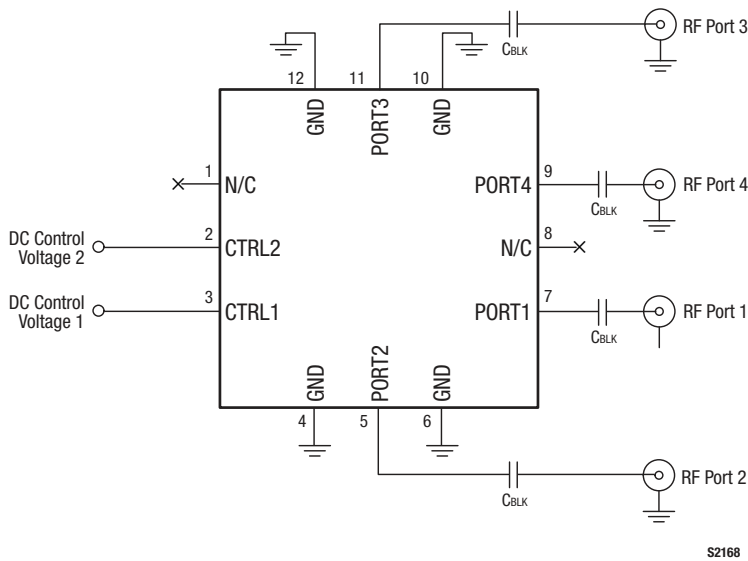

Figure 8. SKY13395-397LF Evaluation Board Schematic

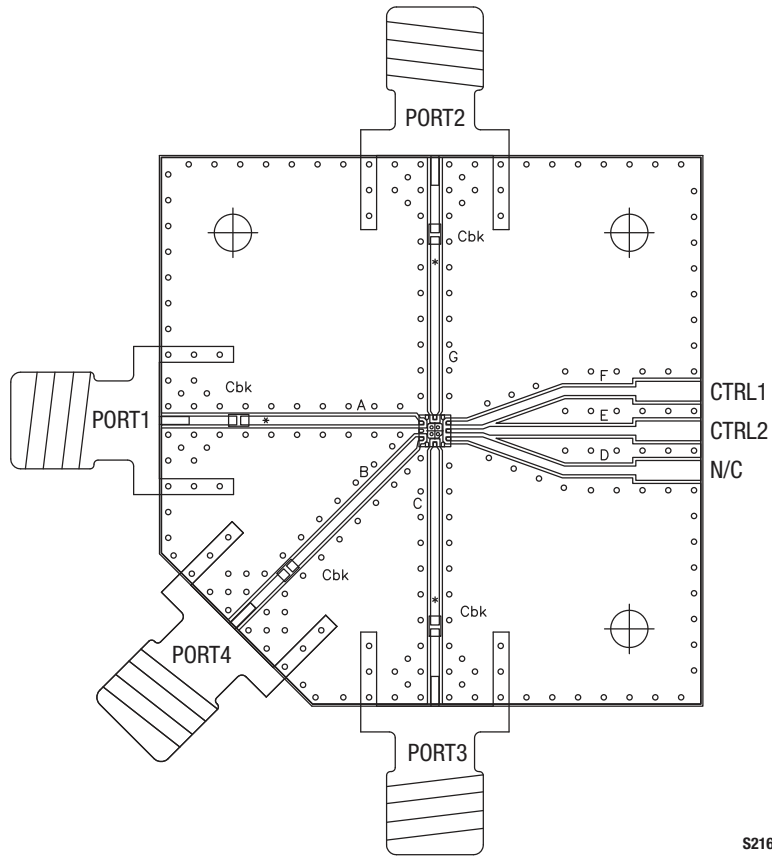

Figure 9. SKY13395-397LF Evaluation Board Assembly Diagram

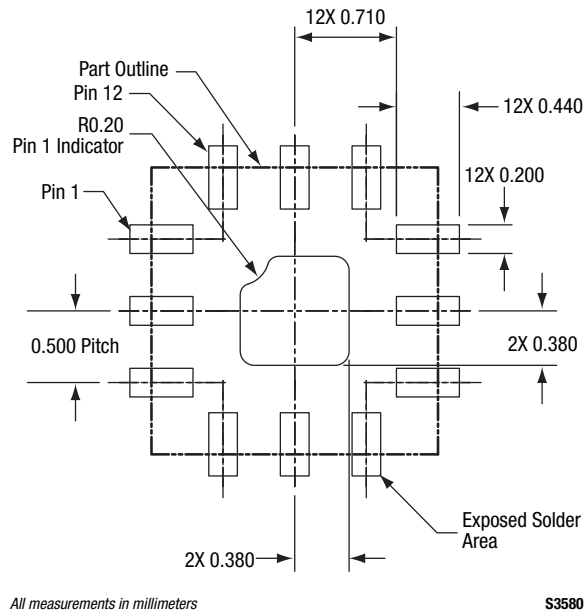
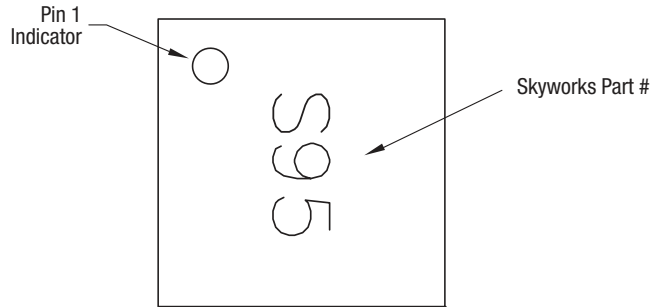
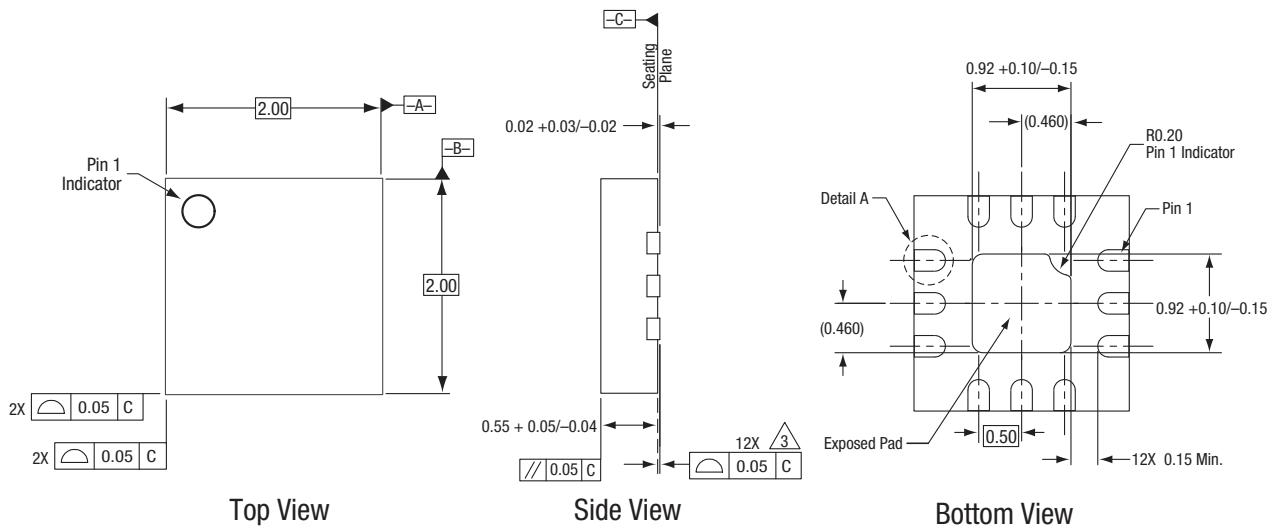

Figure 10. SKY13395-397LF PCB Layout Footprint (Top View)

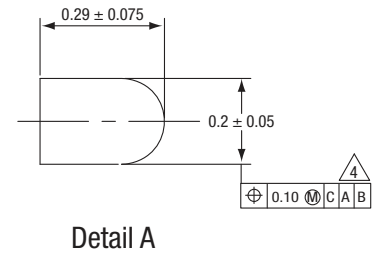

**Figure 11. Typical Part Markings (Top View)**



**Notes:**

1. All measurements are in millimeters.
2. Dimensions and tolerances according to ASME Y14.5M-1994.
3. Coplanarity applies to the terminals and all other bottom surface metallization.
4. Dimension applies to metallized terminal. If the terminal has a radius on its end, the width dimension should not be measured in that radius area.



S1985

**Figure 12. SKY13395-397LF Package Dimensions**

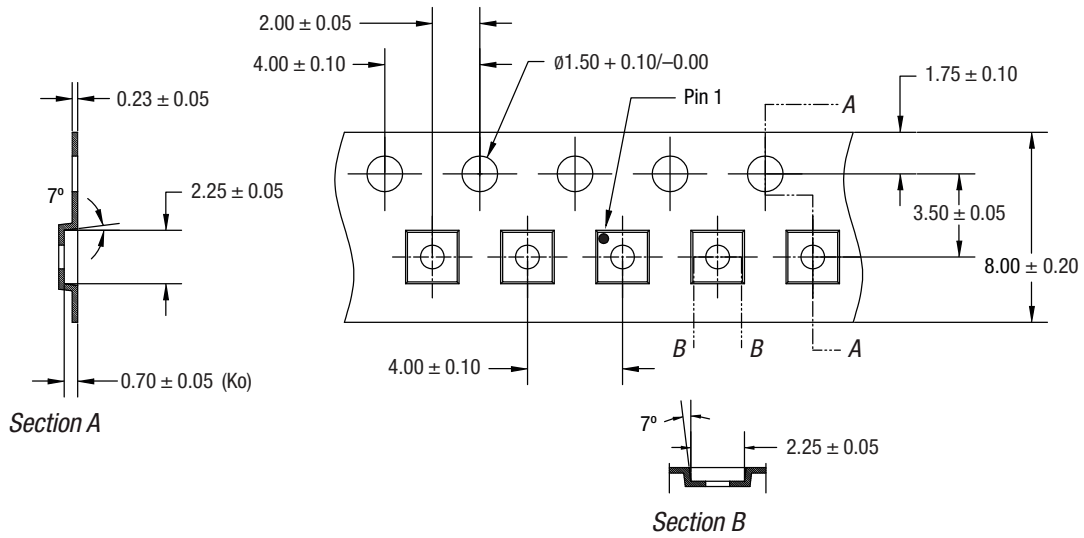

Notes:

1. Carrier tape must meet all requirements of Skyworks GP01-D232 procurement spec for tape and reel shipping.
2. Carrier tape shall be black conductive polycarbonate bakeable material at 125 °C temperature.
3. Cover tape shall be transparent conductive with 5.40 mm width.
4. ESD-surface resistivity must meet all ESD requirements of Skyworks specified on GP01-D232.
5. All measurements are in millimeters.

ts737

**Figure 13. SKY13395-397LF Tape and Reel Dimensions**



## Ordering Information

Model Name	Manufacturing Part Number	Evaluation Board Part Number
SKY13395-397LF DPDT Switch	SKY13395-397LF	SKY13395-397LF-EVB

Copyright © 2011, 2013-2015 Skyworks Solutions, Inc. All Rights Reserved.

Information in this document is provided in connection with Skyworks Solutions, Inc. ("Skyworks") products or services. These materials, including the information contained herein, are provided by Skyworks as a service to its customers and may be used for informational purposes only by the customer. Skyworks assumes no responsibility for errors or omissions in these materials or the information contained herein. Skyworks may change its documentation, products, services, specifications or product descriptions at any time, without notice. Skyworks makes no commitment to update the materials or information and shall have no responsibility whatsoever for conflicts, incompatibilities, or other difficulties arising from any future changes.

No license, whether express, implied, by estoppel or otherwise, is granted to any intellectual property rights by this document. Skyworks assumes no liability for any materials, products or information provided hereunder, including the sale, distribution, reproduction or use of Skyworks products, information or materials, except as may be provided in Skyworks Terms and Conditions of Sale.

THE MATERIALS, PRODUCTS AND INFORMATION ARE PROVIDED "AS IS" WITHOUT WARRANTY OF ANY KIND, WHETHER EXPRESS, IMPLIED, STATUTORY, OR OTHERWISE, INCLUDING FITNESS FOR A PARTICULAR PURPOSE OR USE, MERCHANTABILITY, PERFORMANCE, QUALITY OR NON-INFRINGEMENT OF ANY INTELLECTUAL PROPERTY RIGHT; ALL SUCH WARRANTIES ARE HEREBY EXPRESSLY DISCLAIMED. SKYWORKS DOES NOT WARRANT THE ACCURACY OR COMPLETENESS OF THE INFORMATION, TEXT, GRAPHICS OR OTHER ITEMS CONTAINED WITHIN THESE MATERIALS. SKYWORKS SHALL NOT BE LIABLE FOR ANY DAMAGES, INCLUDING BUT NOT LIMITED TO ANY SPECIAL, INDIRECT, INCIDENTAL, STATUTORY, OR CONSEQUENTIAL DAMAGES, INCLUDING WITHOUT LIMITATION, LOST REVENUES OR LOST PROFITS THAT MAY RESULT FROM THE USE OF THE MATERIALS OR INFORMATION, WHETHER OR NOT THE RECIPIENT OF MATERIALS HAS BEEN ADVISED OF THE POSSIBILITY OF SUCH DAMAGE.

Skyworks products are not intended for use in medical, lifesaving or life-sustaining applications, or other equipment in which the failure of the Skyworks products could lead to personal injury, death, physical or environmental damage. Skyworks customers using or selling Skyworks products for use in such applications do so at their own risk and agree to fully indemnify Skyworks for any damages resulting from such improper use or sale.

Customers are responsible for their products and applications using Skyworks products, which may deviate from published specifications as a result of design defects, errors, or operation of products outside of published parameters or design specifications. Customers should include design and operating safeguards to minimize these and other risks. Skyworks assumes no liability for applications assistance, customer product design, or damage to any equipment resulting from the use of Skyworks products outside of stated published specifications or parameters.

Skyworks and the Skyworks symbol are trademarks or registered trademarks of Skyworks Solutions, Inc., in the United States and other countries. Third-party brands and names are for identification purposes only, and are the property of their respective owners. Additional information, including relevant terms and conditions, posted at [www.skyworksinc.com](http://www.skyworksinc.com), are incorporated by reference.