



Micro Commercial Components



Micro Commercial Components
20736 Marilla Street Chatsworth
CA 91311
Phone: (818) 701-4933
Fax: (818) 701-4939

**2SD667(A)-B
2SD667(A)-C
2SD667(A)-D**

Features

- Epoxy meets UL 94 V-0 flammability rating
- Moisture Sensitivity Level 1
- Capable of 0.9Watts of Power Dissipation.
- Collector-current 1.0A
- Collector-base Voltage 120V
- Operating and storage junction temperature range: -55°C to +150°C
- Halogen free available upon request by adding suffix "-HF"
- Lead Free Finish/Rohs Compliant ("P" Suffix designates RoHS Compliant. See ordering information)

Electrical Characteristics @ 25°C Unless Otherwise Specified

Symbol	Parameter	Min	Max	Units
--------	-----------	-----	-----	-------

OFF CHARACTERISTICS

$V_{(BR)CEO}$	2SD667	Collector-Emitter Breakdown Voltage ($I_C = 1mA_{dc}, I_B = 0$)	80		Vdc
	2SD667A		100		Vdc
$V_{(BR)CBO}$		Collector-Base Breakdown Voltage ($I_C = 10\mu A_{dc}, I_E = 0$)	120		Vdc
$V_{(BR)EBO}$		Emitter-Base Voltage ($I_E = 10\mu A_{dc}, I_C = 0$)	5		Vdc
I_{CBO}		Collector Cutoff Current ($V_{CB} = 100V_{dc}, I_E = 0$)		10	μA_{dc}

ON CHARACTERISTICS

h_{FE}	DC Current Gain ($I_C = 150mA_{dc}, V_{CE} = 5V_{dc}$)	60	320		
$V_{CE(sat)}$	Collector-Emitter Saturation Voltage ($I_C = 500mA_{dc}, I_B = 50mA_{dc}$)		1		Vdc

SMALL-SIGNAL CHARACTERISTICS

f_T	Transistor Frequency ($I_C = 150mA_{dc}, V_{CE} = 5V_{dc}$)	140(type)			MHz
C_{ob}	Output capacitance ($I_E = 0, V_{CE} = 10V_{dc}, f = 1MHz$)	20(type)			pF

CLASSIFICATION OF h_{FE} (1)

Rank	B	C	D
Range	60-120	100-200	160-320

**NPN Silicon
Plastic-Encapsulate
Transistor**

TO-92MOD

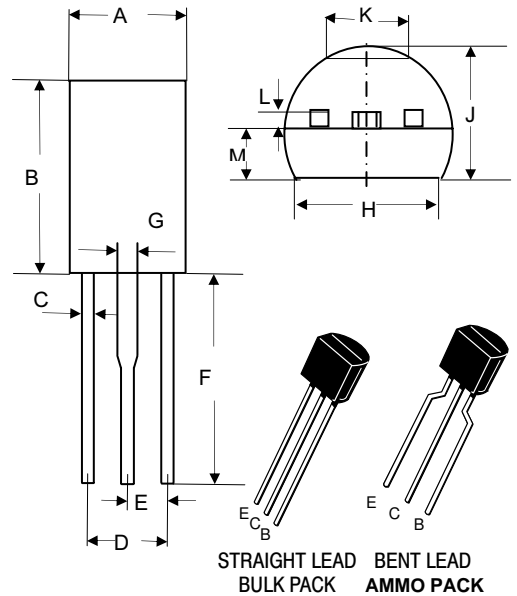

DIM	INCHES		MM		NOTE
	MIN	MAX	MIN	MAX	
A	.228	.244	5.80	6.20	
B	.331	.346	8.40	8.80	
C	.016	.024	0.40	0.60	
D	.114	.122	2.90	3.10	Straight Lead
	.173	.220	4.40	5.60	Bent Lead
E	.059		1.50		Straight Lead
	.086	.110	2.20	2.80	Bent Lead
F	.543	.559	13.80	14.20	
G	.035	.043	0.90	1.10	
H	.157	----	4.00	---	
J	.185	.201	4.70	5.10	
K	----	.063	----	1.60	
L	.016	.020	0.40	0.50	
M	.068	.080	1.73	2.03	

For ammo packing detailed specification, click here to visit our website of product packaging for details.

2SD667(A)

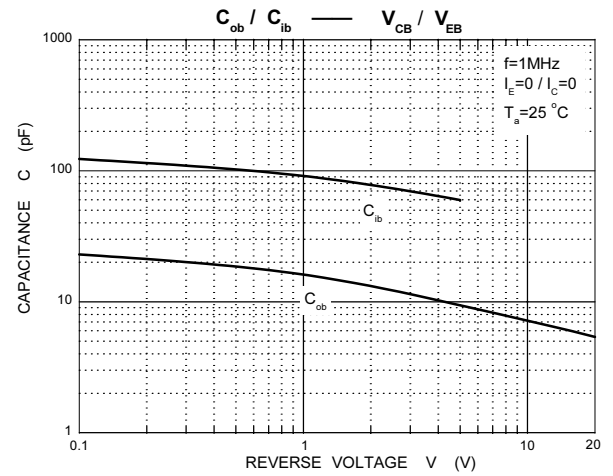
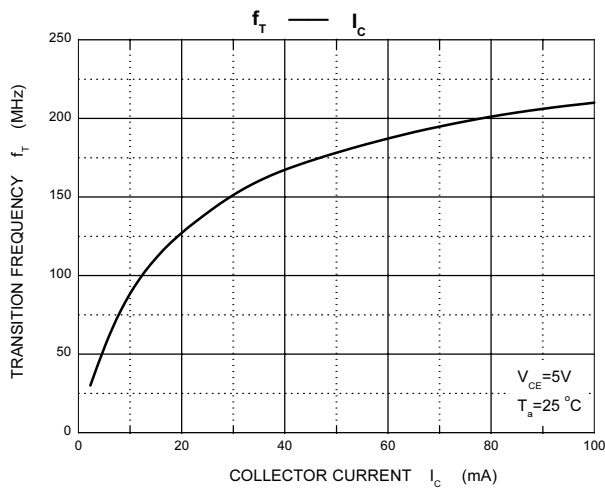
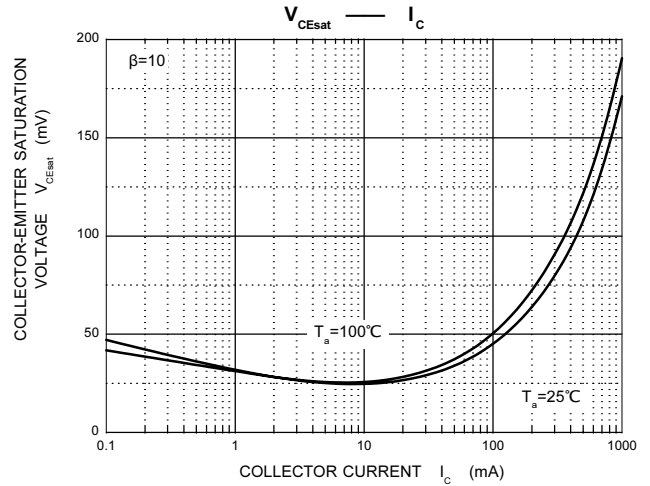
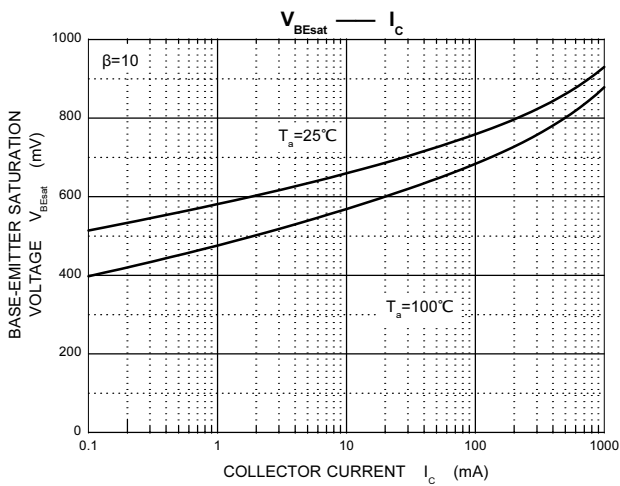
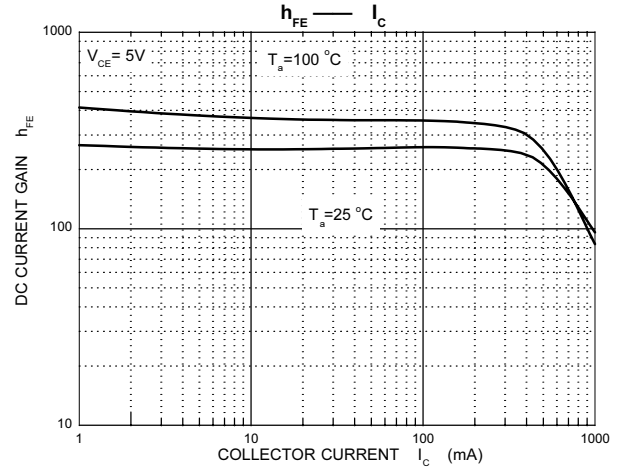
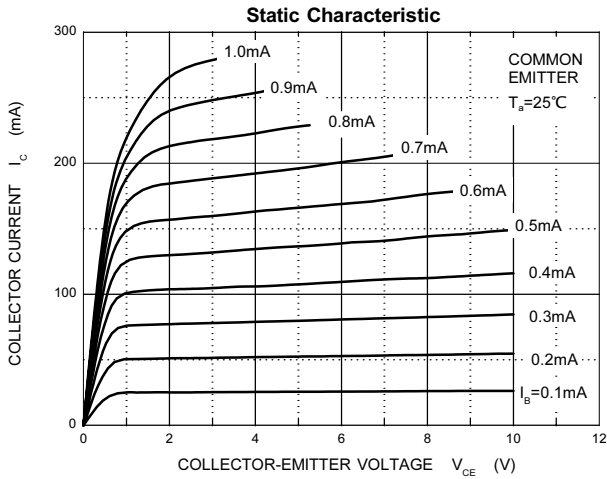

2SD667(A)

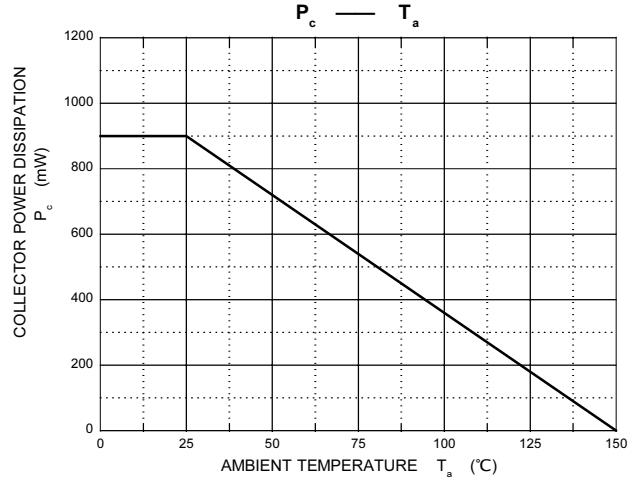
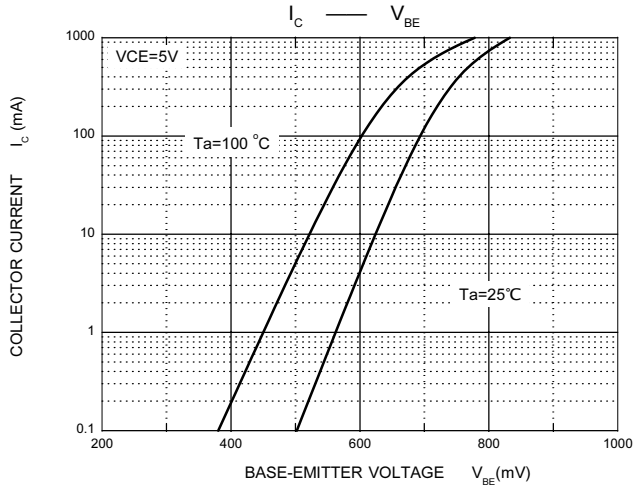



TM

Micro Commercial Components

Ordering Information :

Device	Packing
Part Number-AP	Ammo Packing: 20Kpcs/Carton
Part Number-BP	Bulk: 50Kpcs/Carton

Note : Adding "-HF" suffix for halogen free, eg. Part Number-AP-HF

IMPORTANT NOTICE

Micro Commercial Components Corp. reserves the right to make changes without further notice to any product herein to make corrections, modifications, enhancements, improvements, or other changes. **Micro Commercial Components Corp.** does not assume any liability arising out of the application or use of any product described herein; neither does it convey any license under its patent rights, nor the rights of others. The user of products in such applications shall assume all risks of such use and will agree to hold **Micro Commercial Components Corp.** and all the companies whose products are represented on our website, harmless against all damages.

LIFE SUPPORT

MCC's products are not authorized for use as critical components in life support devices or systems without the express written approval of Micro Commercial Components Corporation.

CUSTOMER AWARENESS

Counterfeiting of semiconductor parts is a growing problem in the industry. Micro Commercial Components (MCC) is taking strong measures to protect ourselves and our customers from the proliferation of counterfeit parts. MCC strongly encourages customers to purchase MCC parts either directly from MCC or from Authorized MCC Distributors who are listed by country on our web page cited below. Products customers buy either from MCC directly or from Authorized MCC Distributors are genuine parts, have full traceability, meet MCC's quality standards for handling and storage. **MCC will not provide any warranty coverage or other assistance for parts bought from Unauthorized Sources.** MCC is committed to combat this global problem and encourage our customers to do their part in stopping this practice by buying direct or from authorized distributors.

www.mccsemi.com