

General Description

- Latest Alpha IGBT (α IGBT) technology
- Best in Class $V_{CE(sat)}$ enables high efficiencies
- Low turn-off switching loss due to fast turn-off time
- Very smooth turn-off current waveforms reduce EMI
- Better thermal management
- High surge current capability
- Minimal gate spike due to high input capacitance

Applications

- Induction Cooking
- Rice Cookers
- Microwave Ovens
- Other soft switching applications

Product Summary

V_{CE}	1200V
I_C ($T_C=100^\circ\text{C}$)	20A
$V_{CE(sat)}$ ($T_C=25^\circ\text{C}$)	1.75V



Top View
TO-247

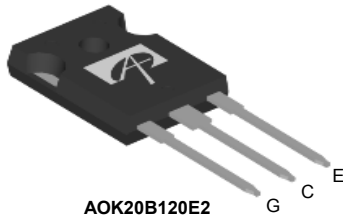

AOK20B120E2

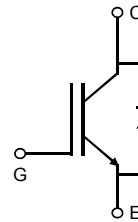

Orderable Part Number	Package Type	Form	Minimum Order Quantity
AOK20B120E2	TO247	Tube	240
Absolute Maximum Ratings $T_A=25^\circ\text{C}$ unless otherwise noted			
Parameter	Symbol	AOK20B120E2	Units
Collector-Emitter Voltage	V_{CE}	1200	V
Gate-Emitter Voltage	V_{GE}	± 30	V
Continuous Collector Current	I_C	$T_C=25^\circ\text{C}$	40
		$T_C=100^\circ\text{C}$	20
Pulsed Collector Current, Limited by T_{Jmax}	I_{Cpulse}	80	A
Non repetitive peak collector current ^A	I_{CSM}	200	A
Turn off SOA, $V_{CE} \leq 600\text{V}$, Limited by T_{Jmax}	I_{LM}	80	A
Continuous Diode Forward Current	I_F	$T_C=25^\circ\text{C}$	40
		$T_C=100^\circ\text{C}$	20
Diode Pulsed Current, Limited by T_{Jmax}	I_{Fpulse}	80	A
Power Dissipation	P_D	$T_C=25^\circ\text{C}$	250
		$T_C=100^\circ\text{C}$	125
Junction and Storage Temperature Range	T_J, T_{STG}	-55 to 175	$^\circ\text{C}$
Maximum lead temperature for soldering purpose, 1/8" from case for 5 seconds	T_L	300	$^\circ\text{C}$
Thermal Characteristics			
Parameter	Symbol	AOK20B120E2	Units
Maximum Junction-to-Ambient	$R_{\theta JA}$	40	$^\circ\text{C/W}$
Maximum IGBT Junction-to-Case	$R_{\theta JC}$	0.6	$^\circ\text{C/W}$
Maximum Diode Junction-to-Case	$R_{\theta JC}$	1.6	$^\circ\text{C/W}$

Note A: Capacitor charging saturation current limited by $T_{Jmax} < 175^\circ\text{C}$ and $t_p < 3\mu\text{s}$

Electrical Characteristics (T_J=25°C unless otherwise noted)

Symbol	Parameter	Conditions	Min	Typ	Max	Units	
STATIC PARAMETERS							
V_{CES}	Collector-Emitter Breakdown Voltage	$I_C=1mA, V_{GE}=0V, T_J=25^\circ C$	1200	-	-	V	
$V_{CE(sat)}$	Collector-Emitter Saturation Voltage	$V_{GE}=15V, I_C=20A$	$T_J=25^\circ C$	-	1.75	2.2	V
			$T_J=125^\circ C$	-	2.2	-	
			$T_J=175^\circ C$	-	2.3	-	
V_F	Diode Forward Voltage	$V_{GE}=0V, I_C=20A$	$T_J=25^\circ C$	-	1.6	2	V
			$T_J=125^\circ C$	-	2.3	-	
			$T_J=175^\circ C$	-	2.4	-	
$V_{GE(th)}$	Gate-Emitter Threshold Voltage	$V_{CE}=5V, I_C=1mA$	4.4	5.05	5.7	V	
I_{CES}	Zero Gate Voltage Collector Current	$V_{CE}=1200V, V_{GE}=0V$	$T_J=25^\circ C$	-	-	10	μA
			$T_J=125^\circ C$	-	-	500	
			$T_J=175^\circ C$	-	-	5000	
I_{GES}	Gate-Emitter leakage current	$V_{CE}=0V, V_{GE}=\pm 30V$	-	-	± 100	nA	
g_{FS}	Forward Transconductance	$V_{CE}=20V, I_C=20A$	-	22.5	-	S	
DYNAMIC PARAMETERS							
C_{ies}	Input Capacitance	$V_{GE}=0V, V_{CE}=25V, f=1MHz$	-	1445	-	pF	
C_{oes}	Output Capacitance		-	85	-	pF	
C_{res}	Reverse Transfer Capacitance		-	25	-	pF	
Q_g	Total Gate Charge	$V_{GE}=15V, V_{CE}=960V, I_C=20A$	-	53.5	-	nC	
Q_{ge}	Gate to Emitter Charge		-	12	-	nC	
Q_{gc}	Gate to Collector Charge		-	24.5	-	nC	
R_g	Gate resistance	$V_{GE}=0V, V_{CE}=0V, f=1MHz$	-	2.2	-	Ω	
SWITCHING PARAMETERS, (Load Inductive, T_J=25°C)							
$t_{D(off)}$	Turn-Off Delay Time	$T_J=25^\circ C$	-	123	-	ns	
t_f	Turn-Off Fall Time	$V_{GE}=15V, V_{CE}=600V, I_C=20A,$ $R_G=15\Omega,$	-	120	-	ns	
E_{off}	Turn-Off Energy	Parasitic Inductance=150nH	-	0.82	-	mJ	
SWITCHING PARAMETERS, (Load Inductive, T_J=175°C)							
$t_{D(off)}$	Turn-Off Delay Time	$T_J=175^\circ C$	-	144	-	ns	
t_f	Turn-Off Fall Time	$V_{GE}=15V, V_{CE}=600V, I_C=20A,$ $R_G=15\Omega,$	-	170	-	ns	
E_{off}	Turn-Off Energy	Parasitic Inductance=150nH	-	1.32	-	mJ	

THIS PRODUCT HAS BEEN DESIGNED AND QUALIFIED FOR THE CONSUMER MARKET. APPLICATIONS OR USES AS CRITICAL COMPONENTS IN LIFE SUPPORT DEVICES OR SYSTEMS ARE NOT AUTHORIZED. AOS DOES NOT ASSUME ANY LIABILITY ARISING OUT OF SUCH APPLICATIONS OR USES OF ITS PRODUCTS. AOS RESERVES THE RIGHT TO IMPROVE PRODUCT DESIGN, FUNCTIONS AND RELIABILITY WITHOUT NOTICE.

TYPICAL ELECTRICAL AND THERMAL CHARACTERISTICS

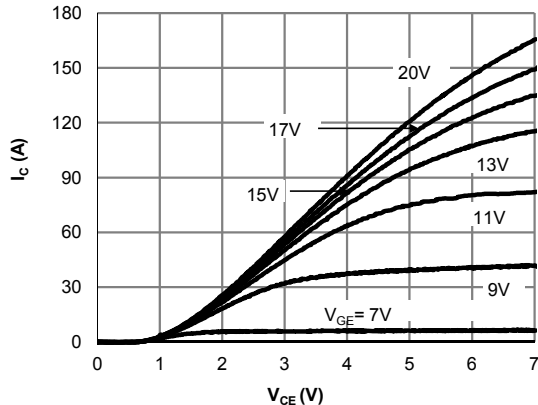

Figure 1: Output Characteristic
($T_j=25^\circ\text{C}$)

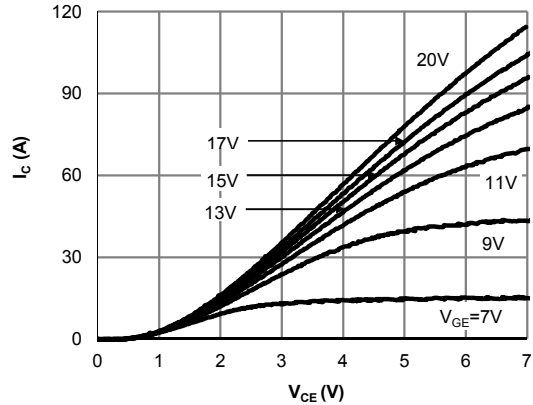

Figure 2: Output Characteristic
($T_j=175^\circ\text{C}$)

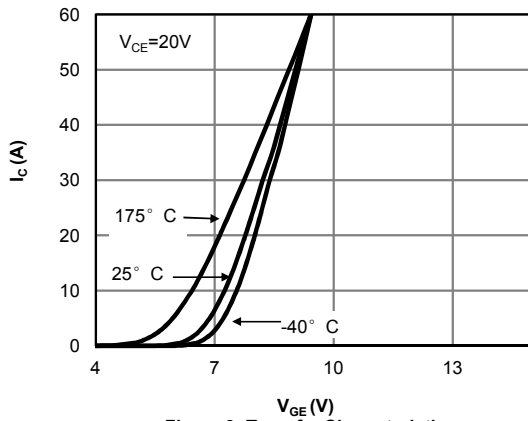

Figure 3: Transfer Characteristic

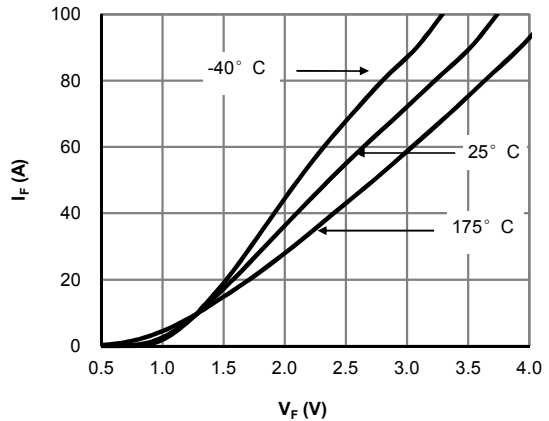

Figure 4: Diode Characteristic

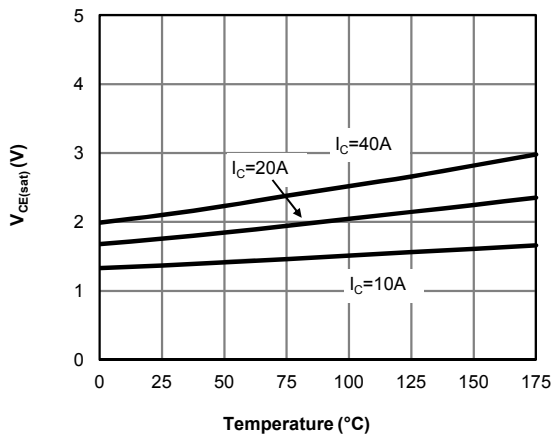

Figure 5: Collector-Emitter Saturation Voltage vs. Junction Temperature

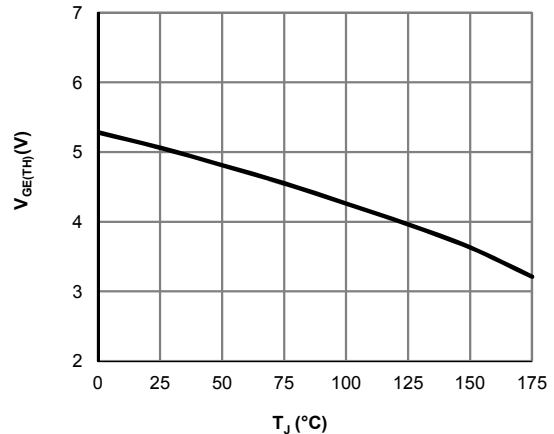

Figure 6: $V_{GE(TH)}$ vs. T_j

TYPICAL ELECTRICAL AND THERMAL CHARACTERISTICS

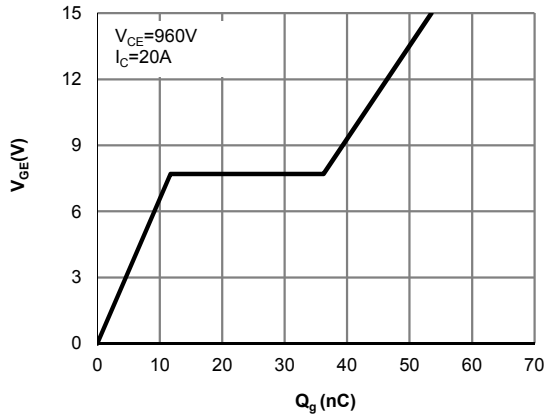

Figure 7: Gate-Charge Characteristics

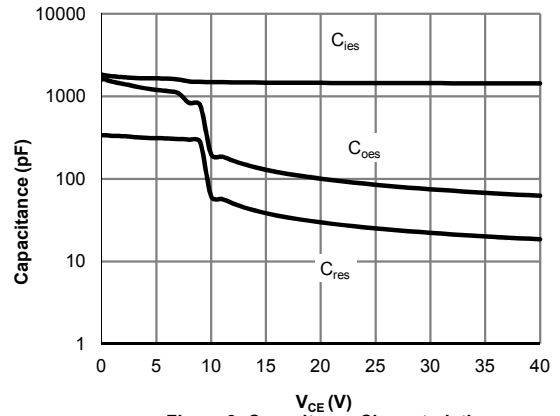

Figure 8: Capacitance Characteristic

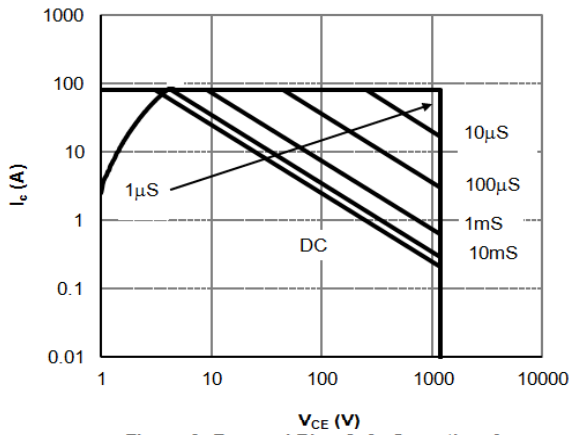

Figure 9: Forward Bias Safe Operating Area
($T_C=25^\circ\text{C}$, $V_{GE}=15\text{V}$)

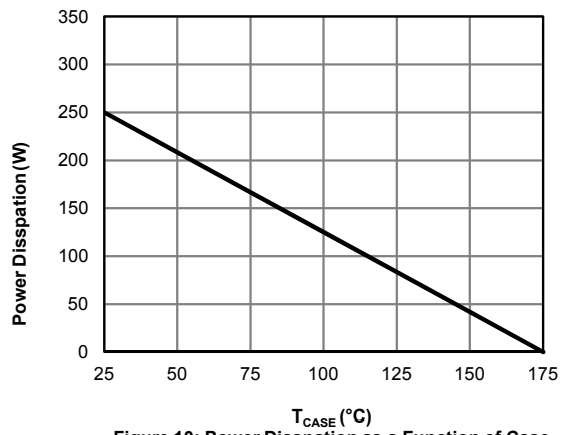

Figure 10: Power Dissipation as a Function of Case

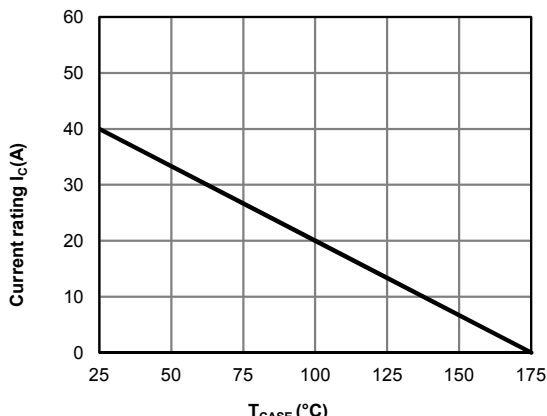

Figure 11: Current De-rating

TYPICAL ELECTRICAL AND THERMAL CHARACTERISTICS

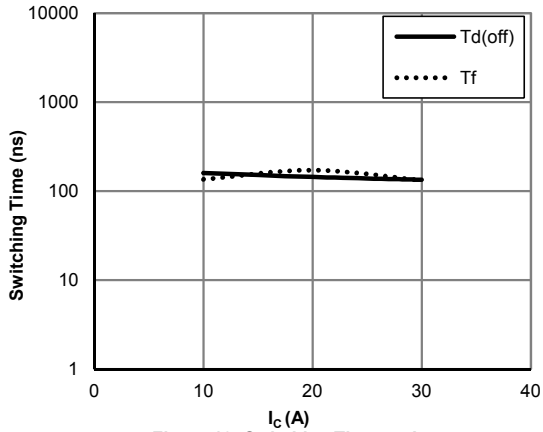

Figure 12: Switching Time vs. I_c
($T_j=175^\circ\text{C}$, $V_{GE}=15\text{V}$, $V_{CE}=600\text{V}$, $R_g=15\Omega$)

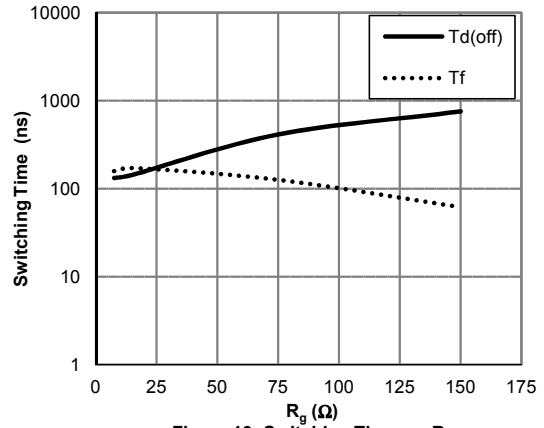

Figure 13: Switching Time vs. R_g
($T_j=175^\circ\text{C}$, $V_{GE}=15\text{V}$, $V_{CE}=600\text{V}$, $I_c=20\text{A}$)

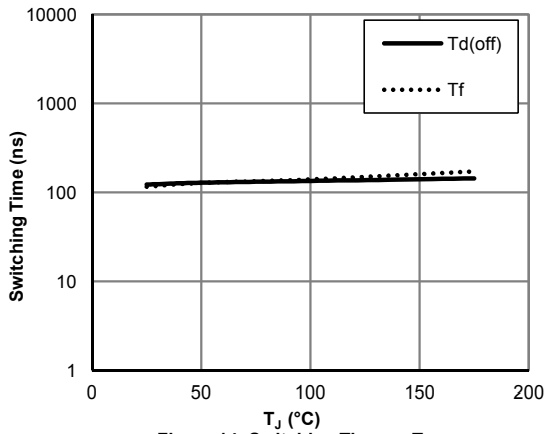

Figure 14: Switching Time vs. T_j
($V_{GE}=15\text{V}$, $V_{CE}=600\text{V}$, $I_c=20\text{A}$, $R_g=15\Omega$)

TYPICAL ELECTRICAL AND THERMAL CHARACTERISTICS

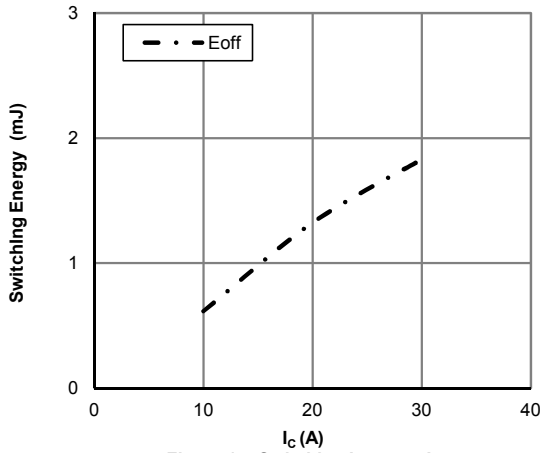

Figure 15: Switching Loss vs. I_C
($T_J=175^\circ\text{C}$, $V_{GE}=15\text{V}$, $V_{CE}=600\text{V}$, $R_g=15\Omega$)

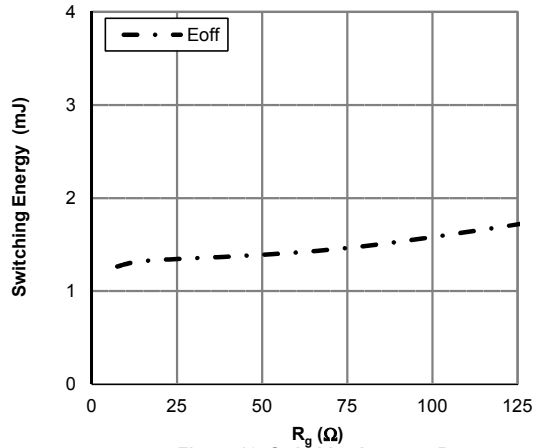

Figure 16: Switching Loss vs. R_g
($T_J=175^\circ\text{C}$, $V_{GE}=15\text{V}$, $V_{CE}=600\text{V}$, $I_C=20\text{A}$)

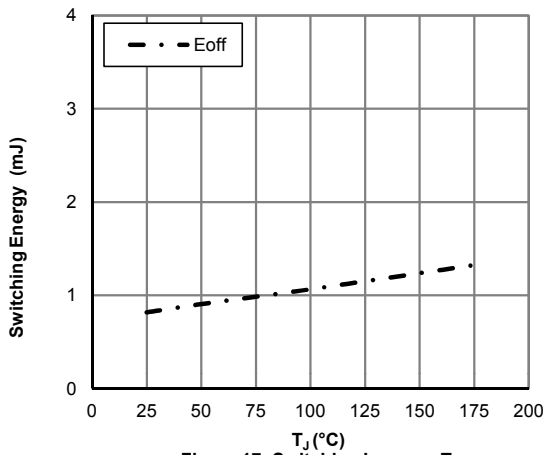

Figure 17: Switching Loss vs. T_J
($V_{GE}=15\text{V}$, $V_{CE}=600\text{V}$, $I_C=20\text{A}$, $R_g=15\Omega$)

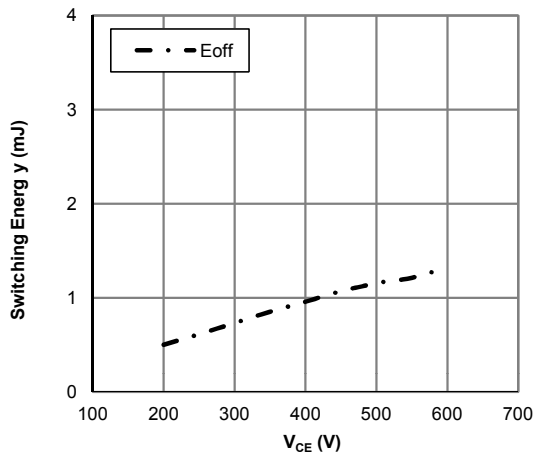

Figure 18: Switching Loss vs. V_{CE}
($T_J=175^\circ\text{C}$, $V_{GE}=15\text{V}$, $I_C=20\text{A}$, $R_g=15\Omega$)

TYPICAL ELECTRICAL AND THERMAL CHARACTERISTICS

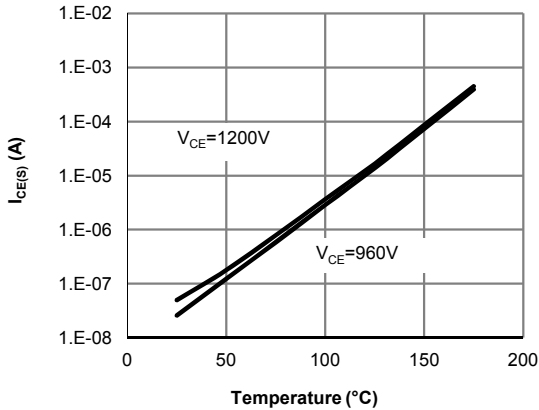

Figure 19: Diode Reverse Leakage Current vs. Junction Temperature

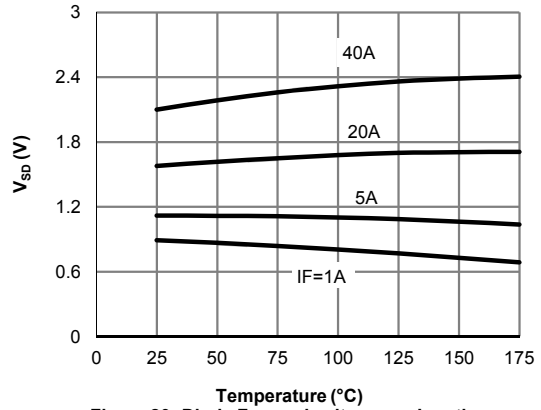

Figure 20: Diode Forward voltage vs. Junction Temperature

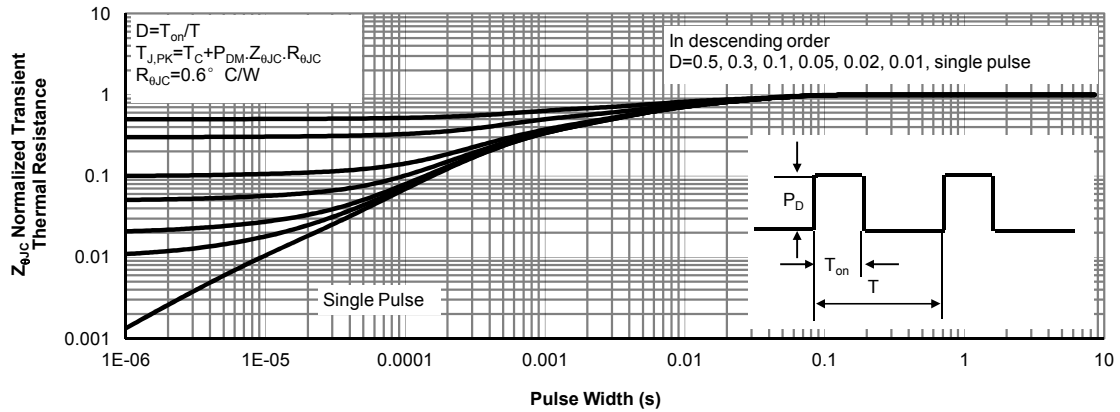

Figure 21: Normalized Maximum Transient Thermal Impedance for IGBT

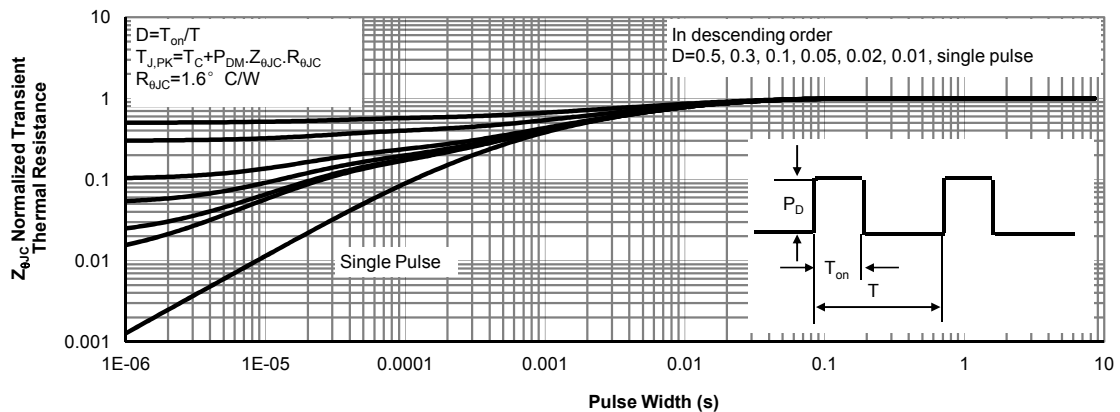

Figure 22: Normalized Maximum Transient Thermal Impedance for Diode

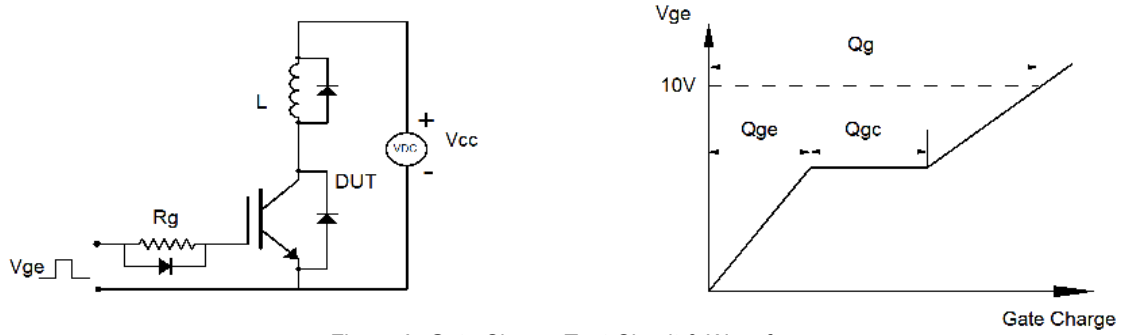

Figure A: Gate Charge Test Circuit & Waveforms

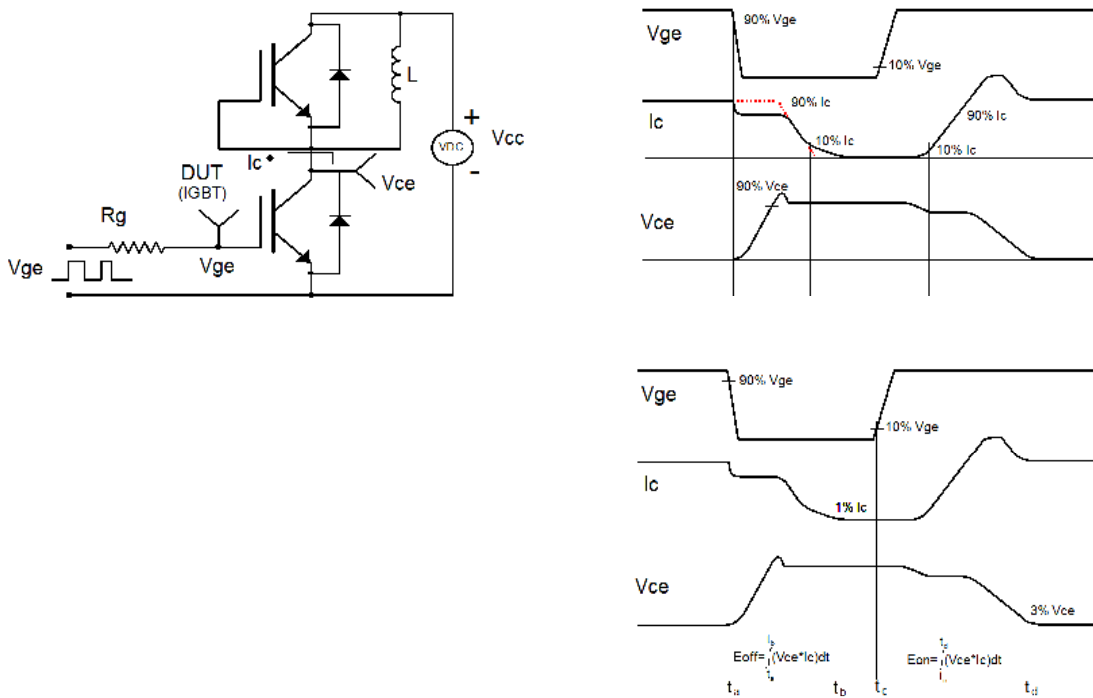

Figure B: Inductive Switching Test Circuit & Waveforms

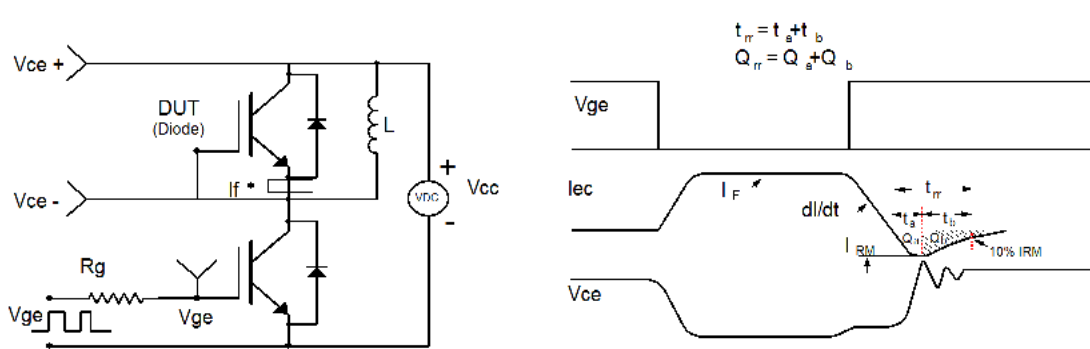

Figure C: Diode Recovery Test Circuit & Waveforms