

<p>GlobTek, Inc. www.globtek.com 186 Veterans Drive, Northvale, NJ 07647 Tel. (201) 784-1000 Fax (201) 784-0111</p>	<p>Drawing Title: GT-96300-3656-R2-AP, PoE, Active Power Injector, Efficiency Level: USA DOE Level VI / Eco-design Directive 2009/125/EC, (EU) 2019/1782, Case Color/Style: GlobTek Black, Wall Plug-in+Desktop Combination, Gigabit Power over Ethernet (IEEE802.3at PoE PSE) Power Supply AC Adaptor, Input Rating: 100-240V~, 50-60 Hz, IEC 60320/C8 w/ Wall Blades Option , Output Rating: 36W, 56.0V@0.64A, Output Configuration: N/A mm, N/A/ Cond, N/A, None, Ferrite: None, N/A, GT Cord # C0745, Pin Out: PoE injector wiring Data, Data+Power, RJ45 x 2, Blades/Input Cord: (Order Separately), Approvals: CB 62368; Patent US9838207B2; EAC; UKCA; Conforms to 62368-1; S-Mark 60950; ETL; CCC; Morocco; S-Mark 62368; IRAM; PSE; CB 60335; CE; WEEE; China RoHS; RoHS; Double Insulation; Level VI; Patent US9838207B2;</p>
	<p>Model No. GT-96300-3656-R2-AP</p>
	<p>Part No./Ordering No. GT-96300-3656-R2-AP</p>
	<p>Rev B</p>

In Addition to GlobTek Inc.'s renewed ISO9001:2015 - Quality Management System Certification, GlobTek Inc. is now certified to:

ISO13485:2016 - Medical Devices Quality Management System Certification  
ISO14001:2015 - Environmental Management System Certification

ISO Certificates are available online at <https://www.globtek.com/iso-certificates/>

The acceptance of this specification and use of the product described in this document indicates the acceptance and binding of the customer to Globtek TERMS AND CONDITIONS (attached to the end of this document), which supersede all other agreements, terms, and conditions (<https://en.globtek.com/terms-and-conditions/>).

The purchaser of this product (Customer) agrees that it is their sole responsibility to determine suitability/fitness of the product described in this specification for their application and to take precautions for protection against any hazards attendant to the handling and use of the product.

Footnote:

GlobTek Inc. will not be liable for the safety and performance of these power supplies/battery packs if unauthorized access and repair occurs. End user should consult applicable UL, CSA or EN standards for proper installation instruction.

Limitation of Use:

GlobTek products are intended for use with commercial, medical, and/or industrial equipment only. GlobTek product are not authorized for use as mission critical components in life support hazardous environment, nuclear or aircraft applications without prior written approval from the CEO of GlobTek Inc.

Contents of this document are subject to change without prior notice.

### Customer Approval of Specification:

Please approve, sign and send back to GlobTek so we can complete order processing.  
A delay in receipt of this form will delay delivery schedule.

Company Name: _____	Customer P/N: _____
Quote Number: _____	Date: _____
Authorized Representative Name: _____	Authorized Representative Signature: _____

GloTek, Inc. www.globtek.com 186 Veterans Drive, Northvale, NJ 07647 Tel. (201) 784-1000 Fax (201) 784-0111	Drawing Title: GT-96300-3656-R2-AP, PoE, Active Power Injector, Efficiency Level: USA DOE Level VI / Eco-design Directive 2009/125/EC, (EU) 2019/1782, Case Color/Style: GlobTek Black, Wall Plug-in+Desktop Combination, Gigabit Power over Ethernet (IEEE802.3at PoE PSE) Power Supply AC Adaptor, Input Rating: 100-240V~, 50-60 Hz, IEC 60320/C8 w/ Wall Blades Option , Output Rating: 36W, 56.0V@0.64A, Output Configuration: N/A mm, N/A/ Cond, N/A, None, Ferrite: None, N/A, GT Cord # C0745, Pin Out: PoE injector wiring Data, Data+Power, RJ45 x 2, Blades/Input Cord: (Order Separately), Approvals: CB 62368; Patent US9838207B2; EAC; UKCA; Conforms to 62368-1; S-Mark 60950; ETL; CCC; Morocco; S-Mark 62368; IRAM; PSE; CB 60335; CE; WEEE; China RoHS; RoHS; Double Insulation; Level VI; Patent US9838207B2;		
	Model No. GT-96300-3656-R2-AP		
	Part No./Ordering No. GT-96300-3656-R2-AP		Rev B

## REVISION HISTORY

REV	DESCRIPTION	SUB	DATE	APPROVED
B	Update pinout from POERJ45X2 to POE RJ45X2	QA	08/28/2019	QA
A	Initial Release	svlas	02/27/2019	QA

### POWER SUPPLY INFORMATION

TYPE	Wall Plug-in+Desktop Combination
TECHNOLOGY	Gigabit Power over Ethernet (IEEE802.3at PoE PSE) Power Supply AC Adaptor
CASE COLOR	GlobTek Black
NAMEPLATE RATED INPUT	100-240V~, 50-60 Hz, 1.0A
INPUT CONFIG	IEC 60320/C8 w/ Wall Blades Option
WATTS	36.00
VOLTS OUT	56.0
CURRENT OUT (Amps)	0.64
BLADE/CORD INCLUDED	None (Order Separately)
BLADE/CORD INSTALLED	None :(Order Separately)
INGRESS PROTECTION	IP40
GROUNDING CONFIGURATION	(F1) Class II / Double Insulated
EFFICIENCY LEVEL	USA DOE Level VI / Eco-design Directive 2009/125/EC, (EU) 2019/1782
OUTPUT CONFIGURATION	N/A mm, N/A/ Cond, N/A, None, Ferrite: None, N/A, GT Cord # C0745
CONNECTOR PIN OUT	PoE injector wiring Data, Data+Power, RJ45 x 2
LABEL SPECS	Standard GT,L-1186
SPECIAL BARCODE LABEL MATERIAL	No
PACK SPEC	Standard DT, Cellular packaging
USER MANUAL	

#### PROPRIETARY INFORMATION

<p>GlobTek, Inc.  www.globtek.com  186 Veterans Drive,  Northvale, NJ 07647  Tel. (201) 784-1000  Fax (201) 784-0111</p>	<p>Drawing Title: GT-96300-3656-R2-AP, PoE, Active Power Injector, Efficiency Level: USA DOE Level VI / Eco-design Directive 2009/125/EC, (EU) 2019/1782, Case Color/Style: GlobTek Black, Wall Plug-in+Desktop Combination, Gigabit Power over Ethernet (IEEE802.3at PoE PSE) Power Supply AC Adaptor, Input Rating: 100-240V~, 50-60 Hz, IEC 60320/C8 w/ Wall Blades Option , Output Rating: 36W, 56.0V@0.64A, Output Configuration: N/A mm, N/A/ Cond, N/A, None, Ferrite: None, N/A, GT Cord # C0745, Pin Out: PoE injector wiring Data, Data+Power, RJ45 x 2, Blades/Input Cord: (Order Separately), Approvals: CB 62368; Patent US9838207B2; EAC; UKCA; Conforms to 62368-1; S-Mark 60950; ETL; CCC; Morocco; S-Mark 62368; IRAM; PSE; CB 60335; CE; WEEE; China RoHS; RoHS; Double Insulation; Level VI; Patent US9838207B2;</p>
	<p>Model No. GT-96300-3656-R2-AP</p>
	<p>Part No./Ordering No. GT-96300-3656-R2-AP</p>
	<p>Rev B</p>

Notes/Modifications/Customizations (notes in this section supersede the values shown in the standard spec)  
DIMENSIONS ARE IN MM UNLESS SPECIFIED OTHERWISE

GloTek, Inc. www.globtek.com 186 Veterans Drive, Northvale, NJ 07647 Tel. (201) 784-1000 Fax (201) 784-0111	Drawing Title: GT-96300-3656-R2-AP, PoE, Active Power Injector, Efficiency Level: USA DOE Level VI / Eco-design Directive 2009/125/EC, (EU) 2019/1782, Case Color/Style: GlobTek Black, Wall Plug-in+Desktop Combination, Gigabit Power over Ethernet (IEEE802.3at PoE PSE) Power Supply AC Adaptor, Input Rating: 100-240V~, 50-60 Hz, IEC 60320/C8 w/ Wall Blades Option , Output Rating: 36W, 56.0V@0.64A, Output Configuration: N/A mm, N/A/ Cond, N/A, None, Ferrite: None, N/A, GT Cord # C0745, Pin Out: PoE injector wiring Data, Data+Power, RJ45 x 2, Blades/Input Cord: (Order Separately), Approvals: CB 62368; Patent US9838207B2; EAC; UKCA; Conforms to 62368-1; S-Mark 60950; ETL; CCC; Morocco; S-Mark 62368; IRAM; PSE; CB 60335; CE; WEEE; China RoHS; RoHS; Double Insulation; Level VI; Patent US9838207B2;	
	Model No. GT-96300-3656-R2-AP	
	Part No./Ordering No. GT-96300-3656-R2-AP	Rev B

## ELECTRICAL SPECIFICATIONS

GloTek's GT-96300-3656 Active Power over Ethernet Midspan Injector offers cost effective and reliable solution for remote powering of Wireless LAN Access Points, Voice over IP phones, Security Cameras, RFID readers and other IP terminals up to 36 Watts over existing network infrastructure. This injector is configured to provide 36 watts of power per port over two pairs in compliance with IEEE 802.3at standard.

The GT-96300-3656 Active PoE Injector is designed to function with and provide power to any IEEE 802.3at compliant PoE device.

### MAIN FEATURES

- Withstands high energy EMI Immunity events without going into latched shutdown state
- Enhanced 36W output power capability
- IEEE 802.3at Detection, 2 Event classification, Disconnect and Overload Protection
- LED User Interface for Power Good and Fault Conditions
- Compliant to PoE+, 10/100/1000 BaseT Data Rates
- Universal Input Power from 100Vac to 240Vac
- Unique Patented Green Design: Compliant to DoE Efficiency level VI requirement
- Full Protection for Over Voltage and Current
- Compact 104 x 54 x 40 mm (w/o MTG Flange)

### APPLICATIONS

- VoIP Phones
- VoIP Phone with Video
- Wireless Access Points
- Bluetooth Access Points
- Multi-Band Wireless Access Points
- Network Security Cameras
- Point of Sales
- Industrial Controllers
- Electronic Time Card Readers
- Building Security Systems
- Network Camera with Pan, Tilt and Zoom Features
- Electronic Signs
- RFID Readers
- Motion Sensors
- HVAC Controllers
- Magnetic Card Readers
- PDAs
- Digital Time clock

### A) ELECTRICAL SPECIFICATIONS:

#### INPUT

#### PROPRIETARY INFORMATION

PROPRIETARY OF GLOBTEK, INC. ANY REPRODUCTION, DISCLOSURE OR USE OF THIS DRAWING, IN WHOLE OR IN PART, IS HEREBY PROHIBITED EXCEPT AS SPECIFIED IN WRITING BY GLOBTEK, INC. © GlobTek, Inc. 2019 - 2023

GlobTek, Inc. www.globtek.com 186 Veterans Drive, Northvale, NJ 07647 Tel. (201) 784-1000 Fax (201) 784-0111	Drawing Title: GT-96300-3656-R2-AP, PoE, Active Power Injector, Efficiency Level: USA DOE Level VI / Eco-design Directive 2009/125/EC, (EU) 2019/1782, Case Color/Style: GlobTek Black, Wall Plug-in+Desktop Combination, Gigabit Power over Ethernet (IEEE802.3at PoE PSE) Power Supply AC Adaptor, Input Rating: 100-240V~, 50-60 Hz, IEC 60320/C8 w/ Wall Blades Option , Output Rating: 36W, 56.0V@0.64A, Output Configuration: N/A mm, N/A/ Cond, N/A, None, Ferrite: None, N/A, GT Cord # C0745, Pin Out: PoE injector wiring Data, Data+Power, RJ45 x 2, Blades/Input Cord: (Order Separately), Approvals: CB 62368; Patent US9838207B2; EAC; UKCA; Conforms to 62368-1; S-Mark 60950; ETL; CCC; Morocco; S-Mark 62368; IRAM; PSE; CB 60335; CE; WEEE; China RoHS; RoHS; Double Insulation; Level VI; Patent US9838207B2;	
	Model No. GT-96300-3656-R2-AP	
	Part No./Ordering No. GT-96300-3656-R2-AP	Rev B

Input Range: 90-264 Vac (85-264Vac @ 85% of rated output power)  
Input Line Frequency: 47-63Hz  
Input Current:< 1A RMS @ 90Vac Full Load  
Inrush Current: 60A Typical, Cold Start @ 25°C at 230Vac  
No load Power: < 100mW  
Efficiency: >87.4%, 4 Point Avg efficiency. Typical at Full Load , 230 Vac  
Turn on-delay: 1 Second Typical @ 115Vac  
Input Line Protection: MOV Transient protected.  
Hold-up time: 8ms typical at nominal input voltage and full load  
Leakage current: <100uA  
Isolation: 3000 VAC

#### OUTPUT

Number of Ports: One

Data Rates: Compliant to PoE+, 10/100/1000 Mb/s Ethernet Speed

Power Injection Method: For IEEE 802.3at Midspan, 4&5 for V+ and 7&8 for Common

Port Voltage: 56Vdc nom at pins 4&5 to 7&8

Port Current: 0 to 640mA max for pins 4&5 to 7&8

Port Power: 36W max from pins 4&5 to 7&8

Port Voltage Regulation: Complies with IEEE 802.3at requirements

Port Voltage Ripple: Complies with IEEE 802.3at requirements

Port Voltage Transient Performance: Complies with IEEE 802.3at requirements

Port Overload Protection: Complies with IEEE 802.3at Requirements. Port will shutdown during overload and auto recover when overload is removed.

Port Short Circuit Protection: Complies with IEEE 802.3at Requirements. Port will shutdown during short circuit and auto recover when short is removed.

Port Power Disconnection Method: Automatic Disconnect if < 10mA minimum load detected per IEEE 802.3at standard.

User Interface: Green LED Status Indicator, States as Follows:

No Light: No Powered Device detected at end of ethernet cable

Flashing at 1.5Hz: Detection (hand-shaking) in-Process, with Powered Device

Continuous Light: Good Connection with Powered Device

GloTek, Inc. www.globtek.com 186 Veterans Drive, Northvale, NJ 07647 Tel. (201) 784-1000 Fax (201) 784-0111	Drawing Title: GT-96300-3656-R2-AP, PoE, Active Power Injector, Efficiency Level: USA DOE Level VI / Eco-design Directive 2009/125/EC, (EU) 2019/1782, Case Color/Style: GlobTek Black, Wall Plug-in+Desktop Combination, Gigabit Power over Ethernet (IEEE802.3at PoE PSE) Power Supply AC Adaptor, Input Rating: 100-240V~, 50-60 Hz, IEC 60320/C8 w/ Wall Blades Option , Output Rating: 36W, 56.0V@0.64A, Output Configuration: N/A mm, N/A/ Cond, N/A, None, Ferrite: None, N/A, GT Cord # C0745, Pin Out: PoE injector wiring Data, Data+Power, RJ45 x 2, Blades/Input Cord: (Order Separately), Approvals: CB 62368; Patent US9838207B2; EAC; UKCA; Conforms to 62368-1; S-Mark 60950; ETL; CCC; Morocco; S-Mark 62368; IRAM; PSE; CB 60335; CE; WEEE; China RoHS; RoHS; Double Insulation; Level VI; Patent US9838207B2;	
	Model No. GT-96300-3656-R2-AP	
	Part No./Ordering No. GT-96300-3656-R2-AP	Rev B

Flashing at 10Hz: Over Current Condition

#### ENVIRONMENTAL

Temperature: Operating, -10C to 40C

Storage, -30C to 80C

Humidity: 0% to 95% Relative Humidity, Non-Condensing

Altitude: Operating, Up to 5000M

#### MECHANICALS / ENCLOSURE

Housing: High impact plastic, 94V0 polycarbonate, non-vented

Markings: Label and/or Pad Printed and/or Molded in the case Dimensions: 104\*54\*40 mm (w/o MTG Flange)

Weight: 0.35 Lb, 155 gr.

AC Input mechanical options: Desktop C6, C8, C14 or C18 IEC Inlet.

Hybrid option (Desktop or Changeable Blade Wall Plug-in) Class I or Class II input

Data and Data+Power Connector: Fully Shielded RJ45

#### D) EMISSIONS and IMMUNITY

Emission: Complies with FCC Class B Part 15, EN55022 Class B

Immunity: Complies with the following;

EN61000-6-2 (Industrial Level Immunity Compliance, extended levels shown in parenthesis)

EN 61000-4-2 ESD (+/-18KV Air, +/-8KV Contact, criteria A) (+/-20KV Air, +/-10KV Contact, criteria B)

EN 61000-4-3 Radiated Immunity

EN 61000-4-4 EFT (+/-2.5KV, criteria A) (+/-4KV, criteria B)

EN 61000-4-5 Surge (+/-2KV Line-Line, +/-4KV Line to Gnd, criteria A)

EN 61000-4-6 Conducted Susceptibility

EN 61000-4-11 Voltage Dips and Interrupts

EN 61000-3-2 Harmonics, Class A

#### REGULATORY COMPLIANCE

Compliant Safety Standards: See listings at end of this drawing for specifics

IEEE 802.3at: Product tested per the requirements of IEEE 802.3at

INTEROPERABILITY: Product's interoperability performance verified with various third party PoE enabled systems. See table below.

#### SPECIAL OPTIONS

1. Custom Markings
2. Reduced output power rating
3. Compatibility to 24W-30W output power Splitters using Data Link Layer Classification
4. High Rel PCB laminate with Plated through Holes for IPC610 Class 2 Compliance
5. Special Housing Colors
- 6.48V or 54V Output Voltage, contact factory for availability

#### PROPRIETARY INFORMATION

PROPRIETARY OF GLOBTEK, INC. ANY REPRODUCTION, DISCLOSURE OR USE OF THIS DRAWING, IN WHOLE OR IN PART, IS HEREBY PROHIBITED EXCEPT AS SPECIFIED IN WRITING BY GLOBTEK, INC. © GlobTek, Inc. 2019 - 2023

quest / 08/04/2023 1:36:51 PM GMT CLONED FROM GT-96300-3656-R3A-AP

GloTek, Inc. www.globtek.com 186 Veterans Drive, Northvale, NJ 07647 Tel. (201) 784-1000 Fax (201) 784-0111	Drawing Title: GT-96300-3656-R2-AP, PoE, Active Power Injector, Efficiency Level: USA DOE Level VI / Eco-design Directive 2009/125/EC, (EU) 2019/1782, Case Color/Style: GlobTek Black, Wall Plug-in+Desktop Combination, Gigabit Power over Ethernet (IEEE802.3at PoE PSE) Power Supply AC Adaptor, Input Rating: 100-240V~, 50-60 Hz, IEC 60320/C8 w/ Wall Blades Option , Output Rating: 36W, 56.0V@0.64A, Output Configuration: N/A mm, N/A/ Cond, N/A, None, Ferrite: None, N/A, GT Cord # C0745, Pin Out: PoE injector wiring Data, Data+Power, RJ45 x 2, Blades/Input Cord: (Order Separately), Approvals: CB 62368; Patent US9838207B2; EAC; UKCA; Conforms to 62368-1; S-Mark 60950; ETL; CCC; Morocco; S-Mark 62368; IRAM; PSE; CB 60335; CE; WEEE; China RoHS; RoHS; Double Insulation; Level VI; Patent US9838207B2;	
	Model No. GT-96300-3656-R2-AP	
	Part No./Ordering No. GT-96300-3656-R2-AP	Rev B

### 36W PoE Injector, Ethernet InterOperability and Compatibility Testing

Injector tested: *Model GT-96300-3656*, rated 36W output, 56Vdc, IEEE802.3-2009 at Compliant

*Note, assuming 80% eff splitter, max Pout = 28.8W (28.8/36 = 0.8)*

Splitter Model Used	Splitter Description	Splitter O/P Power Rating	Splitter Load During Testing
GloTek GT-91087	5V, af type	8W	7.5W
PowerDSIne PD-AS-601/5	5V, af type	10W	
Linksys POEES5	5V, af type	10W	
Axis 5008-001-02	5V, af type	10W	
PowerDSIne PD-AS-701/12	12V, at type	24W	24W
Phihong POE21-120-R	12V, at type	21W	21W
Cisco 7970 Series Phone	IP Phone, af type	Input to Phone rating 48V, 0.38A	

\* For 24W-30W output power Splitters using Data Link Layer Classification, contact GloTek for option availability.

### 100BaseT/1000 Base T network digital transmission testing

*(During testing ethernet communications is passed thru Injector and then Splitter and then to a computer)*

Injector tested: *Model GT-96300-3656*, rated 36W output, 56Vdc, IEEE802.3-2009 at Compliant

*Injector is Gigabit designed and tested, to 100 Base T and 1000 Base T*

Splitter Model Used	Splitter Description	P/F	Notes:
Axis 5008-001-02	100 Base T rating	P	Limited bandwidth splitter
PowerDSIne PD-AS-701/12	1000 Base T rating	P	Full bandwidth splitter

TO ADDRESS SYSTEM-LEVEL EMI CONCERNS, FERRITE CHOKES/BEADS MAY BE ADDED/REVISED UPON REQUEST. A SAMPLE KIT OF GLOBTEK'S STANDARD FERRITES IS AVAILABLE UNDER GLOBTEK P/N: EMI-MITIGATION-KIT1

FOR ADDITIONAL INFORMATION, PLEASE READ OUR WHITE PAPER AT: <https://r.globtek.info/3QeaqtD>

INGRESS PROTECTION: IP40

GlobTek, Inc.  
 www.globtek.com  
 186 Veterans Drive,  
 Northvale, NJ 07647  
 Tel. (201) 784-1000  
 Fax (201) 784-0111

Drawing Title: GT-96300-3656-R2-AP, PoE, Active Power Injector, Efficiency Level: USA DOE Level VI / Eco-design Directive 2009/125/EC, (EU) 2019/1782, Case Color/Style: GlobTek Black, Wall Plug-in+Desktop Combination, Gigabit Power over Ethernet (IEEE802.3at PoE PSE) Power Supply AC Adaptor, Input Rating: 100-240V~, 50-60 Hz, IEC 60320/C8 w/ Wall Blades Option, Output Rating: 36W, 56.0V@0.64A, Output Configuration: N/A mm, N/A/ Cond, N/A, None, Ferrite: None, N/A, GT Cord # C0745, Pin Out: PoE injector wiring Data, Data+Power, RJ45 x 2, Blades/Input Cord: (Order Separately), Approvals: CB 62368; Patent US9838207B2; EAC; UKCA; Conforms to 62368-1; S-Mark 60950; ETL; CCC; Morocco; S-Mark 62368; IRAM; PSE; CB 60335; CE; WEEE; China RoHS; RoHS; Double Insulation; Level VI; Patent US9838207B2;

Model No. GT-96300-3656-R2-AP

Part No./Ordering No. GT-96300-3656-R2-AP

Rev B

3D File Download <https://www.globtek.com/file/dl/gt-96180-1856-r2-ap.stp>

Mechanical drawing

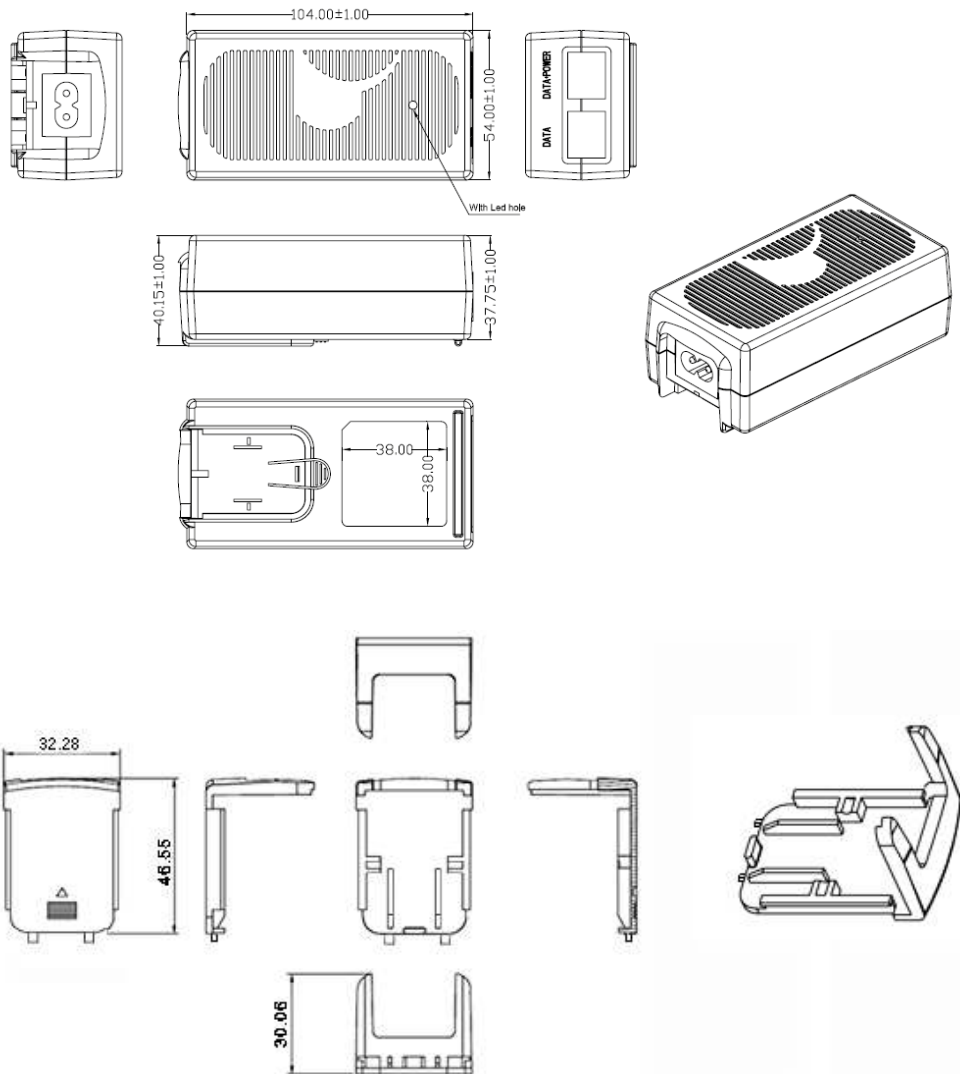



<p>GlobTek, Inc.  www.globtek.com  186 Veterans Drive,  Northvale, NJ 07647  Tel. (201) 784-1000  Fax (201) 784-0111</p>	<p>Drawing Title: GT-96300-3656-R2-AP, PoE, Active Power Injector, Efficiency Level: USA DOE Level VI / Eco-design Directive 2009/125/EC, (EU) 2019/1782, Case Color/Style: GlobTek Black, Wall Plug-in+Desktop Combination, Gigabit Power over Ethernet (IEEE802.3at PoE PSE) Power Supply AC Adaptor, Input Rating: 100-240V~, 50-60 Hz, IEC 60320/C8 w/ Wall Blades Option , Output Rating: 36W, 56.0V@0.64A, Output Configuration: N/A mm, N/A/ Cond, N/A, None, Ferrite: None, N/A, GT Cord # C0745, Pin Out: PoE injector wiring Data, Data+Power, RJ45 x 2, Blades/Input Cord: (Order Separately), Approvals: CB 62368; Patent US9838207B2; EAC; UKCA; Conforms to 62368-1; S-Mark 60950; ETL; CCC; Morocco; S-Mark 62368; IRAM; PSE; CB 60335; CE; WEEE; China RoHS; RoHS; Double Insulation; Level VI; Patent US9838207B2;</p>
	<p>Model No. GT-96300-3656-R2-AP</p>
	<p>Part No./Ordering No. GT-96300-3656-R2-AP <span style="float: right;">Rev B</span></p>

Unit shipped without an installed input plug.  
“Desktop insert” installed.

GlobTek, Inc.  
 www.globtek.com  
 186 Veterans Drive,  
 Northvale, NJ 07647  
 Tel. (201) 784-1000  
 Fax (201) 784-0111

Drawing Title: GT-96300-3656-R2-AP, PoE, Active Power Injector, Efficiency Level: USA DOE Level VI / Eco-design Directive 2009/125/EC, (EU) 2019/1782, Case Color/Style: GlobTek Black, Wall Plug-in+Desktop Combination, Gigabit Power over Ethernet (IEEE802.3at PoE PSE) Power Supply AC Adaptor, Input Rating: 100-240V~, 50-60 Hz, IEC 60320/C8 w/ Wall Blades Option , Output Rating: 36W, 56.0V@0.64A, Output Configuration: N/A mm, N/A/ Cond, N/A, None, Ferrite: None, N/A, GT Cord # C0745, Pin Out: PoE injector wiring Data, Data+Power, RJ45 x 2, Blades/Input Cord: (Order Separately), Approvals: CB 62368; Patent US9838207B2; EAC; UKCA; Conforms to 62368-1; S-Mark 60950; ETL; CCC; Morocco; S-Mark 62368; IRAM; PSE; CB 60335; CE; WEEE; China RoHS; RoHS; Double Insulation; Level VI; Patent US9838207B2;

Model No. GT-96300-3656-R2-AP

Part No./Ordering No. GT-96300-3656-R2-AP

Rev B

DERATING CURVE

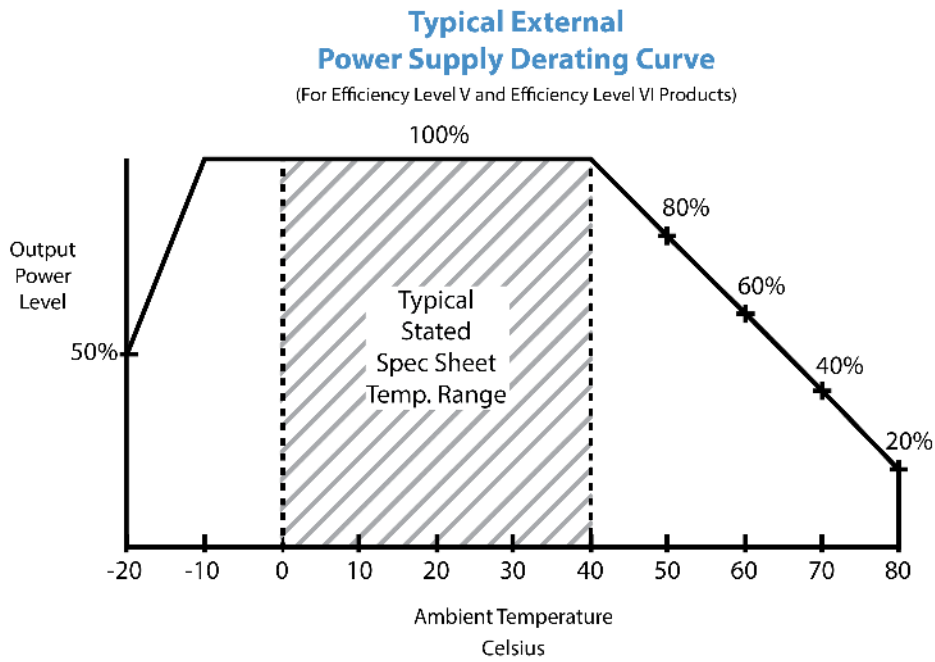

GlobTek, Inc. www.globtek.com 186 Veterans Drive, Northvale, NJ 07647 Tel. (201) 784-1000 Fax (201) 784-0111	Drawing Title: GT-96300-3656-R2-AP, PoE, Active Power Injector, Efficiency Level: USA DOE Level VI / Eco-design Directive 2009/125/EC, (EU) 2019/1782, Case Color/Style: GlobTek Black, Wall Plug-in+Desktop Combination, Gigabit Power over Ethernet (IEEE802.3at PoE PSE) Power Supply AC Adaptor, Input Rating: 100-240V~, 50-60 Hz, IEC 60320/C8 w/ Wall Blades Option , Output Rating: 36W, 56.0V@0.64A, Output Configuration: N/A mm, N/A/ Cond, N/A, None, Ferrite: None, N/A, GT Cord # C0745, Pin Out: PoE injector wiring Data, Data+Power, RJ45 x 2, Blades/Input Cord: (Order Separately), Approvals: CB 62368; Patent US9838207B2; EAC; UKCA; Conforms to 62368-1; S-Mark 60950; ETL; CCC; Morocco; S-Mark 62368; IRAM; PSE; CB 60335; CE; WEEE; China RoHS; RoHS; Double Insulation; Level VI; Patent US9838207B2;	
	Model No. GT-96300-3656-R2-AP	
	Part No./Ordering No. GT-96300-3656-R2-AP	Rev B

### INPUT CONFIGURATION

(F1) Class II / Double Insulated

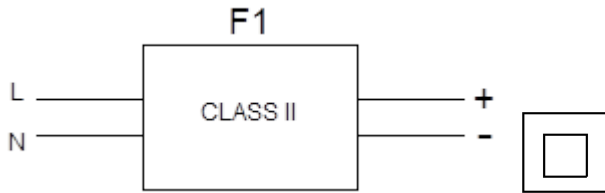

[Alternate grounding configurations](#) available upon request.

Blades/Cord Included:None:(Order Separately)

Blades/Cord Installed:None:(Order Separately)

IEC 60320/C8 AC Inlet connector

[Blade Insertion Instructions](#)  
[R-Blade Style Instruction Video](#)

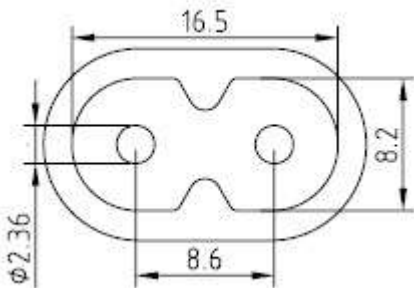

Mates with IEC 60320/C8 Plug

This series of Interchangeable Blade products may be used with Proprietary Interchangeable Blades as described below or with standard international power cords.

Optional INPUT BLADES: R-Socket: below are available blades configurations which are "not included" (unless stated above); may be purchased separately, packaged with power supply, or as a separate "R-KIT" if specified

#	Part Number	Main Country/Region	Plug	IECEE Type
1	<a href="#">R-NA-2(R)</a>	North America, Japan	Nema 1-15P	Type A

#### PROPRIETARY INFORMATION

GloTek, Inc. www.globtek.com 186 Veterans Drive, Northvale, NJ 07647 Tel. (201) 784-1000 Fax (201) 784-0111	Drawing Title: GT-96300-3656-R2-AP, PoE, Active Power Injector, Efficiency Level: USA DOE Level VI / Eco-design Directive 2009/125/EC, (EU) 2019/1782, Case Color/Style: GlobTek Black, Wall Plug-in+Desktop Combination, Gigabit Power over Ethernet (IEEE802.3at PoE PSE) Power Supply AC Adaptor, Input Rating: 100-240V~, 50-60 Hz, IEC 60320/C8 w/ Wall Blades Option , Output Rating: 36W, 56.0V@0.64A, Output Configuration: N/A mm, N/A/ Cond, N/A, None, Ferrite: None, N/A, GT Cord # C0745, Pin Out: PoE injector wiring Data, Data+Power, RJ45 x 2, Blades/Input Cord: (Order Separately), Approvals: CB 62368; Patent US9838207B2; EAC; UKCA; Conforms to 62368-1; S-Mark 60950; ETL; CCC; Morocco; S-Mark 62368; IRAM; PSE; CB 60335; CE; WEEE; China RoHS; RoHS; Double Insulation; Level VI; Patent US9838207B2;	
	Model No. GT-96300-3656-R2-AP	
	Part No./Ordering No. GT-96300-3656-R2-AP	Rev B

2 <a href="#">R-SAA-2(R)</a>	Australia/New Zealand	AS/NZ 3112	Type I
3 <a href="#">R-UK-2(R)</a>	United Kingdom/Ireland	UK, Hong Kong, Singapore, Gulf States	Type G
4 <a href="#">R-EU-2(R)</a>	Europe	CEE 7/16	Type C
5 <a href="#">R-CN-2(R)</a>	China	GB 2099	Type A
6 <a href="#">461-03030003(R)</a>	N/A	<a href="#">R-DI(R) Desktop Insert for use with a cord</a>	N/A
7 <a href="#">R-KIT-2(R)</a>	prepackaged kit	1,2,3,4 above	N/A
8 <a href="#">R-KIT-2-INTL(R)</a>	prepackaged kit	2,3,4 above	N/A



### UL 2P

P/N: R-NA-2(R)  
NORTH AMERICA  
JAPAN



### AUS 2P

P/N: R-SAA-2(R)  
AUSTRALIA

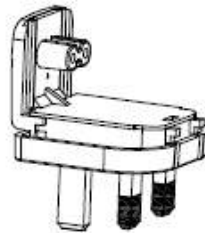

### UK 2P

P/N: R-UK-2(R)  
UNITED KINGDOM  
HONG KONG  
SINGAPORE



### EU 2P

P/N: R-EU-2(R)  
EUROPE  
SOUTH AMERICA



### CN 2P

P/N: R-CN-2(R)  
CHINA

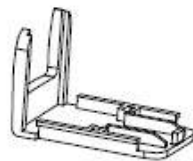

### R-DI

P/N: R-DI  
DESKTOP INSERT

GloTek, Inc. www.globtek.com 186 Veterans Drive, Northvale, NJ 07647 Tel. (201) 784-1000 Fax (201) 784-0111	Drawing Title: GT-96300-3656-R2-AP, PoE, Active Power Injector, Efficiency Level: USA DOE Level VI / Eco-design Directive 2009/125/EC, (EU) 2019/1782, Case Color/Style: GlobTek Black, Wall Plug-in+Desktop Combination, Gigabit Power over Ethernet (IEEE802.3at PoE PSE) Power Supply AC Adaptor, Input Rating: 100-240V~, 50-60 Hz, IEC 60320/C8 w/ Wall Blades Option , Output Rating: 36W, 56.0V@0.64A, Output Configuration: N/A mm, N/A/ Cond, N/A, None, Ferrite: None, N/A, GT Cord # C0745, Pin Out: PoE injector wiring Data, Data+Power, RJ45 x 2, Blades/Input Cord: (Order Separately), Approvals: CB 62368; Patent US9838207B2; EAC; UKCA; Conforms to 62368-1; S-Mark 60950; ETL; CCC; Morocco; S-Mark 62368; IRAM; PSE; CB 60335; CE; WEEE; China RoHS; RoHS; Double Insulation; Level VI; Patent US9838207B2;	
	Model No. GT-96300-3656-R2-AP	
	Part No./Ordering No. GT-96300-3656-R2-AP	Rev B

#### Standard Cordsets

Below are standard cordsets which are "not included" (unless stated above); these may be purchased separately or packaged with the power supply. Contact your Sales Engineer if the style required is not shown below. Many more available in different lengths, colors or cable material.

#### Standard International IEC 320/C7 Cordsets

Part Number	Country	Plug	Connector	Length (mm)	Length (feet)
<a href="#">2094112M703(R)</a>	Argentina (Type I)	IRAM 2063	IEC 320/C7	2000	7
<a href="#">5014112M703A(R)</a>	Australian (Type I)	AS 3112	IEC 320/C7	2000	7
<a href="#">207B4111M8703(R)</a>	Brazil (Type N)	NBR14136	IEC 320/C7	1800	6
<a href="#">4533501M8703(R)</a>	China (Type A)	GB 2099.1	IEC 320/C7	1830	6
<a href="#">2074112M703A(R)</a>	European (Type C)	CEE 7/16	IEC 320/C7	2000	7
<a href="#">2084111M8703(R)</a>	South Africa (Type M)	BS 546	IEC 320/C7	1800	6
2084111M8703B(R)	India (Type D)	ISI:1293	IEC 320/C7	1800	6
<a href="#">2714111M8703A(R)</a>	India (Type C)	ISI:1293	IEC 320/C7	1800	6
<a href="#">451J3401M8703(R)</a>	Japan (Type A)	JIS 8303	IEC 320/C7	1830	6
<a href="#">2044112M703A(R)</a>	Korea (Type C)	KS C8305	IEC 320/C7	2000	7
<a href="#">4511116F703A(R)</a>	N. American (Type A)	NEMA 1-15P	IEC 320/C7	1830	6
<a href="#">4033401M8703A(R)</a>	Taiwan (Type A)	CNS690	IEC 320/C7	1830	6
<a href="#">6104112M703A(R)</a>	UK, Hong Kong, Singapore, Gulf States (Type G)	BS1363	IEC 320/C7	2000	7

GloTek, Inc. www.globtek.com 186 Veterans Drive, Northvale, NJ 07647 Tel. (201) 784-1000 Fax (201) 784-0111	Drawing Title: GT-96300-3656-R2-AP, PoE, Active Power Injector, Efficiency Level: USA DOE Level VI / Eco-design Directive 2009/125/EC, (EU) 2019/1782, Case Color/Style: GlobTek Black, Wall Plug-in+Desktop Combination, Gigabit Power over Ethernet (IEEE802.3at PoE PSE) Power Supply AC Adaptor, Input Rating: 100-240V~, 50-60 Hz, IEC 60320/C8 w/ Wall Blades Option , Output Rating: 36W, 56.0V@0.64A, Output Configuration: N/A mm, N/A/ Cond, N/A, None, Ferrite: None, N/A, GT Cord # C0745, Pin Out: PoE injector wiring Data, Data+Power, RJ45 x 2, Blades/Input Cord: (Order Separately), Approvals: CB 62368; Patent US9838207B2; EAC; UKCA; Conforms to 62368-1; S-Mark 60950; ETL; CCC; Morocco; S-Mark 62368; IRAM; PSE; CB 60335; CE; WEEE; China RoHS; RoHS; Double Insulation; Level VI; Patent US9838207B2;	
	Model No. GT-96300-3656-R2-AP	
	Part No./Ordering No. GT-96300-3656-R2-AP	Rev B

OUTPUT CORD AND CONNECTOR: **None/C0745**

ACTUAL CONNECTORS, OVERMOLDS, FERRITES MAY VARY SLIGHTLY FROM THE PICTURE BELOW

CABLE TYPE	N/A
CABLE LENGTH (mm)	N/A
CABLE TOLERANCE (mm)	N/A
WIRE GAUGE (AWG)	N/A
CONDUCTORS	
HANK DIMENSION (mm)	N/A
CABLE / CONNECTOR OVERMOLD COLOR	N/A
FERRITE TYPE AND DIMENSION	None
FERRITE NUMBER OF TURNS <a href="#">(Definition)</a>	N/A
FERRITE DIMENSION FROM STRAIN RELIEF	N/A
FERRITE DIMENSION FROM PLUG	N/A
PLUG TYPE	None
OVER MOLD ORIENTATION	N/A
CONNECTOR PIN OUT	PoE injector wiring Data, Data+Power, RJ45 x 2

ADDITIONAL OUTPUT PLUG OPTIONS ARE AVAILABLE AT <https://www.globtek.com/connectors/>

STANDARD PLUGS AND CONNECTORS CAN BE SEEN ONLINE AT <https://www.globtek.com/connectors/>

CALCULATE VOLTAGE REGULATION/DROP WITH OUR ONLINE CALCULATOR: <https://en.globtek.com/output-cable-regulation-calculator/>

<p>GlobTek, Inc.  www.globtek.com  186 Veterans Drive,  Northvale, NJ 07647  Tel. (201) 784-1000  Fax (201) 784-0111</p>	<p>Drawing Title: GT-96300-3656-R2-AP, PoE, Active Power Injector, Efficiency Level: USA DOE Level VI / Eco-design Directive 2009/125/EC, (EU) 2019/1782, Case Color/Style: GlobTek Black, Wall Plug-in+Desktop Combination, Gigabit Power over Ethernet (IEEE802.3at PoE PSE) Power Supply AC Adaptor, Input Rating: 100-240V~, 50-60 Hz, IEC 60320/C8 w/ Wall Blades Option , Output Rating: 36W, 56.0V@0.64A, Output Configuration: N/A mm, N/A/ Cond, N/A, None, Ferrite: None, N/A, GT Cord # C0745, Pin Out: PoE injector wiring Data, Data+Power, RJ45 x 2, Blades/Input Cord: (Order Separately), Approvals: CB 62368; Patent US9838207B2; EAC; UKCA; Conforms to 62368-1; S-Mark 60950; ETL; CCC; Morocco; S-Mark 62368; IRAM; PSE; CB 60335; CE; WEEE; China RoHS; RoHS; Double Insulation; Level VI; Patent US9838207B2;</p>
	<p>Model No. GT-96300-3656-R2-AP</p>
	<p>Part No./Ordering No. GT-96300-3656-R2-AP</p>
	<p>Rev B</p>

**OUTPUT CONNECTOR HOOK UP**

TO ADDRESS SYSTEM-LEVEL EMI CONCERNS, FERRITE CHOKES/BEADS MAY BE ADDED/REVISED UPON REQUEST. A SAMPLE KIT OF GLOBTEK'S STANDARD FERRITES IS AVAILABLE UNDER GLOBTEK P/N: EMI-MITIGATION-KIT1

FOR ADDITIONAL INFORMATION, PLEASE READ OUR WHITE PAPER AT:

<https://en.globtek.com/technical-articles/ferrite-kit-radiated-emi-suppression-kit-for-globtek-power-supplies-cable-assemblies>

GloTek, Inc. www.globtek.com 186 Veterans Drive, Northvale, NJ 07647 Tel. (201) 784-1000 Fax (201) 784-0111	Drawing Title: GT-96300-3656-R2-AP, PoE, Active Power Injector, Efficiency Level: USA DOE Level VI / Eco-design Directive 2009/125/EC, (EU) 2019/1782, Case Color/Style: GlobTek Black, Wall Plug-in+Desktop Combination, Gigabit Power over Ethernet (IEEE802.3at PoE PSE) Power Supply AC Adaptor, Input Rating: 100-240V~, 50-60 Hz, IEC 60320/C8 w/ Wall Blades Option , Output Rating: 36W, 56.0V@0.64A, Output Configuration: N/A mm, N/A/ Cond, N/A, None, Ferrite: None, N/A, GT Cord # C0745, Pin Out: PoE injector wiring Data, Data+Power, RJ45 x 2, Blades/Input Cord: (Order Separately), Approvals: CB 62368; Patent US9838207B2; EAC; UKCA; Conforms to 62368-1; S-Mark 60950; ETL; CCC; Morocco; S-Mark 62368; IRAM; PSE; CB 60335; CE; WEEE; China RoHS; RoHS; Double Insulation; Level VI; Patent US9838207B2;	
	Model No. GT-96300-3656-R2-AP	Rev B
Part No./Ordering No. GT-96300-3656-R2-AP		

**LABEL:L-1186**

LABEL P/N	Standard GT
MATERIAL	Flat Thermal Transfer, Imprintable, Polyester Label and/or Pad Printed and/or Molded, and/or Laser Engraved in the case
BACKGROUND COLOR	Black if housing is Black, White or Silver if housing is White or Gray.
TEXT COLOR	White or Silver if label is Black Background for Black housing. Black if label is White or Silver background and Housing is White or Gray.
LABEL WIDTH (mm)	38
LABEL HEIGHT (mm)	38
SPECIAL BARCODE LABEL MATERIAL	No

Below is the minimum information which will appear on the label. NOTE: in the logo area additional/actual positioning of symbols and text is subjected to change as per agency updates/requirements or additional model approvals become available.  
Regulatory certifications/label markings may be in logo area on the label or molded into the case housing outside the label area.  
Information will be shown via label and/or pad printed and/or molded and/or laser engraved in the case. \* Date code markings at GlobTek option



or  
**DATE CODE B \*:**  
WWYY  
WW = WEEK  
YY = YEAR

A=PoE, Active Power Injector  
B=P/N: (料号) GT-96300-3656-R2-AP  
C=Model (型号) GT-96300-3656-R2-AP  
D=Input (输入)100-240V~, 50-60 Hz, 1.0A  
E=Output (输出)56.0 V 0.64 A, 36.00W



GloTek, Inc. www.globtek.com 186 Veterans Drive, Northvale, NJ 07647 Tel. (201) 784-1000 Fax (201) 784-0111	Drawing Title: GT-96300-3656-R2-AP, PoE, Active Power Injector, Efficiency Level: USA DOE Level VI / Eco-design Directive 2009/125/EC, (EU) 2019/1782, Case Color/Style: GlobTek Black, Wall Plug-in+Desktop Combination, Gigabit Power over Ethernet (IEEE802.3at PoE PSE) Power Supply AC Adaptor, Input Rating: 100-240V~, 50-60 Hz, IEC 60320/C8 w/ Wall Blades Option , Output Rating: 36W, 56.0V@0.64A, Output Configuration: N/A mm, N/A/ Cond, N/A, None, Ferrite: None, N/A, GT Cord # C0745, Pin Out: PoE injector wiring Data, Data+Power, RJ45 x 2, Blades/Input Cord: (Order Separately), Approvals: CB 62368; Patent US9838207B2; EAC; UKCA; Conforms to 62368-1; S-Mark 60950; ETL; CCC; Morocco; S-Mark 62368; IRAM; PSE; CB 60335; CE; WEEE; China RoHS; RoHS; Double Insulation; Level VI; Patent US9838207B2;	
	Model No. GT-96300-3656-R2-AP	
	Part No./Ordering No. GT-96300-3656-R2-AP	Rev B

AGENCY ONLINE DOCUMENTS	<a href="http://www.globtek.info/certs/GT-96300-POE/">http://www.globtek.info/certs/GT-96300-POE/</a>
CE EC-Declaration for Medical	<a href="#">Contact GlobTek for more information</a>
CE EC-Declaration for Industrial/Commercial/ITE	<a href="http://globtek.force.com/models/ec_declaration_product?id=01t0c000008vvUg&amp;i=2">http://globtek.force.com/models/ec_declaration_product?id=01t0c000008vvUg&amp;i=2</a>
CE EC-Declaration for Household	<a href="#">Contact GlobTek for more information</a>
UKCA-Declaration for Medical	<a href="#">Contact GlobTek for more information</a>
UKCA-Declaration for Industrial/Commercial/ITE	<a href="http://globtek.force.com/models/ukca_declaration_product?id=01t0c000008vvUg&amp;i=2">http://globtek.force.com/models/ukca_declaration_product?id=01t0c000008vvUg&amp;i=2</a>
UKCA-Declaration for Household	<a href="#">Contact GlobTek for more information</a>
Morocco SDoC Declaration	<a href="https://globtek.secure.force.com/models/Morocco_SDoC_Declaration?id=a0Oa000000MmZF5EAN">https://globtek.secure.force.com/models/Morocco_SDoC_Declaration?id=a0Oa000000MmZF5EAN</a>
RoHS/RoHS3 Declaration	<a href="https://www.globtek.com/pdf/rohs_cert/01t0c000008vvUgAAI">https://www.globtek.com/pdf/rohs_cert/01t0c000008vvUgAAI</a>
REACH Declaration	<a href="https://www.globtek.com/pdf/iso_certificates/REACH.pdf">https://www.globtek.com/pdf/iso_certificates/REACH.pdf</a>
Conflict Minerals Declaration	<a href="https://www.globtek.com/pdf/conflict-minerals.pdf">https://www.globtek.com/pdf/conflict-minerals.pdf</a>
Prop 65 Statement	<a href="https://en.globtek.com/prop-65-statement.pdf">https://en.globtek.com/prop-65-statement.pdf</a>
IPXY rating is based on 3rd party testing and customers should check suitability and test system level IPXY rating before ordering.	

## Regulatory Certifications/Label Markings

Below follows a link to the latest regulatory certifications and marks for this specific product. National standards as well as certification schemes are constantly changing and so is the set of certification marks and symbols applicable to this product. Various standards, marks and symbols, and certificates are subject to change at any time without notice.

Additional standards or unique country certifications are available upon request. Please contact Globtek to request a quotation.

LATEST PRODUCT/MODEL CERTIFICATIONS: <https://www.globtek.com/datasheet/w71100>

AGENCY ONLINE DOCUMENTS <http://www.globtek.info/certs/GT-96300-POE/>



(F1) Class II / Double Insulated

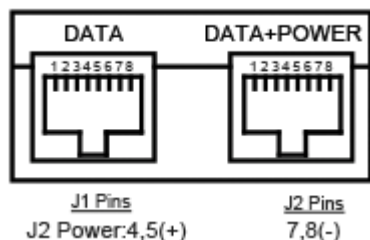

PoE injector wiring Data, Data+Power, RJ45 x 2

<p>GlobTek, Inc. www.globtek.com 186 Veterans Drive, Northvale, NJ 07647 Tel. (201) 784-1000 Fax (201) 784-0111</p>	<p>Drawing Title: GT-96300-3656-R2-AP, PoE, Active Power Injector, Efficiency Level: USA DOE Level VI / Eco-design Directive 2009/125/EC, (EU) 2019/1782, Case Color/Style: GlobTek Black, Wall Plug-in+Desktop Combination, Gigabit Power over Ethernet (IEEE802.3at PoE PSE) Power Supply AC Adaptor, Input Rating: 100-240V~, 50-60 Hz, IEC 60320/C8 w/ Wall Blades Option , Output Rating: 36W, 56.0V@0.64A, Output Configuration: N/A mm, N/A/ Cond, N/A, None, Ferrite: None, N/A, GT Cord # C0745, Pin Out: PoE injector wiring Data, Data+Power, RJ45 x 2, Blades/Input Cord: (Order Separately), Approvals: CB 62368; Patent US9838207B2; EAC; UKCA; Conforms to 62368-1; S-Mark 60950; ETL; CCC; Morocco; S-Mark 62368; IRAM; PSE; CB 60335; CE; WEEE; China RoHS; RoHS; Double Insulation; Level VI; Patent US9838207B2;</p>
	<p>Model No. GT-96300-3656-R2-AP</p>
	<p>Part No./Ordering No. GT-96300-3656-R2-AP</p>
	<p>Rev B</p>

## PACKAGING

Packing Spec P/N	Standard DT, Cellular packaging
Box Qty	36
Gift Box Size (mm)	Egg Crate
Gift Box Color	White
Master Carton Size (mm)	442 x 330 x 275
Master Carton Cubic Volume (m <sup>3</sup> )	0.04
Master GW (Kg)	kg
BLADES INCLUDED	None: (Order Separately)
BLADE/CORD INSTALLED	None: (Order Separately)
USER MANUAL*	
USER MANUAL WEB LINK	

\* This specification sheet is considered the user manual for all applications. It is expected that the buyer of this product will use it to formulate their own user manual for their end product and a user manual specifically for the power adapter is not usually required. If a user manual is not specifically listed above then none will be provided with this unit.

If specific packaging is required, this section must specify all requirements and note "no exceptions". If this section does not specify packaging, it is subject to change without notice at GlobTek's discretion.

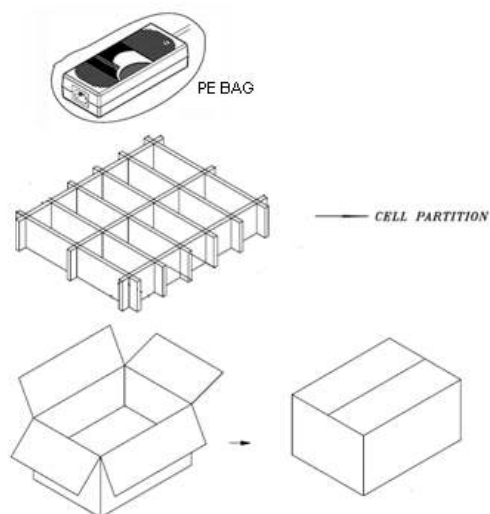

### PROPRIETARY INFORMATION

<p>GlobTek, Inc.  www.globtek.com  186 Veterans Drive,  Northvale, NJ 07647  Tel. (201) 784-1000  Fax (201) 784-0111</p>	<p>Drawing Title: GT-96300-3656-R2-AP, PoE, Active Power Injector, Efficiency Level: USA DOE Level VI / Eco-design Directive 2009/125/EC, (EU) 2019/1782, Case Color/Style: GlobTek Black, Wall Plug-in+Desktop Combination, Gigabit Power over Ethernet (IEEE802.3at PoE PSE) Power Supply AC Adaptor, Input Rating: 100-240V~, 50-60 Hz, IEC 60320/C8 w/ Wall Blades Option , Output Rating: 36W, 56.0V@0.64A, Output Configuration: N/A mm, N/A/ Cond, N/A, None, Ferrite: None, N/A, GT Cord # C0745, Pin Out: PoE injector wiring Data, Data+Power, RJ45 x 2, Blades/Input Cord: (Order Separately), Approvals: CB 62368; Patent US9838207B2; EAC; UKCA; Conforms to 62368-1; S-Mark 60950; ETL; CCC; Morocco; S-Mark 62368; IRAM; PSE; CB 60335; CE; WEEE; China RoHS; RoHS; Double Insulation; Level VI; Patent US9838207B2;</p>
	<p>Model No. GT-96300-3656-R2-AP</p>
	<p>Part No./Ordering No. GT-96300-3656-R2-AP</p>
	<p>Rev B</p>

**INSTRUCTIONS TO THE OEM SYSTEMS ENGINEER**

It is the responsibility of the OEM systems engineer to provide the end system user instructions and warnings for the use of this product in the end system.

If an input cord is required for this product, AC Mains voltage should be provided to the power supply by a power supply cord approved to the national standards of the country in which it will be used.

This product is not designed to be repaired. No serviceable parts inside. A blown internal fuse is an indication of catastrophic failure of circuit component(s). If a Failure Analysis is required for a failed power supply/battery charger, please return the damaged unit to GlobTek for an accurate determination of the root cause of the failure.

EMC Compliance of the complete OEM product, including the GlobTek power supply/battery charger needs to be verified by the OEM systems engineer.

**INSTRUCTION SHEET**

N/A

<p>GlobTek, Inc.  www.globtek.com  186 Veterans Drive,  Northvale, NJ 07647  Tel. (201) 784-1000  Fax (201) 784-0111</p>	<p>Drawing Title: GT-96300-3656-R2-AP, PoE, Active Power Injector, Efficiency Level: USA DOE Level VI / Eco-design Directive 2009/125/EC, (EU) 2019/1782, Case Color/Style: GlobTek Black, Wall Plug-in+Desktop Combination, Gigabit Power over Ethernet (IEEE802.3at PoE PSE) Power Supply AC Adaptor, Input Rating: 100-240V~, 50-60 Hz, IEC 60320/C8 w/ Wall Blades Option , Output Rating: 36W, 56.0V@0.64A, Output Configuration: N/A mm, N/A/ Cond, N/A, None, Ferrite: None, N/A, GT Cord # C0745, Pin Out: PoE injector wiring Data, Data+Power, RJ45 x 2, Blades/Input Cord: (Order Separately), Approvals: CB 62368; Patent US9838207B2; EAC; UKCA; Conforms to 62368-1; S-Mark 60950; ETL; CCC; Morocco; S-Mark 62368; IRAM; PSE; CB 60335; CE; WEEE; China RoHS; RoHS; Double Insulation; Level VI; Patent US9838207B2;</p>
	<p>Model No. GT-96300-3656-R2-AP</p>
	<p>Part No./Ordering No. GT-96300-3656-R2-AP</p>
	<p>Rev B</p>

