

TWTD Series – Full Size NEMA Pushbuttons



TWTD Series: Heavy duty switches built to last

Key features:

- Variety of button sizes up to 2 9/16" (65mm)
- Rugged construction includes chrome plated zinc locking ring die cast zinc mounting threads, screw mounted contact blocks
- LED or incandescent illumination
- Transformer or full voltage
- Transparent contact windows
- Slow make, double break self-cleaning contacts
- Modular construction for maximum flexibility
- Double nickel plated terminal screws
- Available assembled or as sub-components
- Type 4x and IP65 watertight/oiltight panel
- Large M3.5 screw terminals with captive sems plate

The rugged series of TWTD switches offers both variety and durability in an attractive design.

With button sizes up to 2 9/16" (65mm), chrome plated zinc locking rings, die cast zinc mounting threads, steel anti-rotation rings, and self cleaning contacts, the TWTDs are here to stay.

The TWTD series also offers either LED or incandescent illumination in full voltage and transformer models.

Transparent contact windows allow the viewing of IDEC's self cleaning slow-make/slow-break contacts.

Regardless of your switching needs, the TWTD series provides the kind of long lasting, industrial strength quality you've come to expect from IDEC.



Specifications

| | |
|---------------------------------------------|----------------------------------------------------------------------------------------------------------------------------------------------------------------------------------------------------------------------------------------------------------------------------------------------------------------------------------------------------------------------------------------------------------------------------------------------------------------------------------------------------------------------------------------------------------------------------------------------------------------------------------------------------------------------------------------------------------------------------------------------------------------------|
| Conforming to Standards | EN60947-1, EN60947-5-1, VDE0660-200, UL508, CSA C22-2 No.14 |
| Approvals | CSA: pushbuttons and selector switches: A600 pilot lights and illuminated pushbuttons, direct supply pilot lights and illuminated pushbuttons with integral transformer (100/110, 115, 120, 200/220, 230, 240, 380, 400/440, 480V) UL: pushbuttons and selector switches: A600 pilot lights and illuminated pushbuttons, direct supply pilot lights and illuminated pushbuttons with integral transformer (100/110, 115, 120, 200/220, 230, 240, 380, 400/440, 480V) TÜV: pushbuttons and selector switches: A600-P600 (NO, NC)/Q600 (NO-EM, NC-LB) pilot lights and illuminated pushbuttons, direct supply pilot lights and illuminated pushbuttons with integral transformer (100/110, 115, 120, 200/220, 230, 240, 380, 400/440, 480V) |
| Operating Temperature | Operation: -25 to +50°C (without freezing) Storage: -40 to +70°C (without freezing) |
| Vibration Resistance | 10 to 55Hz, 98m/sec ² (10g) conforming to IEC6068-2-6 |
| Shock Resistance | 980m/sec ² (100g) conforming to IEC6068-2-7 |
| Electric Shock Protection | Class 0 conforming to IEC60536 |
| Degree of Protection | IP65 (from front of the panel) (conforming to IEC60529) IP54 (key switches) Type 1, 2, 3, 3R, 3S, 4, 4X, 5, 12, 13 (conforming to NEMA ICS6-110) |
| Mechanical Life | Momentary pushbuttons: 5,000,000 (900 operations per hour) All other switches: 500,000 |
| Pollution Degree (conforming to IEC60947-1) | 3 for switches not using a transformer 2 for switches using a transformer |

Mechanical-Electrical Specifications

| | |
|------------------------------------|---------------------------------------------------------------------------------------------------------------------------------------------------------------------------|
| Rated Operational Characteristics | AC-15: A600 or Ue = 250V, Ie = 3A (NO, NC, NO-EM, NC-LB) DC-13: P600 or Ue = 125V, Ie = 1.1A (NO, NC) DC-13: Q600 or Ue = 125V, Ie = 0.9A (NO-EM, NC-LB) |
| Rated Insulation Voltage | 600V |
| Rated Switching Overvoltage | Less than 4kV, conforming to IEC60947-1 |
| Rated Impulse Withstanding Voltage | 4kV for contact circuit 2.5kV for lamp circuit |
| Rated Thermal Current | 10 Amp |
| Minimum Switching Capacity | 5 mA at 3V AC/DC |
| Contact Operation | Slow break NC or NO, self-cleaning |
| Operating Force | Flush and extended pushbuttons—with 1NO or 1NC contact: 6.2±2N (momentary), 7.0±2N (maintained) Additional contacts—1NO or 1NC: +3.2N (momentary), + 3.3N (maintained) |
| Terminal Referencing | Conforming to CENELEC EN50005 |
| Recommended Terminal Torque | 0.8 N m (7.1 in lb.) |
| External Short-Circuit Protection | 10A 250V fuse conforming to IEC60269-1 |
| Applicable Wire Size | Minimum 1 x 22 AWG, max. 2 x 14 AWG or 1 x 12 AWG |
| Contact Resistance | Initial contact resistance of 50mΩ or less |
| Contact Gap | 4mm (NO and NC) 2mm (NO-EM and NC-LB) |
| Lamp Ratings | Incandescent: 1 W LEDs: 6V: 17mA, 12V: 11mA, 24V: 11mA, / 120, 240V: 10mA |
| Maximum Inrush Current | 40 A (40 msec) |
| Contact Material | Silver |

Contact Ratings

| Contact Ratings by Utilization Category IEC 60947-5-1 | | AC-15 (A600) | | | | | | |
|-------------------------------------------------------|-------------|------------------------------------------------------|-----|-----|-----|------|-----------|---|
| | | DC-13 (P600) | | | | | | |
| Contact Ratings by Utilization Category | | | | | | | | |
| Operational Voltage | | | 24V | 48V | 50V | 110V | 220V 440V | |
| Operation Current | AC 50/60 Hz | AC-12 Control of resistive loads & solid state loads | 10A | — | 10A | 10A | 6A 2A | |
| | | AC-15 Control of electromagnetic loads (> 72VA) | 10A | — | 7A | 5A | 3A 1A | |
| | DC | DC-12 Control of resistive loads & solid state loads | 8A | 5A | — | 2.2A | 1.1A | — |
| | | DC-13 Control of electromagnets | 5A | 2A | — | 1.1A | 0.6A | — |

Switches & Pilot Devices

Signaling Lights

Relays & Sockets

Timers

Contactors

Terminal Blocks

Circuit Breakers

Non-Illuminated Pushbuttons (Assembled)



Assembled Pushbuttons

A B () D 1 10 N - R

| | |
|----------------------------------------------------------------------------------------------------------------------------------------------------------------------------------------------------------------------------------------------------------------------------------|------------------------------------------------------------------------------------------------------------------------------------------------------------------------------------------------------------------------------------------------------------------------------------------------------------------------------------------------|
| <p>Function</p> <p>B: Momentary O: Maintained V: Pushlock Turn Reset Y: Push-Pull</p> <p>Bezel Shape</p> <p>Blank: Octagonal F: Full Shroud G: Mushroom Shroud P: Neoprene Boot</p> <p>Series Designation</p> <p>D: TWTD Series</p> | <p>Button Color</p> <p>B: Black G: Green W: White R: Red S: Blue Y: Yellow</p> <p>Contact Arrangement</p> <p>10: 1NO 01: 1NC 20: 2NO 02: 2NC 11: 1NO-1NC 22: 2NO-2NC</p> <p>Button Shape</p> <p>1: Flush 2: Extended 3: Mushroom ø 40mm 4: Jumbo Mushroom ø 65mm</p> |
|----------------------------------------------------------------------------------------------------------------------------------------------------------------------------------------------------------------------------------------------------------------------------------|------------------------------------------------------------------------------------------------------------------------------------------------------------------------------------------------------------------------------------------------------------------------------------------------------------------------------------------------|

1. Use only when interpreting part numbers. Do not use for developing part numbers.
2. Custom contact configurations available, contact IDEC for details.

Non-Illuminated Pushbuttons (Assembled)

Non-Illuminated Pushbuttons

| Style | Contacts | Momentary | Maintained |
|------------------------------------------------|----------|------------|------------|
| Flush | 1NO | ABD110N-⓪ | AOD110N-⓪ |
| | 1NC | ABD101N-⓪ | AOD101N-⓪ |
| | 1NO-1NC | ABD111N-⓪ | AOD111N-⓪ |
| | 2NO | ABD120N-⓪ | AOD120N-⓪ |
| | 2NC | ABD102N-⓪ | AOD102N-⓪ |
| Extended | 1NO | ABD210N-⓪ | AOD210N-⓪ |
| | 1NC | ABD201N-⓪ | AOD201N-⓪ |
| | 1NO-1NC | ABD211N-⓪ | AOD211N-⓪ |
| | 2NO | ABD220N-⓪ | AOD220N-⓪ |
| | 2NC | ABD202N-⓪ | AOD202N-⓪ |
| Extended with Neoprene Boot* | 1NO | ABPD210N-⓪ | AOPD210N-⓪ |
| | 1NC | ABPD201N-⓪ | AOPD201N-⓪ |
| | 1NO-1NC | ABPD211N-⓪ | AOPD211N-⓪ |
| | 2NO | ABPD220N-⓪ | AOPD220N-⓪ |
| | 2NC | ABPD202N-⓪ | AOPD202N-⓪ |
| Recessed | 1NO | ABFD110N-⓪ | AOFD110N-⓪ |
| | 1NC | ABFD101N-⓪ | AOFD101N-⓪ |
| | 1NO-1NC | ABFD111N-⓪ | AOFD111N-⓪ |
| | 2NO | ABFD120N-⓪ | AOFD120N-⓪ |
| | 2NC | ABFD102N-⓪ | AOFD102N-⓪ |
| Extended with Full Shroud | 1NO | ABFD210N-⓪ | AOFD210N-⓪ |
| | 1NC | ABFD201N-⓪ | AOFD201N-⓪ |
| | 1NO-1NC | ABFD211N-⓪ | AOFD211N-⓪ |
| | 2NO | ABFD220N-⓪ | AOFD220N-⓪ |
| | 2NC | ABFD202N-⓪ | AOFD202N-⓪ |
| ø 40mm Mushroom Head | 1NO | ABD310N-⓪ | AOD310N-⓪ |
| | 1NC | ABD301N-⓪ | AOD301N-⓪ |
| | 1NO-1NC | ABD311N-⓪ | AOD311N-⓪ |
| | 2NO | ABD320N-⓪ | AOD320N-⓪ |
| | 2NC | ABD302N-⓪ | AOD302N-⓪ |
| ø 40mm Mushroom Head with Full Shroud | 1NO | ABGD310N-⓪ | AOGD310N-⓪ |
| | 1NC | ABGD301N-⓪ | AOGD301N-⓪ |
| | 1NO-1NC | ABGD311N-⓪ | AOGD311N-⓪ |
| | 2NO | ABGD320N-⓪ | AOGD320N-⓪ |
| | 2NC | ABGD302N-⓪ | AOGD302N-⓪ |
| ø 65mm Jumbo Mushroom Head | 1NO | ABD410N-⓪ | AOD410N-⓪ |
| | 1NC | ABD401N-⓪ | AOD401N-⓪ |
| | 1NO-1NC | ABD411N-⓪ | AOD411N-⓪ |
| | 2NO | ABD420N-⓪ | AOD420N-⓪ |
| | 2NC | ABD402N-⓪ | AOD402N-⓪ |
| ø 65mm Jumbo Mushroom Head with Shallow Shroud | 1NO | ABGD410N-⓪ | AOGD410N-⓪ |
| | 1NC | ABGD401N-⓪ | AOGD401N-⓪ |
| | 1NO-1NC | ABGD411N-⓪ | AOGD411N-⓪ |
| | 2NO | ABGD420N-⓪ | AOGD420N-⓪ |
| | 2NC | ABGD402N-⓪ | AOGD402N-⓪ |
| ø 65mm Jumbo Mushroom Head With Deep Shroud | 1NO | ABFD410N-⓪ | AOFD410N-⓪ |
| | 1NC | ABFD401N-⓪ | AOFD401N-⓪ |
| | 1NO-1NC | ABFD411N-⓪ | AOFD411N-⓪ |
| | 2NO | ABFD420N-⓪ | AOFD420N-⓪ |
| | 2NC | ABFD402N-⓪ | AOFD402N-⓪ |

⓪ Button Color Codes

| Color | Code |
|--------|------|
| Black | B |
| Green | G |
| Red | R |
| Blue | S |
| Yellow | Y |
| White | W |



- 65mm Jumbo mushroom not available in white.
- Neoprene boot is not available in blue or white.



- In place of ⓪, specify the Button Color Code.
- For sub-assembly part numbers, see next page.
- *Neoprene boot available only in Black (B), Green (G), Red (R) and Yellow (Y).

Non-Illuminated Pushbuttons (Sub-Assembled)

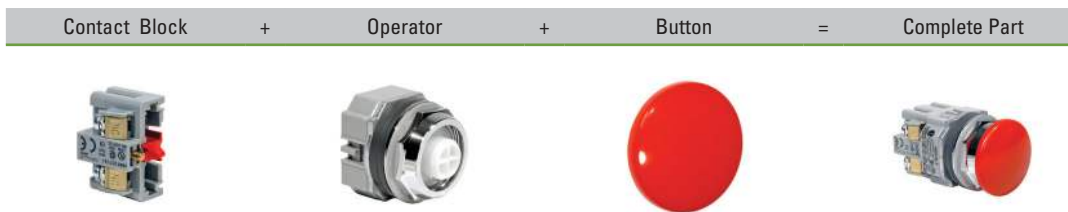

Operators

| Style | Image | Part Number | |
|-------------------------------------------|-------|-------------|------------|
| | | Momentary | Maintained |
| Flush/Extended | | ABD-100 | AOD-100 |
| Extended with Full Shroud | | ABFD-200 | AOFD-200 |
| ø 40mm Mushroom/ø 65mm Jumbo Mushroom | | ABD-300 | AOD-300 |
| ø 40mm Mushroom with Full Shroud | | ABGD-300 | AOGD-300 |
| ø 65mm Jumbo Mushroom with Shallow Shroud | | ABGD-400 | AOGD-400 |
| ø 65mm Jumbo Mushroom with Deep Shroud | | ABFD-400 | AOFD-400 |

Buttons and Lenses

| Style | Image | Part Number |
|-----------------------|-------|-------------|
| Flush | | ABD1BN-⓪ |
| Extended | | ABD2BN-⓪ |
| ø 40mm Mushroom | | ABD3BN-⓪ |
| ø 65mm Jumbo Mushroom | | ABD4BN-⓪ |

In place of ⓪, specify the Button Color Code. (See table previous page)

Contact Blocks

| Style | Image | Part Number | |
|-------------------|-------|-----------------------|-----------------------|
| | | 1NO | 1NC |
| All Control Units | | BST-010 | BST-001 |
| | | BST-010S (early make) | BST-001S (late break) |
| Dummy Block | | BST-D | |

- 1. Dummy blocks (no contacts) are used with an odd number of contact blocks.
- 2. Combining BST-010S and BST-001S result in overlapping contacts (remain on, or closed, when switch is moved between two positions).

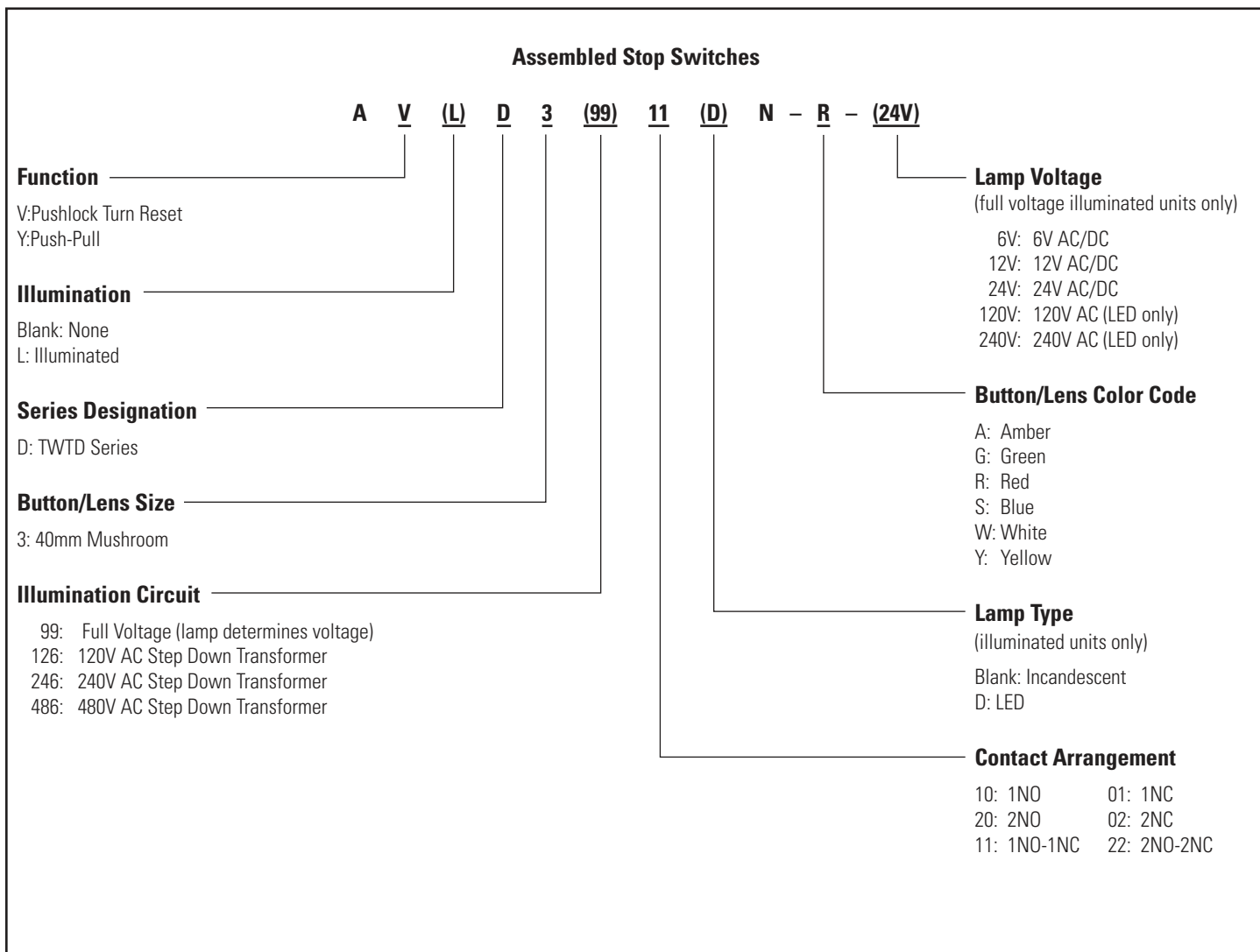

Stop Switches (Assembled)



1. Use only when interpreting part numbers. Do not use for developing part numbers.
2. Custom contact configurations available, contact IDEC for details.

Stop Switches (Assembled)

Stop Switches

| Style | Contacts | Part Number |
|------------------------------------------------------------------------------------------------------------------------------------------------|-------------------------------------|--------------------------------------------------------------------|
| ø 40mm Pushlock Turn Reset  Non-Illuminated | 1NO 1NC 1NO-1NC 2NO 2NC | AVD310N-R* AVD301N-R* AVD311N-R* AVD320N-R* AVD302N-R* |
| ø 40mm Illuminated Pushlock Turn Reset  Full Voltage | 1NO-1NC 2NO 2NC | AVLD39911ⓈN-R-Ⓢ* AVLD39920ⓈN-R-Ⓢ* AVLD39902ⓈN-R-Ⓢ* |
| ø 40mm Push-Pull  Non-Illuminated | 1NO 1NC 1NO-1NC 2NO 2NC | AYD310N-Ⓢ AYD301N-Ⓢ AYD311N-Ⓢ AYD320N-Ⓢ AYD302N-Ⓢ |
| ø 40mm Push-Pull  Full Voltage | 1NO-1NC 2NO 2NC | AYLD39911ⓈN-Ⓢ-Ⓢ** AYLD39920ⓈN-Ⓢ-Ⓢ** AYLD39902ⓈN-Ⓢ-Ⓢ** |
| ø 40mm Push-Pull  Transformer | 1NO-1NC 2NO 2NC | AYLD3Ⓢ 11ⓈN-Ⓢ** AYLD3Ⓢ 20ⓈN-Ⓢ** AYLD3Ⓢ 02ⓈN-Ⓢ** |
| ø 40mm Momentary Push-Pull (3-position)  Full Voltage | 1NO-1NC 1NC-1LB† | AYLD229911ⓈN-Ⓢ-Ⓢ -TK962 AYLD229902SⓈN-Ⓢ-Ⓢ-TK962 |
| ø 40mm Momentary Push-Pull (3-position)  Transformer | 1NO-1NC 1NC-1LB† | AYLD22Ⓢ 11ⓈN-Ⓢ-TK962 AYLD22Ⓢ 02SⓈN-Ⓢ-TK962 |

Unibody E-Stops

| Style | Contacts | Part Number |
|-------------------------------------------------------------------------------------------------------------------------------------------------------|----------------|----------------------------------------|
| ø 40mm Pushlock Turn Reset (available in Red only)  | 1NO-1NC 2NC | HN1E-BV4F11-R* HN1E-BV4F02-R* |
| Illuminated ø 40mm Pushlock Turn Reset (available in Red only)  | 1NO-1NC 2NC | HN1E-LV4F11QⓈ-R-Ⓢ HN1E-LV4F02QⓈ-R-Ⓢ |

3 Position Push-Pull†

| Contact | Push | Center | Pull |
|------------------|------|--------|------|
| NC (BST-001) | 0 | 0 | X |
| NC-LB (BST-001S) | 0 | X | X |
| NO (BST-010) | X | 0 | 0 |
| NO-EM (BST-010S) | X | X | 0 |

① Button Color Codes

| Color | Code |
|--------|------|
| Black | B |
| Green | G |
| Red | R |
| Blue | S |
| Yellow | Y |

Ⓢ LED/Lens Color Codes

| Color | Code |
|-------|------|
| Amber | A |
| Green | G |
| Red | R |
| Blue | S |
| White | W |

③ Full Voltage Codes

| Voltage | Code |
|-----------|-----------------|
| 6V AC/DC | 6V |
| 12V AC/DC | 12V |
| 24V AC/DC | 24V |
| 120V AC | 120V |
| 240V AC | 240V (LED only) |

Ⓢ Transformer Voltage Codes

| Voltage | Code |
|---------|------|
| 120VAC | 126 |
| 240VAC | 246 |
| 480VAC | 486 |



Transformers step down to 6V.

⑤ Lamp Type Codes

| Lamp | Code |
|--------------|-------|
| Incandescent | Blank |
| LED | D |

- In place of Ⓢ, specify the button color code
- In place of Ⓢ, specify the lens color code.
- In place of Ⓢ, specify the Full Voltage (lamp voltage) Code.
- In place of Ⓢ, specify the transformer voltage code.
- In place of Ⓢ, specify the Lamp Type code.
- With single unit construction, the positive action contacts are integrated in the body of the switch. This provides an extra degree of safety and reliability for critical emergency stop functions.
- HN1E series E-stops comply with the IEC "E-Stop Addendum to the Low Voltage Directive," this includes "tamper proof" operation whereby a change of contact state is not possible by "teasing" or "floating" the operator.
- 3 position push-pull available in spring return to center only.
- *Available in red only.
- **Not available in blue.
- †The most common configuration for motor starting applications.
- ‡For sub-assembly part numbers, see next page.
- §For nameplates and accessories, see page 744 and page 742.
- ¶For dimensions, see page 747.

Stop Switches (Sub-Assembled)







* Not required for full voltage units (full voltage clips used instead).

Operators



| Style | Part Number |
|----------------------------------------------------------------------------------------------------------------------------|------------------------|
|  ø40mm Pushlock Turn Reset | AVD-300 |
|  Illuminated ø40mm Pushlock Turn Reset | AVLD3-0600N |
|  ø40mm Push-Pull | AYD-3100 |
|  Illuminated ø 40mm Push-Pull | 2 pos AYLD-0600 |
| | 3 pos AYLD22TK962-0B01 |

Buttons and Lenses

| Style | Part Number |
|-----------------------------------------------------------------------------------------------------------------------------------------------------------------|-----------------|
|  Button for Pushlock Turn Reset Stop Switches (ø40mm, red only) | AVN3B-R |
|  Lens for Illuminated Pushlock Turn Reset Stop Switches (ø40mm, red only) | AVLN3LU-R |
|  Button for Push-Pull Stop Switches (ø40mm) | AYD3BN-① |
|  Lens for Illuminated Push-Pull Stop Switches (ø40mm) | 2 pos* AYLD3L-② |
| | 3 pos AYLD2L-② |

- 1. In place of ①, specify the Button Color Code. (See table below)
- 2. In place of ②, specify the LED Color Code.
- 3. *Not available in blue.

Lamps

| Style | Voltage | Part Number |
|---------------------------------------------------------------------------------------------------|-----------|-------------|
|  LED | 6V AC/DC | LSTD-6② |
| | 12V AC/DC | LSTD-1② |
| | 24V AC/DC | LSTD-2② |
| | 120V AC | LSTD-H2② |
| | 240V AC | LSTD-M4② |
|  Incandescent | 6V AC/DC | IS-6 |
| | 12V AC/DC | IS-12 |
| | 24V AC/DC | IS-24 |
| | 120V AC | L-120L |

- 1. In place of ②, specify the LED color code.
- 2. The LED contains a current-limiting resistor and a protection diode.

① Button Color Codes

| Color | Code |
|--------|------|
| Black | B |
| Green | G |
| Red | R |
| Blue | S |
| Yellow | Y |

② LED Color Codes

| Color | Code |
|-------|------|
| Amber | A |
| Green | G |
| Red | R |
| Blue | S |
| White | W |

Contact Blocks

| Style | Part Number | |
|------------------------------------------------------------------------------------------------------------|-----------------------|-----------------------|
| | 1NO | 1NC |
|  All Control Units | BST-010 | BST-001 |
| | BST-010S (early make) | BST-001S (late break) |
| Dummy Block | BST-D | |

- 1. Dummy blocks (no contacts) are used with an odd number of contact blocks.
- 2. Combining BST-010S and BST-001S result in overlapping contacts.

Full Voltage Clips

| Primary Voltage (50/60Hz) | Part Number |
|----------------------------------------------------------------------------------------------------------------------------------------|-------------|
|  Full Voltage Clips (2 required for each unit) | APD-F |

Transformers

| Style | Primary Voltage (50/60Hz) | Part Number |
|-------------------------------------------------------------------------------------|---------------------------|-------------|
|  | 120V AC | TWD-0126 |
| | 240V AC | TWD-0246 |
| | 480V AC | TWD-0486 |

- 1. 6V secondary voltage (uses 6V lamp).

Pilot Lights (Assembled)



Assembled Pilot Lights

A P D 1 126 D N - R - ()

Function
P: Pilot Light

Series Designation
D: TWTD Series

Lens Shape
1: Dome

Rated Operational Voltage (Primary)
Transformer Type Full Voltage Type
126: 120V AC 99: Full Voltage
246: 240V AC
486: 480V AC



Lamp Voltage
(full voltage illuminated units only)
6V: 6V AC/DC
12V: 12V AC/DC
24V: 24V AC/DC
120V: 120V AC (LED only)
240V: 240V AC (LED only)

Lens Color Code
A: Amber
G: Green
R: Red
S: Blue
W: White
Y: Yellow

Lamp Type
Blank: Incandescent
D: LED

Use only when interpreting part numbers. Do not use for developing part numbers.

LED and Incandescent Pilot Lights

| Style | Operating Voltage | Part Number | |
|----------------------------------------------------------------------------------------------------------|-------------------|--------------|--------------|
| | | LED | Incandescent |
|  Transformer Dome | 120V AC | APD1126DN-② | APD1126N-② |
| | 240V AC | APD1246DN-② | APD1246N-② |
| | 480V AC | APD1486DN-② | APD1486N-② |
|  Full Voltage Dome | — | APD199DN-②-③ | APD199N-②-③ |

② Lens Color Codes

| Color | Code |
|--------|------|
| Amber | A |
| Green | G |
| Red | R |
| Blue | S |
| White | W |
| Yellow | Y |

③ Full Voltage Codes

| Voltage | Code |
|-----------|-----------------|
| 6V AC/DC | 6V |
| 12V AC/DC | 12V |
| 24V AC/DC | 24V |
| 120V AC | 120V |
| 240V AC | 240V (LED only) |

- 1. In place of ②, specify the Lens/LED Color Code.
- 2. In place of ③, specify the Full Voltage Code (lamp voltage).
- 3. Yellow pilot light comes with white LED.

Pilot Lights (Sub-Assembled)

Transformer* + Operator + Lamp + Lens = Complete Part



* Not required for full voltage units (full voltage clips used instead).

One Each from Left Column **plus** One Selection from Right Column

Operators

| Style | Part Number |
|-----------------------------------------------------------------------------------|-------------|
|  | APD-006 |
|  | APD-199 |

Full voltage operator comes with full voltage clips.

Lenses

| Style | Part Number |
|-------------------------------------------------------------------------------------|-------------|
|  | APN106LN-② |

1. In place of ②, specify the Lens Color Code.
2. LED and incandescent lenses differ in shade only. Some colors have only one shade.

Lamps

| Style | Voltage | Part Number |
|-------------------------------------------------------------------------------------|-----------|-------------|
|  | 6V AC/DC | LSTD-6② |
| | 12V AC/DC | LSTD-1② |
| | 24V AC/DC | LSTD-2② |
| | 120V AC | LSTD-H2② |
| | 240V AC | LSTD-M4② |
|  | 6V AC/DC | IS-6 |
| | 12V AC/DC | IS-12 |
| | 24V AC/DC | IS-24 |
| | 120V AC | L-120L |

1. In place of ②, specify the LED color code.
2. The LED contains a current-limiting resistor and a protection diode.

Full Voltage Clips

| Primary Voltage (50/60Hz) | Part Number |
|-------------------------------------------------------------------------------------|-------------|
|  | APD-F |

Required for all full voltage models. Two pieces each.

Transformers

| Style | Primary Voltage (50/60Hz) | Part Number |
|-------------------------------------------------------------------------------------|---------------------------|-------------|
|  | 120V AC | TWD-0126 |
| | 240V AC | TWD-0246 |
| | 480V AC | TWD-0486 |

6V secondary voltage (use 6V lamp).

② LED/Lens Color Codes

| Color | Code |
|--------|------|
| Amber | A |
| Green | G |
| Red | R |
| Blue | S |
| White | W |
| Yellow | Y |

Yellow lens only. Yellow LED not available, use white LED.

Illuminated Pushbuttons (Assembled)

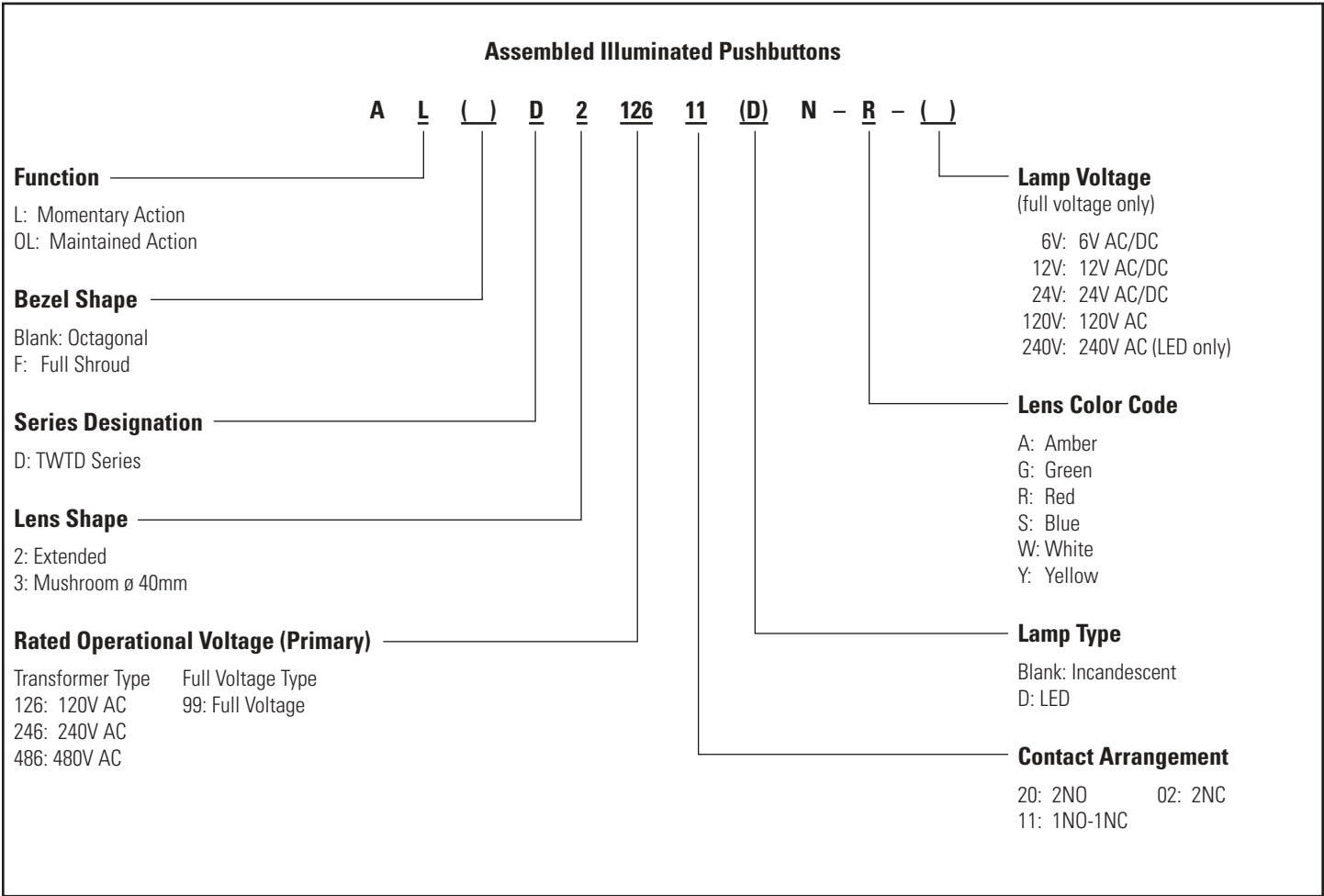

1. Use only when interpreting part numbers. Do not use for developing part numbers.
2. All transformers step down to 6V.

Illuminated Pushbuttons (Assembled)

Illuminated Pushbuttons

| Style | Contacts | Part Number | |
|---------------------------------------------------------------------------------------------------------------------|---------------------------------------|------------------------------------|--------------------------------------|
| | | Momentary | Maintained |
| Extended Lens  | Full Voltage 1NO-1NC 2NO 2NC | ALD29911ⓈN-Ⓜ-Ⓝ | AOLD29911ⓈN-Ⓜ-Ⓝ |
| | | ALD29920ⓈN-Ⓜ-Ⓝ ALD29902ⓈN-Ⓜ-Ⓝ | AOLD29920ⓈN-Ⓜ-Ⓝ AOLD29902ⓈN-Ⓜ-Ⓝ |
| Extended Lens with Full Shroud  | Full Voltage 1NO-1NC 2NO 2NC | ALFD29911ⓈN-Ⓜ-Ⓝ | AOLFD29911ⓈN-Ⓜ-Ⓝ |
| | | ALFD29920ⓈN-Ⓜ-Ⓝ ALFD29902ⓈN-Ⓜ-Ⓝ | AOLFD29920ⓈN-Ⓜ-Ⓝ AOLFD29902ⓈN-Ⓜ-Ⓝ |
| ø 40mm Mushroom Lens  | Full Voltage 1NO-1NC 2NO 2NC | ALD39911ⓈN-Ⓜ-Ⓝ | AOLD39911ⓈN-Ⓜ-Ⓝ |
| | | ALD39920ⓈN-Ⓜ-Ⓝ ALD39902ⓈN-Ⓜ-Ⓝ | AOLD39920ⓈN-Ⓜ-Ⓝ AOLD39902ⓈN-Ⓜ-Ⓝ |
| | Transformer 1NO-1NC 2NO 2NC | ALD2 Ⓜ 11ⓈN-Ⓜ | AOLD2 Ⓜ 11ⓈN-Ⓜ |
| | | ALD2 Ⓜ 20ⓈN-Ⓜ ALD2 Ⓜ 02ⓈN-Ⓜ | AOLD2 Ⓜ 20ⓈN-Ⓜ AOLD2 Ⓜ 02ⓈN-Ⓜ |
| | Transformer 1NO-1NC 2NO 2NC | ALFD2 Ⓜ 11ⓈN-Ⓜ | AOLFD2 Ⓜ 11ⓈN-Ⓜ |
| | | ALFD2 Ⓜ 20ⓈN-Ⓜ ALFD2 Ⓜ 02ⓈN-Ⓜ | AOLFD2 Ⓜ 20ⓈN-Ⓜ AOLFD2 Ⓜ 02ⓈN-Ⓜ |
| | Full Voltage 1NO-1NC 2NO 2NC | ALD39911ⓈN-Ⓜ-Ⓝ | AOLD39911ⓈN-Ⓜ-Ⓝ |
| | | ALD39920ⓈN-Ⓜ-Ⓝ ALD39902ⓈN-Ⓜ-Ⓝ | AOLD39920ⓈN-Ⓜ-Ⓝ AOLD39902ⓈN-Ⓜ-Ⓝ |
| | Transformer 1NO-1NC 2NO 2NC | ALD3 Ⓜ 11ⓈN-Ⓜ | AOLD3 Ⓜ 11ⓈN-Ⓜ |
| | | ALD3 Ⓜ 20ⓈN-Ⓜ ALD3 Ⓜ 02ⓈN-Ⓜ | AOLD3 Ⓜ 20ⓈN-Ⓜ AOLD3 Ⓜ 02ⓈN-Ⓜ |

② Lens Color Codes

| Color | Code |
|--------|------|
| Amber | A |
| Green | G |
| Red | R |
| Blue | S |
| White | W |
| Yellow | Y |

③ Full Voltage Codes

| Voltage | Code |
|-----------|-----------------|
| 6V AC/DC | 6V |
| 12V AC/DC | 12V |
| 24V AC/DC | 24V |
| 120V AC | 120V |
| 240V AC | 240V (LED only) |

④ Transformer Voltage Codes

| Voltage | Code |
|---------|------|
| 120VAC | 126 |
| 240VAC | 246 |
| 480VAC | 486 |

 6V secondary voltage (uses 6V lamp).

⑤ Lamp Type Codes

| Lamp | Code |
|--------------|-------|
| Incandescent | Blank |
| LED | D |

- 1. In place of Ⓜ, specify the Lens Color Code.
- 2. In place of Ⓝ, specify the Full Voltage Code (lamp voltage).
- 3. In place of Ⓜ, specify the Transformer Voltage Code.
- 4. In place of Ⓝ, specify the Lamp Type Code.
- 5. Light is independent of switch position.
- 6. Yellow pushbutton comes with white LED only.

Illuminated Pushbuttons (Sub-Assembled)



*Not required for full voltage types (full voltage types use APD-F full voltage clips).

Operators

| Style | Part Number | |
|---------------------------|-------------|------------|
| | Momentary | Maintained |
| Extended | ALD-0600 | AOLD-0600 |
| Extended with Full Shroud | ALFD-0600 | AOLFD-0600 |
| 40mm Mushroom | ALD-0600 | AOLD-0600 |

Lenses

| Style | Part Number |
|-----------------|-------------|
| Extended | ALN06LU-Ⓞ |
| ø 40mm Mushroom | ALN3LU-Ⓞ |

In place of Ⓞ, specify the Lens Color Code.

Full Voltage Clips

| Style | Part Number |
|-----------------------------------------------|-------------|
| Full Voltage Clips (2 required for each unit) | APD-F |

Required for all full voltage models.

Lamps

| Style | Voltage | Part Number |
|--------------|-----------|-------------|
| LED | 6V AC/DC | LSTD-6Ⓞ |
| | 12V AC/DC | LSTD-1Ⓞ |
| | 24V AC/DC | LSTD-2Ⓞ |
| | 120V AC | LSTD-H2Ⓞ |
| | 240V AC | LSTD-M4Ⓞ |
| Incandescent | 6V AC/DC | IS-6 |
| | 12V AC/DC | IS-12 |
| | 24V AC/DC | IS-24 |
| | 120V AC | L-120L |

Ⓞ LED/Lens Color Codes

| Color | Code |
|--------|------|
| Amber | A |
| Green | G |
| Red | R |
| Blue | S |
| White | W |
| Yellow | Y |

Yellow lens only. Yellow LED not available, use white LED.

- 1. In place of Ⓞ, specify the LED color code.
- 2. The LED contains a current-limiting resistor and a protection diode.

Contact Blocks

| Style | Part Number | |
|-------------------|-----------------------|-----------------------|
| | 1NO | 1NC |
| All Control Units | BST-010 | BST-001 |
| | BST-010S (early make) | BST-001S (late break) |
| Dummy Block | BST-D | |

- 1. Dummy blocks (no contacts) are used with an odd number of contact blocks.
- 2. Combining BST-010S and BST-001S result in overlapping contacts (remain on, or closed, when switch is moved between two positions).

Transformers

| Style | Primary Voltage (50/60Hz) | Part Number |
|--------------|---------------------------|-------------|
| Transformers | 120V AC | TWD-0126 |
| | 240V AC | TWD-0246 |
| | 480V AC | TWD-0486 |

6V secondary voltage (use 6V lamp).

Non-Illuminated Selector Switches (Assembled)



Assembled Selector Switches

A S D 2 () () 11 N - ()

Function

S: Selector Switch

Series Designation

D: TWTD Series

Number of Positions

2: 2-Position
3: 3-Position

Spring Return Action

Blank: Maintained
1: Spring return from Right
2: Spring return from Left
3: 2-Way spring return from Left and Right

Circuit Number

(See Circuit # column of Selector Switch Contact Arrangement Chart on beginning on page 739.)

Contact Arrangement Code

10: 1NO 01: 1NC
20: 2NO 02: 2NC
40: 4NO 04: 4NC
11: 1NO-1NC 22: 2NO-2NC

Operator Style Code

Blank: Knob Operator
L: Lever Operator
K: Key Operator

- 1. Use only when interpreting part numbers. Do not use for developing part numbers.
- 2. Custom key removal codes available. Please contact IDEC for details.

Non-Illuminated Selector Switches (Assembled)

Non-Illuminated 2-Position Selector Switches

| Style | | | | | Part Number | | |
|------------|------------------|-------------------|------------------|----------------------|---------------------------------------------|------------------------------------------------|------------------------------------------------|
| Contact | Mounting | Operator Position | | | Maintained | Spring Return from Right | Spring Return from Left |
| | | L | R | | | | |
| 1NO | 1 2 | 0 0 | X 0 | Knob Lever Key | ASD210N ASD2L10N ASD2K10N | ASD2110N ASD21L10N ASD21K10N | ASD2210N ASD22L10N ASD22K10N |
| 1NC | 1 2 | X 0 | 0 0 | Knob Lever Key | ASD201N-116 ASD2L01N-116 ASD2K01N-116 | ASD2101N-116 ASD21L01N-116 ASD21K01N-116 | ASD2201N-116 ASD22L01N-116 ASD22K01N-116 |
| 1NO 1NC | 1 2 | 0 X | X 0 | Knob Lever Key | ASD211N ASD2L11N ASD2K11N | ASD2111N ASD21L11N ASD21K11N | ASD2211N ASD22L11N ASD22K11N |
| 2NO | 1 2 | 0 0 | X X | Knob Lever Key | ASD220N ASD2L20N ASD2K20N | ASD2120N ASD21L20N ASD21K20N | ASD2220N ASD22L20N ASD22K20N |
| 2NC | 1 2 | X X | 0 0 | Knob Lever Key | ASD202N-104 ASD2L02N-104 ASD2K02N-104 | ASD2102N-104 ASD21L02N-104 ASD21K02N-104 | ASD2202N-104 ASD22L02N-104 ASD22K02N-104 |
| 2NO 2NC | 1 2 3 4 | 0 X 0 X | X 0 X 0 | Knob Lever Key | ASD222N ASD2L22N ASD2K22N | ASD2122N ASD21L22N ASD21K22N | ASD2222N ASD22L22N ASD22K22N |
| 2NO 2NC | 1 2 3 4 | 0 0 X X | X X 0 0 | Knob Lever Key | ASD222N-111 ASD2L22N-111 ASD2K22N-111 | ASD2122N-111 ASD21L22N-111 ASD21K22N-111 | ASD2222N-111 ASD22L22N-111 ASD22K22N-111 |



- The truth table indicates the operating position of contact block when the operator is switched to that position.
X = On (closed contacts) 0 = Off (open contacts)
X-X = Overlapping Contacts: Remain on (closed contacts) when switch is moved between these two positions.
- All knob and lever selector switches come in black. Other colors are available by ordering the knob or lever separately.
- Custom contact arrangements available, see page 739.

Non-Illuminated 3-Position Selector Switches

| Style | | | | | | Part Number | | | |
|------------|------------------|-------------------|------------------|------------------|----------------------|---------------------------------------------|------------------------------------------------|------------------------------------------------|------------------------------------------------|
| Contact | Mounting | Operator Position | | | | Maintained | Spring Return from Right | Spring Return from Left | Spring Return Two-Way |
| | | L | C | R | | | | | |
| 2NO | 1 2 | X 0 | 0 0 | 0 X | Knob Lever Key | ASD320N ASD3L20N ASD3K20N | ASD3120N ASD31L20N ASD31K20N | ASD3220N ASD32L20N ASD32K20N | ASD3320N ASD33L20N ASD33K20N |
| 2NC | 1 2 | 0 X | X X | X 0 | Knob Lever Key | ASD302N ASD3L02N ASD3K02N | ASD3102N ASD31L02N ASD31K02N | ASD3202N ASD32L02N ASD32K02N | ASD3302N ASD33L02N ASD33K02N |
| 2NO 2NC | 1 2 3 4 | X 0 0 X | 0 0 X X | 0 X X 0 | Knob Lever Key | ASD322N ASD3L22N ASD3K22N | ASD3122N ASD31L22N ASD31K22N | ASD3222N ASD32L22N ASD32K22N | ASD3322N ASD33L22N ASD33K22N |
| 2NO 2NC | 1 2 3 4 | X X 0 0 | 0 X X 0 | X 0 0 X | Knob Lever Key | ASD322N-309 ASD3L22N-309 ASD3K22N-309 | ASD3122N-309 ASD31L22N-309 ASD31K22N-309 | ASD3222N-309 ASD32L22N-309 ASD32K22N-309 | ASD3322N-309 ASD33L22N-309 ASD33K22N-309 |
| 2NO 2NC | 1 2 3 4 | 0 0 0 0 | X 0 X 0 | 0 X 0 X | Knob Lever Key | ASD322N-310 ASD3L22N-310 ASD3K22N-310 | ASD3122N-310 ASD31L22N-310 ASD31K22N-310 | ASD3222N-310 ASD32L22N-310 ASD32K22N-310 | ASD3322N-310 ASD33L22N-310 ASD33K22N-310 |
| 4NO | 1 2 3 4 | X 0 X 0 | 0 0 0 0 | 0 X 0 X | Knob Lever Key | ASD340N ASD3L40N ASD3K40N | ASD3140N ASD31L40N ASD31K40N | ASD3240N ASD32L40N ASD32K40N | ASD3340N ASD33L40N ASD33K40N |
| 4NC | 1 2 3 4 | 0 X 0 X | X X X X | X 0 X 0 | Knob Lever Key | ASD304N ASD3L04N ASD3K04N | ASD3104N ASD31L04N ASD31K04N | ASD3204N ASD32L04N ASD32K04N | ASD3304N ASD33L04N ASD33K04N |



Non-Illuminated Selector Switches (Sub-Assembled)

Contact Blocks + Operator + Knob or Lever* + Color Insert* = Complete Part†



- *Not needed with key type switches.
- *Knob type shown.

Operators

| Style | Position | Description | Part Number | |
|-------------------------------------------------------------------------------------------------|------------------------------------------------------------------|--------------------------------------------------------------------------------------------|--------------------------------------------------------------------|----------------------------------|
|  Knob/Lever | 2 | Maintained | ASD200 | |
| | | Spring return from right | ASD2100 | |
| | | Spring return from left | ASD2200 | |
| | 3 | Maintained, Cam 1 Maintained, Cam 2 | ASD300-1 | ASD300-2 |
| | | | Spring return from right, Cam 1 Spring return from right, Cam 2 | ASD3100-1 ASD3100-2 |
| | | Spring return from left, Cam 1 Spring return from left, Cam 2 | ASD3200-1 | ASD3200-2 |
| Spring return from left/right, Cam 1 Spring return from left/right, Cam 2 | | | ASD3300-1 | ASD3300-2 |
| | |  Key | 2 | Maintained |
| Spring return from right | | | | ASD21K00-RL |
| Spring return from left | ASD22K00 | | | |
| 3 | Maintained, Cam 1 Maintained, Cam 2 | | ASD3K00-1 | ASD3K00-2 |
| | | | Spring return from right, Cam 1 Spring return from right, Cam 2 | ASD31K00-1-RLC ASD31K00-2-RLC |
| | Spring return from left, Cam 1 Spring return from left, Cam 2 | | ASD32K00-1-RRC ASD32K00-2-RRC | |
| Spring return from left/right, Cam 1 Spring return from left/right, Cam 2 | | ASD33K00-1-RC ASD33K00-2-RC | | |

- Order knobs, levers, color inserts separately (see below).
- For key switches, keys are removable in all maintained positions. Other options available, contact IDEC for details.
- See page 741 "Operator Truth Tables" for details of difference between cams.

① Color Codes

| Knob/Lever Color | Code |
|------------------|------|
| Black | B |
| Blue | S |
| Green | G |
| Red | R |
| Yellow | Y |
| White | W |

- Knob/Lever not available in white.
- Color inserts not available in Black.
- Lever not available in yellow.

Handles and Inserts

| Style | Part Number |
|-----------------------------------------------------------------------------------------------------|-------------|
|  Knob | ASDHHY-⊙ |
|  Lever | ASDHHL-⊙* |
|  Color Insert | TW-HC1-⊙ |

- In place of ⊙, specify the Color Code.
*Not available in yellow.

Contact Blocks

| Style | Part Number | |
|------------------------------------------------------------------------------------------------------------|----------------------------------|----------------------------------|
| | 1NO | 1NC |
|  All Control Units | BST-010 BST-010S (early make) | BST-001 BST-001S (late break) |
| Dummy Block | BST-D | |

- Dummy blocks (no contacts) are used with an odd number of contact blocks.
- Combining BST-010S and BST-001S result in overlapping contacts (remain on, or closed, when switch is moved between two positions).

Illuminated Selector Switches (Assembled)



Assembled Illuminated Selector Switches

A SL D 2 (2) 99 11 D N - 111 - R - 24

Function

SL: Illuminated Selector Switch

Series Designation

D: TWTD series

Number of Positions

2: 2-Position
3: 3-Position

Spring Return Action

Blank: Maintained
1: Spring return from Right
2: Spring return from Left
3: Two-Way spring return from Left and Right

Rated Operational Voltage (Primary)

| | |
|------------------|-------------------|
| Transformer Type | Full Voltage Type |
| 126: 120V AC | 99: Full Voltage |
| 246: 240V AC | |
| 486: 480V AC | |

Contact Arrangement Code

| | |
|-------------|-------------|
| 20: 2NO | 02: 2NC |
| 40: 4NO | 04: 4NC |
| 11: 1NO-1NC | 22: 2NO-2NC |

Lamp Voltage

(Full Voltage Units Only)

6V: 6V AC/DC
12V: 12V AC/DC
24V: 24V AC/DC
120V: 120V AC
240V: 240V AC (LED only)

Lens Color Code

A: Amber
G: Green
R: Red
S: Blue
W: White
Y: Yellow

Circuit Code Number

See Circuit # column of Selector Switch Contact Arrangement Charts on page 739.

Lamp Type

Blank: Incandescent Lamp
D: LED Lamp

 Use only when interpreting part numbers. Do not use for developing part numbers.

Illuminated Selector Switches (Assembled)

Illuminated 2-Position Selector Switches

| Style | | | | | Part Number | | |
|------------|------------------|-------------------|------------------|--------------------------|------------------------------------------|--------------------------------------------|--------------------------------------------|
| Contact | Mounting | Operator Position | | Lamp Circuit Type | Maintained | Spring Return from Right | Spring Return from Left |
| | | L | R | | | | |
| 1NO 1NC | 1 2 | 0 X | X 0 | Transformer Full Voltage | ASLD2 ④11⑤N-② ASLD29911⑤N-②-③ | ASLD21 ④11⑤N-② ASLD219911⑤N-②-③ | ASLD22 ④11⑤N-② ASLD229911⑤N-②-③ |
| 2NO 2NC | 1 2 | 0 X | X 0 | | Transformer Full Voltage | ASLD2 ④20⑤N-② ASLD29920⑤N-②-③ | ASLD21 ④20⑤N-② ASLD219920⑤N-②-③ |
| 2NO 2NC | 1 2 | X X | 0 0 | Transformer Full Voltage | ASLD2 ④02⑤N-104-② ASLD29902⑤N-104-②-③ | ASLD21 ④02⑤N-104-② ASLD219902⑤N-104-②-③ | ASLD22 ④02⑤N-104-② ASLD229902⑤N-104-②-③ |
| 2NO 2NC | 1 2 3 4 | 0 X 0 X | X 0 X 0 | | Transformer Full Voltage | ASLD2 ④22⑤N-② ASLD29922⑤N-②-③ | ASLD21 ④22⑤N-② ASLD219922⑤N-②-③ |
| 2NO 2NC | 1 2 3 4 | 0 0 X X | X 0 0 0 | Transformer Full Voltage | ASLD2 ④22⑤N-111-② ASLD29922⑤N-111-②-③ | ASLD21 ④22⑤N-111-② ASLD219922⑤N-111-②-③ | ASLD22 ④22⑤N-111-② ASLD229922⑤N-111-②-③ |

② LED/Lens Color Codes

| Color | Code |
|--------|------|
| Amber | A |
| Green | G |
| Red | R |
| Blue | S |
| White | W |
| Yellow | Y |

③ Full Voltage Codes

| Voltage | Code |
|-----------|-----------------|
| 6V AC/DC | 6V |
| 12V AC/DC | 12V |
| 24V AC/DC | 24V |
| 120V AC | 120V |
| 240V AC | 240V (LED only) |

Illuminated 3-Position Selector Switches, Maintained and Spring Return

| Style | | | | | Part Number | | | | |
|------------|------------------|-------------------|------------------|------------------|--------------------------|-------------------------------------------|---------------------------------------------|---------------------------------------------|---------------------------------------------|
| Contact | Mounting | Operator Position | | | Lamp Circuit Type | Maintained | Spring Return From Right | Spring Return from Left | Spring Return Two-Way |
| | | L | C | R | | | | | |
| 2NO 2NC | 1 2 | X 0 | 0 0 | 0 X | Transformer Full Voltage | ASLD3 ④ 20⑤N-② ASLD39920⑤N-②-③ | ASLD31 ④ 20⑤N-② ASLD319920⑤N-②-③ | ASLD32 ④ 20⑤N-② ASLD329920⑤N-②-③ | ASLD33 ④ 20⑤N-② ASLD339920⑤N-②-③ |
| 2NO 2NC | 1 2 | 0 X | X X | 0 0 | | Transformer Full Voltage | ASLD3 ④ 02⑤N-② ASLD39902⑤N-②-③ | ASLD31 ④ 02⑤N-② ASLD319902⑤N-②-③ | ASLD32 ④ 02⑤N-② ASLD329902⑤N-②-③ |
| 2NO 2NC | 1 2 3 4 | X 0 0 X | 0 0 X X | 0 X 0 0 | Transformer Full Voltage | ASLD3 ④ 22⑤N-② ASLD39922⑤N-②-③ | ASLD31 ④ 22⑤N-② ASLD319922⑤N-②-③ | ASLD32 ④ 22⑤N-② ASLD329922⑤N-②-③ | ASLD33 ④ 22⑤N-② ASLD339922⑤N-②-③ |
| 2NO 2NC | 1 2 3 4 | X X 0 0 | 0 X X 0 | 0 0 X X | | Transformer Full Voltage | ASLD3 ④ 22⑤N-309-② ASLD39922⑤N-309-②-③ | ASLD31 ④ 22⑤N-309-② ASLD319922⑤N-309-②-③ | ASLD32 ④ 22⑤N-309-② ASLD329922⑤N-309-②-③ |
| 2NO 2NC | 1 2 3 4 | 0 0 0 0 | X 0 X 0 | 0 X 0 X | Transformer Full Voltage | ASLD3 ④ 22⑤N-310-② ASLD39922⑤N-310-②-③ | ASLD31 ④ 22⑤N-310-② ASLD319922⑤N-310-②-③ | ASLD32 ④ 22⑤N-310-② ASLD329922⑤N-310-②-③ | ASLD33 ④ 22⑤N-310-② ASLD339922⑤N-310-②-③ |
| 4NO | 1 2 3 4 | X 0 X 0 | 0 0 0 0 | 0 X 0 X | | Transformer Full Voltage | ASLD3 ④ 40⑤N-② ASLD39940⑤N-②-③ | ASLD31 ④ 40⑤N-② ASLD319940⑤N-②-③ | ASLD32 ④ 40⑤N-② ASLD329940⑤N-②-③ |
| 4NC | 1 2 3 4 | 0 X 0 X | X X X X | 0 0 0 0 | Transformer Full Voltage | ASLD3 ④ 04⑤N-② ASLD39904⑤N-②-③ | ASLD31 ④ 04⑤N-② ASLD319904⑤N-②-③ | ASLD32 ④ 04⑤N-② ASLD329904⑤N-②-③ | ASLD33 ④ 04⑤N-② ASLD339904⑤N-②-③ |

- In place of ②, specify the Lens/LED Color Code, in place of ③, specify the Full Voltage (lamp voltage) Code, in place of ④, specify the Transformer Voltage Code and in place of ⑤ specify the Lamp Type Code.
- The truth table indicates the operating position of contact block when the operator is switched to that position.
X = On (Closed Contacts) 0 = Off (Open Contacts)
X-X = Overlapping Contacts: Remain on (closed contacts) when switch is moved between these positions
- Yellow selector switch comes with white LED.

④ Transformer Voltage Codes

| Voltage | Code |
|---------|------|
| 120VAC | 126 |
| 240VAC | 246 |
| 480VAC | 486 |

Transformers step down to 6V (use 6V lamp).

⑤ Lamp Type Codes

| Lamp | Code |
|--------------|-------|
| Incandescent | Blank |
| LED | D |

Light is independent of switch position.

Illuminated Selector Switches (Sub-Assembled)



*Not required for full voltage units (use APD-F full voltage clips instead).

Operators

| Style | Position | Description | Part Number |
|--------------------------------------------------------------------------------------------|----------|----------------------------------------|------------------------|
|  Operator | 2 | Maintained | ASLD200 |
| | 3 | Maintained, Cam 1 Maintained, Cam 2 | ASLD300-1 ASLD300-2 |
| | 2 | Spring return from right | ASLD2100 |
| | | Spring return from left | ASLD2200 |
| | 3 | Spring return from right, Cam 1 | ASLD3100-1 |
| | | Spring return from right, Cam 2 | ASLD3100-2 |
| | | Spring return from left, Cam 1 | ASLD3200-1 |
| | | Spring return from left, Cam 2 | ASLD3200-2 |
| | | Spring return from left/right, Cam 1 | ASLD3300-1 |
| | | Spring return from left/right, Cam 2 | ASLD3300-2 |

Contact Blocks

| Style | Part Number | |
|-------------------------------------------------------------------------------------------------------|--------------------------|--------------------------|
| | 1NO | 1NC |
|  All Control Units | BST-010 | BST-001 |
| | BST-010S (early make) | BST-001S (late break) |
| Dummy Block | BST-D | |

- 1. Dummy blocks (no contacts) are used with an odd number of contact blocks.
- 2. Combining BST-010S and BST-001S result in overlapping contacts (remain on, or closed, when switch is moved between two positions).

Full Voltage Clips

| Style | Part Number |
|----------------------------------------------------------------------------------------------------------------------------------------|-------------|
|  Full Voltage Clips (2 required for each unit) | APD-F |

Required for all full voltage models.

Transformers

| Style | Primary Voltage (50/60Hz) | Part Number |
|---------------------------------------------------------------------------------------------------|---------------------------|-------------|
|  Transformers | 120V AC | TWD-0126 |
| | 240V AC | TWD-0246 |
| | 480V AC | TWD-0486 |

6V secondary voltage.

② LED/Lens Color Codes



| Color | Code | Color | Code |
|-------|------|--------|------|
| Amber | A | Blue | S |
| Green | G | White | W |
| Red | R | Yellow | Y |

Yellow lens only. Yellow LED not available, use white LED.

Lenses

| Style | Part Number |
|------------------------------------------------------------------------------------------|-------------|
|  Knob | ASLNHU-① |

Lamps

| Style | Voltage | Part Number |
|--------------------------------------------------------------------------------------------------|-----------|-------------|
|  LED | 6V AC/DC | LSTD-6② |
| | 12V AC/DC | LSTD-1② |
| | 24V AC/DC | LSTD-2② |
| | 120V AC | LSTD-H2② |
| | 240V AC | LSTD-M4② |
|  Incandescent | 6V AC/DC | IS-6 |
| | 12V AC/DC | IS-12 |
| | 24V AC/DC | IS-24 |
| | 120V AC | L-120L |

- 1. In place of ②, specify the LED color code.
- 2. The LED contains a current-limiting resistor and a protection diode.

Contact Arrangement Charts

How to Read Contact Arrangement Charts

To determine contact block mounting position, first make sure the selector switch is oriented as shown on the right

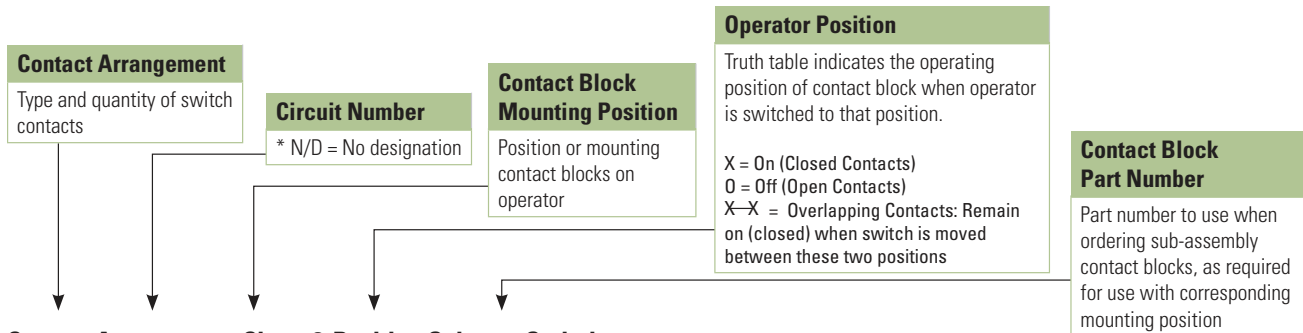

Contact Arrangement Chart: 2-Position Selector Switches

| Style | | Mounting Position | Operator Position | | Contact Block Part Number | Description | Operator Part Number | | |
|------------------|----------------|-------------------|-------------------|---------|---------------------------|-------------------|----------------------|--------------------------|-------------------------|
| Contact | Circuit Number | | L | R | | | Maintained | Spring Return from Right | Spring Return from Left |
| | | | | | | | | | |
| 1NO | N/D | 1 | O | X | BST-010 | Knob/Lever Key | ASD200 ASD2K00 | ASD2100 ASD21K00 | ASD2200 ASD22K00 |
| | | 2 | O | O | BST-D | Illuminated Knob | ASLD200 | ASLD2100 | ASLD2200 |
| 1NC | 116 | 1 | X | O | BST-001 | Knob/Lever Key | ASD200 ASD2K00 | ASD2100 ASD21K00 | ASD2200 ASD22K00 |
| | | 2 | O | O | BST-D | Illuminated Knob | ASLD200 | ASLD2100 | ASLD2200 |
| 1NO 1NC | N/D | 1 | O | X | BST-010 | Knob/Lever Key | ASD200 ASD2K00 | ASD2100 ASD21K00 | ASD2200 ASD22K00 |
| | | 2 | X | O | BST-001 | Illuminated Knob | ASLD200 | ASLD2100 | ASLD2200 |
| | 103 | 1 | X | O | BST-001 | Knob/Lever Key | ASD200 ASD2K00 | ASD2100 ASD21K00 | ASD2200 ASD22K00 |
| | | 2 | O | X | BST-010 | Illuminated Knob | ASLD200 | ASLD2100 | ASLD2200 |
| 1NO-EM 1NC-LB | 600 | 1 | O | X | BST-010S | Knob/Lever Key | ASD200 ASD2K00 | ASD2100 ASD21K00 | ASD2200 ASD22K00 |
| | | 2 | X | O | BST-001S | Illuminated Knob | ASLD200 | ASLD2100 | ASLD2200 |
| | 601 | 1 | X | O | BST-001S | Knob/Lever Key | ASD200 ASD2K00 | ASD2100 ASD21K00 | ASD2200 ASD22K00 |
| | | 2 | O | X | BST-010S | Illuminated Knob | ASLD200 | ASLD2100 | ASLD2200 |
| 2NO | N/D | 1 | O | X | BST-010 | Knob/Lever Key | ASD200 ASD2K00 | ASD2100 ASD21K00 | ASD2200 ASD22K00 |
| | | 2 | O | X | BST-010 | Illuminated Knob | ASLD200 | ASLD2100 | ASLD2200 |
| 2NC | 104 | 1 | X | O | BST-001 | Knob/Lever Key | ASD200 ASD2K00 | ASD2100 ASD21K00 | ASD2200 ASD22K00 |
| | | 2 | X | O | BST-001 | Illuminated Knob | ASLD200 | ASLD2100 | ASLD2200 |
| 2NO 2NC | N/D | 1 | O | X | BST-010 | Knob/Lever Key | ASD200 ASD2K00 | ASD2100 ASD21K00 | ASD2200 ASD22K00 |
| | | 2 | X | O | BST-001 | Illuminated Knob | ASLD200 | ASLD2100 | ASLD2200 |
| | | 3 | O | X | BST-010 | Knob/Lever Key | ASD200 ASD2K00 | ASD2100 ASD21K00 | ASD2200 ASD22K00 |
| | | 4 | X | O | BST-001 | Illuminated Knob | ASLD200 | ASLD2100 | ASLD2200 |
| | 110 | 1 | X | O | BST-001 | Knob/Lever Key | ASD200 ASD2K00 | ASD2100 ASD21K00 | ASD2200 ASD22K00 |
| | | 2 | O | X | BST-010 | Illuminated Knob | ASLD200 | ASLD2100 | ASLD2200 |
| | | 3 | X | O | BST-001 | Knob/Lever Key | ASD200 ASD2K00 | ASD2100 ASD21K00 | ASD2200 ASD22K00 |
| | | 4 | O | X | BST-010 | Illuminated Knob | ASLD200 | ASLD2100 | ASLD2200 |
| 111 | 1 | O | X | BST-010 | Knob/Lever Key | ASD200 ASD2K00 | ASD2100 ASD21K00 | ASD2200 ASD22K00 | |
| | 2 | O | X | BST-010 | Illuminated Knob | ASLD200 | ASLD2100 | ASLD2200 | |
| | 3 | X | O | BST-001 | Knob/Lever Key | ASD200 ASD2K00 | ASD2100 ASD21K00 | ASD2200 ASD22K00 | |
| | 4 | X | O | BST-001 | Illuminated Knob | ASLD200 | ASLD2100 | ASLD2200 | |
| 4NO | N/D | 1 | O | X | BST-010 | Knob/Lever Key | ASD200 ASD2K00 | ASD2100 ASD21K00 | ASD2200 ASD22K00 |
| | | 2 | O | X | BST-010 | Illuminated Knob | ASLD200 | ASLD2100 | ASLD2200 |
| | | 3 | O | X | BST-010 | Knob/Lever Key | ASD200 ASD2K00 | ASD2100 ASD21K00 | ASD2200 ASD22K00 |
| | | 4 | O | X | BST-010 | Illuminated Knob | ASLD200 | ASLD2100 | ASLD2200 |

Contact Arrangement Chart: 3-Position Selector Switches

| Contact | Circuit Number | Mounting Position | Operator Position | | | Contact Block Part Number | Description | Operator Part Number | | | |
|------------|----------------|-------------------|-------------------|---|---------|------------------------------------|------------------------------------|---------------------------------------|---------------------------------------|---------------------------------------|---------------------------------------|
| | | | L | C | R | | | Maintained | Spring Return from Right | Spring Return from Left | Two-Way |
| | | | | | | | | | | | |
| 1NO 1NC | 202 | 1 | X | 0 | 0 | BST-010 | Knob/Lever Key | ASD300-1 | ASD3100-1 | ASD3200-1 | ASD3300-1 |
| | | 2 | X | X | 0 | BST-001 | Illuminated Knob | ASD3K00-1 ASLD300-1 | ASD31K00-1 ASLD3100-1 | ASD32K00-1 ASLD3200-1 | ASD33K00-1 ASLD3300-1 |
| | 203 | 1 | 0 | X | X | BST-001 | Knob/Lever Key | ASD300-1 | ASD3100-1 | ASD3200-1 | ASD3300-1 |
| | | 2 | 0 | 0 | X | BST-010 | Illuminated Knob | ASD3K00-1 ASLD300-1 | ASD31K00-1 ASLD3100-1 | ASD32K00-1 ASLD3200-1 | ASD33K00-1 ASLD3300-1 |
| | 302 | 1 | X | 0 | X | BST-010 | Knob/Lever Key | ASD300-2 | ASD3100-2 | ASD3200-2 | ASD3300-2 |
| | | 2 | X | X | 0 | BST-001 | Illuminated Knob | ASD3K00-2 ASLD300-2 | ASD31K00-2 ASLD3100-2 | ASD32K00-2 ASLD3200-2 | ASD33K00-2 ASLD3300-2 |
| | 303 | 1 | 0 | X | 0 | BST-001 | Knob/Lever Key | ASD300-2 | ASD3100-2 | ASD3200-2 | ASD3300-2 |
| | | 2 | 0 | 0 | X | BST-010 | Illuminated Knob | ASD3K00-2 ASLD300-2 | ASD31K00-2 ASLD3100-2 | ASD32K00-2 ASLD3200-2 | ASD33K00-2 ASLD3300-2 |
| 2NO | N/D | 1 | X | 0 | 0 | BST-010 | Knob/Lever Key | ASD300-1 | ASD3100-1 | ASD3200-1 | ASD3300-1 |
| | | 2 | 0 | 0 | X | BST-010 | Illuminated Knob | ASD3K00-1 ASLD300-1 | ASD31K00-1 ASLD3100-1 | ASD32K00-1 ASLD3200-1 | ASD33K00-1 ASLD3300-1 |
| | 301 | 1 | X | 0 | X | BST-010 | Knob/Lever Key | ASD300-2 | ASD3100-2 | ASD3200-2 | ASD3300-2 |
| | | 2 | 0 | 0 | X | BST-010 | Illuminated Knob | ASD3K00-2 ASLD300-2 | ASD31K00-2 ASLD3100-2 | ASD32K00-2 ASLD3200-2 | ASD33K00-2 ASLD3300-2 |
| 2NC | 304 | 1 | 0 | X | 0 | BST-001 | Knob/Lever Key | ASD300-2 | ASD3100-2 | ASD3200-2 | ASD3300-2 |
| | | 2 | X | X | 0 | BST-001 | Illuminated Knob | ASD3K00-2 ASLD300-2 | ASD31K00-2 ASLD3100-2 | ASD32K00-2 ASLD3200-2 | ASD33K00-2 ASLD3300-2 |
| | N/D | 1 | 0 | X | X | BST-001 | Knob/Lever Key | ASD300-1 | ASD3100-1 | ASD3200-1 | ASD3300-1 |
| | | 2 | X | X | 0 | BST-001 | Illuminated Knob | ASD3K00-1 ASLD300-1 | ASD31K00-1 ASLD3100-1 | ASD32K00-1 ASLD3200-1 | ASD33K00-1 ASLD3300-1 |
| 2NO 2NC | N/D | 1 | X | 0 | 0 | BST-010 | Knob/Lever Key Illuminated Knob | ASD300-1 ASD3K00-1 ASLD300-1 | ASD3100-1 ASD31K00-1 ASLD3100-1 | ASD3200-1 ASD32K00-1 ASLD3200-1 | ASD3300-1 ASD33K00-1 ASLD3300-1 |
| | | 2 | 0 | 0 | X | BST-010 | | | | | |
| | | 3 | 0 | X | X | BST-001 | | | | | |
| | | 4 | X | X | 0 | BST-001 | | | | | |
| | 210 | 1 | 0 | X | X | BST-001 | Knob/Lever Key Illuminated Knob | ASD300-1 ASD3K00-1 ASLD300-1 | ASD3100-1 ASD31K00-1 ASLD3100-1 | ASD3200-1 ASD32K00-1 ASLD3200-1 | ASD3300-1 ASD33K00-1 ASLD3300-1 |
| | | 2 | 0 | 0 | X | BST-010 | | | | | |
| | | 3 | 0 | X | X | BST-001 | | | | | |
| | | 4 | 0 | 0 | X | BST-010 | | | | | |
| | 308 | 1 | X | 0 | X | BST-010 | Knob/Lever Key Illuminated Knob | ASD300-2 ASD3K00-2 ASLD300-2 | ASD3100-2 ASD31K00-2 ASLD3100-2 | ASD3200-2 ASD32K00-2 ASLD3200-2 | ASD3300-2 ASD33K00-2 ASLD3300-2 |
| | | 2 | X | X | 0 | BST-001 | | | | | |
| | | 3 | X | 0 | X | BST-010 | | | | | |
| | | 4 | X | X | 0 | BST-001 | | | | | |
| 309 | 1 | X | 0 | X | BST-010 | Knob/Lever Key Illuminated Knob | ASD300-2 ASD3K00-2 ASLD300-2 | ASD3100-2 ASD31K00-2 ASLD3100-2 | ASD3200-2 ASD32K00-2 ASLD3200-2 | ASD3300-2 ASD33K00-2 ASLD3300-2 | |
| | 2 | X | X | 0 | BST-001 | | | | | | |
| | 3 | 0 | X | 0 | BST-001 | | | | | | |
| | 4 | 0 | 0 | X | BST-010 | | | | | | |
| 310 | 1 | 0 | X | 0 | BST-001 | Knob/Lever Key Illuminated Knob | ASD300-2 ASD3K00-2 ASLD300-2 | ASD3100-2 ASD31K00-2 ASLD3100-2 | ASD3200-2 ASD32K00-2 ASLD3200-2 | ASD3300-2 ASD33K00-2 ASLD3300-2 | |
| | 2 | 0 | 0 | X | BST-010 | | | | | | |
| | 3 | 0 | X | 0 | BST-001 | | | | | | |
| | 4 | 0 | 0 | X | BST-010 | | | | | | |

1. Each operator sub-assembly is available as a "-1" and a "-2" for 3-position selector switches. The internal cam of a "-1" is different from that of a "-2". This results in designated combinations of open and closed contacts in the various operator positions.
 2. N/D = No circuit number designation required in assembled part number.
 3. X = On (closed contacts) 0 = Off (open contacts). X-X Overlapping contacts remain on (closed) when switch is moved between these two positions.

Contact Arrangement Chart: 3-Position Selector Switches

| Style | | Mounting Position | Operator Position | | | Contact Block Part Number | Description | Operator Part Number | | | |
|---------|----------------|-------------------|-------------------|---|---|---------------------------|---------------------------------|------------------------------------|---------------------------------------|---------------------------------------|---------------------------------------|
| Contact | Circuit Number | | L | C | R | | | Maintained | Spring Return from Right | Spring Return from Left | Two-Way |
| | | | | | | | | | | | |
| 4NO | N/D | 1 | X | O | O | BST-010 | Knob/Lever Key Illuminated Knob | ASD300-1 ASD3K00-1 ASLD300-1 | ASD3100-1 ASD31K00-1 ASLD3100-1 | ASD3200-1 ASD32K00-1 ASLD3200-1 | ASD3300-1 ASD33K00-1 ASLD3300-1 |
| | | 2 | O | O | X | BST-010 | | | | | |
| | | 3 | X | O | O | BST-010 | | | | | |
| | | 4 | O | O | X | BST-010 | | | | | |
| | 305 | 1 | X | O | X | BST-010 | Knob/Lever Key Illuminated Knob | ASD300-2 ASD3K00-2 ASLD300-2 | ASD3100-2 ASD31K00-2 ASLD3100-2 | ASD3200-2 ASD32K00-2 ASLD3200-2 | ASD3300-2 ASD33K00-2 ASLD3300-2 |
| | | 2 | O | O | X | BST-010 | | | | | |
| | | 3 | X | O | X | BST-010 | | | | | |
| | | 4 | O | O | X | BST-010 | | | | | |
| 4NC | N/D | 1 | O | X | X | BST-001 | Knob/Lever Key Illuminated Knob | ASD300-1 ASD3K00-1 ASLD300-1 | ASD3100-1 ASD31K00-1 ASLD3100-1 | ASD3200-1 ASD32K00-1 ASLD3200-1 | ASD3300-1 ASD33K00-1 ASLD3300-1 |
| | | 2 | X | X | O | BST-001 | | | | | |
| | | 3 | O | X | X | BST-001 | | | | | |
| | | 4 | X | X | O | BST-001 | | | | | |
| | 314 | 1 | O | X | O | BST-001 | Knob/Lever Key Illuminated Knob | ASD300-2 ASD3K00-2 ASLD300-2 | ASD3100-2 ASD31K00-2 ASLD3100-2 | ASD3200-2 ASD32K00-2 ASLD3200-2 | ASD3300-2 ASD33K00-2 ASLD3300-2 |
| | | 2 | X | X | O | BST-001 | | | | | |
| | | 3 | O | X | O | BST-001 | | | | | |
| | | 4 | X | X | O | BST-001 | | | | | |

- Each operator sub-assembly is available as a "-1" and a "-2" for 3-position selector switches. The internal cam of a "-1" is different from that of a "-2". This results in designated combinations of open and closed contacts in the various operator positions.
- N/D = No circuit number designation required in assembled part number.
- X = On (closed contacts) O = Off (open contacts). X-X Overlapping contacts remain on (closed) when switch is moved between these two positions.

Operator Truth Tables

Use the following tables to build custom selector switches.

2 Position Selector Switches

| | Contact | Mounting Position | Operator Position | |
|------------------|------------------|-------------------|-------------------|-------|
| | | | Left | Right |
| ASD200 | BST-010 (NO) | L | O | X |
| | | R | O | X |
| | BST-001 (NC) | L | X | O |
| | | R | X | O |
| | BST-010S (NO-EM) | L | O | X |
| | | R | O | X |
| BST-001S (NC-LB) | L | X | O | |
| | R | X | O | |

3 Position Selector Switches

| | Contact | Mounting Position | Operator Position | | |
|------------------------------------|------------------|-------------------|-------------------|--------|-------|
| | | | Left | Center | Right |
| ASD300-1 ASLD300-1 ASD3K00-1 | BST-010 (NO) | L | X | O | O |
| | | R | O | O | X |
| | BST-001 (NC) | L | O | X | X |
| | | R | X | X | O |
| | BST-010S (NO-EM) | L | X | O | O |
| | | R | O | O | X |
| BST-001S (NC-LB) | L | O | X | X | |
| | R | X | X | O | |

3 Position Push/Pull Switches

| | Contact | Operator Position | | |
|--------|------------------|-------------------|--------|------|
| | | Pull | Normal | Push |
| AYLD22 | BST-010 (NO) | O | O | X |
| | BST-001 (NC) | X | O | O |
| | BST-010S (NO-EM) | O | X | X |
| | BST-001S (NC-LB) | X | X | O |

| | Contact | Mounting Position | Operator Position | | |
|------------------------------------|------------------|-------------------|-------------------|--------|-------|
| | | | Left | Center | Right |
| ASD300-2 ASLD300-2 ASD3K00-2 | BST-010 (NO) | L | X | O | X |
| | | R | O | O | X |
| | BST-001 (NC) | L | O | X | O |
| | | R | X | X | O |
| | BST-010S (NO-EM) | L | X | O | X |
| | | R | O | O | X |
| BST-001S (NC-LB) | L | O | X | O | |
| | R | X | X | O | |

Accessories – TWTD Series

TWTD Series Accessories

| Item | Appearance | Description/Usage | Part Number |
|----------------------|-------------------------------------------------------------------------------------|------------------------------------------------------------------------------------------------------------------------------------|-------------|
| Lamp Removal Tool |  | Rubber tool used to install or remove LED's and incandescent lamps | OR-55 |
| Metal Bezel |  | Standard octagonal units (chrome-pl.). | OG-81 |
| | | Extended, non-illuminated (chrome-pl.). | OG-82 |
| | | Extended, illuminated (chrome-pl.). | OG-83L |
| | | Jumbo Mushroom Shallow Shroud | ABN4G |
| | | Jumbo Mushroom Deep Shroud | ABN4F |
| Plastic Bezel |  | Black plastic locking ring/bezel | OGP11B |
| Boot/Cover |  | In place of ☉, specify Neoprene Rubber Boot color: B (black), G (green), R (red), Y (yellow) | OC-11 ☉ |
| | | Flush units (clear plastic -40° to +60°C). | OC-121 |
| | | Extended units (clear plastic -40° to +60°C). | OC-122 |
| Anti-Rotation Ring |  | Plastic washer For nameplates or panels that should not be scratched. | OGL-D1T |
| | | Thrust washer/Anti-rotation ring for use with notched panel cutout. | OGL-D1S |
| Mounting Hole Plug |  | Plastic with locking nut attached. | OBP-11 |
| | | Metal with locking nut attached | OB-11 |
| | | Grey rubber (-5° to +60°C) | OB-13 |
| Terminal Tab Adaptor |  | Tab #250 17/64" x 3/64" (6.35mm x 0.8mm): Single tab | TW-FA1 |
| Full Voltage Adaptor |  | Used on all full voltage illuminated units. Two required per unit. (M3.5 screw and saddle) | APD-F |
| Lock Out Adaptor |  | Used to provide lockout protection for TWTD pushbuttons and knob selectors. ø 1-13/64" (30mm) | OL-KL1 |
| Replacement Keys |  | Pair of keys (#0) | TW-SK |

Fingersafe Covers for TWTD Series

| Item | Description | Used with | Part Number |
|------------------------------------------------------------------------------------|-------------------------------------------------------------------------------------|------------------------------------------------|-------------|
|  | Fingersafe terminal cover, for full voltage pilot lights, adds 3mm to overall depth | APD199... full voltage pilot lights | APD-PVL |
|  | Fingersafe terminal cover, for contact blocks, adds 3mm to overall depth | Non-Illuminated pushbuttons ABD..., and AOD... | N-VL2 |
|  | Fingersafe terminal cover, adds 1.5mm to overall depth | Transformer pilot lights and illuminated units | N-VL3 |
|  | Fingersafe terminal cover, adds 4 mm to depth | Full voltage illuminated pushbuttons | N-VL4 |

Switches & Pilot Devices

Signaling Lights

Relays & Sockets

Timers

Contactors

Terminal Blocks

Circuit Breakers

Nameplates – TWTD Series

Faceplates

| | NALD | NAKD | NAQD | HNAV |
|----------------------|--------------------------------|--------------------------------|--------------------------------|--------------------------|
| Dimensions | | | | |
| Description | Part Number | | | |
| Nameplate (blank) | NALD-B (black) NALD-R (red) | NAKD-B (black) NAKD-R (red) | NAQD-B (black) NAQD-R (red) | HNAV-0 |
| Nameplate (engraved) | NALD-⓪ | NAKD-⓪ | NAQD-⓪ | HNAV-27 "Emergency Stop" |

1. Nameplates are made of 0.031" aluminum. Lettering is white letters engraved on black background.
2. In place of ⓪, insert either the standard legend code from table below or custom engraving delimited by " ".
3. HNAV available in yellow only.

Standard Legend Codes

| Pushbuttons | | | | Pushbuttons/Selector Switches | | | | Selector Switches | |
|-------------|------|---------------|------|-------------------------------|------|------------|------|-------------------|------|
| Legend | Code | Legend | Code | Legend | Code | Legend | Code | Legend | Code |
| AUTO | 101 | OPEN | 116 | AUTO-MAN | 201 | | | AUTO-MAN-OFF | 301 |
| CLOSE | 102 | OUT | 117 | CLOSE-OPEN | 202 | | | AUTO-OFF-MAN | 302 |
| DOWN | 103 | RAISE | 118 | DOWN-UP | 203 | | | CLOSE-OFF-OPEN | 303 |
| EMERG.STOP* | 104 | RESET | 119 | FAST-SLOW | 204 | | | DOWN-OFF-SLOW | 304 |
| FAST | 105 | REVERSE | 120 | FOR-REV | 205 | REV-FOR | 216 | FAST-OFF-SLOW | 305 |
| FORWARD | 106 | RUN | 121 | HAND-AUTO | 206 | RUN-JOG | 217 | FOR-OFF-REV | 306 |
| HAND | 107 | SLOW | 122 | HIGH-LOW | 207 | RUN-SAFE | 218 | LEFT-OFF-RIGHT | 307 |
| HIGH | 108 | START | 123 | JOG-RUN | 208 | SAFE-RUN | 219 | LOWER-OFF-RAISE | 308 |
| IN | 109 | STOP* | 124 | LEFT-RIGHT | 209 | SLOW-FAST | 220 | OFF-MAN-AUTO | 309 |
| INCH | 110 | STOP | 125 | LOWER-RAISE | 210 | START-STOP | 221 | OFF-SLOW-FAST | 310 |
| JOG | 111 | TEST | 126 | MAN-AUTO | 211 | STOP-START | 222 | OFF-1-2 | 311 |
| LOW | 112 | UP | 127 | OFF-ON | 212 | UP-DOWN | 223 | OPEN-OFF-CLOSE | 312 |
| LOWER | 113 | I (Int'l On) | 150 | ON-OFF | 213 | | | SLOW-OFF-FAST | 313 |
| OFF | 114 | O (Int'l Off) | 151 | OPEN-CLOSE | 214 | | | SUMMER-OFF-WINTER | 314 |
| ON | 115 | EMO | 152 | RAISE-LOWER | 215 | | | UP-OFF-DOWN | 315 |
| | | | | | | | | 1-OFF-2 | 316 |
| | | | | | | | | HAND-OFF-AUTO | 317 |

1. *Available in Red as standard legend code 104 and 124. To order engraved nameplate and codes, add legend code to nameplate part number. Character height based on the number of characters, space and size of nameplate. Standard character size is 3/16".
2. Nameplates with standard legends are the same list price as blank nameplates. Special engravings, additional cost.

To specify engraving instructions, use the Nameplate order form on next page.

Custom engraved Nameplates Order Form – TWTD Series

Copy this order form and use it to specify Letter Height, Custom Engravings, Location of Engraving on Nameplate, and Quantity Desired.

To ensure engraving accuracy, fax it to your IDEC representative, or Distributor.

Your Company Name: _____

IDEC Rep/Distributor Contact: _____

Your Name: _____

PO number (if known): _____

Telephone: _____

IDEC Rep/Distributor Phone: _____

Fax & Email: _____

IDEC Rep/Distributor Fax & Email: _____

NALD Nameplate

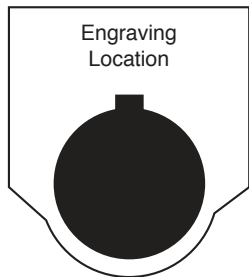

Step 1.

Choose Letter Size - 7/64" or 1/8".

Check the box for the letter size you want. Then write your lettering in box below checkboxes. Note: 1/8" size letters cannot exceed 13 characters.

Sample Letter Sizes

7/64"
Letter Size 16 characters max
(for 7/64" size letters)

7/64" Letters: A B C D

1/8" Letters: A B C D

1/8"
Letter Size 13 characters max
(for 1/8" size letters)

Step 2.

Specify Quantity.

Enter the number of nameplates desired in the box on the right.

Qty

| | | | | | | | | | | | | | | | |
|---|---|---|---|---|---|---|---|---|----|----|----|----|----|----|----|
| 1 | 2 | 3 | 4 | 5 | 6 | 7 | 8 | 9 | 10 | 11 | 12 | 13 | 14 | 15 | 16 |
|---|---|---|---|---|---|---|---|---|----|----|----|----|----|----|----|

NAKD Nameplate

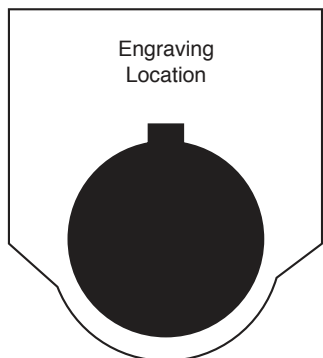

Step 1.

Choose Letter Size - 7/64" or 1/8".

Check the box for the letter size you want. Then write your lettering in box below checkboxes. Note: 1/8" size letters cannot exceed 9 characters.

Step 2.

Specify Quantity.

Enter the number of nameplates desired in the box on the right.

Qty

| | | | | | | | | | | | | | | | | |
|---|---|---|---|---|---|---|---|---|----|----|----|----|----|----|----|----|
| 1 | 2 | 3 | 4 | 5 | 6 | 7 | 8 | 9 | 10 | 11 | 12 | 13 | 14 | 15 | 16 | 17 |
|---|---|---|---|---|---|---|---|---|----|----|----|----|----|----|----|----|

Sample Letter Sizes

1/8" Letters: A B C D

NAQD Nameplate

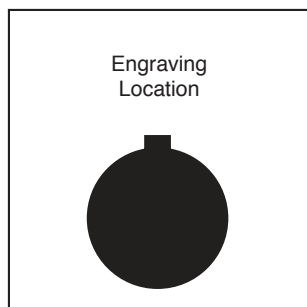

Step 1.

Choose Letter Size - 7/64" or 1/8".

Check the box for the letter size you want. Then write your lettering in box below checkboxes.

Note: 1/8" size letters cannot exceed 16 characters.

7/64"
Letter Size 20 characters max
(for 7/64" size letters)

1/8"
Letter Size 16 characters max
(for 1/8" size letters)

Step 2.

Specify Quantity.

Enter the number of nameplates desired in the box on the right.

Qty

| | | | | | | | | | | | | | | | | | | | |
|---|---|---|---|---|---|---|---|---|----|----|----|----|----|----|----|----|----|----|----|
| 1 | 2 | 3 | 4 | 5 | 6 | 7 | 8 | 9 | 10 | 11 | 12 | 13 | 14 | 15 | 16 | 17 | 18 | 19 | 20 |
|---|---|---|---|---|---|---|---|---|----|----|----|----|----|----|----|----|----|----|----|

Sample Letter Sizes

3/32" Letters: A B C D

1/8" Letters: A B C D

Switch Engraving Order Form – TWTD Series

Copy this order form and use it to specify Letter Height, Maximum Number of Lines and Text to be engraved.

To insure engraving accuracy, fax it to your IDEC representative or Distributor.

Your Company: _____
 Name: _____
 Address: _____
 PO: _____

Telephone: _____
 Fax: _____
 Email: _____
 Part Number to be Engraved: _____

Please check one of the boxes below to indicate your choice of engraving options:



ø29mm, ø40mm Mushroom Head

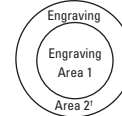

| | # of Lines | Letter Height | Max. Characters Per Line |
|--------------------------|------------|---------------|--------------------------|
| <input type="checkbox"/> | 1 | 5/32 | 7 |
| <input type="checkbox"/> | | 1/8 | 8 |
| <input type="checkbox"/> | 2 | 5/32 | 7 |
| <input type="checkbox"/> | | 1/8 | 8 |
| <input type="checkbox"/> | 3 | 1/8 | 8 |
| <input type="checkbox"/> | 4 | Custom* | |

| | # of Lines | Letter Height | Max. Characters Per Line |
|--------------------------|------------|---------------|--------------------------|
| <input type="checkbox"/> | 1 | 3/4 | 4 |
| <input type="checkbox"/> | | 5/16 | 5 |
| <input type="checkbox"/> | 2 | 5/16 | 5 |
| <input type="checkbox"/> | | 1/4 | 6 |
| <input type="checkbox"/> | | 5/32 | 8 |
| <input type="checkbox"/> | 3 | 5/32 | 8 |
| <input type="checkbox"/> | | 1/8 | 9 |
| <input type="checkbox"/> | 4 | 1/8 | 9 |

| | # of Lines | Letter Height | Max. Characters Per Line |
|--------------------------|------------------|---------------|--------------------------|
| <input type="checkbox"/> | Engraving Area 1 | 5/32 | 5 |
| <input type="checkbox"/> | | 1/8 | 5 |
| <input type="checkbox"/> | Engraving Area 2 | 5/32 | 7 |
| <input type="checkbox"/> | | 1/8 | 7 |



- Above mentioned specifications hold true for standard size push-buttons (round and square).
- *Engraving Area 2 can be engraved for 40mm mushroom head non-illuminated pushbutton only.
- Engraving is done on the button itself for non-illuminated push buttons and on marking plate for illuminated push buttons and pilot lights.
- Please enter text exactly how you want it engraved, take care to emphasize capital or small letters.

*Engraving is possible, but character size will be smaller than standard sizes.



| | # of Lines | Letter Height | Max. Characters Per Line |
|--------------------------|------------|---------------|--------------------------|
| <input type="checkbox"/> | 1 | 5/32 | 7 |
| <input type="checkbox"/> | | 1/8 | 8 |
| <input type="checkbox"/> | 2 | 5/32 | 7 |
| <input type="checkbox"/> | | 1/8 | 8 |
| <input type="checkbox"/> | 3 | 1/8 | 8 |
| <input type="checkbox"/> | 4 | Custom* | |

*Engraving is possible, but character size will be smaller than standard sizes.

Enter text to be engraved:

Line 1: _____
 Line 2: _____
 Line 3: _____
 Line 4: _____

Sample Letter Sizes

1/8 Letters: **OPEN**

5/32 Letters: **OPEN**



All engraving is 5/8mm wide.

For IDEC Internal Use Only:

Work Order #: _____

Dimensions (mm)

Pushbutton

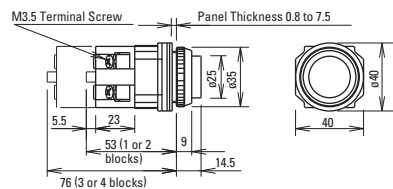

Mushroom Pushbutton w/Full Shroud

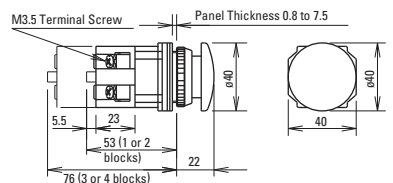

| Pushbuttons | Dimension A | Dimension B |
|---------------------------------------------|-----------------------------------|----------------------------------|
| Flush | 0.351" (9mm) | ø 0.975" (25mm) |
| Extended | 0.566" (14.5mm) | ø 0.975" (25mm) |
| Extended w/Full Shroud | 0.663" (17mm) | ø 1.11" (28.5mm) |
| Mushroom | 0.858" (22mm) | ø 1.56" (40mm) |
| Mushroom w/Full Shroud | 0.936" (24mm) | ø 1.87" (48mm) |
| Jumbo Mushroom | 1.13" (29mm) | ø 2.54" (65mm) |
| Mushroom, Pushlock Turn Reset and Push-Pull | *0.975" (25mm) **0.975" (25mm) | ø 1.56" (40mm) ø 1.56" (40mm) |



*Dimension when operator is in reset position.
**Dimension when operator is in pull position.

Illuminated Pushbuttons

w/Transformer

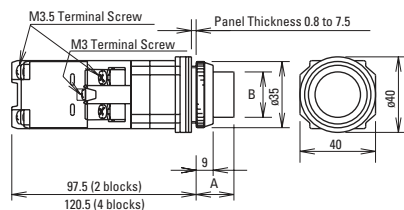

Full Voltage

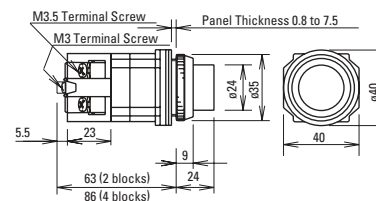

| Illuminated Pushbuttons | Dimension A | Dimension B |
|--------------------------------------------------------|-----------------------------------|------------------------------------|
| Flush w/Full Shroud | 0.975" (25mm) 0.995" (25.5mm) | ø 0.936" (24mm) ø 0.936" (24mm) |
| Extended w/Full Shroud | 0.741" (19mm) 0.761" (19.5mm) | ø 0.936" (24mm) ø 0.936" (24mm) |
| ø 1.56" (40mm) Mushroom Pushlock Turn Reset, Push-Pull | *0.975" (25mm) **0.975" (25mm) | ø 1.56" (40mm) ø 1.56" (40mm) |

*Dimension when operator is in reset position.
**Dimension when operator is in pull position.

Pilot Lights

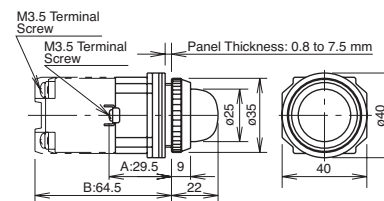

Selector Switches

Knob

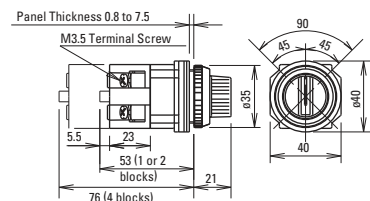

Lever

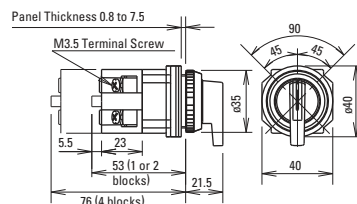

Key

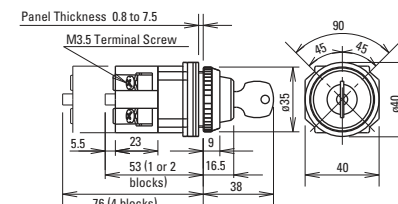

Illuminated Knob

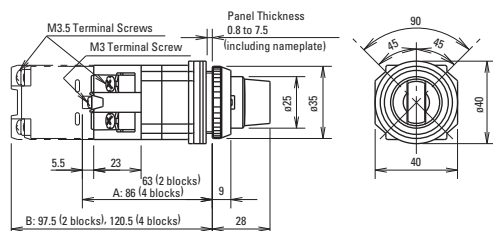

Selector Switches Panel Cut-Out

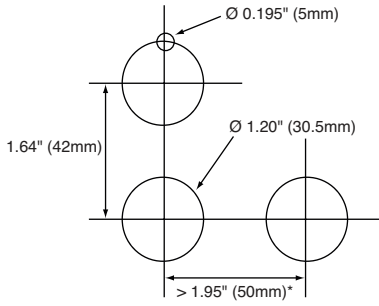

- * Jumbo Mushroom < 2.61" (66mm)
- Minimum mounting centers are applicable to switches with one stack of contact blocks. When mounting two stacks of contact blocks, minimum centers should allow for access to wiring.
- The ø 0.195" (ø 5mm) recess is necessary when either the nameplate or anti-rotation ring is used.

Illuminated Selector Switches

OL-KL1
Lock-Out Adaptor

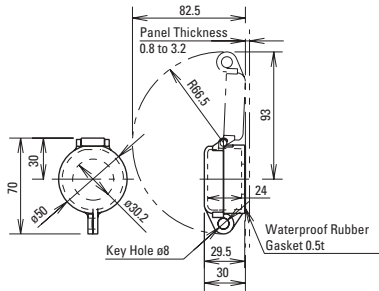

OC-31
Pushbutton Clear Boot

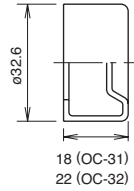

OGL-31
Anti-Rotation Ring

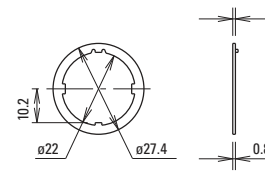

OB-31
Mounting Hole Rubber Plug

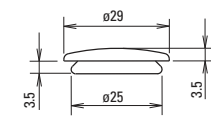

Finger-Safe Cover

N-VL2

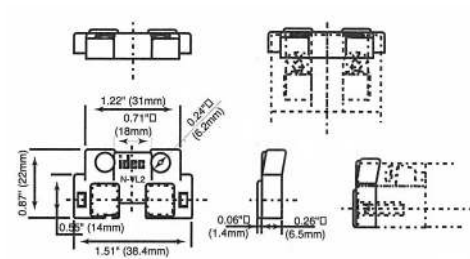

N-VL3

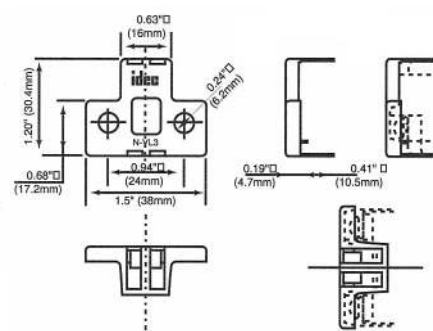

N-VL4

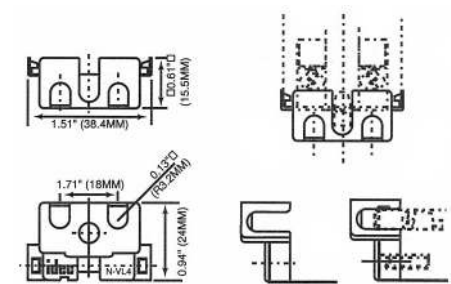

APD-PVL

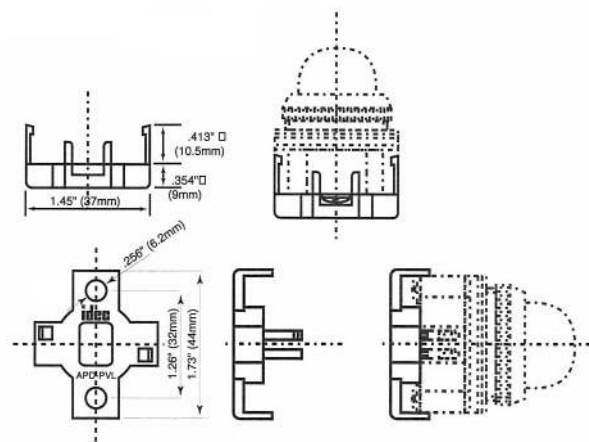

Operating Instructions

Adjustment for Panel Thickness

Each unit is shipped with several waterproof gaskets which are 0.06" (1.5mm) and 0.12" (3mm) thick. Combine the gaskets for a dimension approximately equal to panel thickness and install between the bezel and the body of the unit.

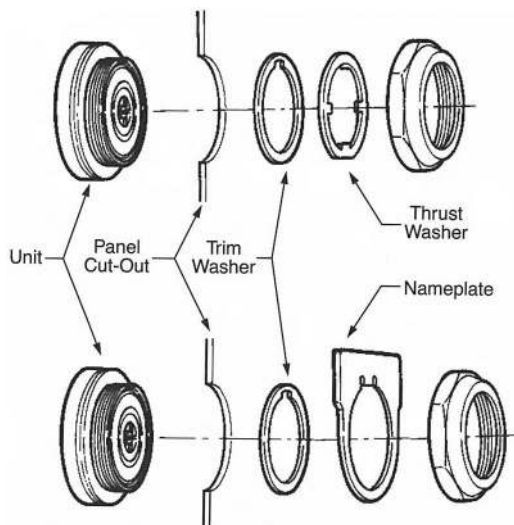

A trim washer must be used with a thrust washer or a nameplate to prevent the control unit from rotating in the mounting hole. When using anti-rotation rings (trim washer with thrust washer or nameplate), install as shown below.

Selector Switches

The operator shaft of each unit has a recess to identify in which direction to install the handle. Align the handle with the recess. Press color insert (TW-HC1) into the Standard Operating Positions.

Standard Operation Positions

| 2-Position, 90° | 3-Position, 45° |
|-----------------|-----------------|
| | |

Non-Illuminated 3-Position Operators

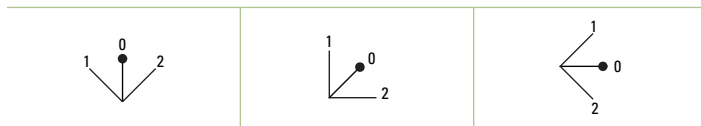

Installation of TWTD Series Units

TWTD Pilot Lights

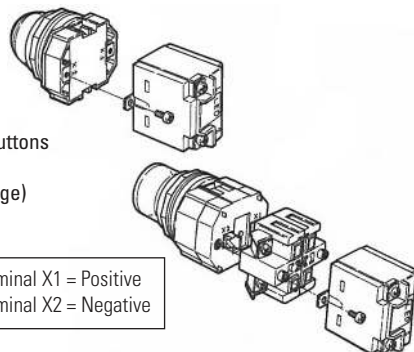

TWTD Illuminated Pushbuttons
TWTD Selector Switches
(Transformer or Full Voltage)

Terminal X1 = Positive
Terminal X2 = Negative

Installation of LED Illuminated Units

Transformer units are recommended for use in areas subjected to inductive noise. When using full voltage types, install a protection diode as shown below. Use diode with DC power supply to protect against surges and noise.



Make sure that LED illuminated units are installed with correct polarity, as indicated at the terminals.

Application Example For Push-To-Test Pilot Light

A typical application of illuminated pushbuttons is a push-to-test pilot light which can be used to check the lamp/LED circuit.

Transformer/AC-Adapter Circuit

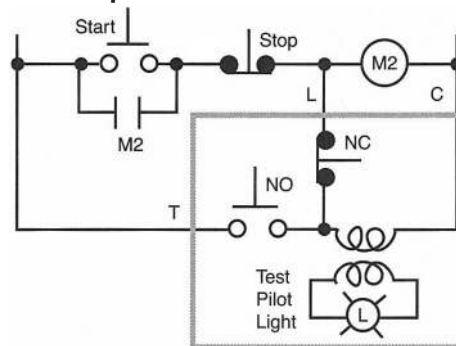

Full Voltage Circuit

