

General information

Part number	S11MAC-P07MFG0-6560
Termination	solder
Size	1
Locking principle	push
Coding	a key_medi
Cable Diameter	cable_medi_65
Cable outlet	standard

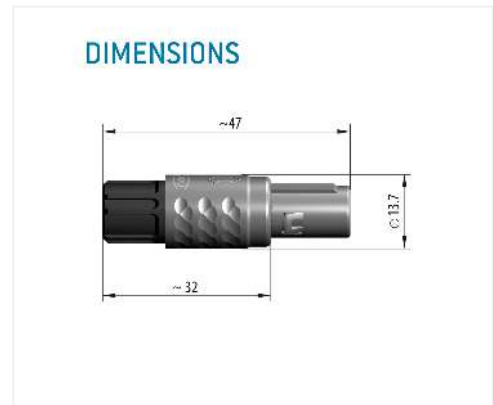

Contact insert description

Number of contacts	7
Contact type	pins
Contact diameter	07mm
Insulator material	peek
Wire cross section	22_awg
Termination	solder
Termination diameter	085mm

reverse_gender_on_request

Technical information

Max. creepage and air clearance distance	065 mm	
Nominal current single contact	075_a	iec_60512_5_2
Nominal current insert	4,875 A	vde_0298_4
Test voltage	135_kv_dc	sae_13441

safety_text

Mechanical and environmental data

Degree of protection*	ip50
Operating temperature	50_120_c
Mating cycles	2000

mated_unmated

Material and surface treatments

Housing	m_chrome
Color option	blue
Contact	cu_alloy_gold

safety_text_2
ul_text
illustrative_text