

BTF Series

Ultra-slim and amplifier built-in type

■ Features

- Realization of ultra-slim size by adopting one-chip photo IC
- Size: Through-beam(W13×H19×L3.7mm),
Diffuse reflective, BGS reflective(W13×H24×L3.7mm)
- Adopts BGS method superior than convergent reflective to minimize error by background color, or material of sensing object for stable sensing
- Visible light source to check the position of sensing spot and superior to small sensing target with narrow sensing width
- Built-in reverse polarity, output short, overcurrent protection circuit
- Protection structure IP67(IEC standard)

 Please read "Caution for your safety" in operation manual before using.



■ Specifications

| Model | NPN open collector output | | BTF1M-TDTL | | BTF1M-TDTD | | BTF30-DDTL | | BTF30-DDTD | | BTF15-BDTL | | BTF15-BDTD | |
|---|--|--|---|--|---|--|--------------|--|---|--|--------------|--|--------------|--|
| | PNP open collector output | | BTF1M-TDTL-P | | BTF1M-TDTD-P | | BTF30-DDTL-P | | BTF30-DDTD-P | | BTF15-BDTL-P | | BTF15-BDTD-P | |
| Sensing type | Through-beam | | | | Diffuse reflective | | | | BGS reflective | | | | | |
| Sensing distance | 1m | | | | 5 to 30mm (Non-glossy white paper 50×50mm) | | | | 1 to 15mm (Non-glossy white paper 50×50mm) | | | | | |
| Sensing target | Opaque materials of max. ϕ 2mm | | | | Opaque materials, Translucent materials | | | | | | | | | |
| Min.sensing target | Opaque materials of ϕ 2mm | | | | ϕ 0.2mm (Sensing distance 10mm) | | | | ϕ 0.2mm non-illuminated objects (Sensing distance 10mm) | | | | | |
| Hysteresis | — | | | | Max. 20% at rated sensing distance | | | | Max. 5% at rated sensing distance | | | | | |
| Reflectivity characteristics (black/white error) | — | | | | — | | | | Max. 15% of maximum sensing distance | | | | | |
| Response time | Max. 1ms | | | | | | | | | | | | | |
| Power supply | 12-24VDC \pm 10%(Ripple P-P: Max. 10%) | | | | | | | | | | | | | |
| Current consumption | Max. 20mA(This is for each emitter and receiver of through-beam type) | | | | | | | | | | | | | |
| Light source | Red LED(650nm) | | | | | | | | | | | | | |
| Operation mode | Light ON | | Dark ON | | Light ON | | Dark ON | | Light ON | | Dark ON | | | |
| Control output | NPN or PNP open collector output ●Load voltage: Max. 26.4VDC ●Load current: Max. 50mA ●Residual voltage - NPN:Max. 1V, PNP:Max. 2V | | | | | | | | | | | | | |
| Protection circuit | Reverse polarity protection, output short-circuit protection | | | | | | | | | | | | | |
| Indicator | Operation indicator: Red, Stability indicator: Green | | | | | | | | | | | | | |
| Insulation resistance | Min. 20M Ω (at 500VDC megger) | | | | | | | | | | | | | |
| Noise resistance | \pm 240V the square wave noise(pulse width:1 μ s) by the noise simulator | | | | | | | | | | | | | |
| Dielectric strength | 1,000VAC 50/60Hz for 1 minute | | | | | | | | | | | | | |
| Vibration | 1.5mm amplitude or 300m/s ² at frequency of 10 to 55Hz(for 1 min.) in each of X, Y, Z directions for 2 hours | | | | | | | | | | | | | |
| Shock | 500m/s ² (approx. 50G) in each of X, Y, Z directions for 3 times | | | | | | | | | | | | | |
| Environment | Ambient illumination | | Sunlight: Max. 10,000lx Incandescent lamp: Max. 3,000lx (Receiver illumination) | | | | | | | | | | | |
| | Ambient temperature | | -25 to 55°C, storage: -40 to 70°C | | | | | | | | | | | |
| | Ambient humidity | | 35 to 85%RH, storage: 35 to 85%RH | | | | | | | | | | | |
| Protection | IP67(IEC standards) | | | | | | | | | | | | | |
| Material | Case: PBT, Sensing part : PMMA | | | | | | | | | | | | | |
| Cable | ϕ 2.5, 3-wire, Length: 2m (Emitter of through-beam type: ϕ 2.5, 2-wire, Length: 2m) (AWG28, Core diameter: 0.08mm, Number of cores: 19, Insulator out diameter: ϕ 0.9) | | | | | | | | | | | | | |
| Accessory | Fixing bracket(SUS304), Bolt(SWCH10A) | | | | | | | | | | | | | |
| Approval |  | | | | | | | | | | | | | |
| Unit weight | Approx. 40g | | | | Approx. 25g | | | | | | | | | |

※The temperature or humidity mentioned in Environment indicates a non freezing or condensation environment.

Ultra-Slim and Amplifier Built-in type

■ Feature data

◎ Through-beam

● BTF1M-TDTL / BTF1M-TDTL-P

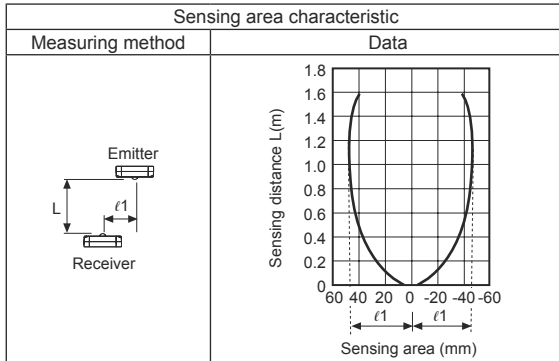

◎ Diffuse reflective

● BTF30-DDTL / BTF30-DDTL-P

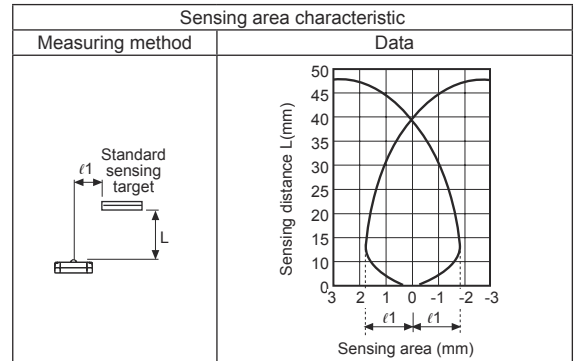

◎ BGS reflective

● BTF15-BDTL / BTF15-BDTL-P

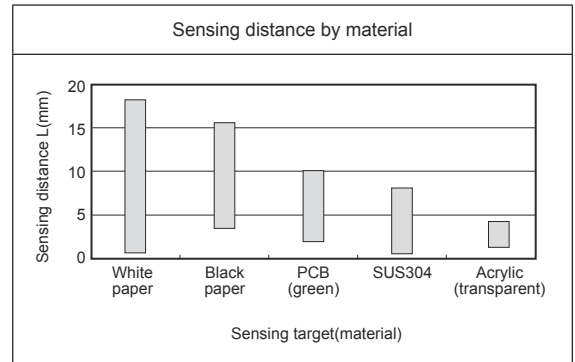
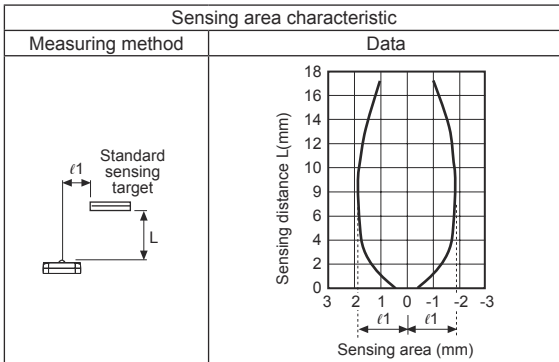

■ Connections

● Through-beam

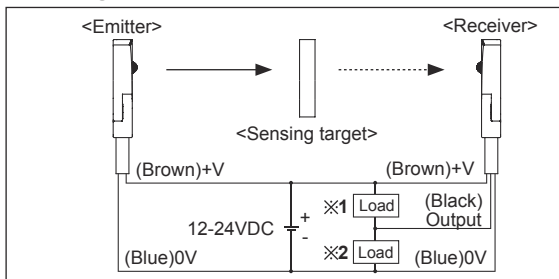

● Diffuse reflective/BGS reflective

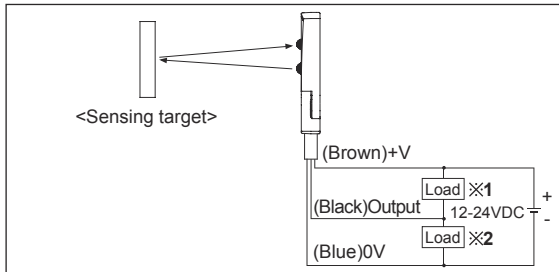

※1: Load connection for NPN output

※2: Load connection for PNP output

■ Control output diagram

● NPN open collector output

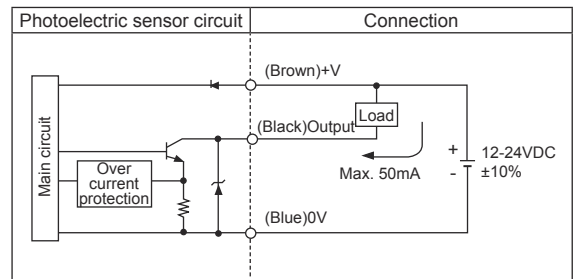

● PNP open collector output

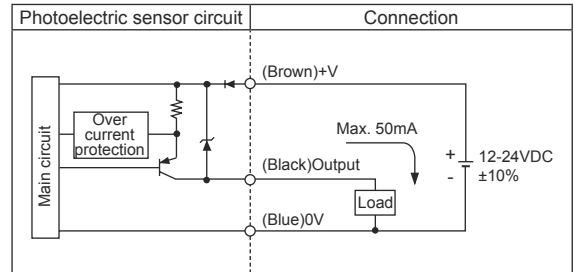

(A) Photo electric sensor

(B) Fiber optic sensor

(C) Door/Area sensor

(D) Proximity sensor

(E) Pressure sensor

(F) Rotary encoder

(G) Connector/Socket

(H) Temp. controller

(I) SSR/ Power controller

(J) Counter

(K) Timer

(L) Panel meter

(M) Tacho/ Speed/ Pulse meter

(N) Display unit

(O) Sensor controller

(P) Switching mode power supply

(Q) Stepper motor & Driver&Controller

(R) Graphic/ Logic panel











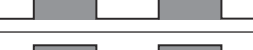

(S) Field network device

(T) Software

(U) Other

BTF Series

■ Operation mode

| Operation mode | Light ON | Dark ON |
|-------------------------------|---|---|
| Receiver operation | Received light  Interrupted light  | Received light  Interrupted light  |
| Operation indicator (red LED) | ON  OFF  | ON  OFF  |
| Transistor output | ON  OFF  | ON  OFF  |

■ Dimensions

(unit: mm)

● Through-beam

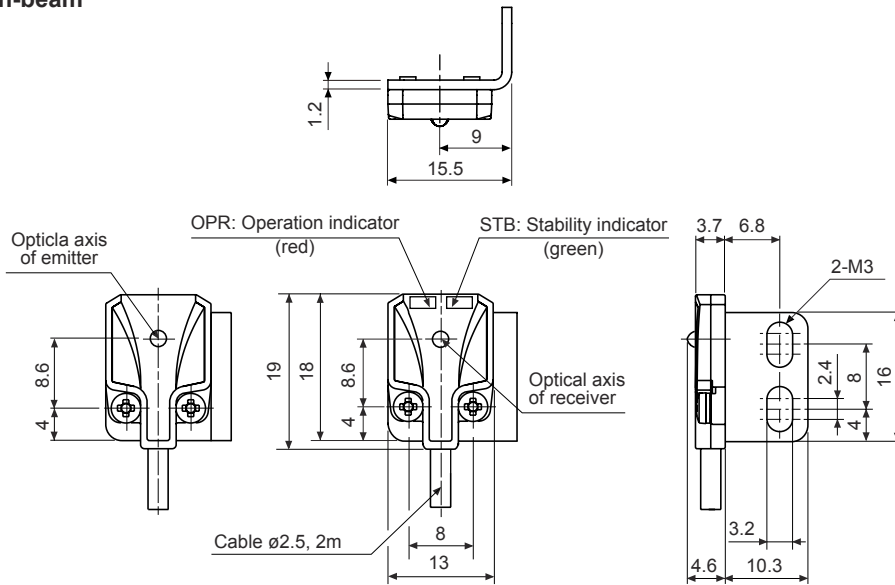

● Diffuse reflective/BGS reflective

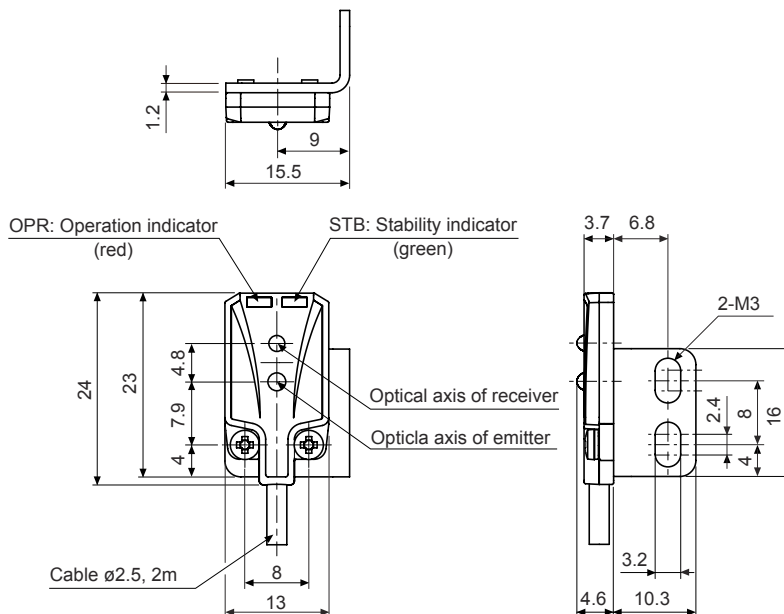

Ultra-Slim and Amplifier Built-in type

■ Operation timing diagram

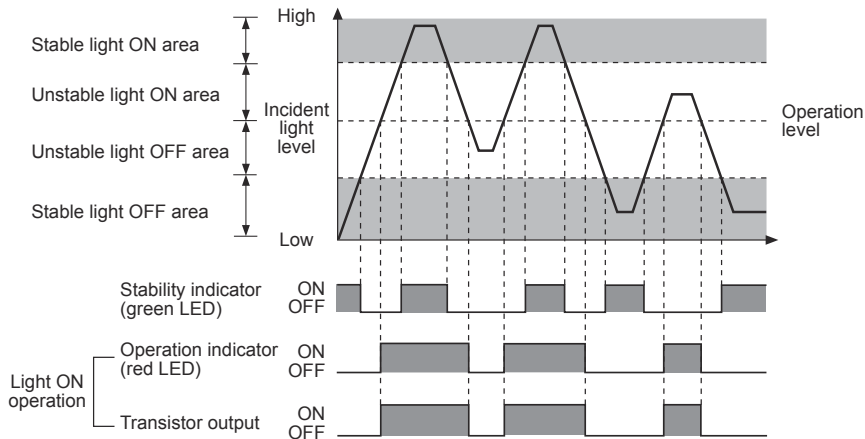

※ The waveforms of "Operation indicator" and "Transistor output" are for Light ON operation. They are opposite operation for Dark ON operation.

■ Mounting and sensitivity adjustment

◎ For mounting

Please use bolts M2 for mounting this sensor and the tightening torque is under 0.3 N·m.

※ Do not impact on the unit with hard objects and do not bend the cable part too much. It may cause damage to waterproof function.

● Through-beam

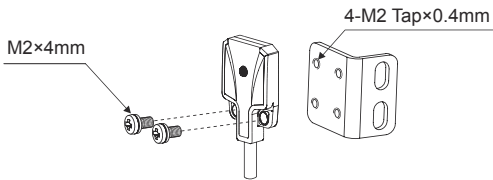

● Diffuse reflective/BGS reflective

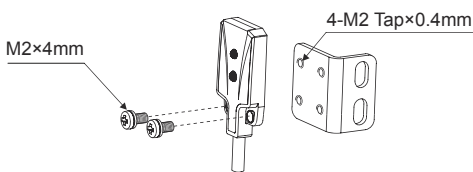

※ Notice for BGS reflective type

1) Make sure that the sensing side of this sensor is parallel with the surface of each sensing object.

2) If the sensing object has glossy surface or high reflection, the sensor tilts to 5 to 10° as shown in the figure. Make sure whether the sensor is influenced by any background objects.

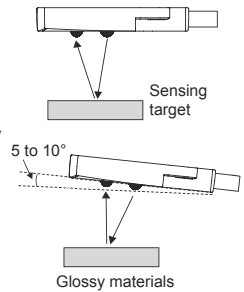

3) Make sure to install the sensor in the proper direction with considering moving direction of sensing objects. Refer to the following.

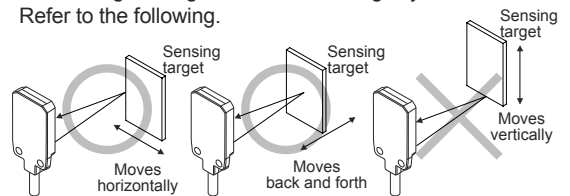

◎ Optical axis adjustment

● Through-beam

Set the emitter and the receiver facing each other and adjust these up-down, right-left after to check the point operating the stability indicator. Fix the emitter and the receiver at the center of the point.

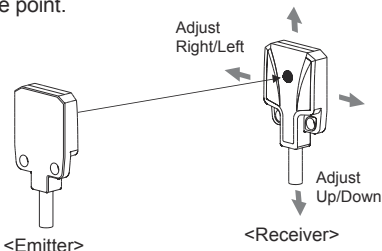

● Diffuse reflective/BGS reflective

After place a sensing target, fix it in the middle of position where the stability indicator operates adjusting the sensor to up-down, right-left. Make sure that the sensing side of the sensor is parallel with the surface of each sensing target.

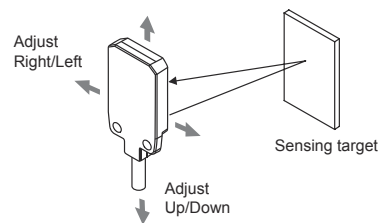

(A) Photo electric sensor

(B) Fiber optic sensor

(C) Door/Area sensor

(D) Proximity sensor

(E) Pressure sensor

(F) Rotary encoder

(G) Connector/Socket

(H) Temp. controller

(I) SSR/Power controller

(J) Counter

(K) Timer

(L) Panel meter

(M) Tacho/Speed/Pulse meter

(N) Display unit

(O) Sensor controller

(P) Switching mode power supply

(Q) Stepper motor& Driver&Controller

(R) Graphic/Logic panel

(S) Field network device

(T) Software

(U) Other