

XMLC070D2S13

Electromechanical pressure sensor, Pressure sensors XM, switch XMLC 70 bar, adjustable scale 2 thresholds, 2 C/O



Main

Range of Product	OsiSense XM
Product or Component Type	Electromechanical pressure sensor
Pressure sensor type	Electromechanical pressure sensor
Device short name	XMLC
Pressure Rating	1015.26 psi (70 bar)
Controlled fluid	Hydraulic oil 32...320 °F (0...160 °C))
Fluid connection type	1/4" - 18 NPTF (female)
Electrical connection	Screw-clamps terminals, 1 x 0.5...2 x 2.5 mm ²
AWG Gauge	AWG 20...AWG 14
Cable entry	Cable gland 0.28...0.51 in (7...13 mm)
Contacts type and composition	2 C/O
Product Specific Application	-
Pressure switch type of operation	Regulation between 2 thresholds
Electrical circuit type	Control circuit
Scale type	Adjustable differential
Local display	With
Adjustable range of switching point on rising pressure	101.53...1015.26 psi (7...70 bar)
Adjustable range of switching point on falling pressure	36.26...886.18 psi (2.5...61.1 bar)
Possible differential maximum at high setting	870.23 psi (60 bar)
Maximum permissible accidental pressure	2320.60 psi (160 bar)
Destruction pressure	4641.21 psi (320 bar)
Pressure actuator	Piston
Materials in contact with fluid	Brass PTFE Steel FPM, FKM
Enclosure Material	Zinc alloy
Line Rated Current	3 A, B300, AC-15 (Ue = 120 V)EN/IEC 60947-5-1 1.5 A, B300, AC-15 (Ue = 240 V)EN/IEC 60947-5-1 0.1 A, R300, DC-13 (Ue = 250 V)EN/IEC 60947-5-1

Complementary

Possible differential minimum at low setting	65.27 psi (4.5 bar) +/- 0.8 bar)
Possible differential minimum at high setting	129.08 psi (8.9 bar) +/- 0.8 bar)
Maximum permissible pressure - per cycle	1305.34 psi (90 bar)
Terminal block type	8 terminals
Maximum operating rate	60 cyc/mn
Repeat accuracy	2 %
[Ui] rated insulation voltage	300 V UL 508 500 V EN/IEC 60947-1 300 V CSA C22.2 No 14

The information provided in this documentation contains general descriptions and/or technical characteristics of the performance of the products contained herein. This documentation is not intended as a substitute for and is not to be used for determining suitability or reliability of these products for specific user applications. It is the duty of any such user or integrator to perform the appropriate and complete risk analysis, evaluation and testing of the products with respect to the relevant specific application or use thereof. Neither Schneider Electric Industries SAS nor any of its affiliates or subsidiaries shall be responsible or liable for misuse of the information contained herein.

[Uimp] rated impulse withstand voltage	6 kV EN/IEC 60947-1
Auxiliary contacts operation	Simultaneous, snap action
Contacts material	Silver contacts
Maximum resistance across terminals	25 MOhm IEC 255-7 category 3 25 mOhm NF C 93-050 method A
Short-circuit protection	10 A cartridge fuse gG (gl)
Mechanical durability	6000000 cycles
Setting	External
Height	4.45 in (113 mm)
Depth	3.35 in (85 mm)
Width	1.81 in (46 mm)
Net Weight	1.53 lb(US) (0.695 kg)

Environment

Standards	UL 508 CSA C22.2 No 14 CE EN/IEC 60947-5-1
Product Certifications	CSA EAC UL
Protective treatment	TC standard version
Ambient Air Temperature for Operation	-13...158 °F (-25...70 °C)
Ambient Air Temperature for Storage	-40...158 °F (-40...70 °C)
Operating position	Any position
Vibration resistance	4 gn 30...500 Hz)IEC 60068-2-6
Shock resistance	50 gn IEC 60068-2-27
Electrical shock protection class	Class I IEC 1140 Class I IEC 536 Class I NF C 20-030
IP degree of protection	IP66 conforming to EN/IEC 60529



Ordering and shipping details



Category	22661-XMLA,B,C,D PRESSURE SWITCHES
Discount Schedule	DS2
GTIN	3389110943948
Nbr. of units in pkg.	1
Package weight(Lbs)	30.69 oz (870.0 g)
Returnability	No
Country of origin	CZ

Packing Units

Unit Type of Package 1	PCE
Package 1 Height	2.36 in (6 cm)
Package 1 width	5.91 in (15 cm)
Package 1 Length	4.21 in (10.7 cm)

Offer Sustainability

Sustainable offer status	Green Premium product
California proposition 65	WARNING: This product can expose you to chemicals including: Diisononyl phthalate (DINP), which is known to the State of California to cause cancer, and Di-isodecyl phthalate (DIDP), which is known to the State of California to cause birth defects or other reproductive harm. For more information go to www.P65Warnings.ca.gov
REACH Regulation	 REACH Declaration
EU RoHS Directive	Pro-active compliance (Product out of EU RoHS legal scope)  EU RoHS Declaration
Mercury free	Yes

RoHS exemption information	 Yes
Environmental Disclosure	 Product Environmental Profile

Contractual warranty

Warranty	18 months
----------	-----------

Dimensions

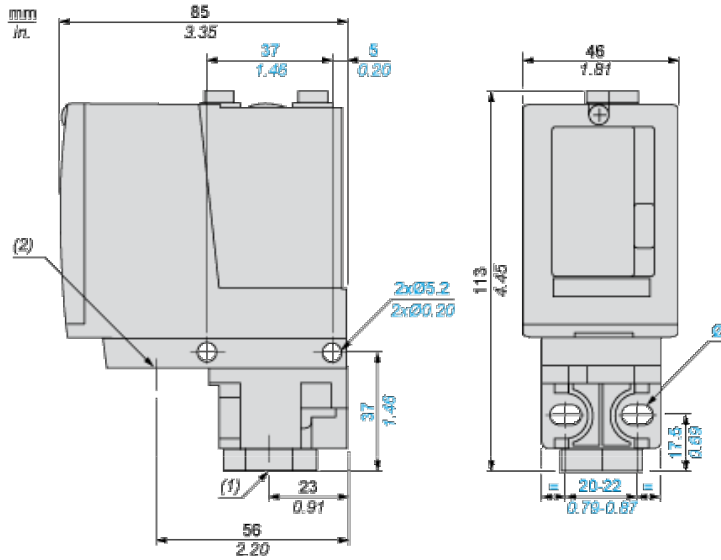

- (1) 1 fluid entry, tapped 1/4" NPTF
(2) 1 electrical connections entry, tapped 1/2" NPT
Ø : 2 elongated holes Ø 5.2 x 6.7

Wiring Diagram

Terminal Model



Operating Curves

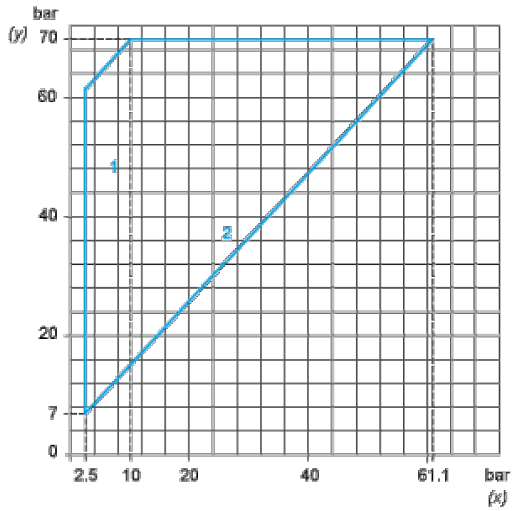

- (y) Rising pressure
- (x) Falling pressure
- 1 : Maximum differential
- 2 : Minimum differential

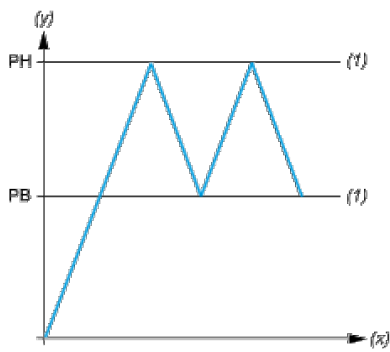

- (y) Pressure
- (x) Time
- (1) Adjustable value
- PH : High point
- PB : Below point