

MSCSM70TAM10CTPAG
Datasheet
Triple Phase Leg SiC MOSFET Power Module

April 2020



a  **MICROCHIP** company

Contents

1 Revision History.....	1
1.1 Revision 1.0.....	1
2 Product Overview.....	2
2.1 Features.....	3
2.2 Benefits.....	3
2.3 Applications.....	3
3 Electrical Specifications.....	4
3.1 SiC MOSFET Characteristics (Per MOSFET).....	4
3.2 SiC Schottky Diode Ratings and Characteristics.....	6
3.3 Thermal and Package Characteristics.....	6
3.4 Typical SiC MOSFET Performance Curves.....	8
3.5 Typical SiC Diode Performance Curves.....	11
4 Package Specifications.....	12
4.1 Package Outline Drawing.....	12

1 Revision History

The revision history describes the changes that were implemented in the document. The changes are listed by revision, starting with the most current publication.

1.1 Revision 1.0

Revision 1.0 was published in April 2020. It is the first publication of this document.

2 Product Overview

The MSCSM70TAM10CTPAG device is a triple phase leg 700 V/238 A full silicon carbide (SiC) power module.

Figure 1 • MSCSM70TAM10CTPAG Electric Schematic

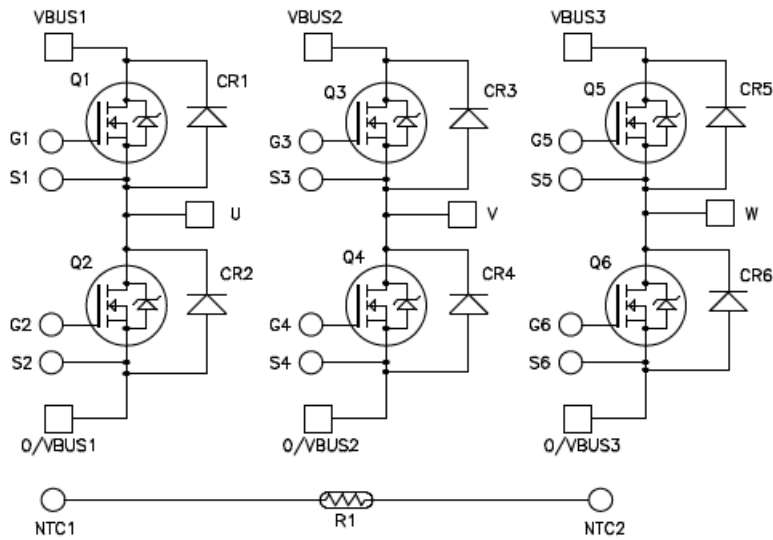
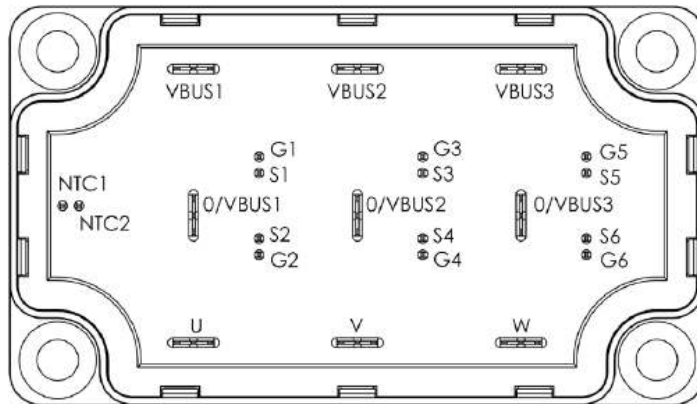

Figure 2 • MSCSM70TAM10CTPAG Pinout Location



All ratings at $T_j = 25\text{ }^\circ\text{C}$, unless otherwise specified.

Caution: These devices are sensitive to electrostatic discharge. Proper handling procedures should be followed.

2.1 Features

The following are key features of the MSCSM70TAM10CTPAG device:

- SiC Power MOSFET
 - Low $R_{DS(on)}$
 - High-speed switching
 - Ultra low loss
- SiC Schottky Diode
 - Zero reverse recovery
 - Zero forward recovery
 - Temperature independent switching behavior
 - Positive temperature coefficient on VF
- Very low stray inductance
- Kelvin source for easy drive
- Internal thermistor for temperature monitoring
- Aluminum nitride (AlN) substrate for improved thermal performance

2.2 Benefits

The following are benefits of the MSCSM70TAM10CTPAG device:

- High-efficiency converter
- Outstanding performance at high-frequency operation
- Direct mounting to heatsink (isolated package)
- Low junction-to-case thermal resistance
- Solderable terminals for power and signal, for easy PCB mounting
- Low profile
- RoHS compliant

2.3 Applications

The MSCSM70TAM10CTPAG device is designed for the following applications:

- Uninterruptible power supplies
- Switched mode power supplies
- EV motor and traction drive
- Welding converters

3 Electrical Specifications

This section shows the electrical specifications of the MSCSM70TAM10CTPAG device.

3.1 SiC MOSFET Characteristics (Per MOSFET)

The following table shows the absolute maximum ratings per SiC MOSFET of the MSCSM70TAM10CTPAG device.

Table 1 • Absolute Maximum Ratings

Symbol	Parameter	Max Ratings	Unit
V_{DSS}	Drain-source voltage	700	V
I_D	Continuous drain current	$T_C = 25\text{ }^\circ\text{C}$	238 ¹
		$T_C = 80\text{ }^\circ\text{C}$	189 ¹
I_{DM}	Pulsed drain current	476	
V_{GS}	Gate-source voltage	-10/25	V
$R_{DS(on)}$	Drain-source ON resistance	9.5	m Ω
P_D	Power dissipation	$T_C = 25\text{ }^\circ\text{C}$	674

Note:

1. Specification of the SiC MOSFET device, but output current must be limited due to size of power connectors.

The following table shows the electrical characteristics per SiC MOSFET of the MSCSM70TAM10CTPAG device.

Table 2 • Electrical Characteristics

Symbol	Characteristic	Test Conditions	Min	Typ	Max	Unit
I_{DSS}	Zero gate voltage drain current	$V_{GS} = 0\text{ V}$; $V_{DS} = 700\text{ V}$			200	μA
$R_{DS(on)}$	Drain-source on resistance	$V_{GS} = 20\text{ V}$ $I_D = 80\text{ A}$	$T_J = 25\text{ }^\circ\text{C}$	7.5	9.5	m Ω
			$T_J = 175\text{ }^\circ\text{C}$	9.5		
$V_{GS(th)}$	Gate threshold voltage	$V_{GS} = V_{DS}$, $I_D = 8\text{ mA}$	1.9	2.4		V
I_{GSS}	Gate-source leakage current	$V_{GS} = 20\text{ V}$, $V_{DS} = 0\text{ V}$			200	nA

The following table shows the dynamic characteristics per SiC MOSFET of the MSCSM70TAM10CTPAG device.

Table 3 • Dynamic Characteristics

Symbol	Characteristic	Test Conditions	Min	Typ	Max	Unit
C_{iss}	Input capacitance	$V_{GS} = 0\text{ V}$ $V_{DS} = 700\text{ V}$ $f = 1\text{ MHz}$		9000		pF
C_{oss}	Output capacitance			1020		
C_{rss}	Reverse transfer capacitance			58		
Q_g	Total gate charge	$V_{GS} = -5\text{ V}/20\text{ V}$ $V_{Bus} = 470\text{ V}$ $I_D = 80\text{ A}$		430		nC
Q_{gs}	Gate-source charge			116		
Q_{gd}	Gate-drain charge			70		
$T_{d(on)}$	Turn-on delay time	$V_{GS} = -5\text{ V}/20\text{ V}$ $V_{Bus} = 400\text{ V}$ $I_D = 160\text{ A}; T_J = 150\text{ }^\circ\text{C}$ $R_{Gon} = 13.5\text{ }\Omega; R_{Goff} = 2.4\text{ }\Omega$		40		ns
T_r	Rise time			35		
$T_{d(off)}$	Turn-off delay time			50		
T_f	Fall time			20		
E_{on}	Turn on energy	Inductive switching	$T_J = 150\text{ }^\circ\text{C}$	1090		μJ
E_{off}	Turn off energy	$V_{GS} = -5\text{ V}/20\text{ V}$ $V_{Bus} = 400\text{ V}$ $I_D = 160\text{ A}$ $R_{Gon} = 13.5\text{ }\Omega$ $R_{Goff} = 2.4\text{ }\Omega$	$T_J = 150\text{ }^\circ\text{C}$	372		μJ
R_{Gint}	Internal gate resistance			2.8		Ω
R_{thJC}	Junction-to-case thermal resistance				0.222	$^\circ\text{C}/\text{W}$

The following table shows the body diode ratings and characteristics per SiC MOSFET of the MSCSM70TAM10CTPAG device.

Table 4 • Body Diode Ratings and Characteristics

Symbol	Characteristic	Test Conditions	Min	Typ	Max	Unit
V_{SD}	Diode forward voltage	$V_{GS} = 0\text{ V}; I_{SD} = 80\text{ A}$		3.4		V
		$V_{GS} = -5\text{ V}; I_{SD} = 80\text{ A}$		3.8		
t_{rr}	Reverse recovery time	$I_{SD} = 80\text{ A}; V_{GS} = -5\text{ V}$ $V_R = 400\text{ V}; d_{iF}/dt = 2000\text{ A}/\mu\text{s}$		38		ns
Q_{rr}	Reverse recovery charge			636		nC
I_{rr}	Reverse recovery current				29.6	

3.2 SiC Schottky Diode Ratings and Characteristics

The following table shows the SiC Schottky diode ratings and characteristics of the MSCSM70TAM10CTPAG device.

Table 5 • SiC Schottky Diode Ratings and Characteristics (Per SiC Diode)

Symbol	Characteristic	Test Conditions		Min	Typ	Max	Unit
V_{RRM}	Peak repetitive reverse voltage					700	V
I_{RM}	Reverse leakage current	$V_R = 700\text{ V}$	$T_J = 25\text{ °C}$	30	400		μA
			$T_J = 175\text{ °C}$		500		
I_F	DC forward current				100		A
V_F	Diode forward voltage	$I_F = 100\text{ A}$	$T_J = 25\text{ °C}$	1.5	1.8		V
			$T_J = 175\text{ °C}$		1.9		
QC	Total capacitive charge	$V_R = 400\text{ V}$			266		nC
C	Total capacitance	$f = 1\text{ MHz}, V_R = 200\text{ V}$			496		μF
		$f = 1\text{ MHz}, V_R = 400\text{ V}$			432		
R_{thJC}	Junction-to-case thermal resistance					0.466	$^{\circ}\text{C/W}$

3.3 Thermal and Package Characteristics

The following table shows the package characteristics of the MSCSM70TAM10CTPAG device.

Table 6 • Thermal and Package Characteristics

Symbol	Characteristic			Min	Max	Unit
V_{ISOL}	RMS isolation voltage, any terminal to case $t = 1\text{ min}$, 50 Hz/60 Hz			4000		V
T_J	Operating junction temperature range			-40	175	$^{\circ}\text{C}$
T_{JOP}	Recommended junction temperature under switching conditions			-40	$T_{Jmax}-25$	
T_{STG}	Storage temperature range			-40	125	
T_C	Operating case temperature			-40	125	
Torque	Mounting torque	To heatsink	M6	3	5	N.m
Wt	Package weight				250	g

The following table shows the temperature sensor NTC (see application note [APT0406](#) on www.microsemi.com) of the MSCSM70TAM10CTPAG device.

Table 7 • Temperature Sensor NTC

Symbol	Characteristic	Min	Typ	Max	Unit
R ₂₅	Resistance at 25 °C		50		kΩ
ΔR ₂₅ /R ₂₅			5		%
B _{25/85}	T ₂₅ = 298.15 K		3952		K
ΔB/B			4		%
	T _C = 100 °C				

$$R_T = \frac{R_{25}}{\exp\left[B_{25/85}\left(\frac{1}{T_{25}} - \frac{1}{T}\right)\right]}$$

T: Thermistor temperature
R_T: Thermistor value at T

3.4 Typical SiC MOSFET Performance Curves

This sections shows the typical SiC MOSFET performance curves of the MSCSM70TAM10CTPAG device.

Figure 3 • Maximum Thermal Impedance

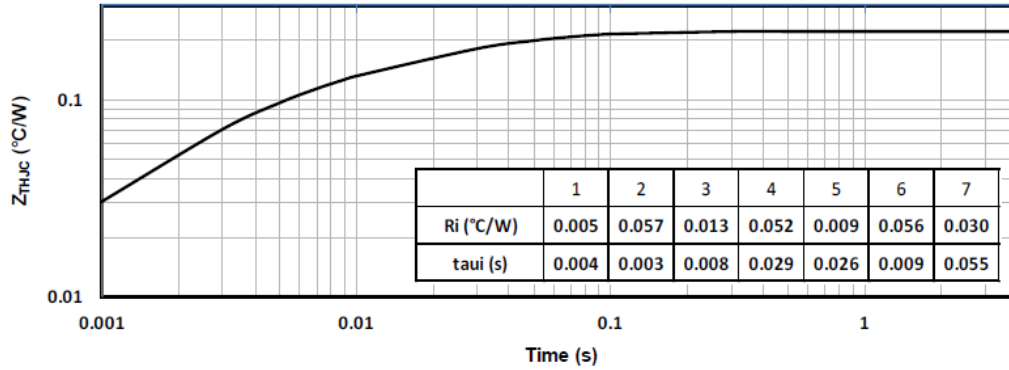

Figure 4 • Output Characteristics, T_J = 25 °C

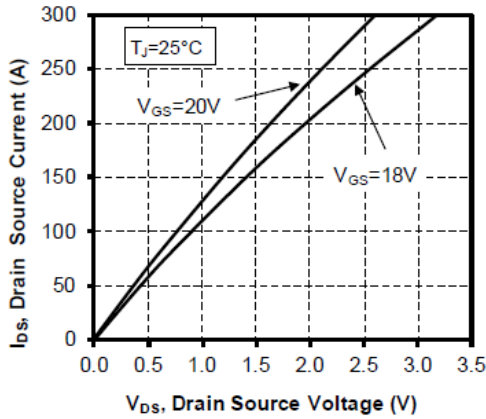

Figure 5 • Output Characteristics, T_J = 175 °C

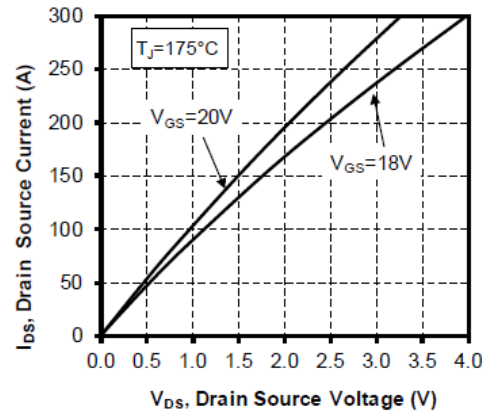

Figure 6 • Normalized R_{DS(on)} vs. Temperature

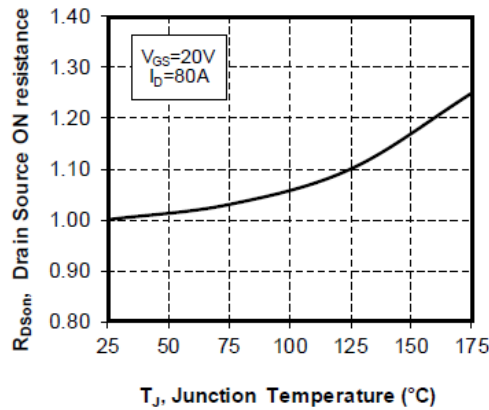

Figure 7 • Transfer Characteristics

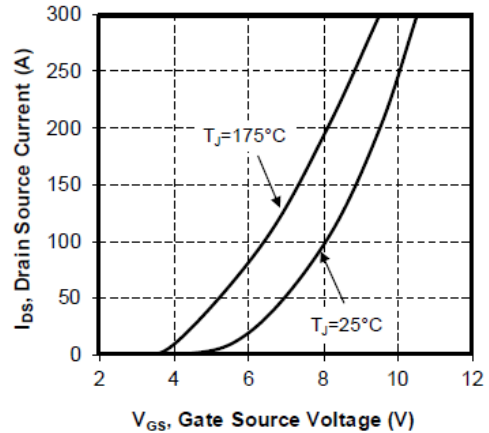

Figure 8 • Capacitance vs. Drain Source Voltage

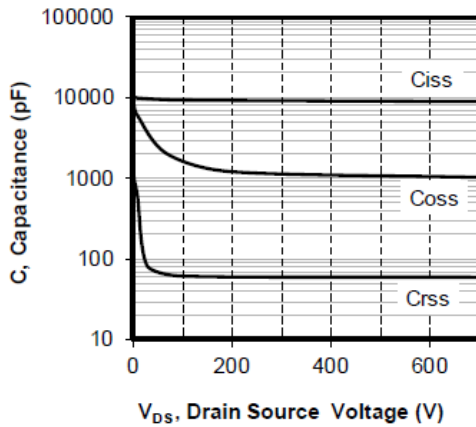

Figure 9 • Gate Charge vs. Gate Source Voltage

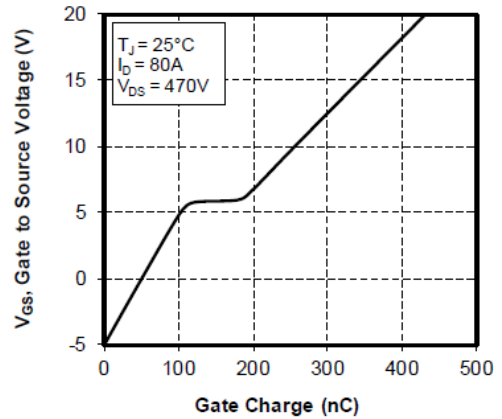

Figure 10 • Body Diode Characteristics, $T_J = 25^\circ\text{C}$

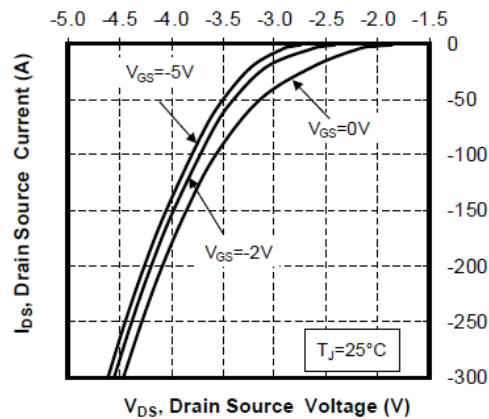

Figure 11 • 3rd Quadrant Characteristics, $T_J = 25^\circ\text{C}$

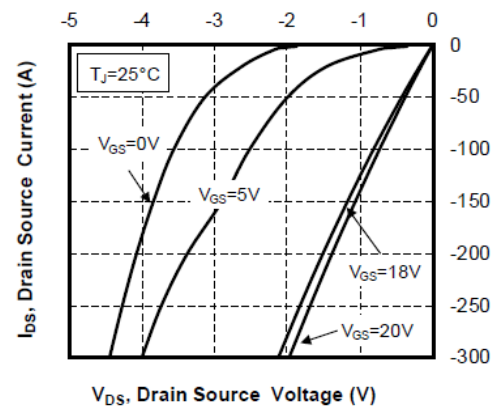

Figure 12 • Body Diode Characteristics, $T_J = 175^\circ\text{C}$

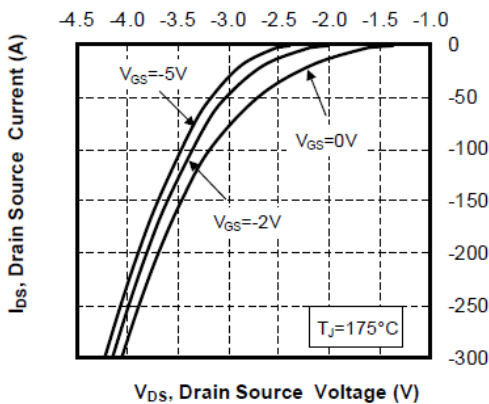

Figure 13 • 3rd Quadrant Characteristics, $T_J = 175^\circ\text{C}$

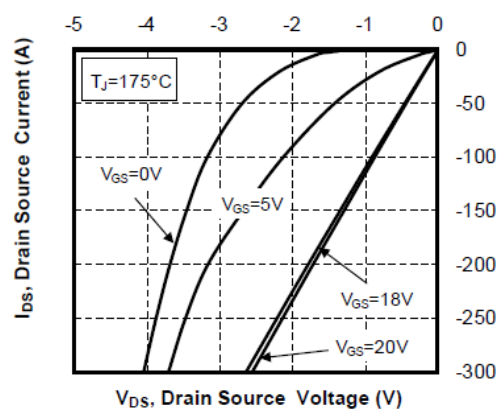

Figure 14 • Switching Energy vs. Current

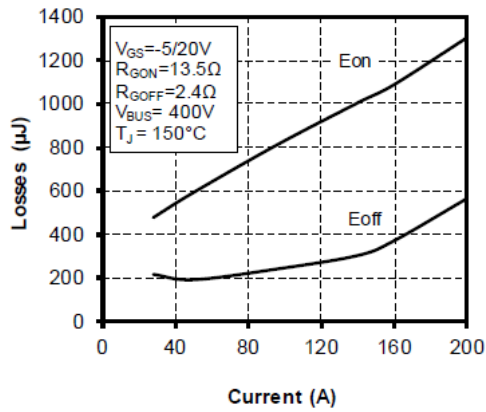

Figure 15 • Turn On Energy vs. Rg

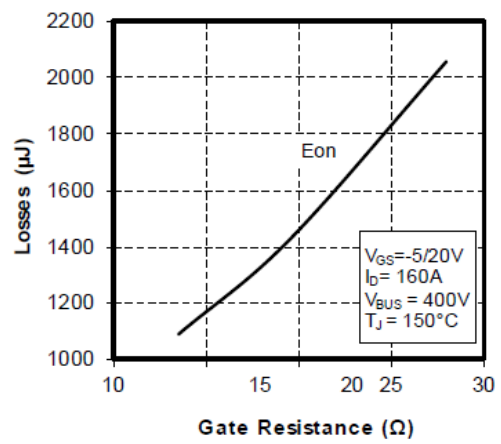

Figure 16 • Turn Off Energy vs. Rg

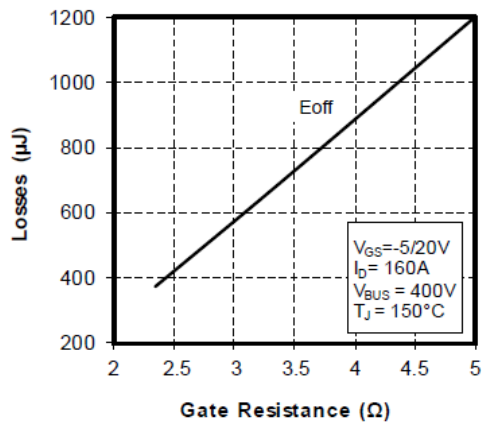
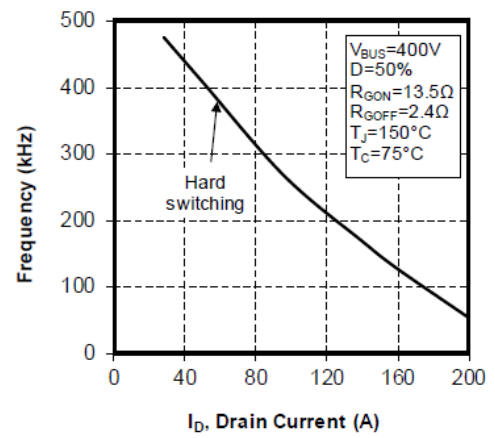

Figure 17 • Operating Frequency vs Drain Current



3.5 Typical SiC Diode Performance Curves

This sections shows the typical SiC diode performance curves of the MSCSM70TAM10CTPAG device.

Figure 18 • Maximum Thermal Impedance

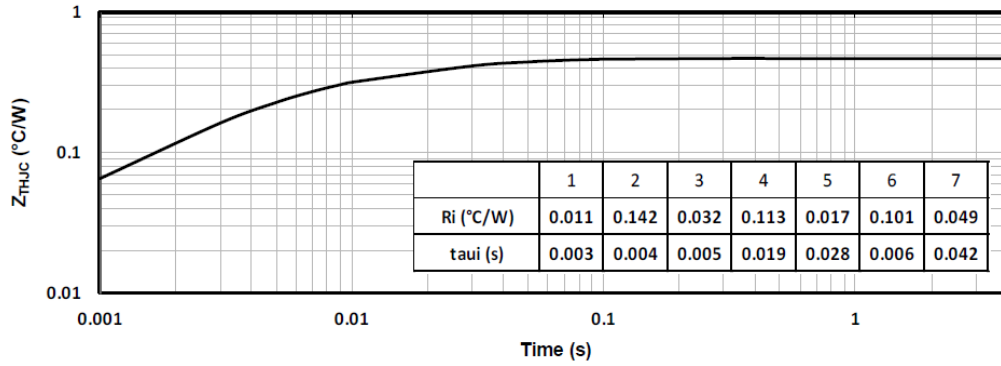

Figure 19 • Forward Characteristics

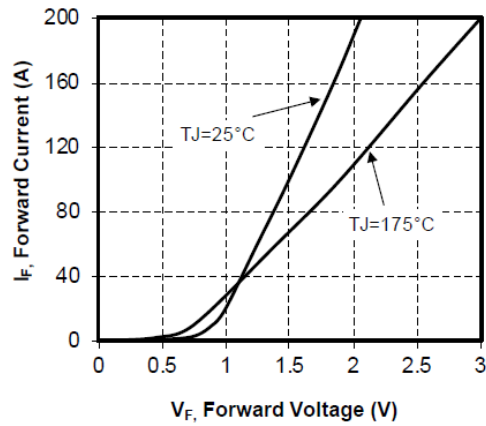
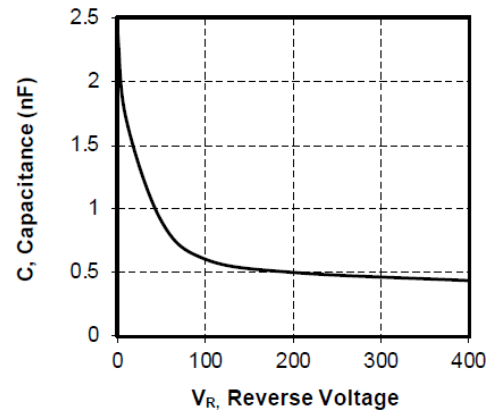

Figure 20 • Capacitance vs. Reverse Voltage



4 Package Specifications

This section shows the package specification of the MSCSM70TAM10CTPAG device.

4.1 Package Outline Drawing

This section shows the package outline drawing of the MSCSM70TAM10CTPAG device. The dimensions in the following figure are in millimeters.

Figure 21 • Package Outline Drawing

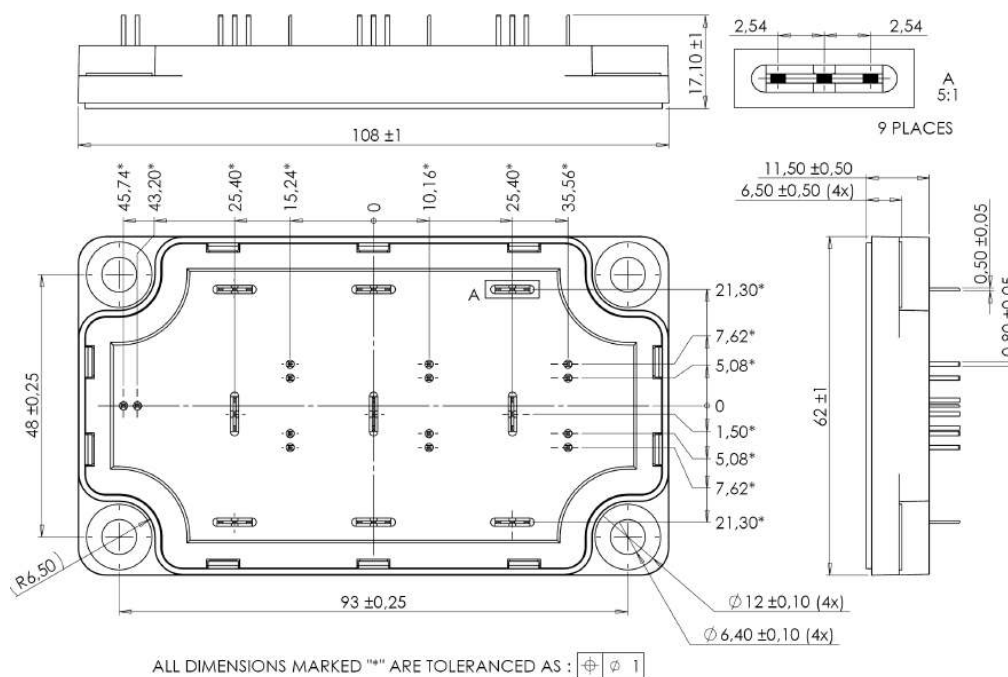

Note: See application note [1902 - Mounting Instructions for SP6-P \(12 mm\) Power Modules](#) on www.microsemi.com.

**Microsemi**

2355 W. Chandler Blvd.
 Chandler, AZ 85224 USA

Within the USA: +1 (480) 792-7200
 Fax: +1 (480) 792-7277

www.microsemi.com © 2020 Microsemi and its corporate affiliates. All rights reserved. Microsemi and the Microsemi logo are trademarks of Microsemi Corporation and its corporate affiliates. All other trademarks and service marks are the property of their respective owners.

Microsemi's product warranty is set forth in Microsemi's Sales Order Terms and Conditions. Information contained in this publication is provided for the sole purpose of designing with and using Microsemi products. Information regarding device applications and the like is provided only for your convenience and may be superseded by updates. Buyer shall not rely on any data and performance specifications or parameters provided by Microsemi. It is your responsibility to ensure that your application meets with your specifications. THIS INFORMATION IS PROVIDED "AS IS." MICROSEMI MAKES NO REPRESENTATIONS OR WARRANTIES OF ANY KIND WHETHER EXPRESS OR IMPLIED, WRITTEN OR ORAL, STATUTORY OR OTHERWISE, RELATED TO THE INFORMATION, INCLUDING BUT NOT LIMITED TO ITS CONDITION, QUALITY, PERFORMANCE, NON-INFRINGEMENT, MERCHANTABILITY OR FITNESS FOR A PARTICULAR PURPOSE. IN NO EVENT WILL MICROSEMI BE LIABLE FOR ANY INDIRECT, SPECIAL, PUNITIVE, INCIDENTAL OR CONSEQUENTIAL LOSS, DAMAGE, COST OR EXPENSE WHATSOEVER RELATED TO THIS INFORMATION OR ITS USE, HOWEVER CAUSED, EVEN IF MICROSEMI HAS BEEN ADVISED OF THE POSSIBILITY OR THE DAMAGES ARE FORESEEABLE. TO THE FULLEST EXTENT ALLOWED BY LAW, MICROSEMI'S TOTAL LIABILITY ON ALL CLAIMS IN RELATED TO THIS INFORMATION OR ITS USE WILL NOT EXCEED THE AMOUNT OF FEES, IF ANY, YOU PAID DIRECTLY TO MICROSEMI FOR THIS INFORMATION. Use of Microsemi devices in life support, mission-critical equipment or applications, and/or safety applications is entirely at the buyer's risk, and the buyer agrees to defend and indemnify Microsemi from any and all damages, claims, suits, or expenses resulting from such use. No licenses are conveyed, implicitly or otherwise, under any Microsemi intellectual property rights unless otherwise stated.

Microsemi Corporation, a subsidiary of Microchip Technology Inc. (Nasdaq: MCHP), and its corporate affiliates are leading providers of smart, connected and secure embedded control solutions. Their easy-to-use development tools and comprehensive product portfolio enable customers to create optimal designs which reduce risk while lowering total system cost and time to market. These solutions serve more than 120,000 customers across the industrial, automotive, consumer, aerospace and defense, communications and computing markets. Headquartered in Chandler, Arizona, the company offers outstanding technical support along with dependable delivery and quality. Learn more at www.microsemi.com.

MSCC-0344-DS-01081