

Corporate Headquarters:  
Wakefield Engineering Inc.\*  
33 Bridge Street, Pelham, NH 03076  
Tel: 603-635-2800 • Fax: 603-635-1900  
\* ISO 9001:2015 REGISTERED

**THERMAL MANAGEMENT**  
Standard Product Catalog

**2018**

## TABLE OF CONTENTS

<b>Wakefield-Vette Summary</b> .....	2
<b>Location Overview</b> .....	3
<b>Design Services</b> .....	4
<b>BGA Thermal Solutions Matrix</b> .....	7
<b>Thermal Interface Material Part Number Guide</b> .....	8
<b>Integrated Circuit Cooling Heat Sinks &amp; Fan Heat Sinks</b> .....	10-43
Heat sinks for microprocessors, ASICs, SRAM, BGAs, multichip modules, and other integrated circuits.	
<b>Board Level Power Semiconductor Heat Sinks</b> .....	44-85
A wide variety of heat dissipators with various attachment mechanisms for surface mount and thru-hole power semiconductors packaged in industry standard plastic, ceramic, and metal cases such as D <sup>2</sup> Pak, TO-220, TO-3 to TO-247, DO-4 to DO-11, multiwatt, hex-type, and stud mount devices.	
<b>Extruded Heat Sinks</b> .....	86-97
For cooling single and multiple high power devices packaged in industry standard semiconductor case styles: TO-3 to TO-247, DO-4 to DO-30, hex-type, and stud mount; press pack devices; power modules; SCRs, IGBTs; I/O devices; and other isolated flat base devices in both natural and forced convection.	
<b>Bonded Fin Heat Sinks</b> .....	98-105
A variety of Natural Convection, Forced Convection, and Custom Bonded Fin Assemblies.	
<b>Precision Compression Clamp Systems</b> .....	106-113
Mounting clamps for compression-type devices to 5,250 in. (133.4 mm) diameter and clamp force requirements ranging from 800 lbs. (262.9 kg) to 16,000 lbs. (7257.5 kg). A wide variety of Press Pack Heat Sinks are offered that are compatible with these mounting clamp series.	
<b>Liquid Cooling</b> .....	114-123
For higher power applications where conventional cooling is no longer acceptable.	
<b>Phase Change</b> .....	124-137
<b>Thermal Interface Products</b> .....	138-155
Cost-effective accessory products that facilitate installation and improve the thermal performance of both standard and custom heat dissipation components. Included are thermal joint compounds; filled epoxy systems; adhesives; thermally conductive insulating wafers, washers, pads and mounting hardware.	
<b>Mil Embedded</b> .....	156-161
<b>Electronics Packaging</b> .....	162-169
<b>Thermal Extrusion Profiles</b> .....	170-277
Flatback Extrusions .....	172-234
L-style Extrusions .....	235-239
Center Channel Extrusions .....	239-245
Multi Channel Extrusions .....	245-247
Flatback with Integral Mounting Feet .....	248-252
T-style Extrusions .....	252-256
H-style Extrusions .....	256-262
Double-Sided Extrusions .....	262-263
Mounting Shelf Extrusions .....	263-265
Press Pack Extrusions .....	265-268
Power Module Extrusions .....	268-269
Forced Convection Extrusions .....	269-271
Modular Extrusions/Enclosures .....	271-272
Hollow Extrusions .....	272-273
Miscellaneous Extrusions .....	273-276
<b>High Aspect Ratio Thermal Extrusions</b> .....	278-287
<b>Part Number Reference Guide &amp; Profile Number Reference Guide</b> .....	288-293
<b>Glossary of Terms</b> .....	293-294

Wakefield-Vette believes that information provided in this product catalog is accurate as of publication date. Product testing for proper performance in customer applications is recommended for all component designs and adhesives. Obtain mechanical samples of all assembly components and test to determine suitability. The physical properties reported herein are representative of performance values obtained by standard predictive and testing methods and exclude the interface resistance of any adhesive or other interface material in heat sink data. Wakefield-Vette is a manufacturer of heat dissipation products and reserves the right to make changes to its products without notice to improve the design or performance characteristics.

All trademarks and tradenames used in this publication are for identification purposes only and may be trademarks of their respective companies.

All specifications subject to change without notice. © 2018



## ABOUT WAKEFIELD-VETTE

### SINCE 1952

**Wakefield-Vette** has been in continuous operations since 1952, providing thermal solutions across multiple industries, from international Fortune 50 companies to small and medium sized businesses. Industries served include *Power Conversion, Information Technology, Renewable Energy, Telecommunications, Transportation, Aerospace/Defense, LED Lighting, Factory Automation, Consumer, and Medical.*

The thermal solutions Wakefield-Vette manufactures comprise a wide array of products, including *thermal extrusions, LED heat sinks, heat frames and pipes, fans, heat exchangers, coolant distribution units, liquid cold plates, etc.*, making Wakefield-Vette unique in its ability to deliver the increasingly complex **thermal solutions** required to meet the thermal engineering challenges of today's ever-higher electronics packaging densities.

Wakefield-Vette is a **700-employee strong company** with 500,000 square feet of global manufacturing capacity with facilities located in New Hampshire, North Carolina, and Wisconsin.



### PELHAM, NH

*US Headquarters Production – Thermal Management, Extrusions*

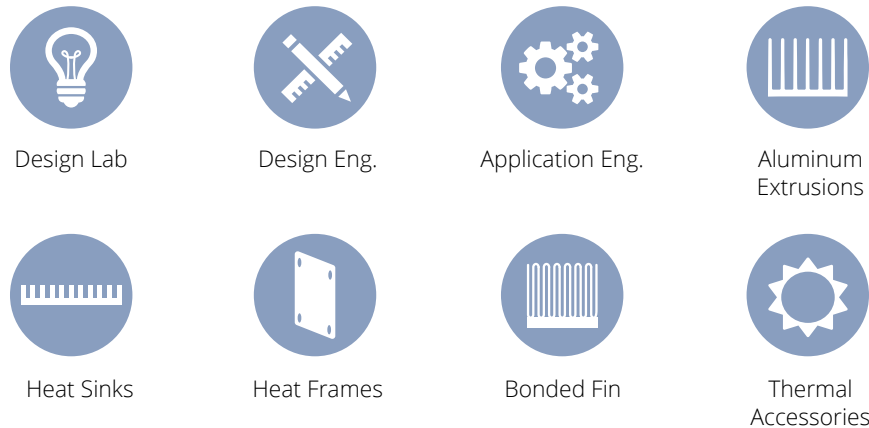

**33 Bridge Street  
Pelham, NH 03076**  
**Phone:** (603) 635-2800  
**Fax:** (603) 635-1900

210 Employees  
240,000 ft<sup>2</sup>

## LOCATION OVERVIEW

### RALEIGH, NC

*Production – Ruggedized & Electronic Packaging, Hi-end Complex Mfg, Military*

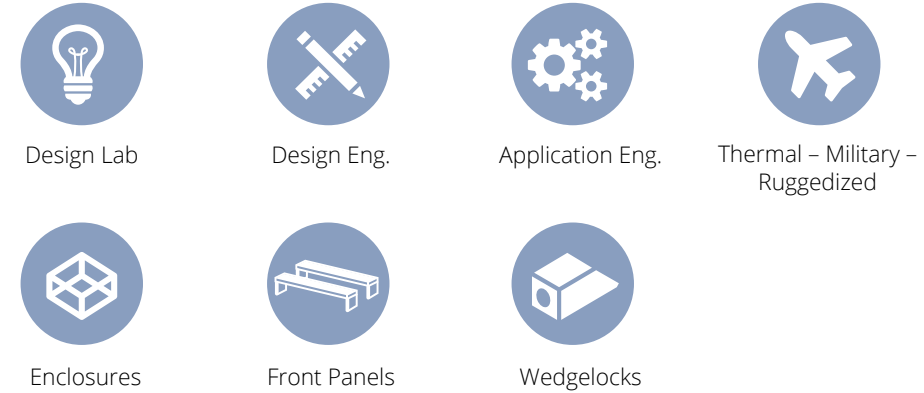

**2910 Industrial Drive  
Raleigh, NC 27609**  
**Phone:** (919) 831-9950

65 Employees  
50,000 ft<sup>2</sup>

### WITHEE, WI

*Production – Extrusions, Fabrications*



**511 Progress Street  
Withee, WI 54498**  
**Phone:** (715) 229-9200  
**Fax:** (715) 229-9202

60 Employees  
55,000 ft<sup>2</sup>

# DESIGN SERVICES

## THERMAL SOLUTIONS

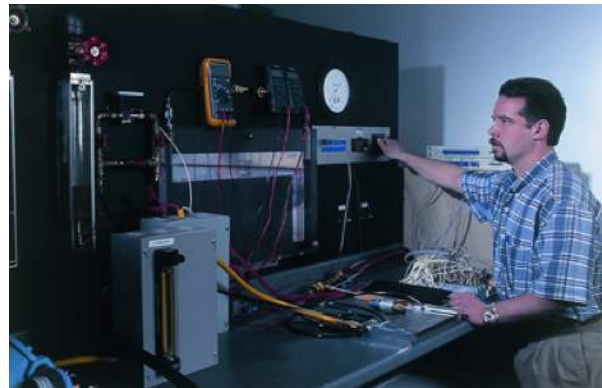
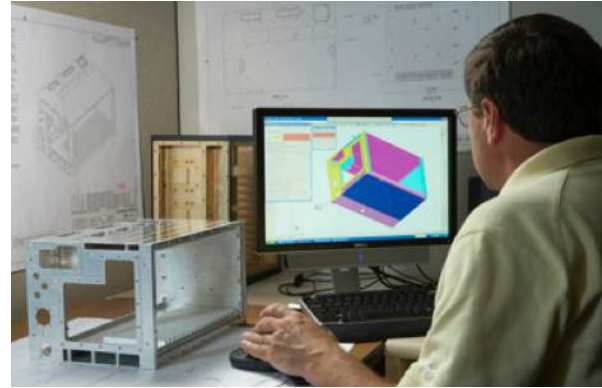
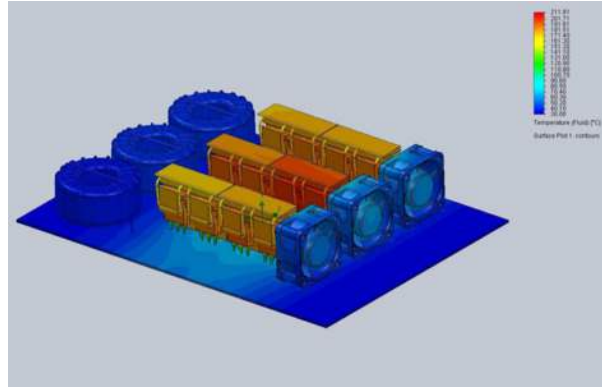

Wakefield-Vette also offers a **wide range of engineering design services** along with our standard and custom products. In many cases, our customers need to make small changes to our standard products. Wakefield-Vette's application engineers are ready to modify drawings and give feedback on requested changes to support your efforts to make the product you purchase work as intended in your application. When even more design assistance is needed, Wakefield-Vette has a world class team of engineers to work with you. We excel at collaboration with **engineering teams** to share drawings, design ideas, analysis and manufacturing understanding. Wakefield-Vette uses SolidWorks solid models and drawings and Ansys IcePak for Computational Fluid Dynamics (CFD) analysis.

Even if you do not have a thermal solution in mind, bring your applications to us and we can support ground-up design efforts with options for **liquid, natural and forced air convection cooling solutions**. Wakefield-Vette can also give insight into the use of thermal products like heat pipes, vapor chambers, liquid cold plates and many other technologies to bring to bear on your application as well as accessory items such as thermal interface materials, fans and attach methods. Wakefield-Vette can truly be your one-stop-shop for thermal solutions from start to finish.

# NOTES

Lined area for taking notes.

# THERMAL MANAGEMENT SOLUTIONS & THERMAL INTERFACE

*Thermal Management Solutions for BGAs*..... 7  
*Thermal Interface* ..... 8

## BGA THERMAL SOLUTIONS MATRIX

The following table represents Wakefield-Vette’s recommendations for a variety of standard BGA sizes. However, this is by no means a complete list of components that can be used with these heat sinks. To determine suitability for your particular component, request a BGA heat sink evaluation kit.

BGA Sizes (mm)	Heat Sink Footprint (mm)	Heat Sink Height (inches)	Recommended Series #	Attachment Method
17	17 x 17	.40	D10650	Adhesive
19	19 x 19	1.00	602	Adhesive
21	21 x 21	.40	D10850	Adhesive
21	21 x 21	.25 .35 .45 .60	624	Adhesive
23	22 x 22	.40 .60	604	Adhesive
23	22 x 22	.75	605	Adhesive
25	25 x 25	.25 .35 .45 .60	625	Adhesive
27	28 x 28	.25 .35 .45 .60	658	Adhesive
29	30 x 30	.77	606	Adhesive
31	31 x 28	.65	607	Adhesive
31	31 x 31	.80	611	Adhesive
33	32 x 32	.35 .40	610	Adhesive
35	35 x 35	.65	612	Adhesive
35	35 x 35	.25 .35 .45 .60	642	Adhesive
35	35 x 35	.25 .35 .45 .60	630	Adhesive
37.5	37 x 37	.50	613	Adhesive
37.5	37 x 37	.65	659	Adhesive
45.7 x 35.5	37 x 47	.80	617	Adhesive
40	38 x 38	.30 .50 1.00	614	Adhesive
37.5	38 x 38	.29	660	Adhesive
40	40 x 28	.35	643	Clip
40	40 x 40	.26 .53	655	Adhesive
42.5	41 x 41	.41	615	Adhesive
45	43 x 43	.20 .25 .35 .45 .60	628	Adhesive
45	43 x 43	.15	662	Adhesive
47.5	47 x 47	.80	616	Adhesive
50	50 x 50	.40 .65 .80 1.00	698	Adhesive
50	51 x 51	.20 1.00	618	Adhesive
50	52 x 51	.80	622	Adhesive
50	53 x 47	.40 .65 .80 1.00	798	Adhesive
50	64 x 51	.24	620	Adhesive
up to 45	73 x 50	.50 1.00	609	Clip
up to 45	73 x 50	.95	619	Clip

### RoHS COMPLIANCE

Please note that Wakefield-Vette part numbers designated with an “E” in this catalog denote new parts in compliance with the RoHS initiative, with the exception of our Precision Clamps. Wakefield-Vette will still continue to offer non-RoHS compliant versions of these parts. Please be aware that many Wakefield-Vette Standard parts have always been compliant since their design inception and therefore will not carry the “E” designation.

Wakefield-Vette requests that you refer to the RoHS compliance tool on our website at [www.wakefield-vette.com](http://www.wakefield-vette.com) to verify RoHS compliance. If you require further clarification or information regarding RoHS, please contact the factory.



## THERMAL INTERFACE MATERIAL PART NUMBER GUIDE

All of the heat sinks shown in this catalog are available with any of the following thermal tape and interface materials, pre-applied at the factory. Use the “T” series, thermally enhanced, pressure sensitive adhesives to attach the heat sink to the electronic package and provide a good thermal link to the heat sink. Specify these materials in applications where the heat sink will be fixed to the electronic package by some mechanical means other than a tape. Please note that none of these materials are for use in applications requiring electrical isolation from the electronic device. All options other than -T1 and -T4 are RoHS compliant.

**Note:** To obtain the estimated thermal resistance of the interface material in your application, divide the thermal impedance value by the area of the pad in square inches. For example, a 2” x 2” piece of T4 has a resistance of 1.10 C-in<sup>2</sup>/W ÷ 4 in<sup>2</sup>=0.275 C/W

### “T” Series Thermally Enhanced Pressure Sensitive Adhesives

Suffix	Manufacturer Product	Thermal Impedance C-in <sup>2</sup> /W	Thickness, Inches	Package Surface, Comments
-T1	Chomerics, T405	0.47	0.006	Metal/ceramic; aluminum carrier
-T1E	Chomerics, T405R	0.47	0.006	RoHS-compliant version of -T1
-T3	Chomerics, T412	0.25	0.009	Metal/ceramic; very good performance and conformity
-T4	Chomerics, T410	1.10	0.007	Plastic
-T4E	Chomerics, T410R	1.10	0.007	RoHS-compliant version of -T4
-T5	Chomerics, T411	1.00	0.011	Plastic; conforms to out-of-flat packages
-T6	3M, 8810	0.88	0.010	Metal/ceramic; very good adhesion and conformity
-T7	Bergquist, BP 108	1.28	0.008	Metal/ceramic; electrically insulating

### ORDERING INFORMATION

Once you have chosen heat sink and thermal interface material that meets your thermal & mechanical requirements it is easy to designate the part number. Simply add the interface material suffix referenced on the chart above to the base part number for the heat sink. The base part number already includes information regarding its size and finish.

Example:

To order the 658 Series heat sink at .350” tall with the T5 thermal interface material, specify part number:

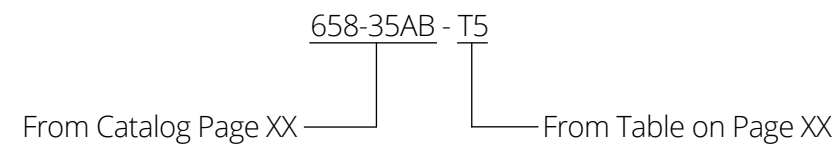



# INTEGRATED CIRCUIT COOLING HEAT SINKS

<i>Heat Sinks For BGAs, Super BGAs, &amp; FPBGAs .....</i>	<i>12-27</i>
<i>Deltem™ Composite Heat Sinks For BGAs .....</i>	<i>18</i>
<i>Heat Sinks For Microprocessors &amp; ASICs.....</i>	<i>28-30</i>
<i>Pin Fin Heat Sinks .....</i>	<i>31</i>
<i>Elliptical Fin Heat Sinks.....</i>	<i>32</i>
<i>Pin Fin &amp; Elliptical Fin Heat Sinks .....</i>	<i>33</i>
<i>Ceramic Heat Sink For To Devices w/ OmniKlip .....</i>	<i>34-35</i>
<i>Wave Series Heat Sink With Integrated Clip Assembly .....</i>	<i>36-43</i>

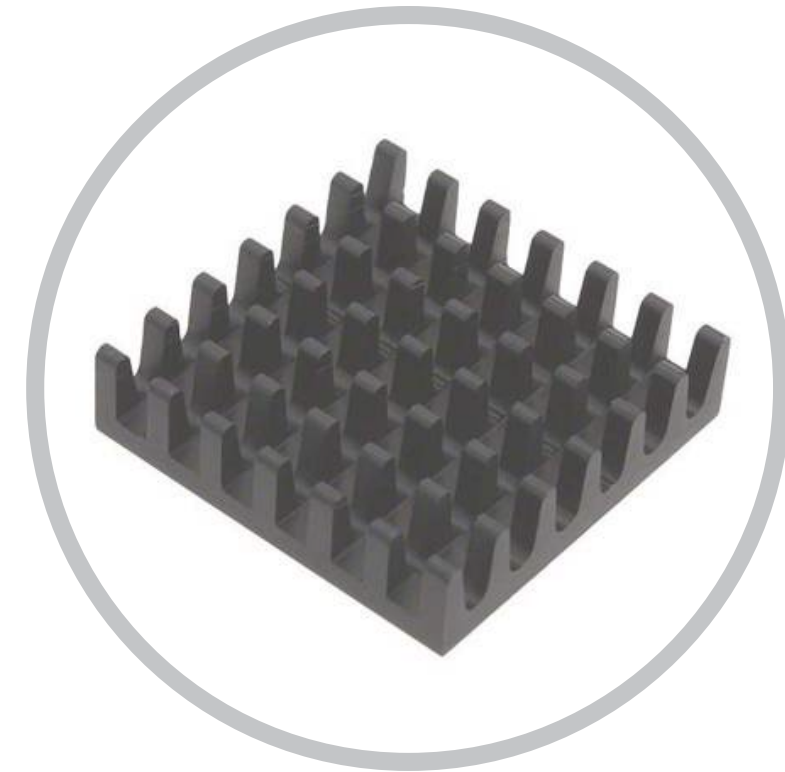

*With the increase in heat dissipation from microelectronics devices and the reduction in overall form factors, thermal management becomes a more important element of electronic product design.*

*Both the performance reliability and life expectancy of electronic equipment are inversely related to the component temperature of the equipment. The relationship between the reliability and the operating temperature of a typical silicon semi-conductor device shows that a reduction in the temperature corresponds to an exponential increase in the reliability and life expectancy of the device. Therefore, long life and reliable performance of a component may be achieved by effectively controlling the device operating temperature within the limits set by the device design engineers.*

*Heat sinks are devices that enhance heat dissipation from a hot surface, usually the case of a heat generating component, to a cooler ambient, usually air. For the following discussions, air is assumed to be the cooling fluid. In most situations, heat transfer across the interface between the solid surface and the coolant air is the least efficient within the system, and the solid-air interface represents the greatest barrier for heat dissipation. A heat sink lowers this barrier mainly by increasing the surface area that is in direct contact with the coolant. This allows more heat to be dissipated and/or lowers the device operating temperature. The primary purpose of a heat sink is to maintain the device temperature below the maximum allowable temperature specified by the device manufacturers.*

## HEAT SINKS FOR BGAs, SUPER BGAs, PBGAs, & FPBGAs

### 624 SERIES OMNIDIRECTIONAL PIN FIN HEAT SINK FOR BGAs



The **624 Series** is an omnidirectional pin fin heat sink for both natural and forced-convection applications.

Applications include network routers and switches, high-resolution printers, digital cameras, consumer video games, digital video disks (DVD) and global positioning systems (GPS).

Standard P/N	Base Dimensions in. Sq.	Fin Height "A" in. (mm)	Typical Applications	Weight lbs. (grams)
624-25AB	.827 (21)	.250 (6.4)	21mm BGA	.009 (4.09)
624-35AB	.827 (21)	.350 (8.9)	21mm BGA	.011 (4.99)
624-45AB	.827 (21)	.450 (11.4)	21mm BGA	.015 (6.81)
624-60AB	.827 (21)	.600 (15.2)	21mm BGA	.026 (11.80)

**Material:** Aluminum, Black Anodized

#### PRODUCT FEATURES

- Available in four standard heights, .25 inch, .35 inch, .45 inch, and .60 inch.
- Available with pressure sensitive adhesives for quick and easy mounting. See Page 8.

#### 624 THERMAL PERFORMANCE

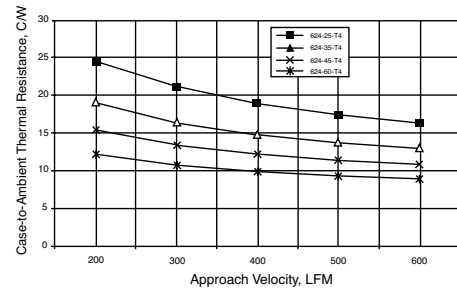

#### MECHANICAL DIMENSIONS

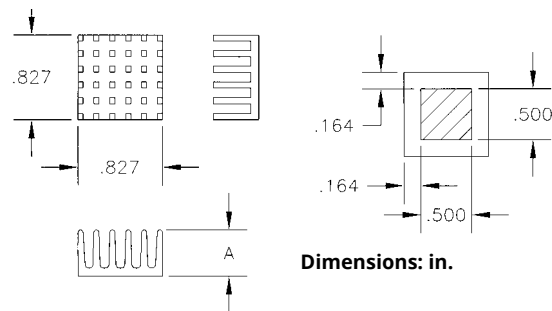

### OMNIDIRECTIONAL PIN FIN HEAT SINK FOR BGAs **625 SERIES**

#### PRODUCT FEATURES

- Available in four standard heights, .25 inch, .35 inch, .45 inch, and .60 inch.
- Available with pressure sensitive adhesives for quick and easy mounting. See Page 8.

The **625 Series** is an omnidirectional pin fin heat sink for both natural and forced-convection applications.

Applications include network routers and switches, high-resolution printers, digital cameras, consumer video games, digital video disks (DVD) and global positioning systems (GPS).

Standard P/N	Base Dimensions in. Sq.	Fin Height "A" in. (mm)	Typical Applications	Weight lbs. (grams)
625-25AB	.984 (25)	0.250 (6.4)	25 mm BGA	.012 (5.45)
625-35AB	.984 (25)	0.350 (8.9)	25 mm BGA	.014 (6.36)
625-45AB	.984 (25)	0.450 (11.4)	25 mm BGA	.018 (8.17)
625-60AB	.984 (25)	0.600 (15.2)	25 mm BGA	.030 (13.62)

**Material:** Aluminum, Black Anodized

#### 625 THERMAL PERFORMANCE

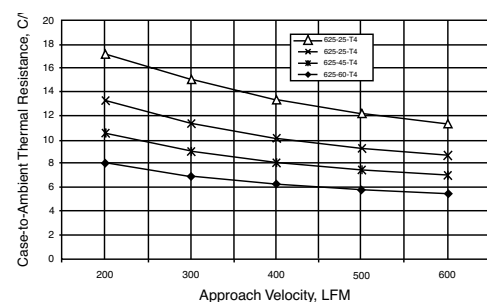

#### MECHANICAL DIMENSIONS

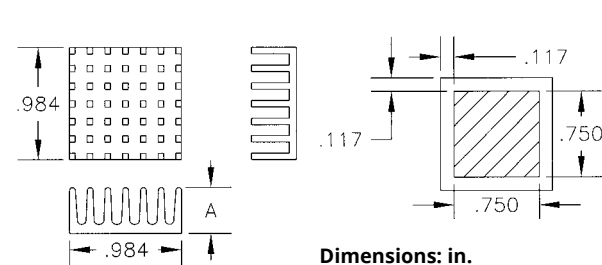

### UNIDIRECTIONAL FIN HEAT SINK FOR BGAs **659 SERIES**



Standard P/N	Base Dimensions in. (mm)	Height in. (mm)	Typical Application	Heat Sink Finish	Weight lbs. (grams)
659-65AB	1.45 (36.8) sq0	.650 (16.5)	37mm BGA	Black Anodized	0.050 (22.68)

**Notes:** 1. Optional factory pre-applied pressure-sensitive adhesive. See Page 8.

#### MECHANICAL DIMENSIONS

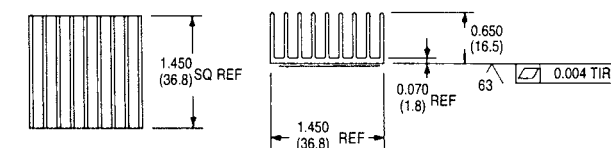

Dimensions: in. (mm)

#### NATURAL AND FORCED CONVECTION CHARACTERISTICS

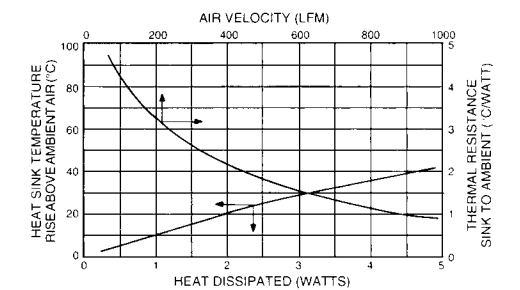

### OMNIDIRECTIONAL PIN FIN HEAT SINK FOR BGAs AND POWERPC™ **655 SERIES**

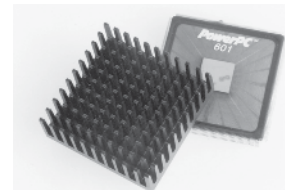

Standard P/N	Base Dimensions in. (mm)	Dimension "A" in. (mm)	Dimension "B" in. (mm)	Typical Applications	Heat Sink Finish	Weight lbs. (grams)
655-26AB	1.600 (40.6) sq	0.260 (6.6)	0.125 (3.2)	40mm BGA	Black Anodized	0.038 (17.01)
655-53AB	1.600 (40.6) sq	0.525 (13.3)	0.145 (3.7)	40mm BGA	Black Anodized	0.050 (22.68)

**Notes:** 1. Optional factory pre-applied pressure-sensitive adhesive. See Page 8.

#### MECHANICAL DIMENSIONS

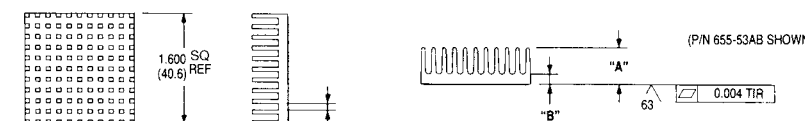

Dimensions: in. (mm)

#### NATURAL AND FORCED CONVECTION CHARACTERISTICS

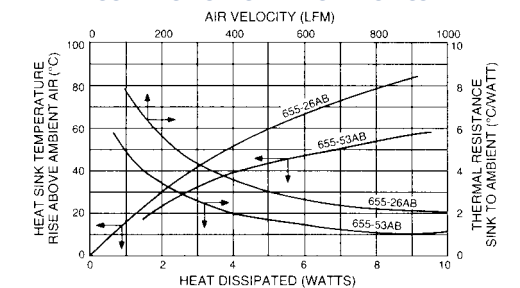

### OMNIDIRECTIONAL PIN FIN HEAT SINK FOR BGAs AND POWERPC™ **658 SERIES**

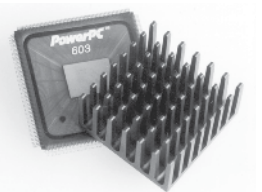

Standard P/N	Base Dimensions in. (mm)	Dimension "A" in. (mm)	Typical Applications	Heat Sink Finish	Weight lbs. (grams)
658-25AB	1.100 (27.9) sq	0.250 (6.4)	27mm BGA	Black Anodized	0.013 (5.67)
658-35AB	1.100 (27.9) sq	0.350 (8.9)	27mm BGA	Black Anodized	0.015 (6.70)
658-45AB	1.100 (27.9) sq	0.450 (11.4)	27mm BGA	Black Anodized	0.019 (8.50)
658-60AB	1.100 (27.9) sq	0.600 (15.2)	27mm BGA	Black Anodized	0.031 (14.17)

**Notes:** 1. Optional factory pre-applied pressure-sensitive adhesive. See Page 8.

#### MECHANICAL DIMENSIONS

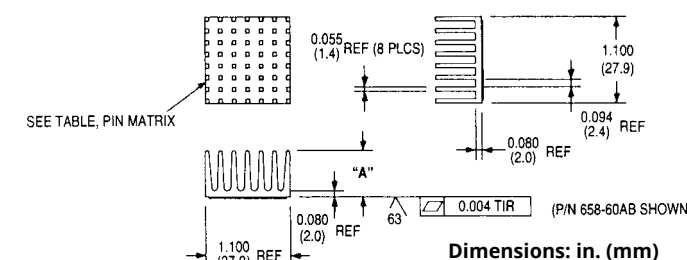

Dimensions: in. (mm)

#### NATURAL AND FORCED CONVECTION CHARACTERISTICS

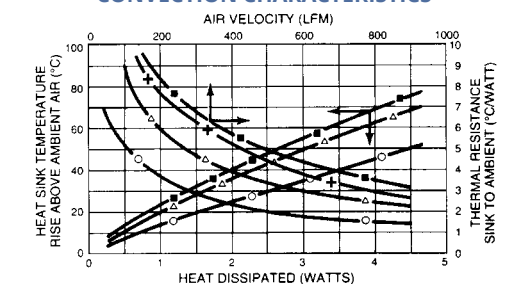

KEY:  
 ■ 658-25AB  
 + 658-35AB  
 △ 658-45AB  
 ○ 658-60AB

## HEAT SINKS FOR BGAs, SUPER BGAs, PBGAs, & FPBGAs

### 660 SERIES

UNIDIRECTIONAL FIN HEAT SINK FOR BGAs

Standard P/N	Base Dimensions in. (mm)	Height in. (mm)	Typical Application	Heat Sink Finish	Weight lbs. (grams)
660-29AB	1.530SQ. (38.9)SQ.	0.285 (7.2)	37mm BGA	Black Anodized	0.031 (14.17)

Notes: 1. Optional factory pre-applied pressure-sensitive adhesive. See Page 8.

#### MECHANICAL DIMENSIONS

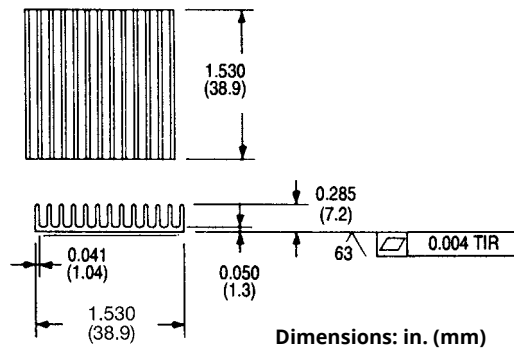

#### NATURAL AND FORCED CONVECTION CHARACTERISTICS

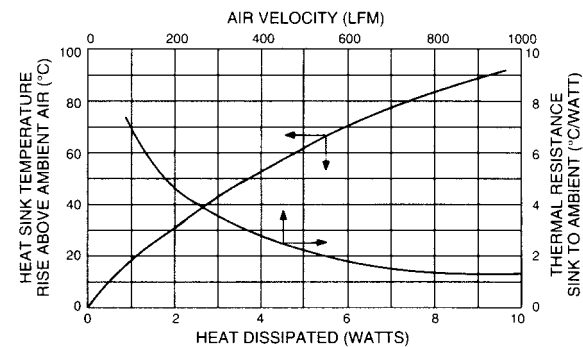

### UNIDIRECTIONAL FIN HEAT SINK FOR BGAs

### 642 SERIES

#### PRODUCT FEATURES

- Available in four standard heights, .25 inch, .35 inch, .45 inch, and .60 inch.
- Available with pressure sensitive adhesives for quick and easy mounting. See Page 8.

The **642 Series** is an unidirectional pin fin heat sink for both natural and forced-convection applications.

Applications include network routers and switches, high-resolution printers, digital cameras, consumer video games, digital video disks (DVD) and global positioning systems (GPS).

Standard P/N	Base Dimensions in. Sq.	Fin Height "A" in. (mm)	Typical Applications	Weight lbs. (grams)
642-25AB	1.378 (35)	.250 (6.4)	35 mm BGA	.022 (9.99)
642-35AB	1.378 (35)	.350 (8.9)	35 mm BGA	.027 (12.26)
642-45AB	1.378 (35)	.450 (11.4)	35 mm BGA	.031 (14.07)
642-60AB	1.378 (35)	.600 (15.2)	35 mm BGA	.039 (17.71)

Material: Aluminum, Black Anodized

#### MECHANICAL DIMENSIONS

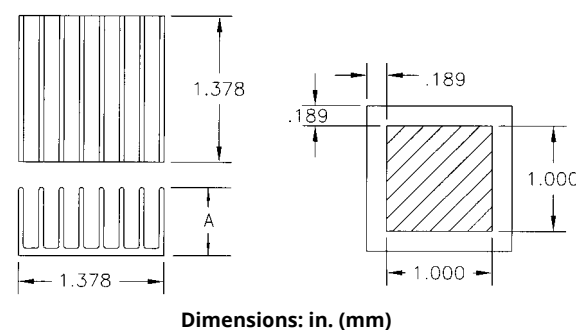

#### 642 THERMAL PERFORMANCE

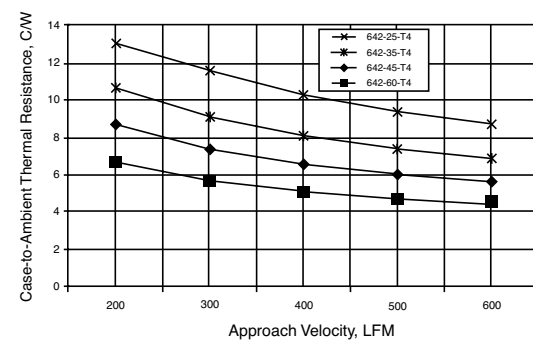

### OMNIDIRECTIONAL PIN FIN HEAT SINK FOR LIMITED HEIGHT BGAs

### 662 SERIES

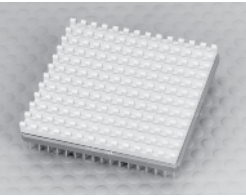

Standard P/N	Base Dimensions in. (mm)	Height in. (mm)	Typical Applications	Heat Sink Finish	Weight lbs. (grams)
662-15AG	1.713 (43.5) sq	0.150 (3.8)	45mm BGA	Gold Iridite	0.019 (8.50)
662-15AB	1.713 (43.5) sq	0.150 (3.8)	45mm BGA	Black Anodized	0.019 (8.50)

Notes: 1. Optional factory pre-applied pressure-sensitive adhesive. See Page 8.

#### MECHANICAL DIMENSIONS

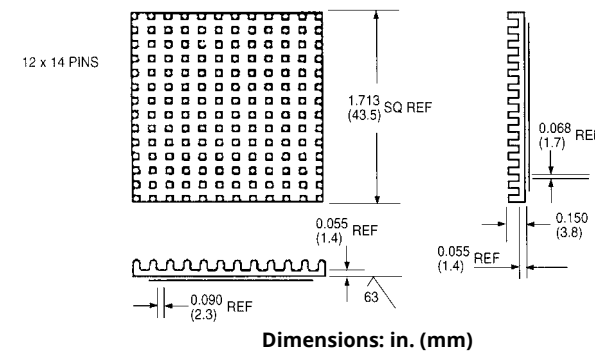

#### NATURAL AND FORCED CONVECTION CHARACTERISTICS

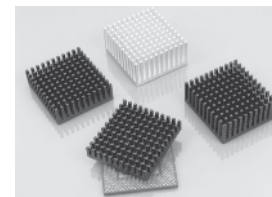
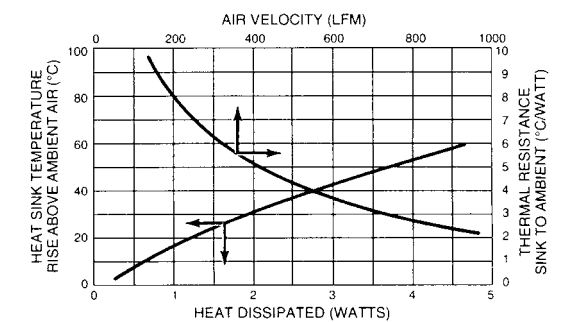

### 628 SERIES

OMNIDIRECTIONAL PIN FIN HEAT SINK FOR BGAs

Standard P/N	Base Dimensions in. (mm)	Dimensions "A" in. (mm)	Typical Applications	Heat Sink Finish	Weight lbs. (grams)
628-20AB	1.750 (44.5) x 1.700 (43.2)	0.200 (5.1)	45mm BGA	Black Anodized	0.031 (14.17)
628-25AB	1.750 (44.5) x 1.700 (43.2)	0.250 (6.4)	45mm BGA	Black Anodized	0.038 (17.01)
628-35AB	1.750 (44.5) x 1.700 (43.2)	0.350 (8.9)	45mm BGA	Black Anodized	0.044 (19.84)
628-40AB	1.750 (44.5) x 1.700 (43.2)	0.400 (10.2)	45mm BGA	Black Anodized	0.050 (22.68)
628-65AB	1.750 (44.5) x 1.700 (43.2)	0.650 (16.5)	45mm BGA	Black Anodized	0.056 (25.51)

Notes: 1. Optional factory pre-applied pressure-sensitive adhesive. See Page 8.

#### MECHANICAL DIMENSIONS

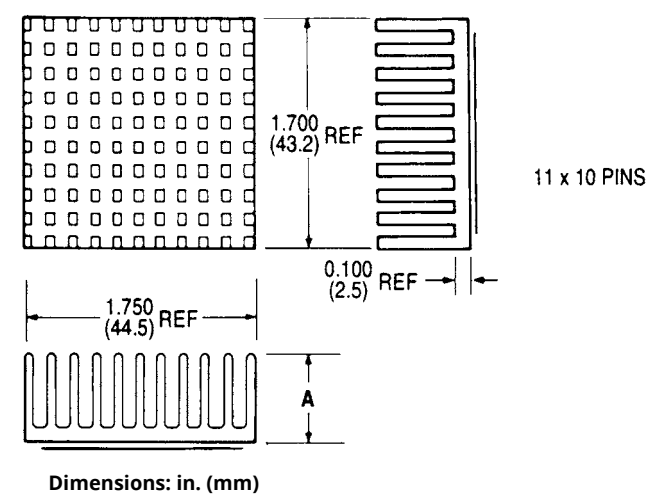

#### NATURAL CONVECTION CHARACTERISTICS

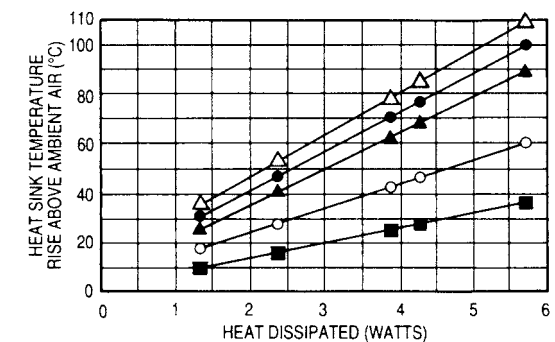

#### FORCED CONVECTION CHARACTERISTICS

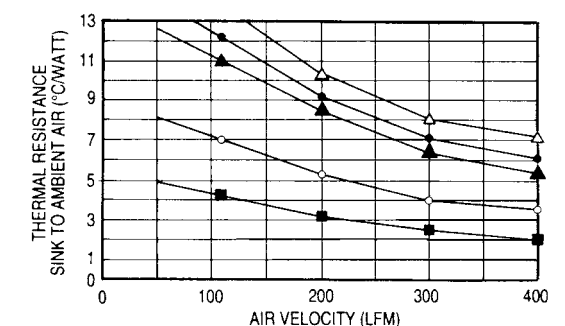

KEY:  
 △ 628-20AB  
 ● 628-25AB  
 ▲ 628-35AB  
 ○ 628-40AB  
 ■ 628-65AB



# HEAT SINKS FOR BGAs, SUPER BGAs, PBGAs, & FPBGAs

## 630 SERIES OMNIDIRECTIONAL PIN FIN HEAT SINK FOR BGAs

The **630 Series** is an omnidirectional pin fin heat sink for both natural and forced-convection applications. Applications include network routers and switches, high-resolution printers, digital cameras, consumer video games, digital video disks (DVD) and global positioning systems (GPS).

### PRODUCT FEATURES

- Available in four standard heights, .25 inch, .35 inch, .45 inch, and .60 inch.
- Available with pressure sensitive adhesives for quick and easy mounting. See Page 8.

Standard P/N	Base Dimensions in. Sq.	Fin Height "A" in. (mm)	Typical Applications	Weight lbs. (grams)
630-25AB	1.378 (35)	.250 (6.4)	35mm BGA	.009 (4.09)
630-35AB	1.378 (35)	.350 (8.9)	35mm BGA	.011 (4.99)
630-45AB	1.378 (35)	.450 (11.4)	35mm BGA	.015 (6.81)
630-60AB	1.378 (35)	.600 (15.2)	35mm BGA	.026 (11.80)

**Material:** Aluminum, Black Anodized

### MECHANICAL DIMENSIONS

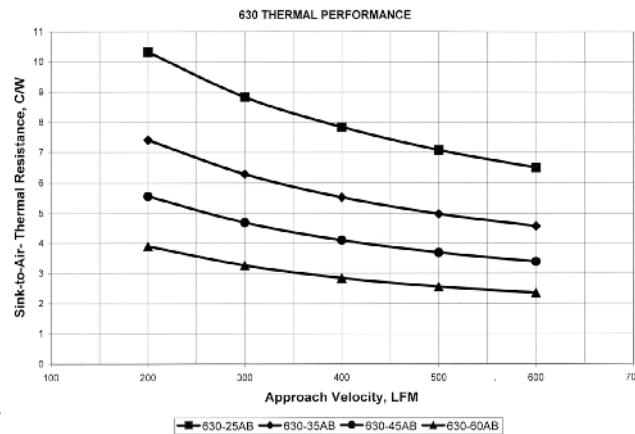
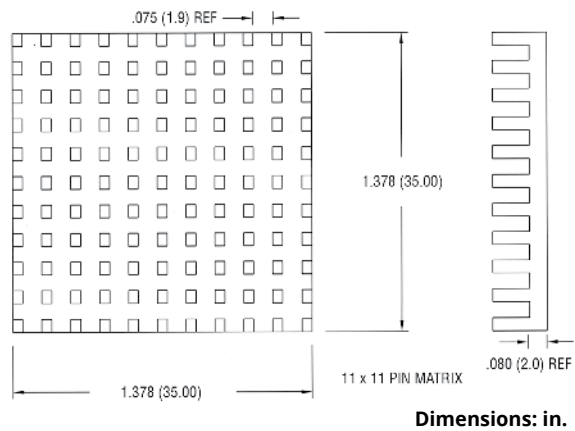

## OMNIDIRECTIONAL PIN FIN HEAT SINK FOR BGAs 698 SERIES

Standard P/N	Base Dimensions in. (mm)	Dimensions "A" in. (mm)	Typical Applications	Heat Sink Finish	Weight lbs. (grams)
698-40AB	2.100 (53.3) sq.	0.400 (10.2) sq.	45mm BGA	Black Anodized	0.075 (34.02)
698-65AB	2.100 (53.3) sq.	0.650 (16.5) sq.	45mm BGA	Black Anodized	0.119 (53.86)
698-80AB	2.100 (53.3) sq.	0.800 (20.3) sq.	45mm BGA	Black Anodized	0.125 (56.70)
698-100AB	2.100 (53.3) sq.	1.000 (25.4) sq.	45mm BGA	Black Anodized	0.144 (65.20)

**Notes:** 1. Optional factory preapplied pressure-sensitive adhesive. See Page 8.

### MECHANICAL DIMENSIONS

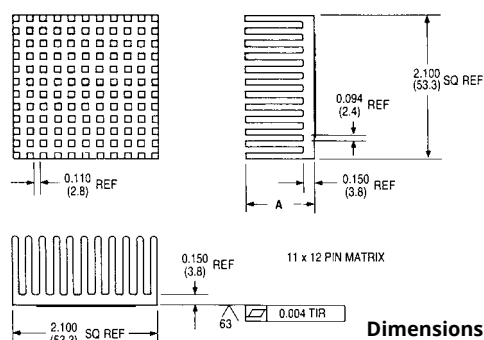

### FORCED CONVECTION THERMAL PERFORMANCE DATA (FLOW PARALLEL TO EXTRUSION DIRECTION)

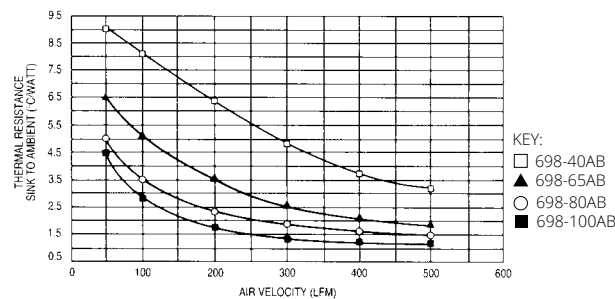

## PIN FIN HEAT SINK FOR BGAs 798 SERIES

Standard P/N	Base Dimensions in. (mm)	Dimensions "A" in. (mm)	Typical Applications	Heat Sink Finish	Weight lbs. (grams)
798-40AB	2.100 (53.3) x 1.860 (47.2)	0.400 (10.2)	45mm BGA	Black Anodized	0.063 (28.35)
798-65AB	2.100 (53.3) x 1.860 (47.2)	0.650 (16.5)	45mm BGA	Black Anodized	0.106 (48.19)
798-80AB	2.100 (53.3) x 1.860 (47.2)	0.800 (20.3)	45mm BGA	Black Anodized	0.113 (51.03)
798-100AB	2.100 (53.3) x 1.860 (47.2)	1.000 (25.4)	45mm BGA	Black Anodized	0.131 (59.53)

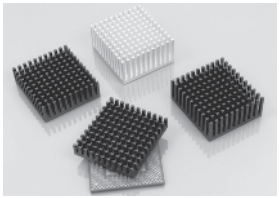

### MECHANICAL DIMENSIONS

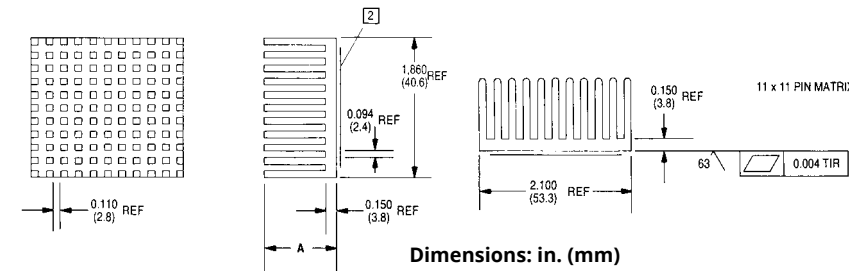

### FORCED CONVECTION THERMAL PERFORMANCE DATA (FLOW PARALLEL TO EXTRUSION DIRECTION)

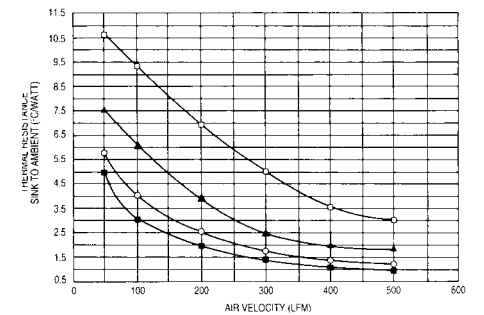

### NOTES:

1. Heat sink mounting surface flatness: 0.004" TIR
2. Optional factory pre-applied pressure-sensitive adhesive. See Page 8.

KEY: □ 798-40AB ▲ 798-65AB ○ 798-80AB ■ 798-100AB

## 643 SERIES OMNIDIRECTIONAL PIN FIN HEAT SINK FOR BGAs

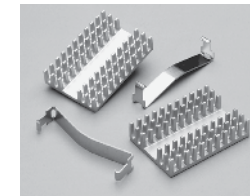

The **Series 643-35AP** is an omnidirectional pin fin heat sink for both natural and forced-convection applications designed to fit a 40 mm BGA. Applications include network routers and switches, high-resolution printers, digital cameras, consumer video games, digital video disks (DVD) and global positioning systems (GPS).

### PRODUCT FEATURES

- Available with pressure sensitive adhesives to ensure good thermal performance. See page 8.
- Can be ordered with the **829SC clip**. Order clip separately. (Clip cannot be purchased without heat sink)

Standard P/N	Base Dimensions in. (mm)	Fin Height in. (mm)	Typical Applications	Weight lbs. (grams)
643-35AP	1.60 (40.64) x 1.10 (27.94)	0.350 (8.89)	40 mm BGA	.070 (31.78)

**Material:** Aluminum, Plain Finish

### MECHANICAL DIMENSIONS

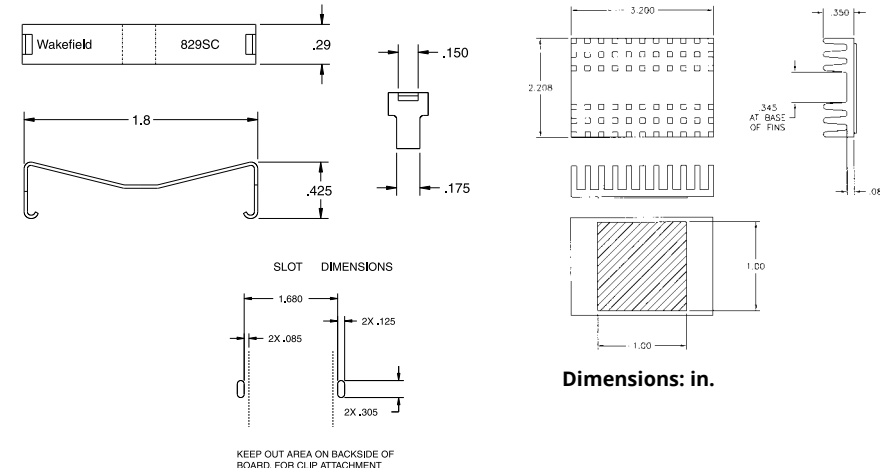

### 643 THERMAL PERFORMANCE

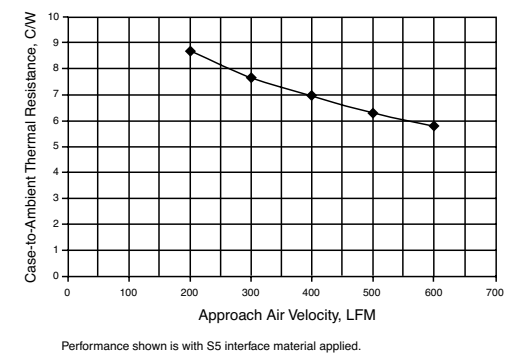



## DELTEM™ COMPOSITE HEAT SINKS FOR BGAs

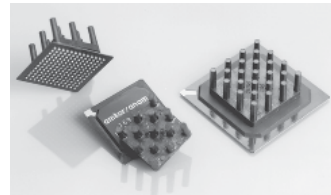

### DELTEM™ D10650-40 PIN FIN HEAT SINK

Standard P/N	Base Dimensions in. (mm)	Height in. (mm)	Weight lbs. (grams)
D10650-40	0.650 (16.5) sq	0.400 (10.2)	0.004 (1.91)

**Notes:** Available with pressure sensitive adhesives for quick and easy mounting. See Page 8.

### PIN FIN HEAT SINK DELTEM™ D10850-40

Standard P/N	Base Dimensions in. (mm)	Height in. (mm)	Typical Applications	Weight lbs. (grams)
D10850-40	0.850 (21.6) sq	0.400 (10.2)	21mm BGA	0.006 (3.9)

**Notes:** Available with pressure sensitive adhesives for quick and easy mounting. See Page 8.

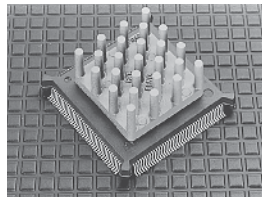

#### MECHANICAL DIMENSIONS

##### DELTEM™ D10650-40 PIN FIN HEAT SINK

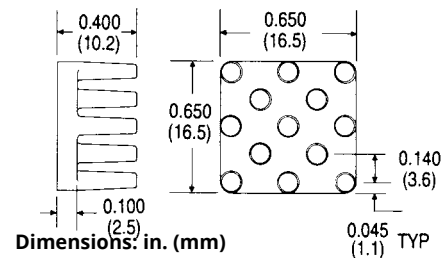

#### NATURAL AND FORCED CONVECTION CHARACTERISTICS

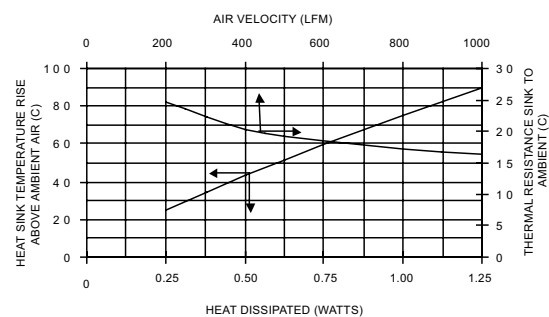

##### DELTEM™ D10850-40 PIN FIN HEAT SINK

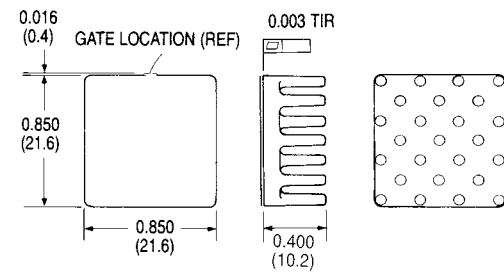

#### NATURAL AND FORCED CONVECTION CHARACTERISTICS

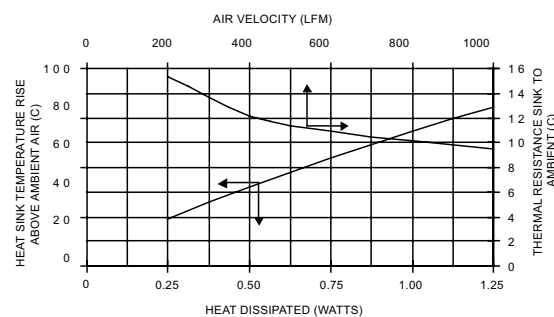

## HEAT SINKS FOR BGAs, SUPER BGAs, PBGAs, & FPBGAs

### PIN FIN HEAT SINK FOR BGAs HEAT SINK/CLIP ASSEMBLY FOR BGAs AND POWERPC™ PACKAGES

### 609 SERIES

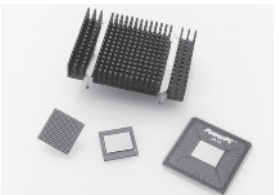

Standard P/N	Base Dimensions in. (mm)	Dimensions "A" in. (mm)	Typical Applications	Heat Sink Finish	Weight lbs. (grams)
609-50AB	2.895 (73.5) x 2.000 (50.8)	0.500 (12.7)	40&45mm BGA	Black Anodized	0.094 (42.5)
609-100AB	2.808 (71.32) x 1.700 (43.2)	1.00 (25.4)	40&45mm BGA	Black Anodized	0.130 (59.0)

**Note:** Optional factory pre-applied thermal interface material.  
S3 (Bergquist Q-Pad 3, 0.14 °C in<sup>2</sup>/w)  
S4 (Bergquist Softface, 0.07 °C in<sup>2</sup>/w)

#### MECHANICAL DIMENSIONS

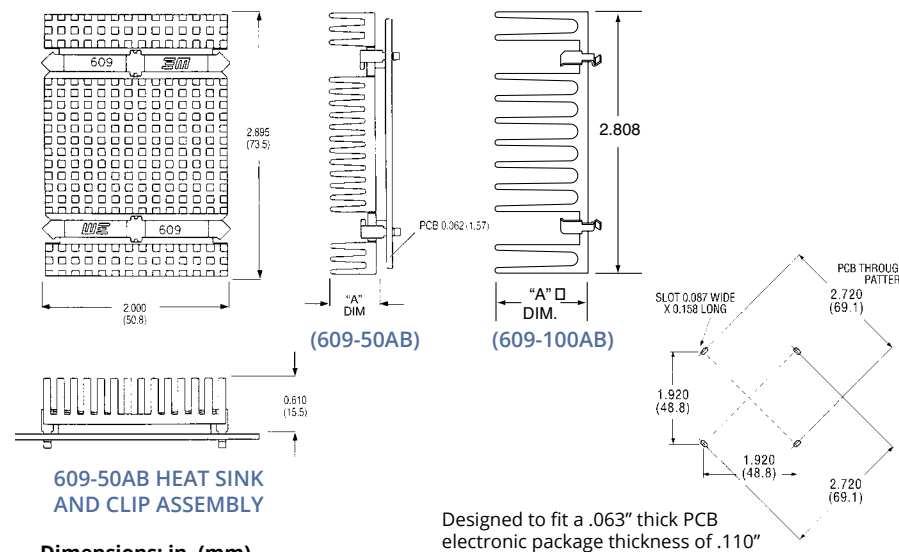

#### FORCED CONVECTION THERMAL PERFORMANCE DATA (LOW PARALLEL TO EXTRUSION DIRECTION)

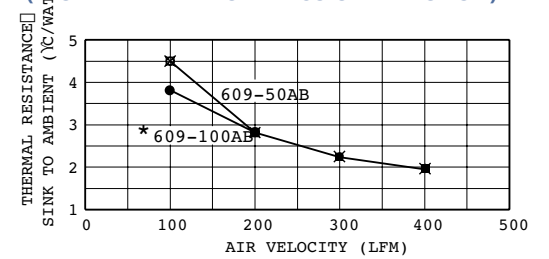

\*Performance is for shrouded conditions. 609-100 will perform better than 609-50 in cases with bypass.

#### 609-50AB HEAT SINK AND CLIP ASSEMBLY

Dimensions: in. (mm)

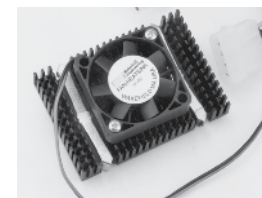

### 619 SERIES FAN HEAT SINK FOR BGA AND POWERPC™ PACKAGES

Standard P/N	Base Dimensions in. (mm)	Height in. (mm)	Typical Applications	Heat Sink Finish	Thermal Performance	Weight lbs.(grams)
61995AB124D1	2.871 (72.92) x 1.98 (50.29)	0.953 (24.21)	40&45mm BGA	Black Anodized	1.2° C/W	.150 (68.10)
61995AB054D1	2.871 (72.92) x 1.98 (50.29)	0.953 (24.21)	40&45mm BGA	Black Anodized	1.2° C/W	.150 (68.10)

**Note:** Optional factory pre-applied thermal interface material. See 609 series.

#### FEATURES AND BENEFITS

- Captivated clips for ease of assembly.
- Low acoustic noise.
- Impingement air flow.
- Accommodates BGA packages up to 45 mm in size.

#### MECHANICAL DIMENSIONS

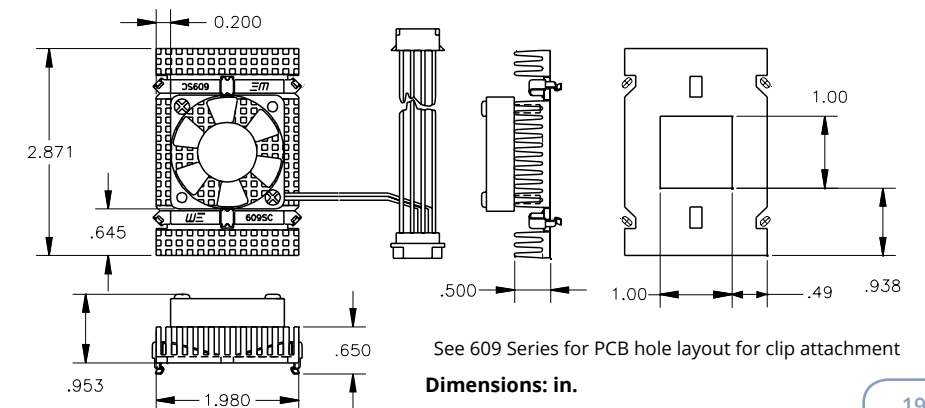

## HEAT SINKS FOR BGAs, SUPER BGAs, PBGAs, & FPBGAs

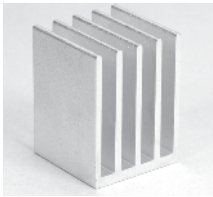

### 602 SERIES

UNIDIRECTIONAL FIN HEAT SINK FOR BGAs

Standard P/N	Base Dimensions in. (mm)	Height in. (mm)	Heat Sink Finish	Weight lbs. (grams)
602-100AP	.750 (19.1) sq	1.000 (25.4)	Plain	.021 (9.59)
<b>Material:</b> Aluminum, Plain Finish				

#### MECHANICAL DIMENSIONS

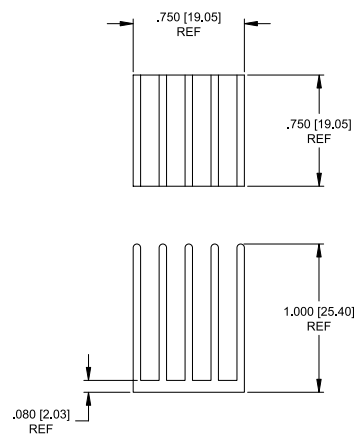

#### 602 THERMAL PERFORMANCE

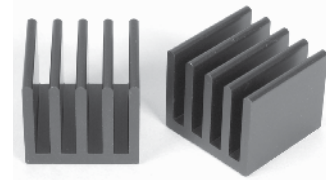
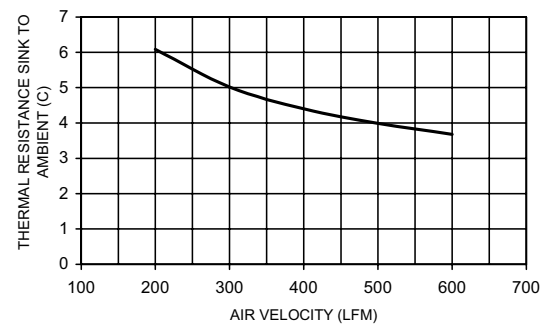

UNIDIRECTIONAL FIN HEAT SINK FOR BGAs

### 605 SERIES

Standard P/N	Base Dimensions in. (mm)	Height in. (mm)	Heat Sink Finish	Weight lbs. (grams)
605-75AB	.880 (22.4) sq	.750 (19.1)	Black Anodized	.030 (13.5)
<b>Material:</b> Aluminum, Black Anodized				

#### MECHANICAL DIMENSIONS

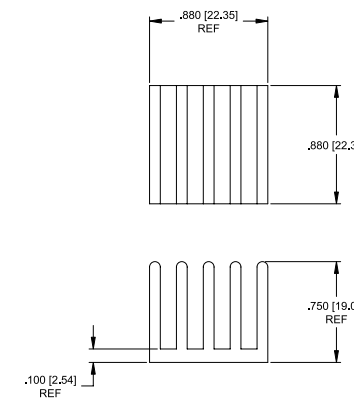

#### 605 THERMAL PERFORMANCE

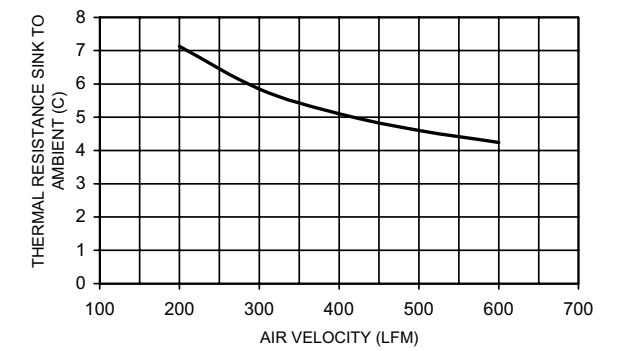

OMNIDIRECTIONAL PIN FIN HEAT SINK FOR BGAs

### 604 SERIES

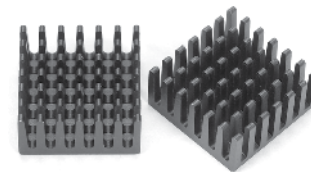

Standard P/N	Base Dimensions in. (mm)	Height in. (mm)	Heat Sink Finish	Weight lbs. (grams)
604-40AB	.850 (21.6) sq	.400 (10.2)	Black Anodized	.012 (5.60)
604-60AB	.850 (21.6) sq	.600 (15.2)	Black Anodized	.016 (7.47)
<b>Material:</b> Aluminum, Black Anodized				

#### MECHANICAL DIMENSIONS

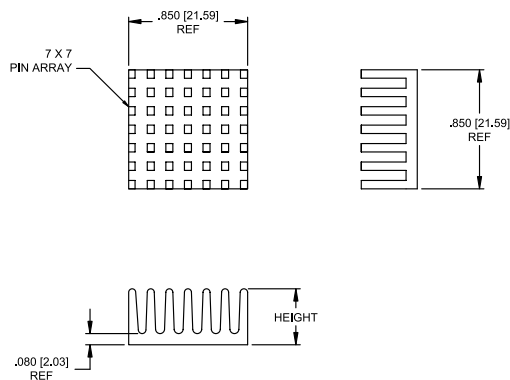

#### 604 THERMAL PERFORMANCE

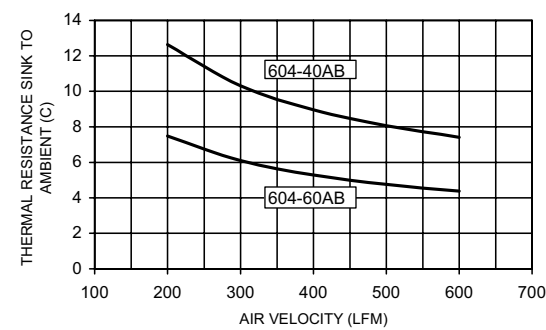

### 606 SERIES

UNIDIRECTIONAL FIN HEAT SINK FOR BGAs

Standard P/N	Base Dimensions in. (mm)	Height in. (mm)	Heat Sink Finish	Weight lbs. (grams)
606-77AB	1.185 (30.1) sq	.767 (19.5)	Black Anodized	.041 (18.7)
<b>Material:</b> Aluminum, Black Anodized				

#### MECHANICAL DIMENSIONS

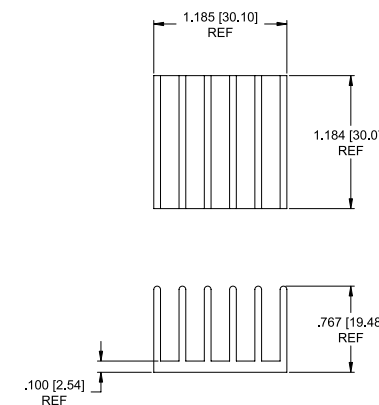

#### 606 THERMAL PERFORMANCE

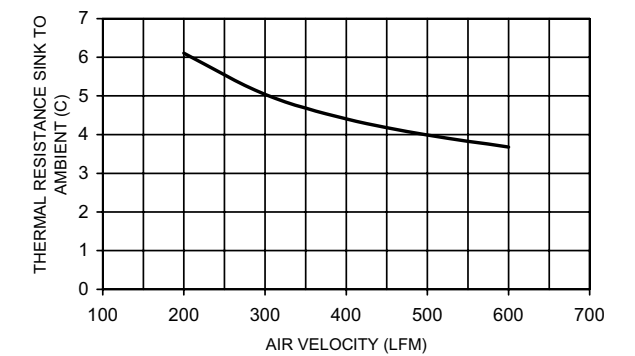

## HEAT SINKS FOR BGAs, SUPER BGAs, PBGAs, & FPBGAs

### 607 SERIES

UNIDIRECTIONAL FIN HEAT SINK FOR BGAs

Standard P/N	Base Dimensions in. (mm)	Height in. (mm)	Heat Sink Finish	Weight lbs. (grams)
607-65AB	1.200 (30.5) x 1.105 (28.1)	.650 (16.5)	Black Anodized	.041 (18.7)
<b>Material:</b> Aluminum, Black Anodized				

#### MECHANICAL DIMENSIONS

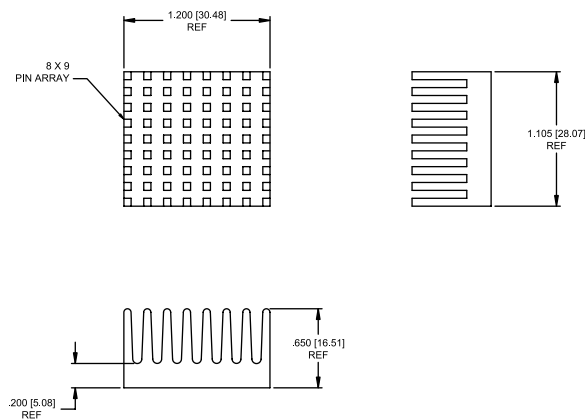

#### 607 THERMAL PERFORMANCE

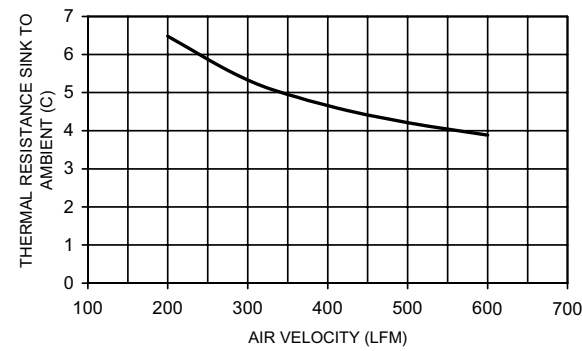

### OMNIDIRECTIONAL PIN FIN HEAT SINK FOR BGAs

### 610 SERIES

Standard P/N	Base Dimensions in. (mm)	Height in. (mm)	Heat Sink Finish	Weight lbs. (grams)
610-35AB	1.240 (31.5) sq	.350 (8.9)	Black Anodized	.022 (10.0)
610-40AB	1.240 (31.5) sq	.400 (10.2)	Black Anodized	.024 (10.8)
<b>Material:</b> Aluminum, Black Anodized				

#### MECHANICAL DIMENSIONS

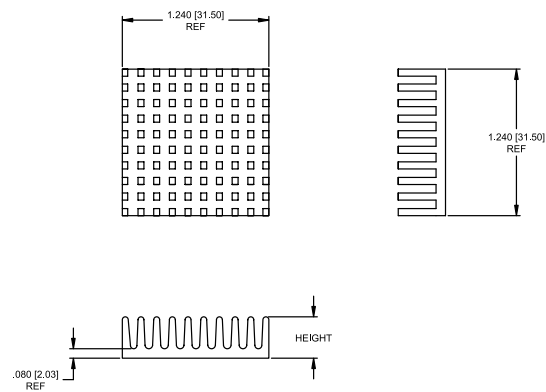

#### 610 THERMAL PERFORMANCE

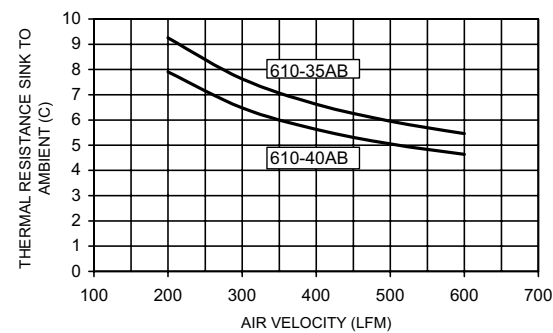

### UNIDIRECTIONAL FIN HEAT SINK FOR BGAs

### 611 SERIES

Standard P/N	Base Dimensions in. (mm)	Height in. (mm)	Heat Sink Finish	Weight lbs. (grams)
611-80AB	1.200 (30.5) sq	.800 (20.3)	Black Anodized	.036 (16.3)
<b>Material:</b> Aluminum, Black Anodized				

#### MECHANICAL DIMENSIONS

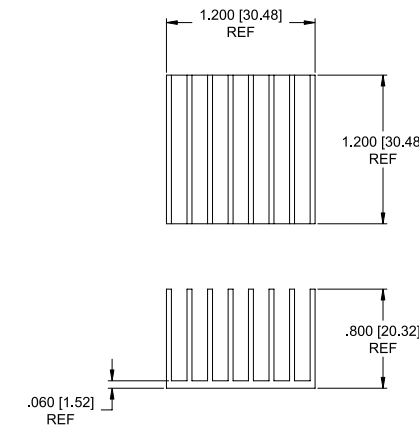

#### 611 THERMAL PERFORMANCE

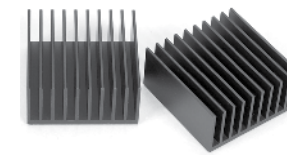
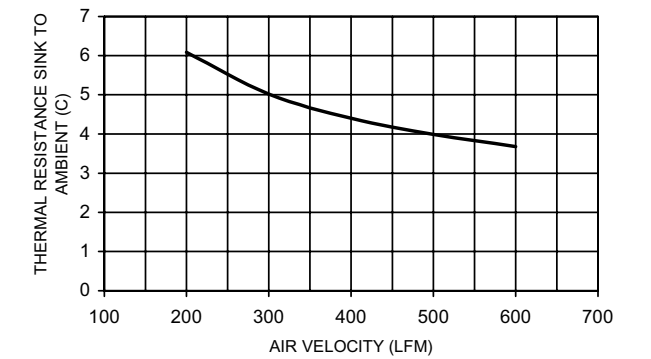

### 612 SERIES

UNIDIRECTIONAL FIN HEAT SINK FOR BGAs

Standard P/N	Base Dimensions in. (mm)	Height in. (mm)	Heat Sink Finish	Weight lbs. (grams)
612-65AB	1.390 (35.3) sq	.650 (16.5)	Black Anodized	.054 (24.5)
<b>Material:</b> Aluminum, Black Anodized				

#### MECHANICAL DIMENSIONS

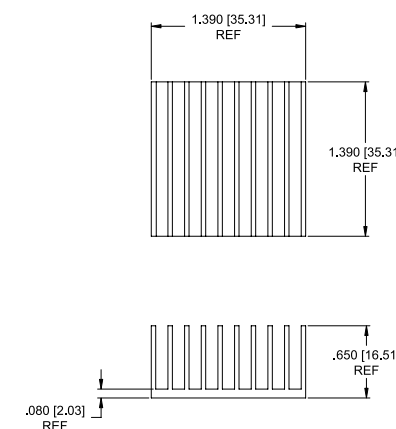

#### 612 THERMAL PERFORMANCE

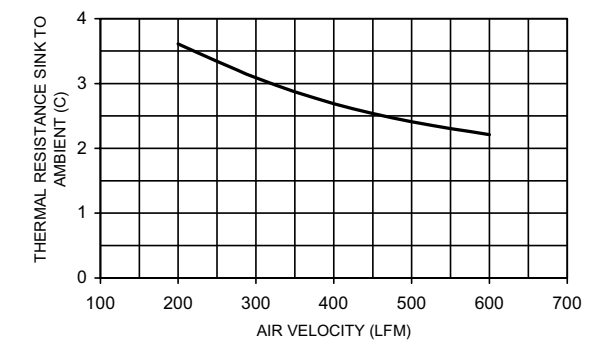

## HEAT SINKS FOR BGAs, SUPER BGAs, PBGAs, & FPBGAs

### 613 SERIES

UNIDIRECTIONAL FIN HEAT SINK FOR BGAs

Standard P/N	Base Dimensions in. (mm)	Height in. (mm)	Heat Sink Finish	Weight lbs. (grams)
613-50AB	1.450 (36.8) sq	.500 (12.7)	Black Anodized	.046 (20.8)

**Material:** Aluminum, Black Anodized

#### MECHANICAL DIMENSIONS

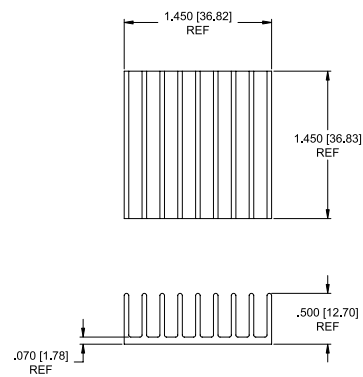

#### 613 THERMAL PERFORMANCE

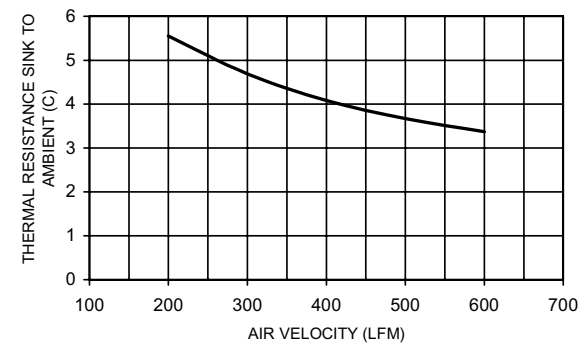

UNIDIRECTIONAL FIN HEAT SINK FOR BGAs

### 614 SERIES

Standard P/N	Base Dimensions in. (mm)	Height in. (mm)	Heat Sink Finish	Weight lbs. (grams)
614-30AB	1.500 (38.1) sq	.300 (7.6)	Black Anodized	.030 (13.8)
614-50AB	1.500 (38.1) sq	.500 (12.7)	Black Anodized	.048 (21.8)
614-100AP	1.500 (38.1) sq	1.000 (25.4)	Plain	.046 (20.9)

**Material:** Aluminum, Black Anodized or Plain

#### MECHANICAL DIMENSIONS

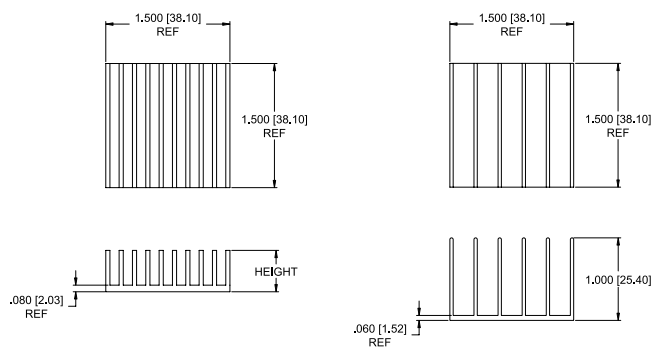

#### 614 THERMAL PERFORMANCE

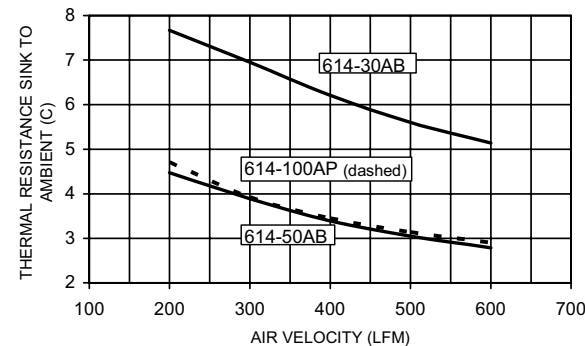

UNIDIRECTIONAL FIN HEAT SINK FOR BGAs

### 615 SERIES

Standard P/N	Base Dimensions in. (mm)	Height in. (mm)	Heat Sink Finish	Weight lbs. (grams)
615-41AB	1.600 (40.6) sq	.410 (10.4)	Black Anodized	.046 (21.0)

**Material:** Aluminum, Black Anodized

#### MECHANICAL DIMENSIONS

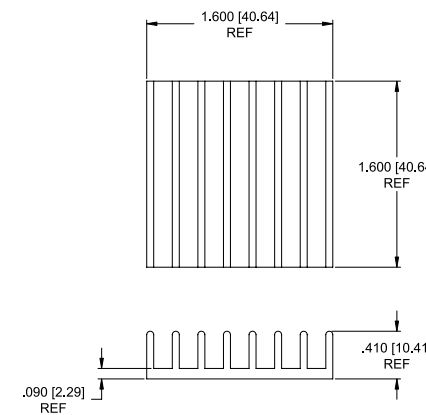

#### 615 THERMAL PERFORMANCE

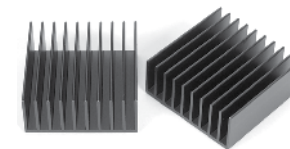
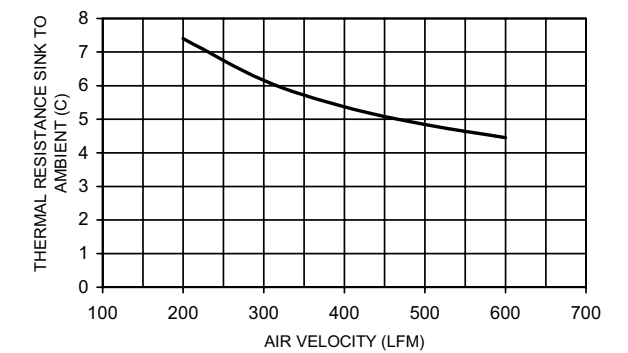

### 616 SERIES

UNIDIRECTIONAL FIN HEAT SINK FOR BGAs

Standard P/N	Base Dimensions in. (mm)	Height in. (mm)	Heat Sink Finish	Weight lbs. (grams)
616-80AB	1.85 (47.0) sq	.800 (20.3)	Black Anodized	.054 (24.5)

**Material:** Aluminum, Black Anodized

#### MECHANICAL DIMENSIONS

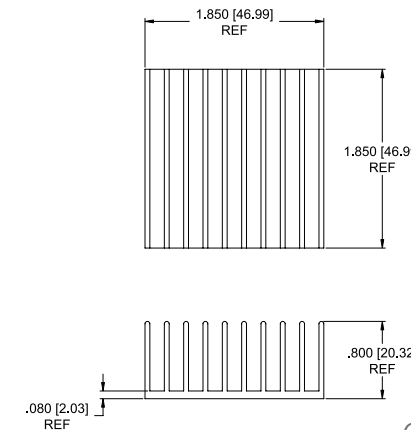

#### 616 THERMAL PERFORMANCE

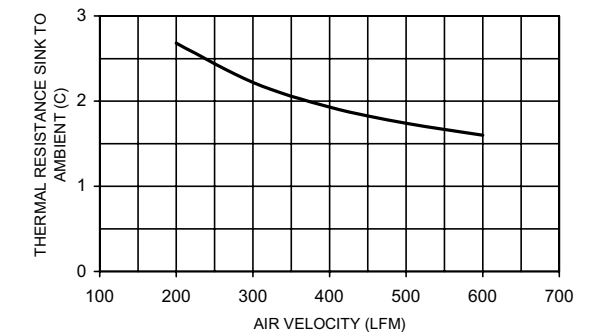



## HEAT SINKS FOR BGAs, SUPER BGAs, PBGAs, & FPBGAs

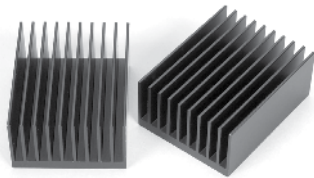

### 617 SERIES

UNIDIRECTIONAL FIN HEAT SINK FOR BGAs

Standard P/N	Base Dimensions in. (mm)	Height in. (mm)	Heat Sink Finish	Weight lbs. (grams)
617-80AB	1.450 (36.8) x 1.850 (47.0)	.800 (20.3)	Black Anodized	.082 (37.2)
<b>Material:</b> Aluminum, Black Anodized				

#### MECHANICAL DIMENSIONS

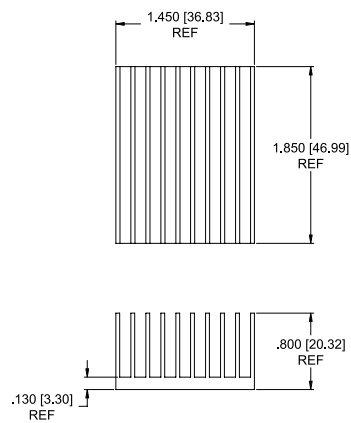

#### 617 THERMAL PERFORMANCE

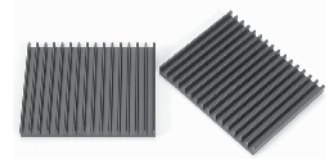
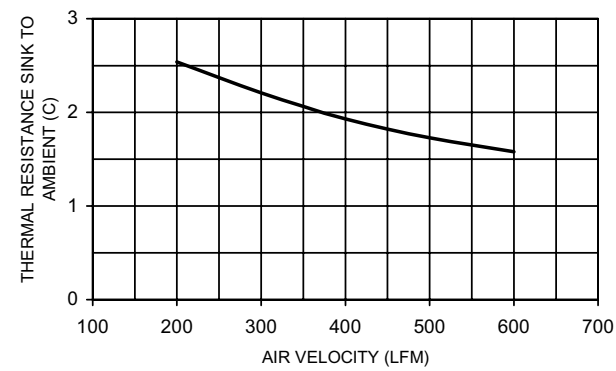

UNIDIRECTIONAL FIN HEAT SINK FOR BGAs

### 620 SERIES

Standard P/N	Base Dimensions in. (mm)	Height in. (mm)	Heat Sink Finish	Weight lbs. (grams)
620-24AB	2.500 (63.5) x 2.000 (50.8)	.235 (6.0)	Black Anodized	.063 (28.6)
<b>Material:</b> Aluminum, Black Anodized				

#### MECHANICAL DIMENSIONS

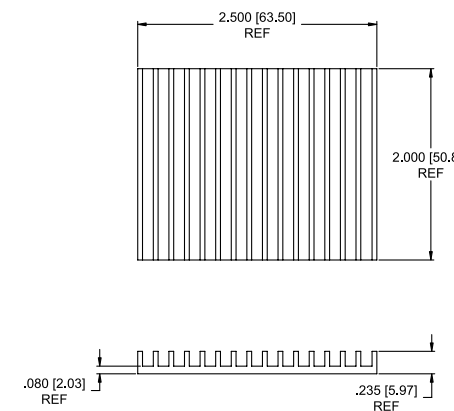

#### 620 THERMAL PERFORMANCE

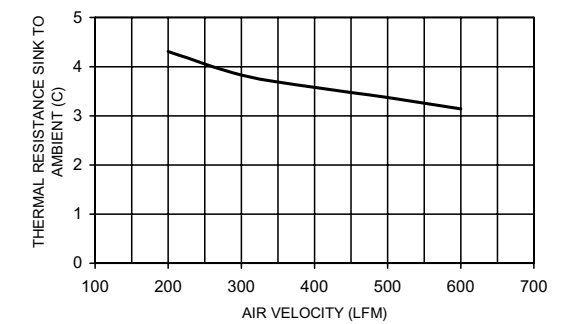

UNIDIRECTIONAL FIN HEAT SINK FOR BGAs

### 618 SERIES

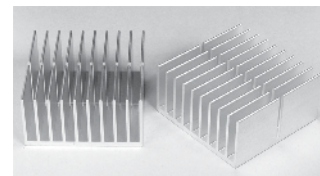

Standard P/N	Base Dimensions in. (mm)	Height in. (mm)	Heat Sink Finish	Weight lbs. (grams)
618-20AB	2.00 (50.8) sq	.200 (5.1)	Black Anodized	.046 (21.0)
618-100AP	2.00 (80.8) sq	1.000 (25.4)	Plain	.122 (55.5)
<b>Material:</b> Aluminum, Black Anodized or Plain				

#### MECHANICAL DIMENSIONS

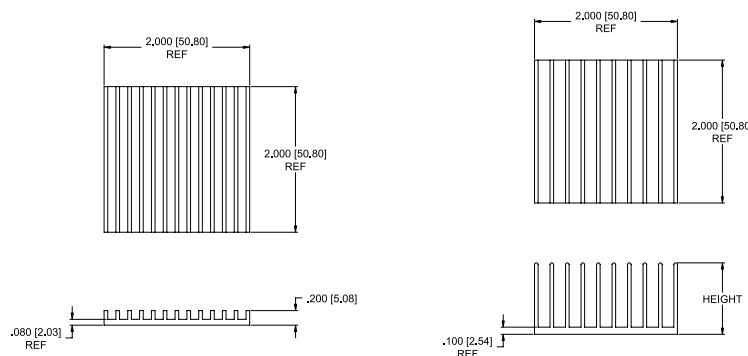

#### 618 THERMAL PERFORMANCE

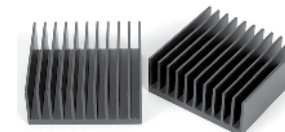
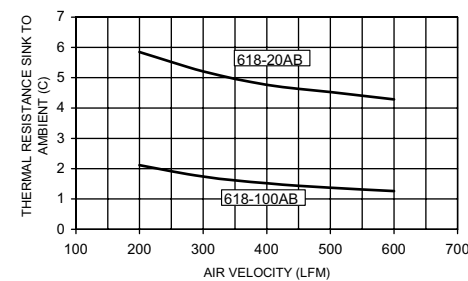

### 622 SERIES

UNIDIRECTIONAL FIN HEAT SINK FOR BGAs

Standard P/N	Base Dimensions in. (mm)	Height in. (mm)	Heat Sink Finish	Weight lbs. (grams)
622-80AB	2.050 (52.1) x 2.000 (50.8)	.800 (20.3)	Black Anodized	.123 (56.0)
<b>Material:</b> Aluminum, Black Anodized				

#### MECHANICAL DIMENSIONS

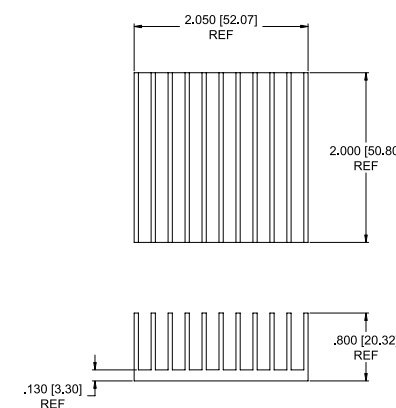

#### 622 THERMAL PERFORMANCE

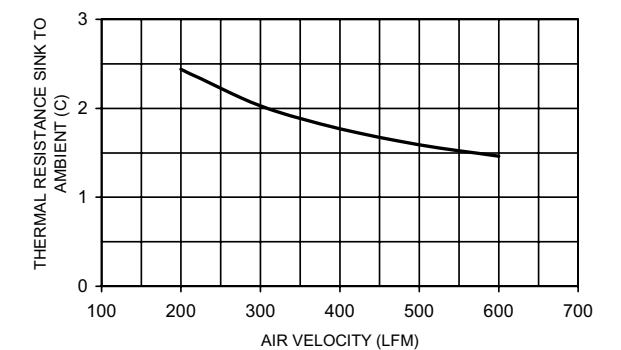

## HEAT SINKS FOR MICROPROCESSORS & ASICs

### 569, 579, 589, 599 SERIES

HEAT SINKS & CLIP FOR INTEL'S PENTIUM, PENTIUM MMX, AMD'S K6 & K62,  
CYRIX'S 6X86 & MEDIA GX, CENTAUR/IDT'S WINCHIP C6

#### PRODUCT FEATURES

- Compact design heat sinks can comfortably fit a variety of Robust Socket 7-based PC boxes.
- Robust clip attachments.
- Clips are not captive to sink.
- To order heat sink with optional interface material pre-applied at the factory, add S4 or S5 suffix to the part number. (See Product Designation)

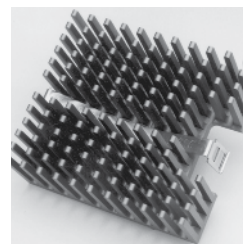

569-100AK SERIES

Standard P/N	Base Dimensions in. (mm)	Fin Height in. (mm)	Thermal Resistance at 200 LFM (°C/W)	Interface Material Options
569-100AK	2.34 (59.44) x 2.68 (67.95)	1.00 (25.4)	1.7	Pages 74-76
579-150AK	2.15 (54.71) x 1.95 (49.53)	1.50 (38.10)	1.6	Pages 74-76
589-150AK	2.15 (54.71) x 3.10 (78.74)	1.50 (38.10)	1.5	Pages 74-76
599X-100AB	1.96 (49.78) x 2.67 (67.95)	1.00 (25.4)	1.9	Pages 74-76

**Material:** Aluminum, Black Anodized

#### MECHANICAL DIMENSIONS

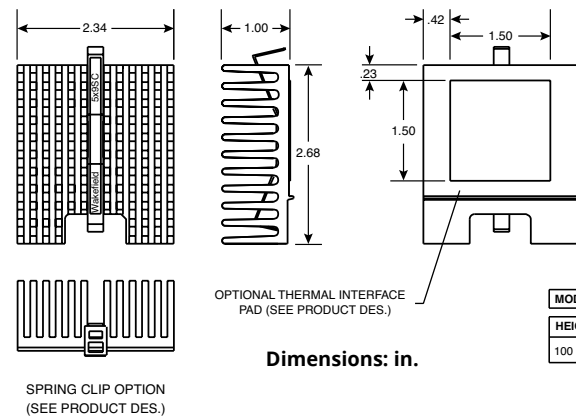

#### PRODUCT DESIGNATION

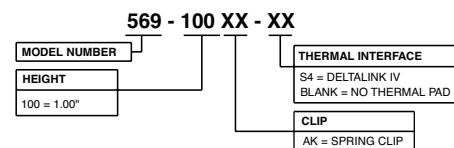

### LOW-COST HEAT SINKS FOR DIPs AND SRAMs

### 650 & 651 SERIES

14-16 Pin DIPs

These extruded heat sinks serve as low-cost heat dissipation solutions for DIPs with pin counts from 14 to 16. Use an epoxy such as Wakefield-Vette Engineering DeltaBond™ 152 or 155, or use Wakefield-Vette 2-part DeltaBond™ 156 modified acrylic adhesive. The 650 and 651 are also available in natural aluminum finish. They can be ordered as 650P or 651P.

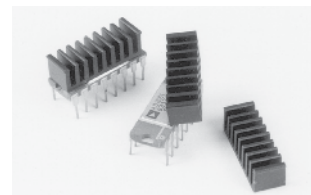

Standard P/N	Length in. (mm)	Width in. (mm)	Height in. (mm)	Typical Applications	Weight lbs. (grams)
650B	0.250 (6.4)	0.740 (18.9)	0.240 (6.1)	14-Pin, 16-Pin DIP	0.003 (1.36)
651B	0.750 (19.1)	0.415 (10.5)	0.240 (6.1)	14-Pin, 16-Pin DIP	0.005 (2.27)

#### MECHANICAL DIMENSIONS

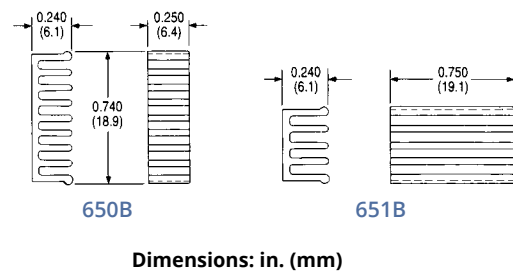

#### NATURAL AND FORCED CONVECTION CHARACTERISTICS

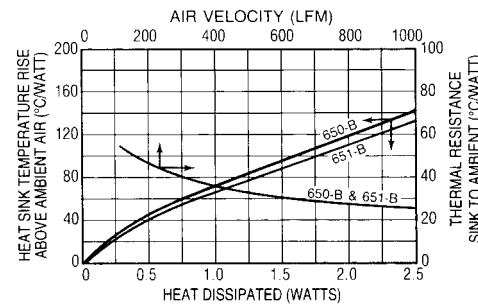

#### NOTES:

1. Finish: black anodize
2. TIR: Total Indicator Reading. This is a measure of flatness across the greatest dimension of a surface.

### SPIDERCLIP™ HEAT SINK ASSEMBLY FOR MOTOROLA MC68040™, MC68060

### 649 SERIES

18 x 18 PGA

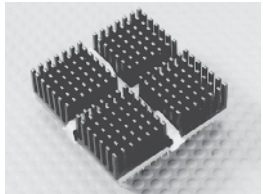

Standard P/N	Base Dimensions in. (mm)	Height in. (mm)	Base Thickness in. (mm)	Clip Color	Heat Sink Finish	Weight lbs. (grams)
649-33AB	1.70 (43.2) sq	0.315 (8.0)	0.090 (2.3)	Gray	Black Anodized	0.044 (19.84)
649-51AB	1.86 (47.2) sq	0.510 (13.0)	0.090 (2.3)	Gray	Black Anodized	0.056 (25.51)

#### MECHANICAL DIMENSIONS

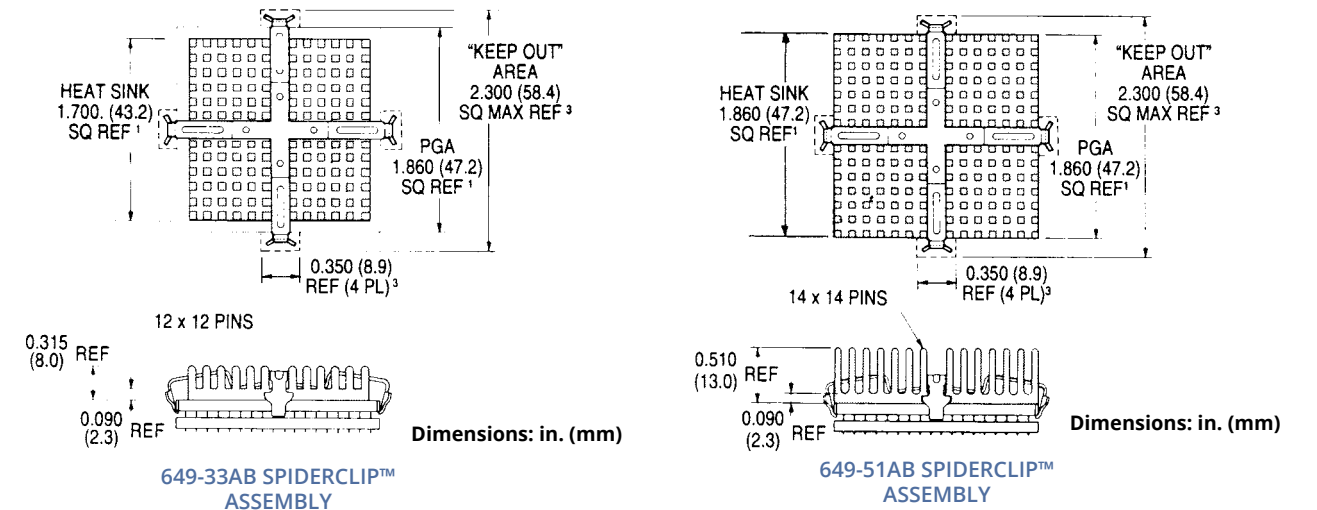

#### NATURAL AND FORCED CONVECTION CHARACTERISTICS

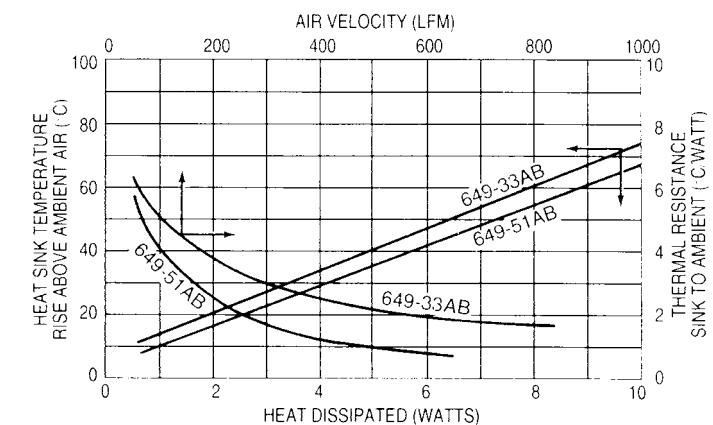

## HEAT SINKS FOR MICROPROCESSORS & ASICs

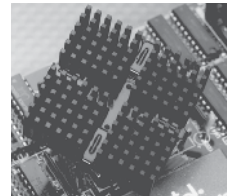

### 669 SERIES

SPIDERCLIP™ HEAT SINK ASSEMBLY FOR INTEL DX4™, AMD AM486DX2, AND AM486DX4

17 x 17 SPGA

### 661 SERIES

HEAT SINK WITHOUT CLIP

669 Series SpiderClip™ Heat Sink Assemblies may be applied to the following:

- Intel 80486DX and 80486DX2™ (168 PGA)
- Intel DX4™ (168 PGA)
- Intel 80486SX (168 PGA) and I860XR (208 PGA)
- AMD Am 486 Microprocessors AM486DX2, AM486DX4
- Intel 82495 Cache Controller
- AMD Am 29000 Microcontrollers
- Intel I960CA, I960CF Embedded Controllers

Standard P/N	Base Dimensions in. (mm)	Dimensions "A" Height in. (mm)	Base Thickness in. (mm)	Clip Color	Standard Finish	Weight lbs. (grams)
669-32AG	1.70 (43.2) sq	0.315 (8.0)	0.090 (2.3)	Black	Gold Iridite	0.044 (19.84)
669-33AB	1.70 (43.2) sq	0.315 (8.0)	0.090 (2.3)	Black	Black Anodized	0.044 (19.84)
669-40AB	1.70 (43.2) sq	0.400 (10.2)	0.090 (2.3)	Black	Black Anodized	0.044 (19.84)
669-52AB	1.70 (43.2) sq	0.520 (13.2)	0.090 (2.3)	Black	Black Anodized	0.050 (22.68)
661-32AG	1.70 (43.2) sq	0.315 (8.0)	0.090 (2.3)	N/A	Gold Iridite	0.044 (19.84)
661-33AB	1.70 (43.2) sq	0.315 (8.0)	0.090 (2.3)	N/A	Black Anodized	0.044 (19.84)
661-40AB	1.70 (43.2) sq	0.400 (10.2)	0.090 (2.3)	N/A	Black Anodized	0.044 (19.84)
661-52AB	1.70 (43.2) sq	0.520 (13.2)	0.090 (2.3)	N/A	Black Anodized	0.050 (22.68)

### MECHANICAL DIMENSIONS

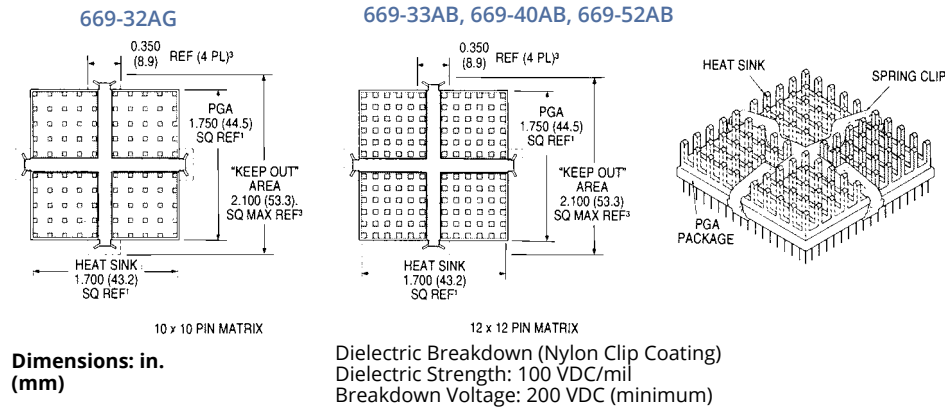

Dimensions: in. (mm)  
Dielectric Breakdown (Nylon Clip Coating)  
Dielectric Strength: 100 VDC/mil  
Breakdown Voltage: 200 VDC (minimum)

### NATURAL AND FORCED CONVECTION CHARACTERISTICS

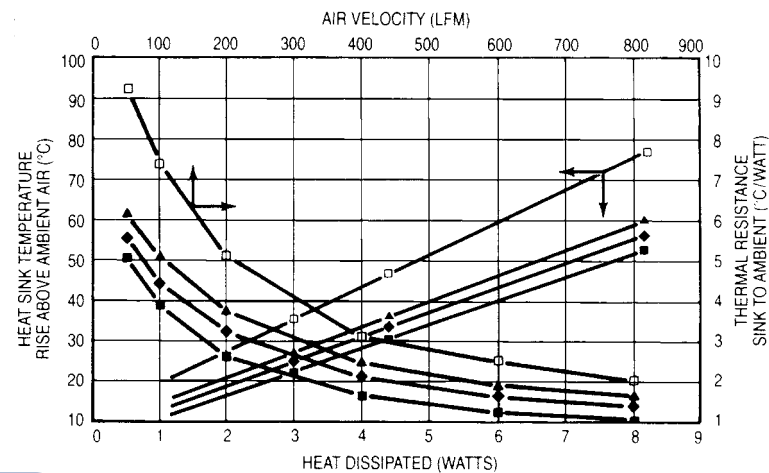

KEY:  
 □ 669-32AG 0.315 (8.0) Pin Height, low density pin pattern  
 ▲ 669-33AB 0.315 (8.0) Pin Height, high density pin pattern  
 ◆ 669-40AB 0.400 (10.2) Pin Height, high density pin pattern  
 ■ 669-52AB 0.520 (13.2) Pin Height, high density pin pattern

## PIN FIN HEAT SINK



### 900 SERIES

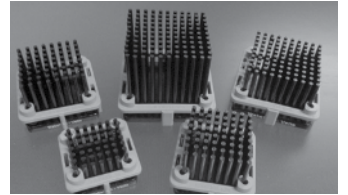

Wakefield-Vette's 900 Series Heat Sinks for Chipset can match up to devices from Intel, Xilinx, TI, Motorola, ATI, AMD, Nvidia, Vishay, Powerex, Infineon, Microsemi, and many more.

These heat sinks are designed for air flow applications in the Telecom, Data Center, Networking, Cloud Computing, and many more Industries.

Series	Height	Chip Size	Natural Convection	Forced Convection			Series	Height	Chip Size	Natural Convection	Forced Convection		
				200 LFM	400 LFM	600 LFM					200 LFM	400 LFM	600 LFM
901	12	19mm	12.74 C/W	6.6 C/W	4.79 C/W	4.16 C/W	906	12	31mm	10.71 C/W	3.49 C/W	2.28 C/W	1.69 C/W
	15	19mm	12.05 C/W	6.3 C/W	4.51 C/W	3.86 C/W		15	31mm	10.14 C/W	3.18 C/W	2.03 C/W	1.5 C/W
	18	19mm	11.35 C/W	5.97 C/W	4.16 C/W	3.47 C/W		18	31mm	9.57 C/W	2.93 C/W	1.86 C/W	1.33 C/W
	21	19mm	10.66 C/W	5.66 C/W	3.89 C/W	3.21 C/W		21	31mm	9.01 C/W	2.72 C/W	1.69 C/W	1.2 C/W
	23	19mm	10.55 C/W	5.36 C/W	3.64 C/W	2.99 C/W		23	31mm	8.88 C/W	2.5 C/W	1.54 C/W	1.07 C/W
	28	19mm	10.27 C/W	4.91 C/W	3.36 C/W	2.71 C/W		28	31mm	8.56 C/W	2.26 C/W	1.38 C/W	.96 C/W
902	33	19mm	9.99 C/W	4.52 C/W	3.07 C/W	2.49 C/W	33	31mm	8.24 C/W	2.09 C/W	1.27 C/W	.88 C/W	
	12	21mm	12.4 C/W	6.61 C/W	4.37 C/W	3.7 C/W	907	12	33mm	10.37 C/W	3.32 C/W	2.18 C/W	1.62 C/W
	15	21mm	11.73 C/W	5.84 C/W	4.09 C/W	3.42 C/W		15	33mm	9.82 C/W	3.14 C/W	1.99 C/W	1.45 C/W
	18	21mm	11.06 C/W	5.51 C/W	3.76 C/W	3.07 C/W		18	33mm	9.28 C/W	2.89 C/W	1.78 C/W	1.3 C/W
	21	21mm	10.38 C/W	5.20 C/W	3.49 C/W	2.84 C/W		21	33mm	8.73 C/W	2.67 C/W	1.60 C/W	1.13 C/W
	23	21mm	10.27 C/W	4.9 C/W	3.26 C/W	2.62 C/W		23	33mm	8.60 C/W	2.45 C/W	1.43 C/W	.99 C/W
28	21mm	9.98 C/W	4.55 C/W	2.98 C/W	2.42 C/W	28		33mm	8.27 C/W	2.24 C/W	1.28 C/W	.87 C/W	
903	33	21mm	9.7 C/W	4.18 C/W	2.73 C/W	2.21 C/W	33	33mm	7.94 C/W	2.03 C/W	1.15 C/W	.77 C/W	
	12	23mm	12.06 C/W	5.72 C/W	3.95 C/W	3.24 C/W	908	12	35mm	10.03 C/W	3.06 C/W	1.97 C/W	1.49 C/W
	15	23mm	11.41 C/W	5.39 C/W	3.67 C/W	2.99 C/W		15	35mm	9.5 C/W	2.85 C/W	1.81 C/W	1.34 C/W
	18	23mm	10.76 C/W	5.05 C/W	3.35 C/W	2.67 C/W		18	35mm	8.98 C/W	2.6 C/W	1.64 C/W	1.19 C/W
	21	23mm	10.11 C/W	4.74 C/W	3.1 C/W	2.46 C/W		21	35mm	8.46 C/W	2.4 C/W	1.5 C/W	1.07 C/W
	23	23mm	9.99 C/W	4.44 C/W	2.87 C/W	2.31 C/W		23	35mm	8.32 C/W	2.19 C/W	1.34 C/W	.97 C/W
28	23mm	9.70 C/W	4.09 C/W	2.62 C/W	2.12 C/W	28		35mm	7.99 C/W	1.97 C/W	1.19 C/W	.83 C/W	
904	33	23mm	9.41 C/W	3.83 C/W	2.43 C/W	1.96 C/W	33	35mm	7.65 C/W	1.82 C/W	1.06 C/W	.7 C/W	
	12	27mm	11.38 C/W	4.84 C/W	3.11 C/W	2.32 C/W	909	12	37.5mm	9.60 C/W	2.93 C/W	1.90 C/W	1.36 C/W
	15	27mm	10.78 C/W	4.48 C/W	2.84 C/W	2.12 C/W		15	37.5mm	9.11 C/W	2.71 C/W	1.72 C/W	1.19 C/W
	18	27mm	10.17 C/W	4.13 C/W	2.56 C/W	1.88 C/W		18	37.5mm	8.61 C/W	2.52 C/W	1.53 C/W	1.05 C/W
	21	27mm	9.56 C/W	3.82 C/W	2.32 C/W	1.72 C/W		21	37.5mm	8.11 C/W	2.25 C/W	1.36 C/W	.88 C/W
	23	27mm	9.44 C/W	3.51 C/W	2.11 C/W	1.6 C/W		23	37.5mm	7.98 C/W	2.04 C/W	1.2 C/W	.75 C/W
28	27mm	9.13 C/W	3.26 C/W	1.97 C/W	1.49 C/W	28		37.5mm	7.63 C/W	1.82 C/W	1.01 C/W	.63 C/W	
905	33	27mm	8.82 C/W	3.07 C/W	1.82 C/W	1.39 C/W	33	37.5mm	7.29 C/W	1.6 C/W	.87 C/W	.52 C/W	
	12	29mm	11.04 C/W	4.08 C/W	2.55 C/W	1.98 C/W	910	12	40mm	9.18 C/W	2.84 C/W	1.86 C/W	1.36 C/W
	15	29mm	10.46 C/W	3.82 C/W	2.32 C/W	1.78 C/W		15	40mm	8.71 C/W	2.64 C/W	1.65 C/W	1.18 C/W
	18	29mm	9.87 C/W	3.58 C/W	2.14 C/W	1.58 C/W		18	40mm	8.24 C/W	2.4 C/W	1.44 C/W	.98 C/W
	21	29mm	9.28 C/W	3.33 C/W	1.96 C/W	1.44 C/W		21	40mm	7.77 C/W	2.21 C/W	1.27 C/W	.86 C/W
	23	29mm	9.16 C/W	3.13 C/W	1.82 C/W	1.34 C/W		23	40mm	7.63 C/W	2 C/W	1.15 C/W	.73 C/W
28	29mm	8.84 C/W	2.82 C/W	1.64 C/W	1.2 C/W	28		40mm	7.27 C/W	1.77 C/W	.99 C/W	.62 C/W	
906	33	29mm	8.53 C/W	2.59 C/W	1.47 C/W	1.07 C/W	33	40mm	6.92 C/W	1.58 C/W	.85 C/W	.51 C/W	

Material: AL 6063  
Finish: Black Anodize

Series	Chip Size	Construction	Height	Chip Height	Finish	Interface
901	19-	2- Pin Fin	12- 11.6 15- 14.6 18- 17.6 21- 20.6 23- 22.6 28- 27.6 33- 32.6	1- 9-2.1 2- 2.2-3.4	B = BLK ANO	0 = None 1 = T725
	21					
	23					
	27					
	29					
	31					
	33					
	35					
	37.5					

Refer to Page 33 for  
Installation Instructions



## ELLIPTICAL FIN HEAT SINK

### 900 SERIES



Wakefield-Vette's **900 Series** Heat Sinks for Chipset can match up to devices from Intel, Xilinx, TI, Motorola, ATI, AMD, Nvidia, Vishay, Powerex, Infineon, Microsemi, and many more.

These heat sinks are designed for air flow applications in the Telecom, Data Center, Networking, Cloud Computing, and many more Industries.

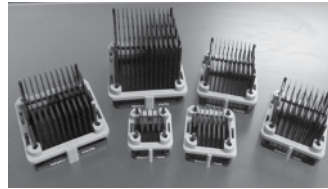

Series	Height	Chip Size	Natural Convection	Forced Convection			Series	Height	Chip Size	Natural Convection	Forced Convection		
				200 LFM	400 LFM	600 LFM					200 LFM	400 LFM	600 LFM
901	12	19mm	12.74 C/W	6.6 C/W	4.79 C/W	4.16 C/W	906	12	31mm	10.71 C/W	3.49 C/W	2.28 C/W	1.69 C/W
	15	19mm	12.05 C/W	6.3 C/W	4.51 C/W	3.86 C/W		15	31mm	10.14 C/W	3.18 C/W	2.03 C/W	1.5 C/W
	18	19mm	11.35 C/W	5.97 C/W	4.16 C/W	3.47 C/W		18	31mm	9.57 C/W	2.93 C/W	1.86 C/W	1.33 C/W
	21	19mm	10.66 C/W	5.66 C/W	3.89 C/W	3.21 C/W		21	31mm	9.01 C/W	2.72 C/W	1.69 C/W	1.2 C/W
	23	19mm	10.55 C/W	5.36 C/W	3.64 C/W	2.99 C/W		23	31mm	8.88 C/W	2.5 C/W	1.54 C/W	1.07 C/W
	28	19mm	10.27 C/W	4.91 C/W	3.36 C/W	2.71 C/W		28	31mm	8.56 C/W	2.26 C/W	1.38 C/W	.96 C/W
	33	19mm	9.99 C/W	4.52 C/W	3.07 C/W	2.49 C/W	33	31mm	8.24 C/W	2.09 C/W	1.27 C/W	.88 C/W	
902	12	21mm	12.4 C/W	6.61 C/W	4.37 C/W	3.7 C/W	907	12	33mm	10.37 C/W	3.32 C/W	2.18 C/W	1.62 C/W
	15	21mm	11.73 C/W	5.84 C/W	4.09 C/W	3.42 C/W		15	33mm	9.82 C/W	3.14 C/W	1.99 C/W	1.45 C/W
	18	21mm	11.06 C/W	5.51 C/W	3.76 C/W	3.07 C/W		18	33mm	9.28 C/W	2.89 C/W	1.78 C/W	1.3 C/W
	21	21mm	10.38 C/W	5.20 C/W	3.49 C/W	2.84 C/W		21	33mm	8.73 C/W	2.67 C/W	1.60 C/W	1.13 C/W
	23	21mm	10.27 C/W	4.9 C/W	3.26 C/W	2.62 C/W		23	33mm	8.60 C/W	2.45 C/W	1.43 C/W	.99 C/W
	28	21mm	9.98 C/W	4.55 C/W	2.98 C/W	2.42 C/W		28	33mm	8.27 C/W	2.24 C/W	1.28 C/W	.87 C/W
	33	21mm	9.7 C/W	4.18 C/W	2.73 C/W	2.21 C/W	33	33mm	7.94 C/W	2.03 C/W	1.15 C/W	.77 C/W	
903	12	23mm	12.06 C/W	5.72 C/W	3.95 C/W	3.24 C/W	908	12	35mm	10.03 C/W	3.06 C/W	1.97 C/W	1.49 C/W
	15	23mm	11.41 C/W	5.39 C/W	3.67 C/W	2.99 C/W		15	35mm	9.5 C/W	2.85 C/W	1.81 C/W	1.34 C/W
	18	23mm	10.76 C/W	5.05 C/W	3.35 C/W	2.67 C/W		18	35mm	8.98 C/W	2.6 C/W	1.64 C/W	1.19 C/W
	21	23mm	10.11 C/W	4.74 C/W	3.1 C/W	2.46 C/W		21	35mm	8.46 C/W	2.4 C/W	1.5 C/W	1.07 C/W
	23	23mm	9.99 C/W	4.44 C/W	2.87 C/W	2.31 C/W		23	35mm	8.32 C/W	2.19 C/W	1.34 C/W	.97 C/W
	28	23mm	9.70 C/W	4.09 C/W	2.62 C/W	2.12 C/W		28	35mm	7.99 C/W	1.97 C/W	1.19 C/W	.83 C/W
	33	23mm	9.41 C/W	3.83 C/W	2.43 C/W	1.96 C/W	33	35mm	7.65 C/W	1.82 C/W	1.06 C/W	.7 C/W	
904	12	27mm	11.38 C/W	4.84 C/W	3.11 C/W	2.32 C/W	909	12	37.5mm	9.60 C/W	2.93 C/W	1.90 C/W	1.36 C/W
	15	27mm	10.78 C/W	4.48 C/W	2.84 C/W	2.12 C/W		15	37.5mm	9.11 C/W	2.71 C/W	1.72 C/W	1.19 C/W
	18	27mm	10.17 C/W	4.13 C/W	2.56 C/W	1.88 C/W		18	37.5mm	8.61 C/W	2.52 C/W	1.53 C/W	1.05 C/W
	21	27mm	9.56 C/W	3.82 C/W	2.32 C/W	1.72 C/W		21	37.5mm	8.11 C/W	2.25 C/W	1.36 C/W	.88 C/W
	23	27mm	9.44 C/W	3.51 C/W	2.11 C/W	1.6 C/W		23	37.5mm	7.98 C/W	2.04 C/W	1.2 C/W	.75 C/W
	28	27mm	9.13 C/W	3.26 C/W	1.97 C/W	1.49 C/W		28	37.5mm	7.63 C/W	1.82 C/W	1.01 C/W	.63 C/W
	33	27mm	8.82 C/W	3.07 C/W	1.82 C/W	1.39 C/W	33	37.5mm	7.29 C/W	1.6 C/W	.87 C/W	.52 C/W	
905	12	29mm	11.04 C/W	4.08 C/W	2.55 C/W	1.98 C/W	910	12	40mm	9.18 C/W	2.84 C/W	1.86 C/W	1.36 C/W
	15	29mm	10.46 C/W	3.82 C/W	2.32 C/W	1.78 C/W		15	40mm	8.71 C/W	2.64 C/W	1.65 C/W	1.18 C/W
	18	29mm	9.87 C/W	3.58 C/W	2.14 C/W	1.58 C/W		18	40mm	8.24 C/W	2.4 C/W	1.44 C/W	.98 C/W
	21	29mm	9.28 C/W	3.33 C/W	1.96 C/W	1.44 C/W		21	40mm	7.77 C/W	2.21 C/W	1.27 C/W	.86 C/W
	23	29mm	9.16 C/W	3.13 C/W	1.82 C/W	1.34 C/W		23	40mm	7.63 C/W	2 C/W	1.15 C/W	.73 C/W
	28	29mm	8.84 C/W	2.82 C/W	1.64 C/W	1.2 C/W		28	40mm	7.27 C/W	1.77 C/W	.99 C/W	.62 C/W
	33	29mm	8.53 C/W	2.59 C/W	1.47 C/W	1.07 C/W	33	40mm	6.92 C/W	1.58 C/W	.85 C/W	.51 C/W	

Material: AL 6063  
Finish: Black Anodize

Series	Chip Size	Construction	Height	Chip Height	Finish	Interface
901-	19-	1-	12-	1-	B-	1
XXX	XX	X	XX	X	X	X
901	19	1= Elliptical Fin	12 = 11.6	1 = .9-2.1	B = BLK ANO	0 = None
902	21	2= Pin Fin	15 = 14.6	2 = 2.2-3.4		1 = T725
903	23		18 = 17.6			
904	27		21 = 20.6			
905	29		23 = 22.6			
906	31		28 = 27.6			
907	33		33 = 32.6			
908	35					
909	37.5					
910	40					

Refer to Page 33 for  
Installation Instructions

## PIN FIN & ELLIPTICAL FIN HEAT SINK

### 900 SERIES

Wakefield-Vette's heat sink assembles onto chip set using the space that is between the PCB and the substrate of the solder balls. The solder balls provide a minimal gap of .5mm to .7mm. Attachment feature is below a .4mm thickness. The clipping system will not interfere or damage chip. Contact area is the edge of chip.

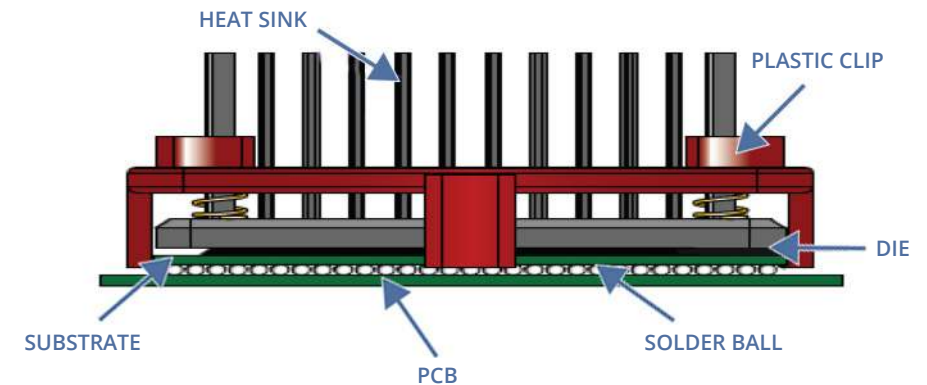
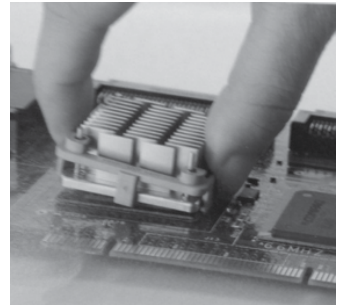

### ASSEMBLY INSTRUCTIONS:

**Step 1**  
Hook the clip under one side of the BGA chip set.

**Step 2**  
Rotate assembly down until opposite side clip engages substrate edge of BGA chip set.

**Step 3**  
Make sure the solder rods are clearing from edges of BGA chip set.

**Step 4**  
Press firmly down to make sure clips fully engage edges of chip set. Heat Sink should not move around easily.

### RANDOM VIBRATION TEST

Frequency: 5 Hz to 500 Hz  
Acceleration: 3.13 grms  
P.S.D: 0.01 g<sup>2</sup>/HZ (5 Hz)  
0.02 g<sup>2</sup>/HZ (20 Hz to 500 Hz)  
Test Axis: X, Y, Z axis  
Test Time: 10 mins (Each axis)  
Total Test Time: 30 mins

### SHOCK TEST SPECIFICATION:

Wave Form: Half sine wave  
Acceleration: 50 g  
Duration Time: 11 ms  
No. of Shock: Each axis 3 times  
Shock Direction: ±X, ±Y, ±Z axis  
Reliability & Communication Testing Instruments



## CERAMIC HEAT SINK FOR TO DEVICES W/ omniKlip



### CE-OMNI-38 HEAT SINK



Wakefield-Vette introduces heat sinks made from alumina and aluminum nitride for thermal management of high-power/ voltage electronics, photovoltaic, LED, power resistors and other applications. While electrically insulating and thermally conducting, the ceramic heat sink is an effective combination for the circuit board and heat sink reliability of cooling thermally sensitive components and circuits. The power chip dies can be directly bonded onto ceramic heat sink as a module substrate to eliminate the thermal barriers to quickly dissipate the generated heat. These heat sinks extend component life and enhance performance.

omniKlip™

#### FEATURES

- An innovative ceramic (Patent Pending) heat sink with unique design combines the tin plated solderable integral omniKlip spring with a molded aluminum oxide (Al<sub>2</sub>O<sub>3</sub>) or aluminum nitride (AlN) heat sink body to be mountable onto the PCB directly with no other fasteners needed. Unlike any others, this type of heat sink provides ease of assembly and an all-in-one solution (one part does all). It can be used with different package devices, such as TO-220, TO-247, TO-264 and TO-218 package, etc. series power devices with either natural or forced convection cooling.

WkV Part Number	Description	Package Cooled	Attachment Method	Length	Width	Height Off Base (Fin Height)	Thermal Resistance @ Forced Air Flow	Thermal Resistance @ Natural
CE-OMNI-38	Ceramic Heat Sink for TO Devices w/omniKlip	TO-220, TO-247	Solderable Feet	38.4mm	34mm	9.2mm	3.8°C/W @ 200 LFM	7.0°C/W @ 200 LFM

Material: 95% Al<sub>2</sub>O<sub>3</sub>, Surface Area: 11,408mm<sup>2</sup>, Weight: 22 g  
RoHS Compliant

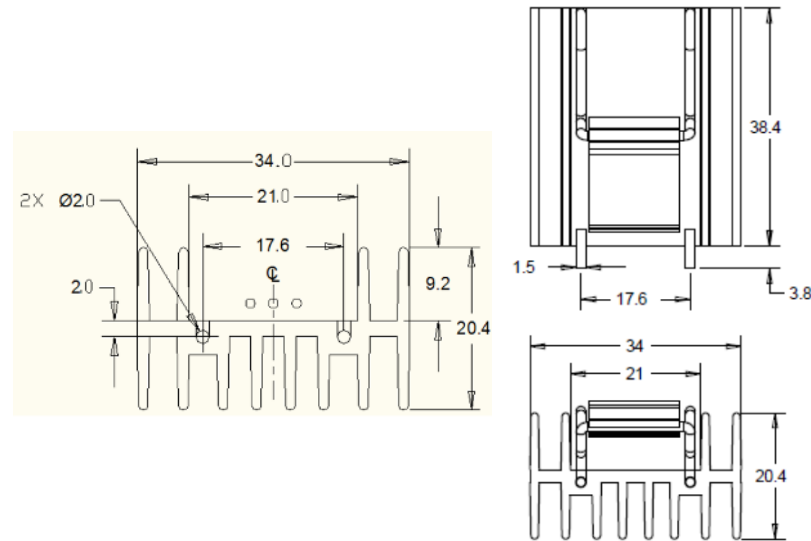
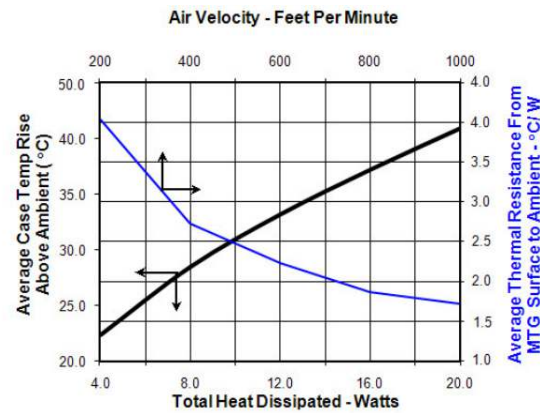

Common Ceramic Heat sinks are a rectangular or square shape ceramic as commonly seen in an extrusion heat sink that provides the most common use in cooling. It can be used as Chip-on-heat-sink (on the metalized surface) and makes it possible to achieve an extremely compact design for the entire cooling system. Using ceramic as the material for a heat sink ensures outstanding thermal conductivity and electrical insulation; the closer it is used to a source of heat, the greater the cooling advantage it offers.

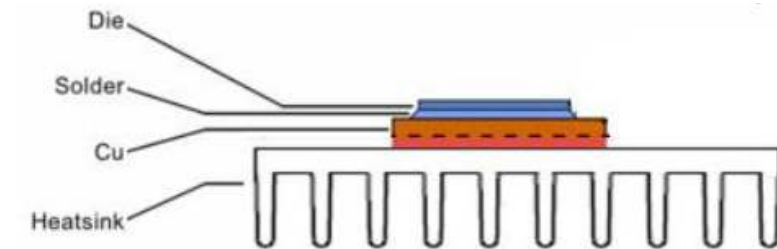
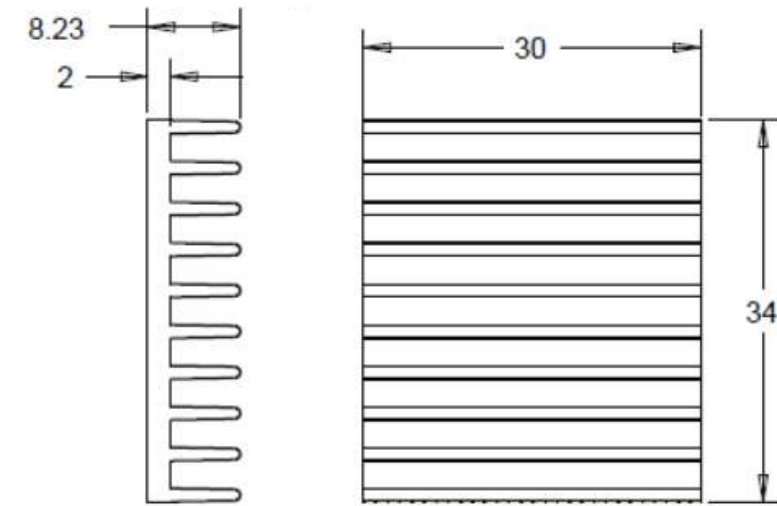

Material: 95% Al<sub>2</sub>O<sub>3</sub>, Surface Area: 5,979mm<sup>2</sup>, Weight: 15 g

Additional Configurations & Custom Ceramic Heat Sinks  
Contact Wakefield-Vette for more information or visit [www.wakefield-vette.com](http://www.wakefield-vette.com)

# WAVE SERIES HEAT SINK WITH INTEGRATED CLIP ASSEMBLY



## WAVE SERIES BGA HEAT SINKS



The Wakefield-Vette **Wave Series Heat Sink Series** are a superior choice for cooling BGA applications in which limited height/footprint while achieving maximum surface area. The Wave Series Heat Sinks include a unique clipping mechanism that allows for superior heat transfer while securing the heat sink to the BGA itself. The clipping mechanism allows for easy installation in high production assembly.

### FEATURES AND BENEFITS

- Approximately 12% better thermal performance than traditional footprint heat sinks.
- Height- A low profile design allows for more surface area in a height restricted application.
- Clipping mechanism included with heat sink.
- Surface Area - Fin array allows for more surface area for forced convection.
- Easily customizable.
- Easily compatible with major BGA device manufacturers components such as: Motorola, Freescale, TI, Intel, etc.

WkV Part Number	Description	Attachment Method	Mechanical Dimensions (mm)						Thermal Resistance - Forced Conv. @ 200 LFM
			Length	Width	Fin Width	Height	Surface Area (sq mm)	Height Off Base (Fin Height)	
WAVE-23-125	Wave Heat Sink BGA Chipset Aluminum Top Mount	Spring-Anchor	23	23	40	12.5	6055.1	10.5	6.76
WAVE-23-165	Wave Heat Sink BGA Chipset Aluminum Top Mount	Spring-Anchor	23	23	46.5	16.5	7634.6	14.5	5.08
WAVE-26-12	Wave Heat Sink BGA Chipset Aluminum Top Mount	Spring-Anchor	26	26	52.9	12	8305.2	10	5.21
WAVE-29-127	Wave Heat Sink BGA Chipset Aluminum Top Mount	Spring-Anchor	29	29	61.4	12.7	11810.5	10.7	4.08
WAVE-32-12	Wave Heat Sink BGA Chipset Aluminum Top Mount	Spring-Anchor	32	32	50.2	12	10957.5	10	4.64
WAVE-34-21	Wave Heat Sink BGA Chipset Aluminum Top Mount	Spring-Anchor	34	34	70	21	21268.4	19	2.19
WAVE-35-12	Wave Heat Sink BGA Chipset Aluminum Top Mount	Spring-Anchor	35	35	62	12	15180.8	10	3.83
WAVE-35-125	Wave Heat Sink BGA Chipset Aluminum Top Mount	Spring-Anchor	35	35	63.3	12.5	15792.6	10.5	3.63
WAVE-35-15	Wave Heat Sink BGA Chipset Aluminum Top Mount	Spring-Anchor	35	35	58.1	15	15612.7	13	3.15
WAVE-35-21	Wave Heat Sink BGA Chipset Aluminum Top Mount	Spring-Anchor	35	35	74.6	21	21721.8	19	2.11
WAVE-366-175	Wave Heat Sink BGA Chipset Aluminum Top Mount	Spring-Anchor	36.6	36.6	63.6	17.5	18637.8	15.5	2.55
WAVE-40-12	Wave Heat Sink BGA Chipset Aluminum Top Mount	Spring-Anchor	40	40	66.9	12	17689.4	10	3.36
WAVE-40-125	Wave Heat Sink BGA Chipset Aluminum Top Mount	Spring-Anchor	40	40	68.3	12.5	18410.1	10.5	3.16
WAVE-425-117	Wave Heat Sink BGA Chipset Aluminum Top Mount	Spring-Anchor	42.5	42.5	67.4	11.7	21668.3	9.3	3.40
WAVE-45-12	Wave Heat Sink BGA Chipset Aluminum Top Mount	Spring-Anchor	45	45	72	12	22303.7	10	2.96

**Material Specifications:** Heat Sink: Aluminum Alloy 6063-T5 with black anodized finish. Spring Clip: 304 Stainless Steel, 1.2mm [0.47"] DIA  
RoHS Compliant

## BGA HEAT SINKS WAVE 2X SERIES

WkV Part Number	Description	Attachment Method	Mechanical Dimensions (mm)						Thermal Resistance - Forced Conv. @ 200 LFM
			Length	Width	Fin Width	Height	Surface Area (sq mm)	Height Off Base (Fin Height)	
WAVE-23-125	Wave Heat Sink BGA Chipset Aluminum Top Mount	Spring-Anchor	23	23	40	12.5	6055.1	10.5	6.76
WAVE-23-165	Wave Heat Sink BGA Chipset Aluminum Top Mount	Spring-Anchor	23	23	46.5	16.5	7634.6	14.5	5.08

### WAVE-23-125

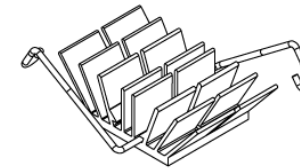

#### MECHANICAL DIMENSIONS

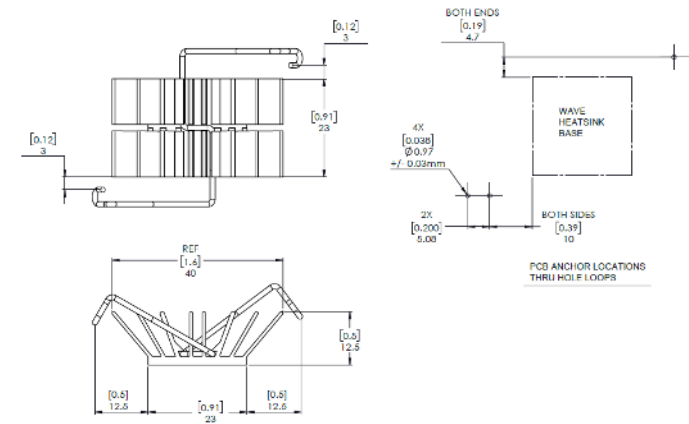

### WAVE-23-165

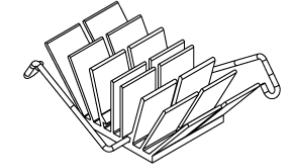

#### MECHANICAL DIMENSIONS

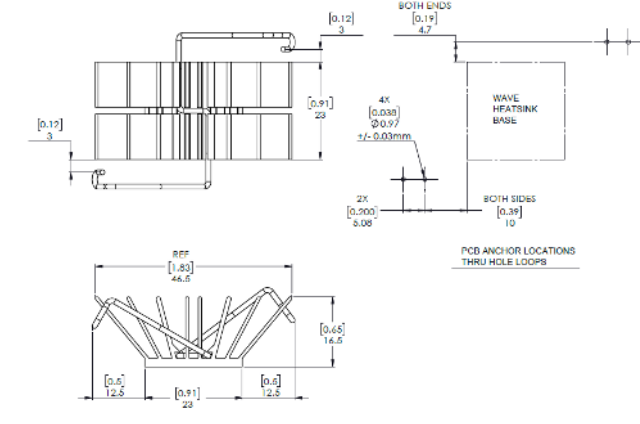

Wave 2X

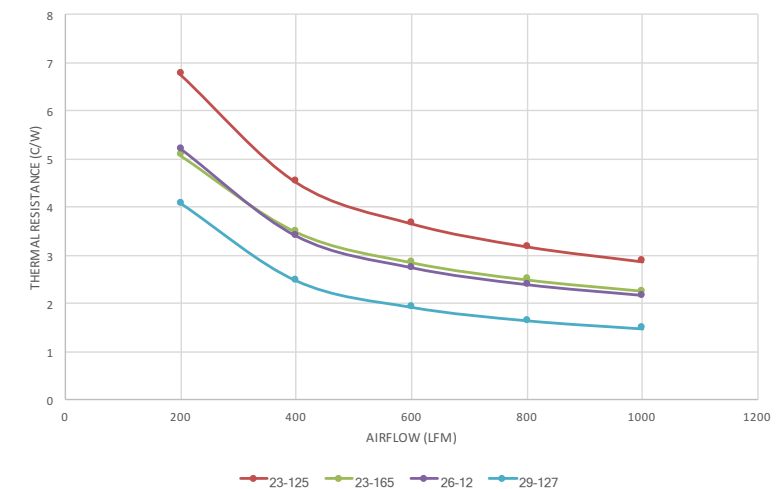

# WAVE SERIES HEAT SINK WITH INTEGRATED CLIP ASSEMBLY

## WAVE 2X SERIES

BGA HEAT SINKS

WkV Part Number	Description	Attachment Method	Mechanical Dimensions (mm)							Thermal Resistance - Forced Conv. @ 200 LFM
			Length	Width	Fin Width	Height	Surface Area (sq mm)	Height Off Base (Fin Height)		
WAVE-26-12	Wave Heat Sink BGA Chipset Aluminum Top Mount	Spring-Anchor	26	26	52.9	12	8305.2	10	5.21	
WAVE-29-127	Wave Heat Sink BGA Chipset Aluminum Top Mount	Spring-Anchor	29	29	61.4	12.7	11810.5	10.7	4.08	

### WAVE-26-12



MECHANICAL DIMENSIONS

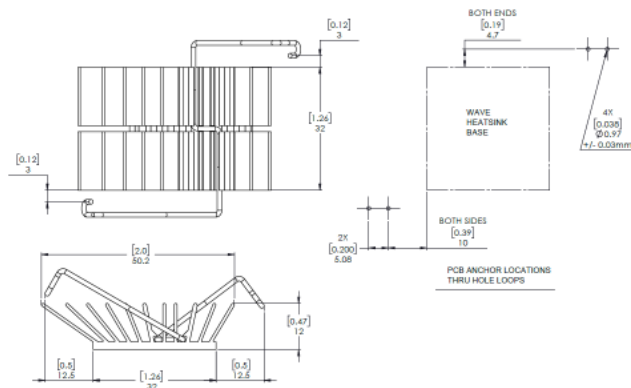

### WAVE-29-127



MECHANICAL DIMENSIONS

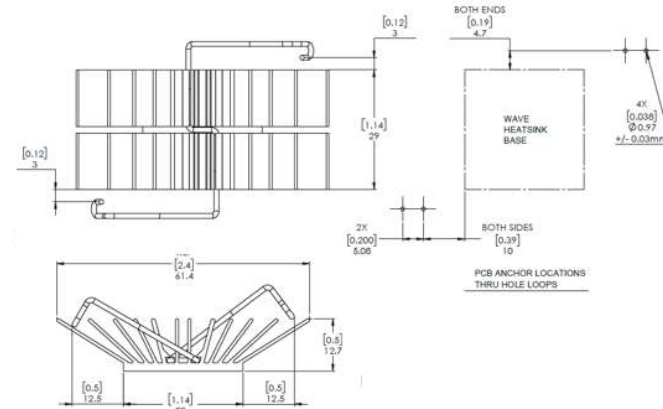

Wave 2X

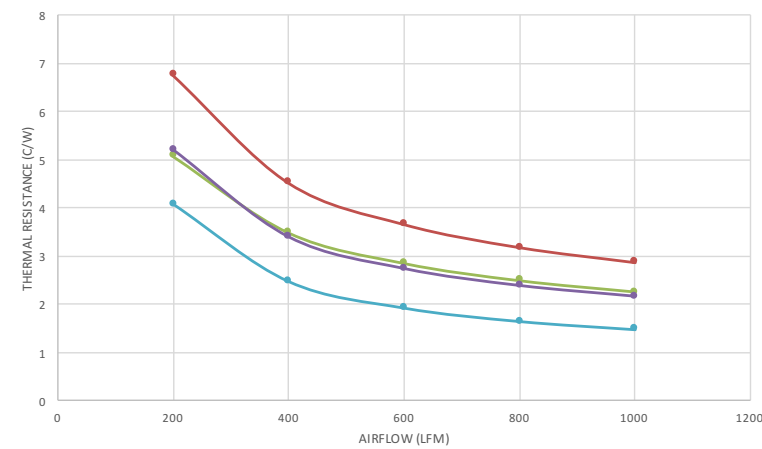

— 23-125 — 23-165 — 26-12 — 29-127

BGA HEAT SINKS

## WAVE 3X SERIES

WkV Part Number	Description	Attachment Method	Mechanical Dimensions (mm)							Thermal Resistance - Forced Conv. @ 200 LFM
			Length	Width	Fin Width	Height	Surface Area (sq mm)	Height Off Base (Fin Height)		
WAVE-32-12	Wave Heat Sink BGA Chipset Aluminum Top Mount	Spring-Anchor	32	32	50.2	12	10957.5	10	4.64	
WAVE-34-21	Wave Heat Sink BGA Chipset Aluminum Top Mount	Spring-Anchor	34	34	70	21	21268.4	19	2.19	

### WAVE-32-12

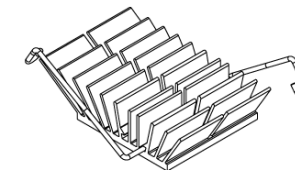

MECHANICAL DIMENSIONS

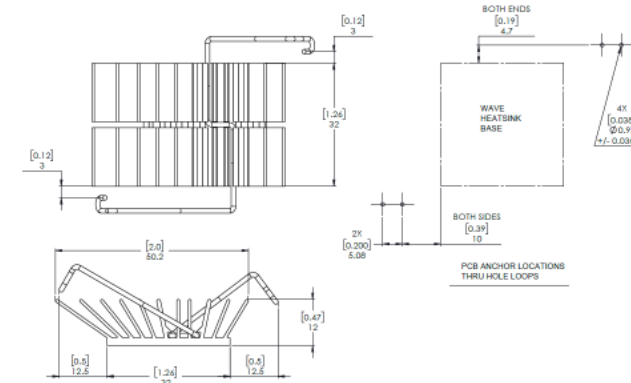

### WAVE-34-21

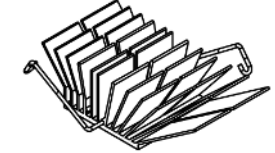

MECHANICAL DIMENSIONS

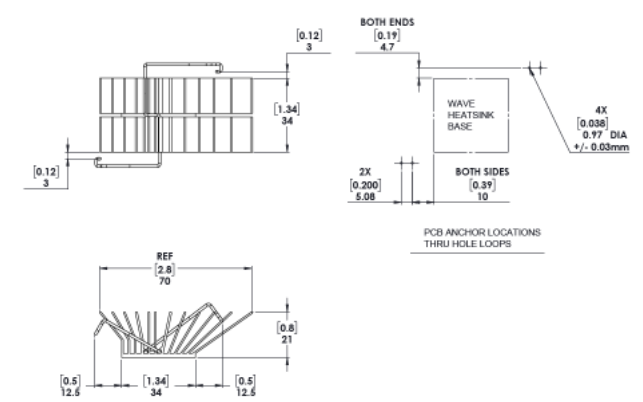

Wave 3X

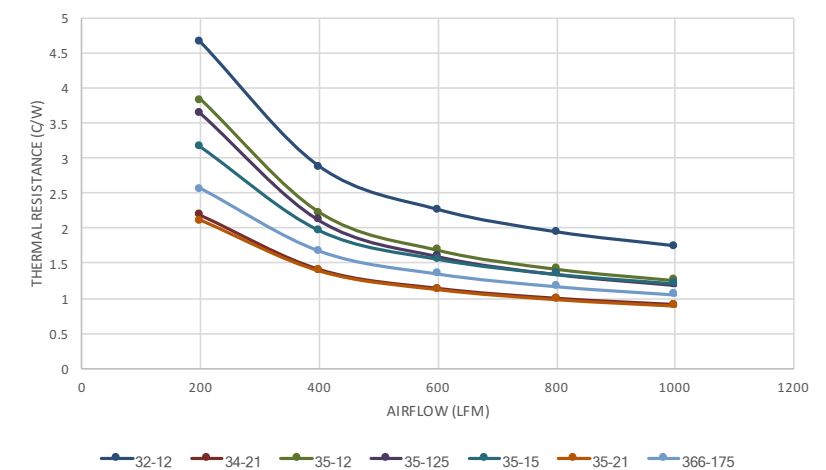

— 32-12 — 34-21 — 35-12 — 35-125 — 35-15 — 35-21 — 366-175



# WAVE SERIES HEAT SINK WITH INTEGRATED CLIP ASSEMBLY

BGA HEAT SINKS

**WAVE 3X SERIES**

**WAVE 3X SERIES**

BGA HEAT SINKS

WkV Part Number	Description	Attachment Method	Mechanical Dimensions (mm)						Thermal Resistance - Forced Conv. @ 200 LFM
			Length	Width	Fin Width	Height	Surface Area (sq mm)	Height Off Base (Fin Height)	
WAVE-35-12	Wave Heat Sink BGA Chipset Aluminum Top Mount	Spring-Anchor	35	35	62	12	15180.8	10	3.83
WAVE-35-125	Wave Heat Sink BGA Chipset Aluminum Top Mount	Spring-Anchor	35	35	63.3	12.5	15792.6	10.5	3.63

**WAVE-35-12**

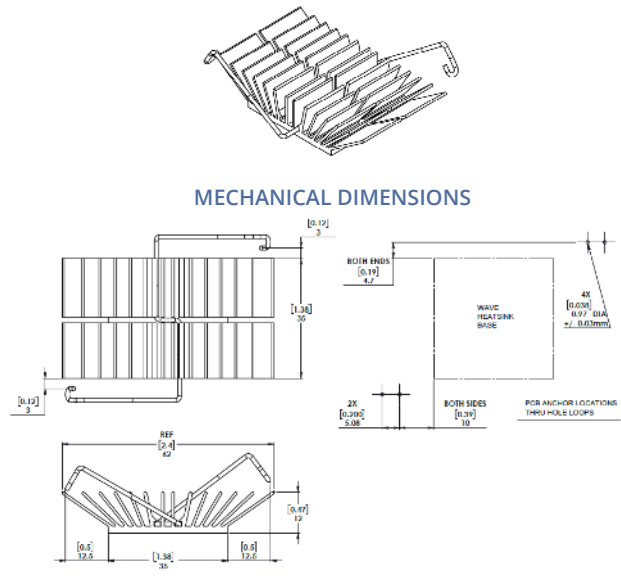

**WAVE-35-125**

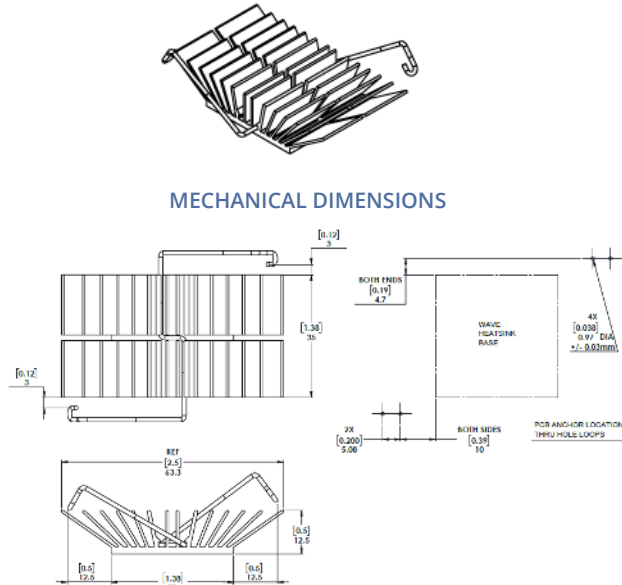

Wave 3X

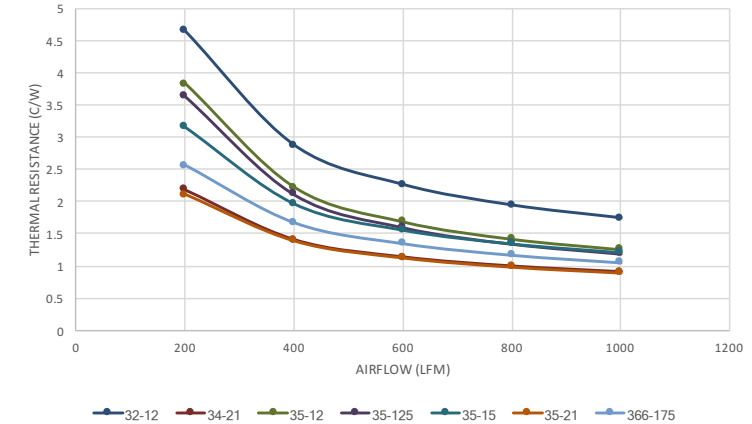

— 32-12 — 34-21 — 35-12 — 35-125 — 35-15 — 35-21 — 366-175

**WAVE-35-15**

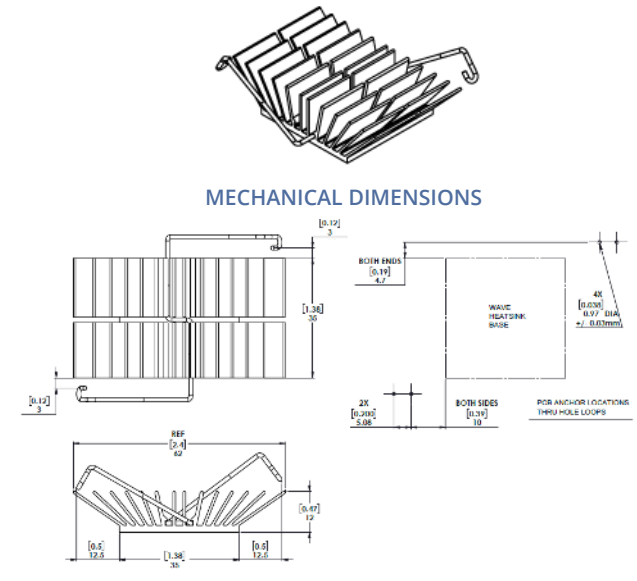

**WAVE-35-21**

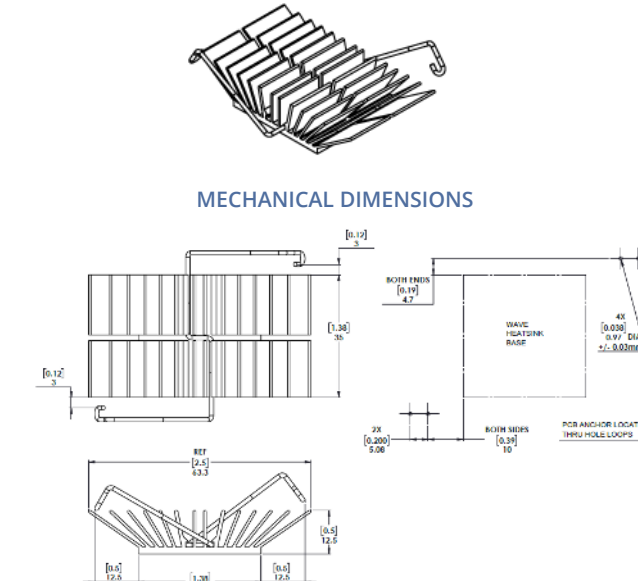

**WAVE-365-175**

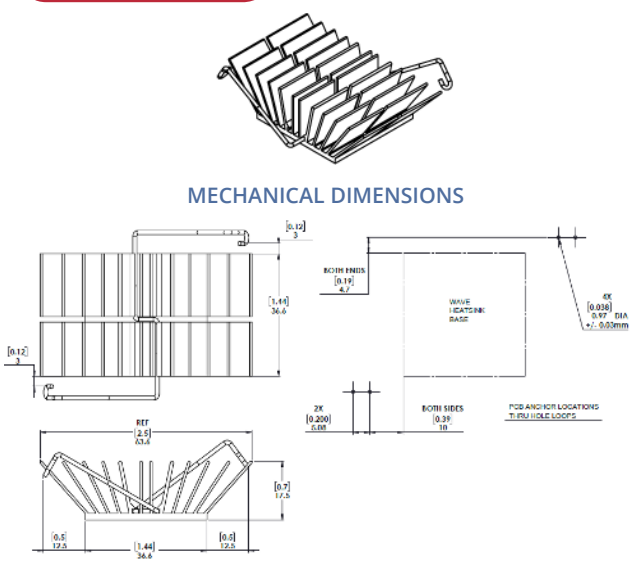

Wave 3X

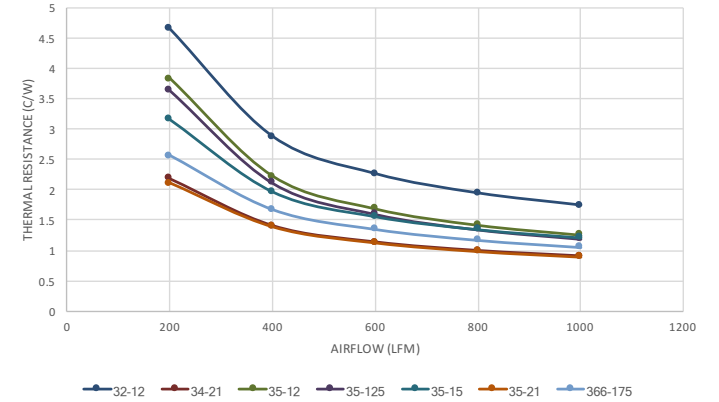

— 32-12 — 34-21 — 35-12 — 35-125 — 35-15 — 35-21 — 366-175

# WAVE SERIES HEAT SINK WITH INTEGRATED CLIP ASSEMBLY

## WAVE 4X SERIES

BGA HEAT SINKS

WkV Part Number	Description	Attachment Method	Mechanical Dimensions (mm)						Thermal Resistance - Forced Conv. @ 200 LFM
			Length	Width	Fin Width	Height	Surface Area (sq mm)	Height Off Base (Fin Height)	
WAVE-40-12	Wave Heat Sink BGA Chipset Aluminum Top Mount	Spring-Anchor	40	40	66.9	12	17689.4	10	3.36
WAVE-40-125	Wave Heat Sink BGA Chipset Aluminum Top Mount	Spring-Anchor	40	40	68.3	12.5	18410.1	10.5	3.16
WAVE-425-117	Wave Heat Sink BGA Chipset Aluminum Top Mount	Spring-Anchor	42.5	42.5	67.4	11.7	21668.3	9.3	3.40
WAVE-45-12	Wave Heat Sink BGA Chipset Aluminum Top Mount	Spring-Anchor	45	45	72	12	22303.7	10	2.96

### WAVE-40-12



#### MECHANICAL DIMENSIONS

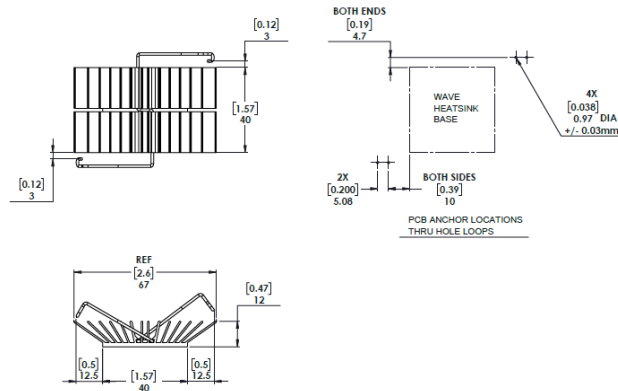

### WAVE-40-125



#### MECHANICAL DIMENSIONS

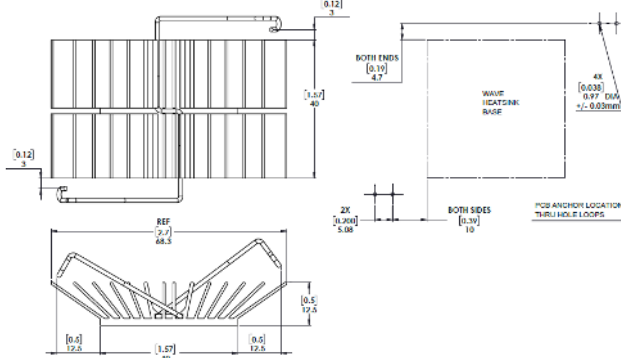

Wave 4X

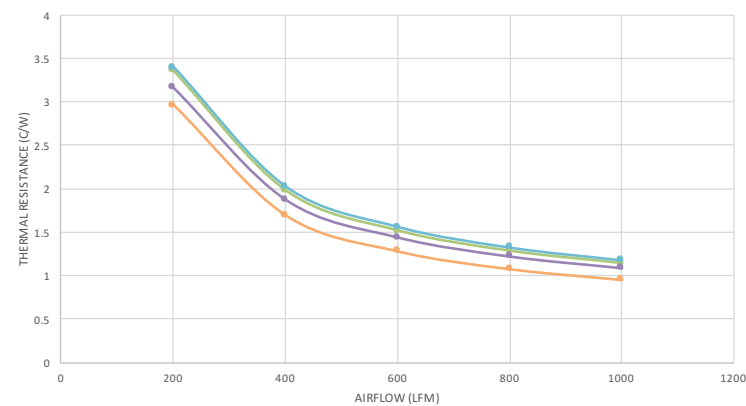

— 40-12 — 40-125 — 425-117 — 45-12

BGA HEAT SINKS

## WAVE 4X SERIES

WkV Part Number	Description	Attachment Method	Mechanical Dimensions (mm)						Thermal Resistance - Forced Conv. @ 200 LFM
			Length	Width	Fin Width	Height	Surface Area (sq mm)	Height Off Base (Fin Height)	
WAVE-40-12	Wave Heat Sink BGA Chipset Aluminum Top Mount	Spring-Anchor	40	40	66.9	12	17689.4	10	3.36
WAVE-40-125	Wave Heat Sink BGA Chipset Aluminum Top Mount	Spring-Anchor	40	40	68.3	12.5	18410.1	10.5	3.16
WAVE-425-117	Wave Heat Sink BGA Chipset Aluminum Top Mount	Spring-Anchor	42.5	42.5	67.4	11.7	21668.3	9.3	3.40
WAVE-45-12	Wave Heat Sink BGA Chipset Aluminum Top Mount	Spring-Anchor	45	45	72	12	22303.7	10	2.96

### WAVE-425-117

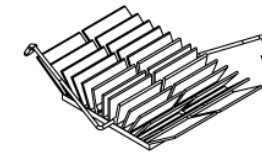

#### MECHANICAL DIMENSIONS

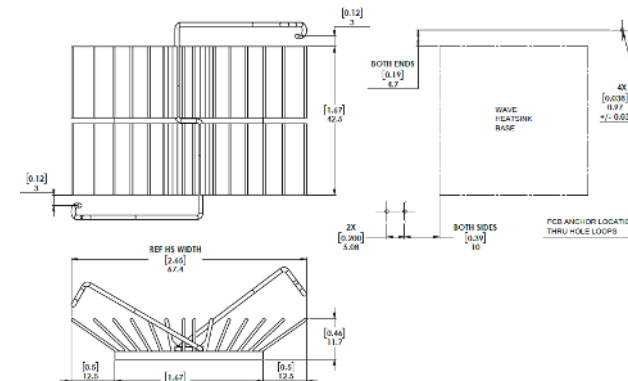

Wave 4X

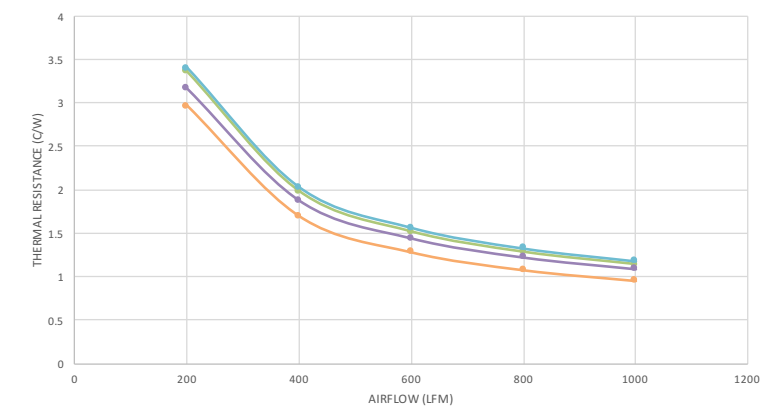

— 40-12 — 40-125 — 425-117 — 45-12

# BOARD LEVEL POWER SEMICONDUCTOR HEAT SINKS

<i>Board Level Power Semiconductor Heat Sinks</i> .....	46-76
<i>219 Series Heat Sinks for TO-263 Devices</i> .....	48-49
<i>Board Level Heat Sinks for TO-220, TO-218 &amp; Multiwatt™ Components</i> .....	59-61
<i>Universal 678 Series Vertical Heat Sink for Power Devices</i> .....	77
<i>One Heat Sink for all Packages</i> .....	78
<i>Mountain Series Heat Sinks for TO-264, TO-247 Devices</i> .....	79-80
<i>omniKlip™ Series Heat Sink w/ Clip(s) for TO-Devices</i> .....	81-83
<i>Additional Configurations</i> .....	84

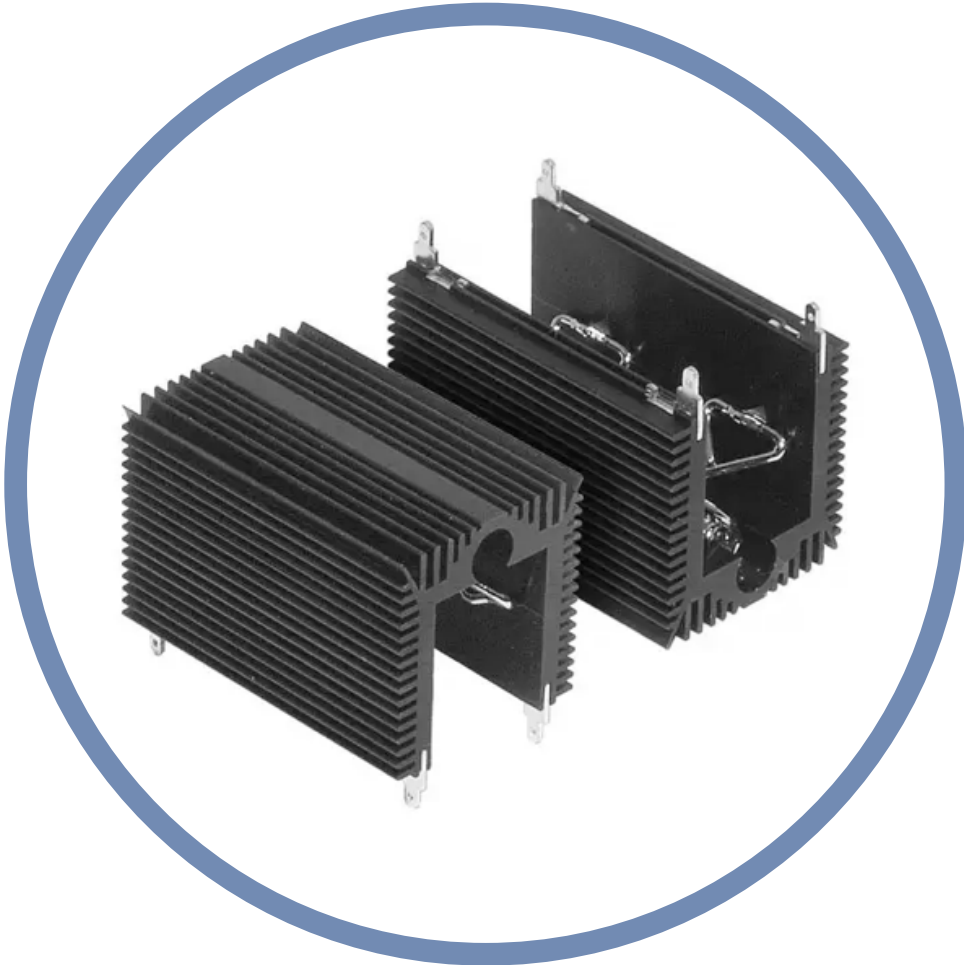

*A wide variety of heat dissipators with various attachment mechanisms for surface mount and thru-hole power semiconductors packaged in industry standard plastic, ceramic, and metal cases such as D2Pak, TO-220, TO-3 to TO-247, DO-4 to DO-11, multiwatt, hex-type, and stud mount devices.*



# BOARD LEVEL POWER SEMICONDUCTOR HEAT SINKS

## 217 SERIES SURFACE MOUNT HEAT SINKS

D2PAK; TO-220; SOT-223; SOL-20

Compatible with surface mount technology (SMT) automated production techniques for ease of assembly and a variety of soldering methods, these heat sinks allow greater packaging densities and reduction in PC-board area, increasing the power dissipation of surface mount devices (SMDs) while maintaining and improving manufacturers' component thermal specifications.

### FEATURES AND BENEFITS

- No interface material is needed
- Copper with matte tin plating for improved solderability and assembly
- Both the component and the heat sink are installed on the PC-board utilizing standard SMT assembly equipment for "Tape & Reel" and "Tube" formats
- EIA standards and ESD protection are specified
- Can be used with water soluble or no clean SMT solder creams or other pastes

Footprint Standard P/N	Height Above PC Board in. (mm)	Dimensions in. (mm)	Package Format	Package Quantity	Thermal Performance at Typical Load	
					Natural Convection	Forced Convection
217-36CTE6	.360 (9.1)	.600 (15.2) x .740 (18.8)	Bulk	1	55°C @ 1W	16.0°C/W @ 200 LFM
217-36CTTE6	.360 (9.1)	.600 (15.2) x .740 (18.8)	Tube	20	55°C @ 1W	16.0°C/W @ 200 LFM
217-36CTRE6	.360 (9.1)	.600 (15.2) x .740 (18.8)	Tape & Reel	250	55°C @ 1W	16.0°C/W @ 200 LFM

Material: Copper, Matte Tin Plated

### MECHANICAL DIMENSIONS

### THERMAL PERFORMANCE 6 LAYER BOARD, D' PAK 125°C LEAD, 40°C AMBIENT

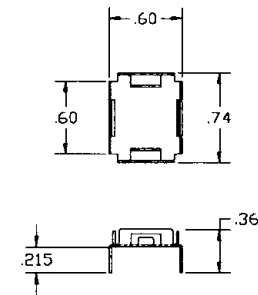

217-36CT6

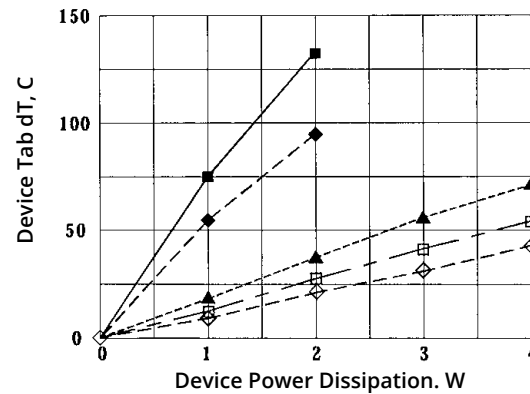

KEY: ■ Device only, NC ◆ Device + HS, NC ▲ Device + HS, 100 lfm □ Device + HS, 200 lfm ◇ Device + HS, 300 lfm

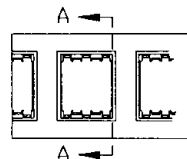

SECTION A-A

Dimensions: in.

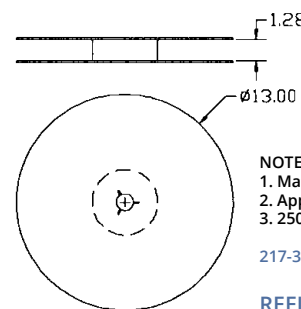

NOTES  
1. Material to be "ESD"  
2. Approximately 6 Meters per Reel  
3. 250 Pieces per Reel.

217-36CTR6

### REEL DETAILS

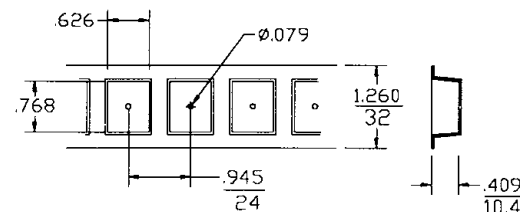

### TAPE DETAILS

D2PAK; TO-220; SOL-20

## SURFACE MOUNT HEAT SINKS

## 217 SERIES

### MECHANICAL DIMENSIONS

#### TUBE DETAILS

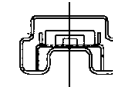
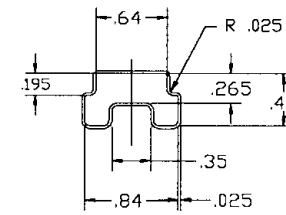

Tube: 16.25 Inches Long, Min. esd Material with Nail Stops  
20 Pieces per Tube

217-36CT6

Dimensions: in.

### BOARD LAYOUT RECOMMENDATIONS

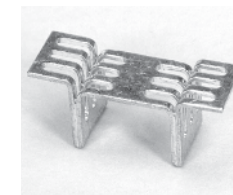
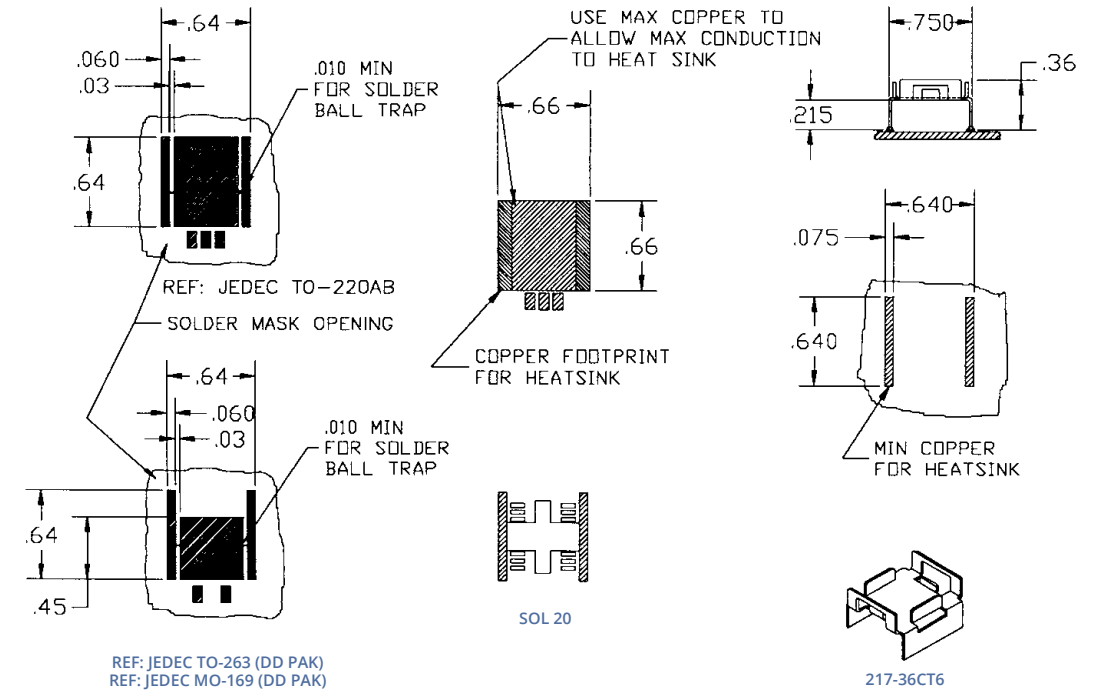

## 218 SERIES SURFACE MOUNT HEAT SINK

SMT Devices

Standard P/N	Height Above PC Board in. (mm)	Maximum Footprint in. (mm)	Thermal Performance at Typical Load	
			Natural Convection	Forced Convection
218-40CTE3	.40 (10.2)	.90 (22.9) x .315 (8.0)	62°C rise @ 2W	21°C/W @ 200LFM
218-40CTE5	.40 (10.2)	1.03 (26.2) x .50 (12.7)	62°C rise @ 2W	21°C/W @ 200LFM

Material: Copper, Matte Tin Plated

### MECHANICAL DIMENSIONS

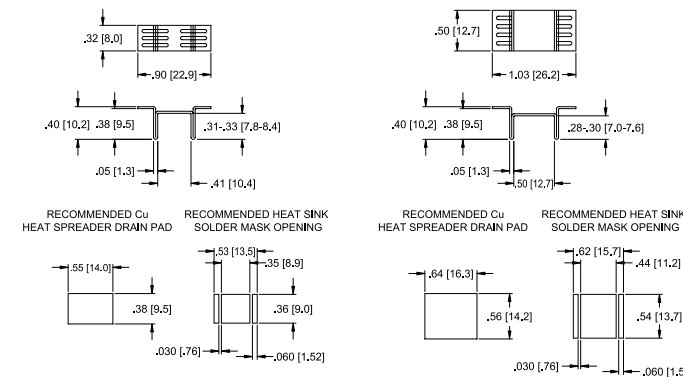

218-40CT3

218-40CT5

### NATURAL AND FORCED CONVECTION CHARACTERISTICS

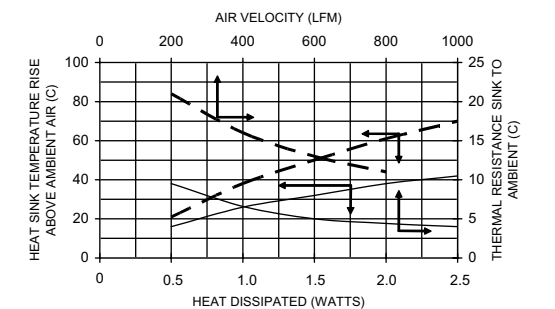

Solid line = 218-40CT5 Dashed Line = 218-40CT3

## 219 SERIES HEAT SINKS FOR TO-263 DEVICES

### 219-263A HEAT SINK FOR TO-263 DEVICES



Innovation in SMT compatible heat sinks to meet the needs of newer higher power SMT semiconductors. The 219 Series heat sinks unique design (Patent Pending) combines the technology of automatically assembling the tin plated solderable wires/rods with that of extruded aluminum anodized heat sink body to configure these SMT heat sinks. Rods/wires named "Rollers" are mated mechanically to the heat sink body by forging to reduce the interface thermal resistance between the drains & heat dissipation body.

#### FEATURES AND BENEFITS

- Increased thermal performance up to 30% over bright copper heat sinks from improved radiation of the black finish.
- Increased surface areas by 3 times therefore thermal performance up to 300% over the aluminum stamped heat sinks on markets.
- Light weight aluminum construction allows faster pick and place assembly reducing the manufacturing cycle time.
- Radius mounted "Rollers" are designed for maximizing heat transfer from component and to avoid "bottle neck" heat transfer like the Aluminum stamped heat sinks.
- Available in bulk packaging or Tape & Reel.

Part Number	Description	Attachment	Length	Width	Height Off Base (Height Of Fin)	Power Dissipation @ Temperature Rise	Thermal Resistance @ Forced Air Flow	Package Type
219-263A	TO-263 SMD HEAT SINK ANODZD	Solderable Feet	0.500" (12.70mm)	1.020" (25.91mm)	0.480" (12.19mm)	2W @ 30°C	8°C/W @ 500 LFM	Bulk

#### MECHANICAL DIMENSIONS

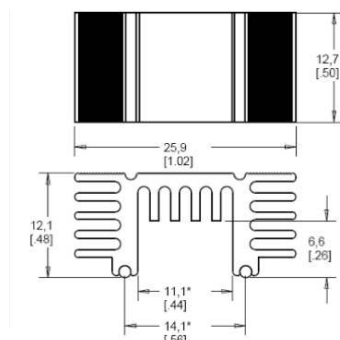
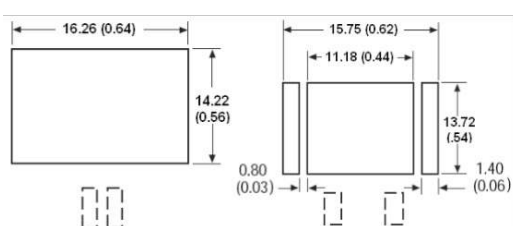

#### TAPE AND REEL INFORMATION

Reel diameter: 13.00" (330.00mm)  
250 pcs. per

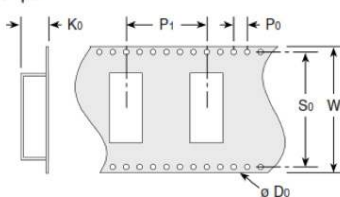

	Style 10	Style 20	Style 30
Do	1.55mm	1.5mm	1.5mm
Ko	10.5mm	12.20mm	11.50mm
Po	4mm	4.0mm	4.0mm
P1	24mm	24mm	24.0mm
So	40.4mm	40.4mm	52.4mm
W	44mm	44mm	56mm

#### THERMAL RESISTANCE

Air Velocity - Feet Per Minute

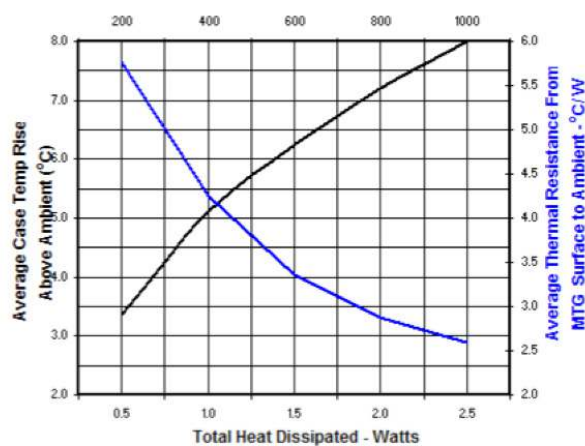

#### TAPE DETAILS



### HEAT SINK FOR TO-263 DEVICES 219-263A-TR



Innovation in SMT compatible heat sinks to meet the needs of newer higher power SMT semiconductors. The 219 Series heat sinks unique design (Patent Pending) combines the technology of automatically assembling the tin plated solderable wires/rods with that of extruded aluminum anodized heat sink body to configure these SMT heat sinks. Rods/wires named "Rollers" are mated mechanically to the heat sink body by forging to reduce the interface thermal resistance between the drains & heat dissipation body.

#### FEATURES AND BENEFITS

- Increased thermal performance up to 30% over bright copper heat sinks from improved radiation of the black finish.
- Increased surface areas by 3 times therefore thermal performance up to 300% over the aluminum stamped heat sinks on markets.
- Light weight aluminum construction allows faster pick and place assembly reducing the manufacturing cycle time.
- Radius mounted "Rollers" are designed for maximizing heat transfer from component and to avoid "bottle neck" heat transfer like the Aluminum stamped heat sinks.
- Available in bulk packaging or Tape & Reel.

Part Number	Description	Attachment	Length	Width	Height Off Base (Height Of Fin)	Power Dissipation @ Temperature Rise	Thermal Resistance @ Forced Air Flow	Package Type
219-263A-TR	TO-263 SMD HEAT SINK ANODZD	Solderable Feet	0.500" (12.70mm)	1.020" (25.91mm)	0.480" (12.19mm)	2W @ 30°C	8°C/W @ 500 LFM	Tape & Reel

#### MECHANICAL DIMENSIONS

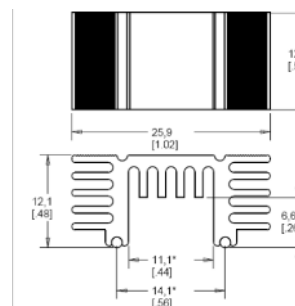
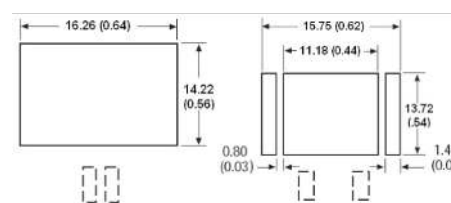

#### TAPE AND REEL INFORMATION

Reel diameter: 13.00" (330.00mm)  
250 pcs. per

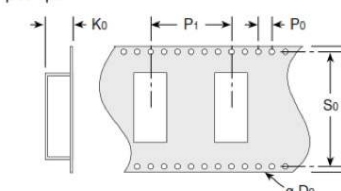

	Style 10	Style 20	Style 30
Do	1.55mm	1.5mm	1.5mm
Ko	10.5mm	12.20mm	11.50mm
Po	4mm	4.0mm	4.0mm
P1	24mm	24mm	24.0mm
So	40.4mm	40.4mm	52.4mm
W	44mm	44mm	56mm

#### THERMAL RESISTANCE

Air Velocity - Feet Per Minute

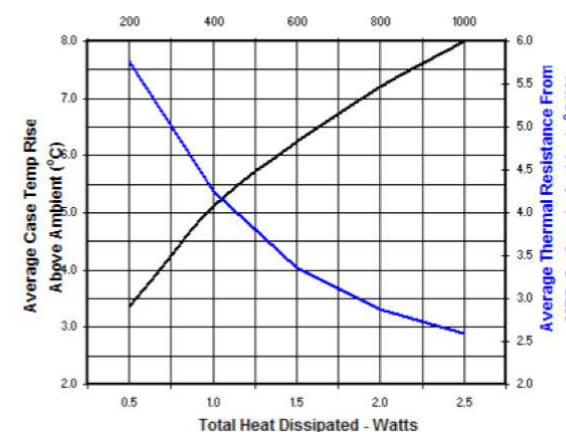

# BOARD LEVEL POWER SEMICONDUCTOR HEAT SINKS

## 206 SERIES

VERTICAL MOUNT HEAT SINK

TO-220

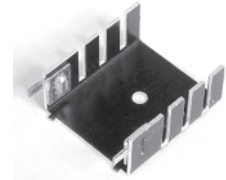

Standard P/N	Height Above PC Board in. (mm)	Maximum Footprint in. (mm)	Thermal Performance at Typical Load	
			Natural Convection	Forced Convection
206-1PABEH	1.18 (30.0)	1.00 (25.4) x .50 (12.7)	56°C rise @ 4W	7.3°C/W @ 200LFM

**Material:** Aluminum, Black Anodized

### MECHANICAL DIMENSIONS

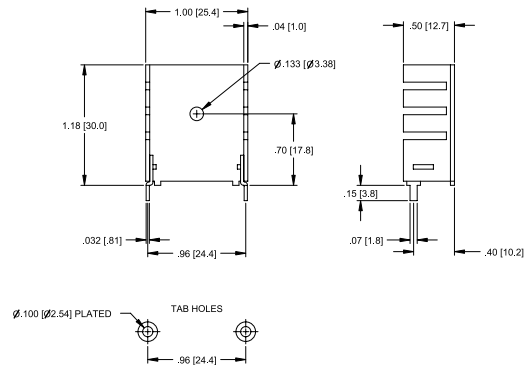

### NATURAL AND FORCED CONVECTION CHARACTERISTICS

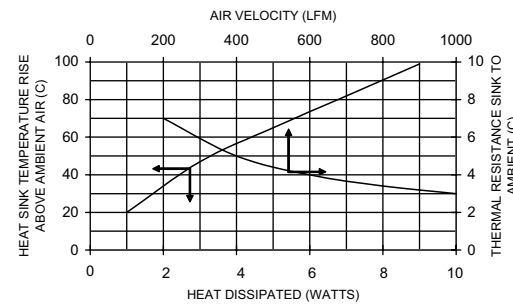

TO-220

HORIZONTAL MOUNT HEAT SINK

## 241 SERIES

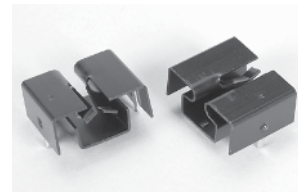

Standard P/N	Height Above PC Board in. (mm)	Maximum Footprint in. (mm)	Thermal Performance at Typical Load	
			Natural Convection	Forced Convection
241-69ABE-03	.39 (9.9)	.86 (21.8) x .69 (17.5)	77°C rise @ 4W	12°C/W @ 200LFM

**Material:** Aluminum, Black Anodized

### MECHANICAL DIMENSIONS

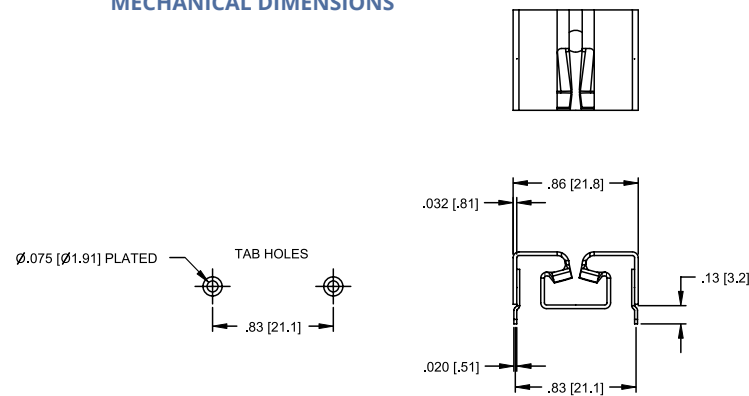

### NATURAL AND FORCED CONVECTION CHARACTERISTICS

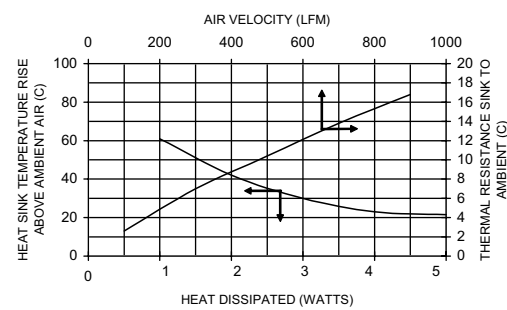

COMPACT, WAVE-SOLDERABLE LOW-PROFILE  
SELF-LOCKING HEAT SINKS

## 230 & 234 SERIES

TO-220

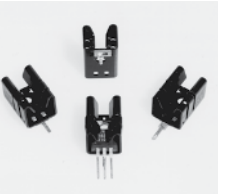

Standard P/N	Height Above PC Board in. (mm)	Footprint Dimensions in. (mm)	Mounting Configuration	Solderable Tab Option	Mounting Style	Thermal Performance at Typical Load	
						Natural Convection	Forced Convection
230-75AB	.750 (19.1)	.570 (14.5) x .500 (12.7)	Vert./Horiz.	No Tab	Clip/Mtg Hole	57°C @ 2W	7.5°C/W @ 400 LFM
230-75ABE-01	.750 (19.1)	.570 (14.5) x .500 (12.7)	Vertical	01	Clip/Mtg Hole	57°C @ 2W	7.5°C/W @ 400 LFM
230-75ABE-05	.500 (12.7)	.750 (19.1) x .570 (14.5)	Horizontal	05	Clip/Mtg Hole	57°C @ 2W	7.5°C/W @ 400 LFM
230-75ABE-10	.875 (22.2)	.570 (14.5) x .500 (12.7)	Vertical	10	Clip/Mtg Hole	57°C @ 2W	7.5°C/W @ 400 LFM
234-75AB	.790 (20.0)	.570 (14.5) x .500 (12.7)	Vert./Horiz.	No Tab	Clip/Mtg Hole	57°C @ 2W	7.5°C/W @ 400 LFM
234-75ABE-01	.790 (20.0)	.570 (14.5) x .500 (12.7)	Vertical	01	Clip/Mtg Hole	57°C @ 2W	7.5°C/W @ 400 LFM
234-75ABE-05	.500 (12.7)	.790 (20.0) x .570 (14.5)	Horizontal	05	Clip/Mtg Hole	57°C @ 2W	7.5°C/W @ 400 LFM

**Material:** Aluminum, Black Anodized

### MECHANICAL DIMENSIONS

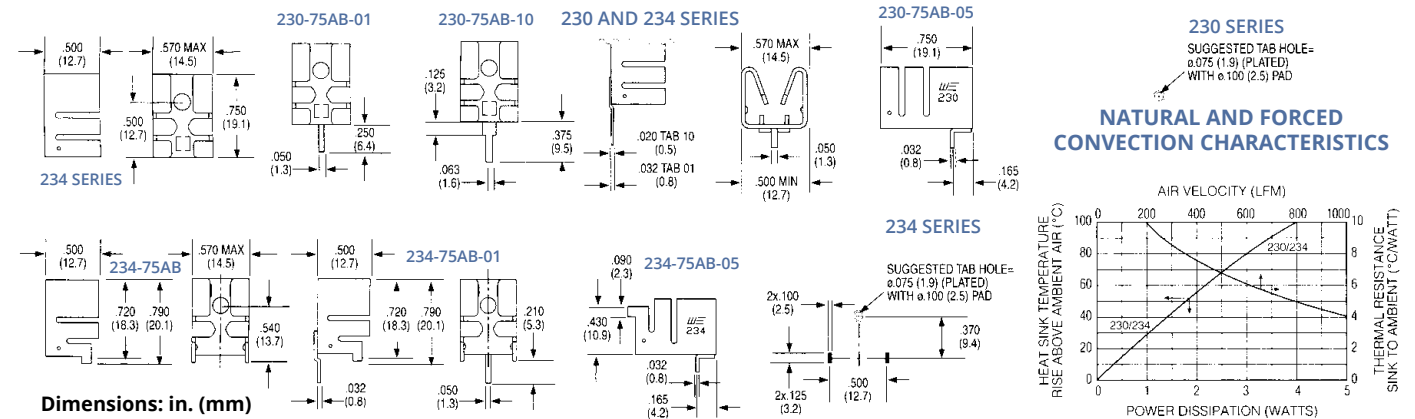

## 262 SERIES

HORIZONTAL AND VERTICAL MOUNT HEAT SINK

TO-220

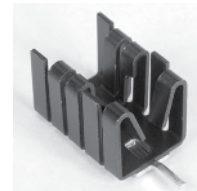

Standard P/N	Height Above PC Board in. (mm)	Maximum Footprint in. (mm)	Thermal Performance at Typical Load	
			Natural Convection	Forced Convection
262-75ABE-05	.53 (13.4)	.75 (19.1) x .50 (12.78)	80°C rise @ 2W	10°C/W @ 200LFM
262-75ABE-01	.75 (19.1)	.53 (13.4) x .50 (12.7)	80°C rise @ 2W	10°C/W @ 200LFM

**Material:** Aluminum, Black Anodized

### MECHANICAL DIMENSIONS

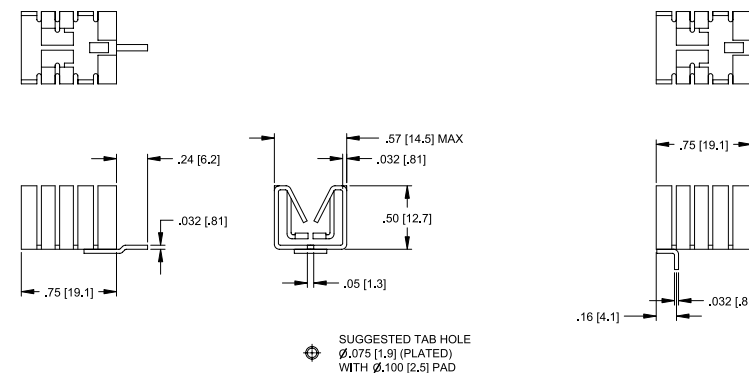

### NATURAL AND FORCED CONVECTION CHARACTERISTICS

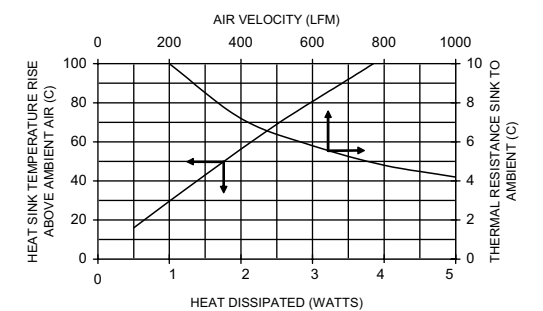



# BOARD LEVEL POWER SEMICONDUCTOR HEAT SINKS



## 233 & 236 SERIES

SELF-LOCKING WAVE-SOLDERABLE HEAT SINKS

TO-220

PATENT  
PENDING

Standard P/N	Height Above PC Board in. (mm)	Footprint Dimensions in. (mm)	Mounting Configuration	Solderable Tab Options	Mounting Style	Thermal Performance at Typical Load	
						Natural Convection	Forced Convection
233-60AB	.600(15.2)	.570 (14.5) x .500 (12.7)	Vert./Horiz.	No Tab	Clip/Mtg Hole	58°C @ 2W	11.0°C/W @ 400 LFM
233-60ABE-01	.600(15.2)	.570 (14.5) x .500 (12.7)	Vertical	01	Clip/Mtg Hole	58°C @ 2W	11.0°C/W @ 400 LFM
233-60ABE-05	.500(12.7)	.600 (15.2) x .570 (14.5)	Horizontal	05	Clip/Mtg Hole	58°C @ 2W	11.0°C/W @ 400 LFM
233-60ABE-10	.725(18.4)	.570 (14.5) x .500 (12.7)	Vertical	10	Clip/Mtg Hole	58°C @ 2W	11.0°C/W @ 400 LFM
236-150AB	1.500(38.1)	.570 (14.5) x .500 (12.7)	Vert./Horiz.	No Tab	Clip/Mtg Hole	40°C @ 2W	4.80°C/W @ 400 LFM
236-150ABE-01	1.500(38.1)	.570 (14.5) x .500 (12.7)	Vertical	01	Clip/Mtg Hole	40°C @ 2W	4.80°C/W @ 400 LFM
236-150ABE-05	.500(12.7)	1.500 (38.1) x .570 (14.5)	Horizontal	05	Clip/Mtg Hole	40°C @ 2W	4.80°C/W @ 400 LFM
236-150ABE-10	1.625(41.3)	.570 (14.5) x .570 (12.7)	Vertical	10	Clip/Mtg Hole	40°C @ 2W	4.80°C/W @ 400 LFM

Material: Aluminum, Black Anodized

### MECHANICAL DIMENSIONS

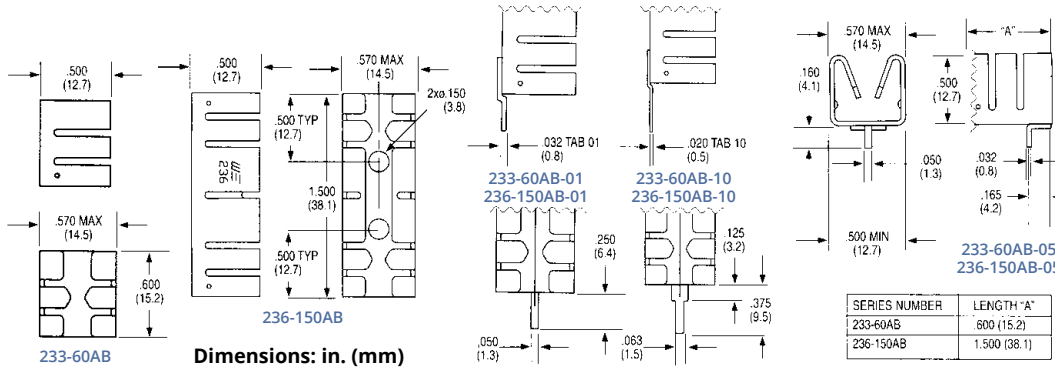

### NATURAL AND FORCED CONVECTION CHARACTERISTICS

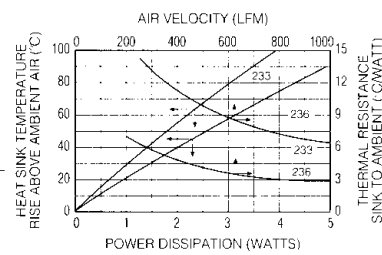

SUGGESTED TAB HOLE =  $\phi$ 0.075 (1.9) (PLATED) WITH  $\phi$ 0.100 (2.5) PAD

COMPACT, STRESS-FREE LABOR-SAVING  
LOCKING-TAB HEAT SINKS

## 275 & 231 SERIES

TO-220

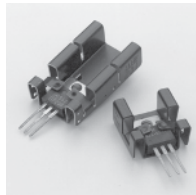

PATENT  
5381041

Standard P/N	Height Above PC Board in. (mm)	Footprint Dimensions in. (mm)	Mounting Configuration	Solderable Tab Options	Mounting Style	Thermal Performance at Typical Load	
						Natural Convection	Forced Convection
275-75AB	.750 (19.1)	.835 (21.2) x .400 (12.7)	Vert./Horiz.	No Tab	Clip/Mtg Hole	44 C @ 2W	7.9°C/W @ 400 LFM
275-75ABE-01	.750 (19.1)	.835 (21.2) x .400 (12.7)	Vertical	01	Clip/Mtg Hole	44°C @ 2W	7.9°C/W @ 400 LFM
275-75ABE-10	.875 (12.7)	.835 (21.2) x .400 (14.5)	Vertical	10	Clip/Mtg Hole	44°C @ 2W	7.9°C/W @ 400 LFM
231-69PAB	.690 (18.4)	.835 (21.2) x .400 (12.7)	Vert./Horiz.	No Tab	Clip/Mtg Hole	45°C @ 2W	8°C/W @ 400 LFM
231-69PABE	.400 (10.1)	.690 (17.5) x .835 (12.7)	Horizontal	13H	Clip/Mtg Hole	45°C @ 2W	8°C/W @ 400 LFM
231-69PABE-XXX	.690 (17.5)	.835 (21.2) x .400 (12.7)	Vertical	13V, 14V, 15V	Clip/Mtg Hole	45°C @ 2W	8°C/W @ 400 LFM
231-75PAB	.750 (19.1)	.835 (21.2) x .400 (14.5)	Vert./Horiz.	No Tab	Clip/Mtg Hole	43°C @ 2W	7.9°C/W @ 400 LFM
231-75PABE	.400 (10.1)	.750 (19.1) x .835 (12.7)	Horizontal	13H	Clip/Mtg Hole	43°C @ 2W	7.9°C/W @ 400 LFM
231-75PABE-XXX	.750 (19.1)	.835 (21.2) x .400 (12.7)	Vertical	13V, 14V, 15V	Clip/Mtg Hole	43°C @ 2W	7.9°C/W @ 400 LFM
231-137PAB	1.375 (35)	.835 (21.2) x .400 (12.7)	Vert./Horiz.	No Tab	Clip/Mtg Hole	32°C @ 2W	5.9°C/W @ 400 LFM
231-137PABE	.400 (10.2)	1.375 (34.9) x .835 (12.7)	Horizontal	13H	Clip/Mtg Hole	32°C @ 2W	5.9°C/W @ 400 LFM
231-137PABE-XXX	1.375 (35)	.835 (21.2) x .400 (12.7)	Vertical	13V, 14V, 15V	Clip/Mtg Hole	32°C @ 2W	5.9°C/W @ 400 LFM

Material: Aluminum, Pre-anodized Black (PAB), Anodized Black (AB)

TO-220

COMPACT, STRESS-FREE LABOR-SAVING  
LOCKING-TAB HEAT SINKS

## 275 & 231 SERIES

### MECHANICAL DIMENSIONS

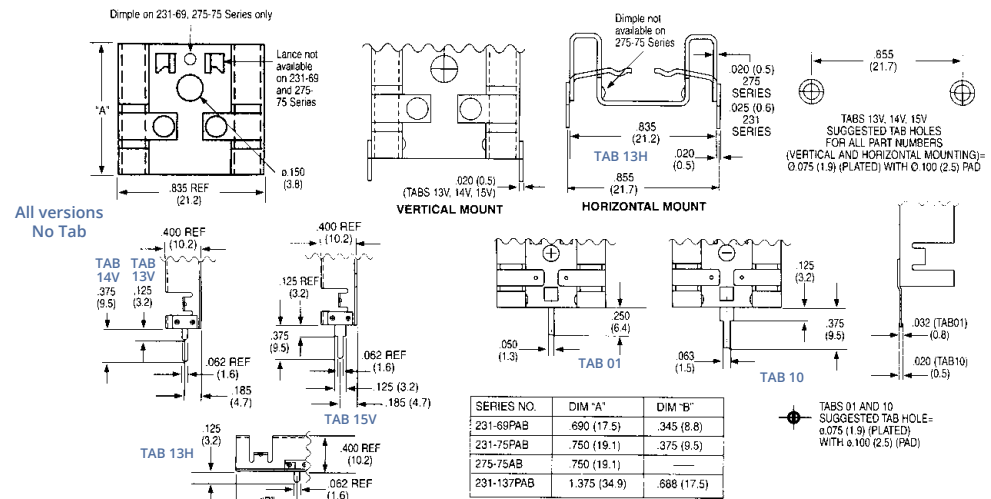

Dimensions: in. (mm)

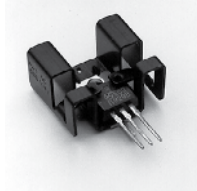

## 235 SERIES

COMPACT, STRESS-FREE LABOR-SAVING  
LOCKING-TAB HEAT SINKS

TO-220

PATENT  
5381041

Standard P/N	Height Above PC Board in. (mm)	Footprint Dimensions in. (mm)	Mounting Configuration	Solderable Tab Options	Mounting Style	Thermal Performance at Typical Load	
						Natural Convection	Forced Convection
235-85AB	.850 (21.6)	1.000 (25.4) x .500 (12.7)	Vert./Horiz.	No Tab	Clip/Mtg Hole	40°C @ 2W	6.8°C/W @ 400 LFM
235-85ABE-01	.850 (21.6)	1.000 (25.4) x .500 (12.7)	Vertical	01	Clip/Mtg Hole	40°C @ 2W	6.8°C/W @ 400 LFM
235-85ABE-05	.500 (12.7)	.850 (21.6) x 1.000 (25.4)	Horizontal	05	Clip/Mtg Hole	40°C @ 2W	6.8°C/W @ 400 LFM
235-85ABE-10	.975 (24.8)	1.000 (25.4) x .500 (12.7)	Vertical	10	Clip/Mtg Hole	40°C @ 2W	6.8°C/W @ 400 LFM

Material: Aluminum, Black Anodized

### MECHANICAL DIMENSIONS

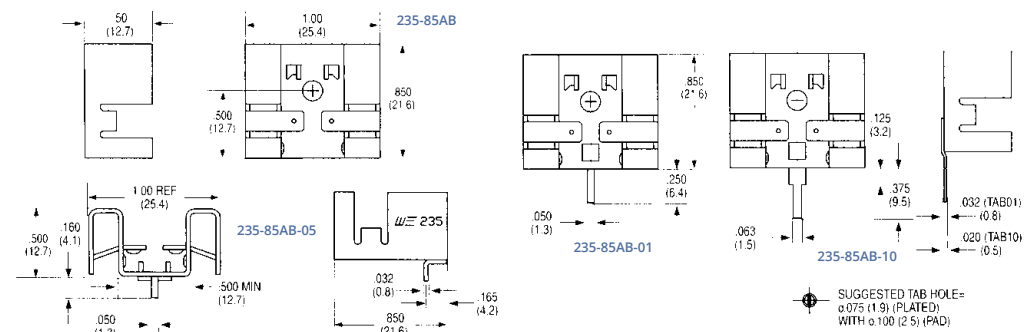

Dimensions: in. (mm)

### NATURAL AND FORCED CONVECTION CHARACTERISTICS

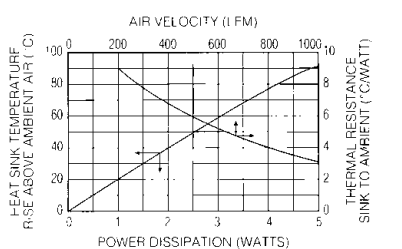

SUGGESTED TAB HOLE =  $\phi$ 0.075 (1.9) (PLATED) WITH  $\phi$ 0.100 (2.5) PAD

# BOARD LEVEL POWER SEMICONDUCTOR HEAT SINKS

## 243 SERIES

LABOR-SAVING CLIP-ON HEAT SINKS

TO-220

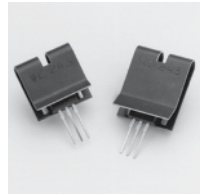

Standard P/N	Height Above PC Board in. (mm)	Footprint Dimensions in. (mm)	Mounting Configuration	Solderable Tab Options	Mounting Style	Thermal Performance at Typical Load	
						Natural Convection	Forced Convection
243-1PAB	1.000 (25.4)	.800 (20.3) x .270 (6.9)	Vert./Horiz.	No Tab	Clip	50°C@ 2W	4.5°C/W @ 400 LFM
243-3PAB	.800 (20.3)	.800 (20.3) x .270 (6.9)	Verl./Horiz.	No Tab	Clip	78°C@ 2W	8.2°C/W @ 400 LFM

**Material:** Aluminum, Pre-anodized Black

### MECHANICAL DIMENSIONS

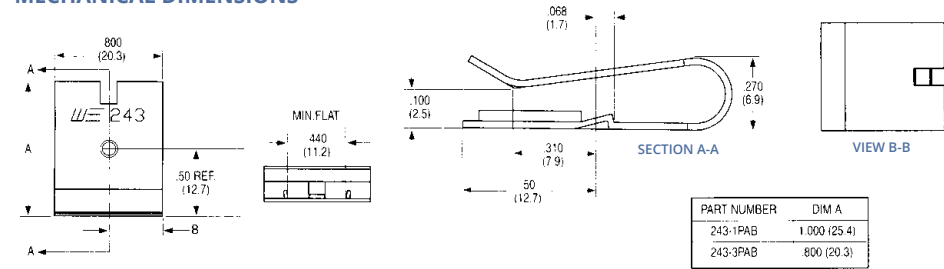

### NATURAL AND FORCED CONVECTION CHARACTERISTICS

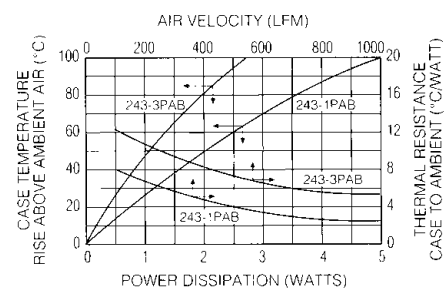

TO-220

VERTICAL MOUNT HEAT SINK

## 265 SERIES

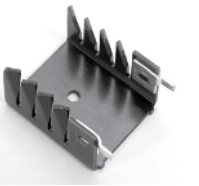

Standard P/N	Height Above PC Board in. (mm)	Maximum Footprint in. (mm)	Thermal Performance at Typical Load	
			Natural Convection	Forced Convection
265-118ABHE-22	1.18 (30.0)	1.00 (25.4) x .50 (12.7)	56°C rise @ 4W	7.0°C/W @ 200LFM

**Material:** Aluminum, Black Anodized

### MECHANICAL DIMENSIONS

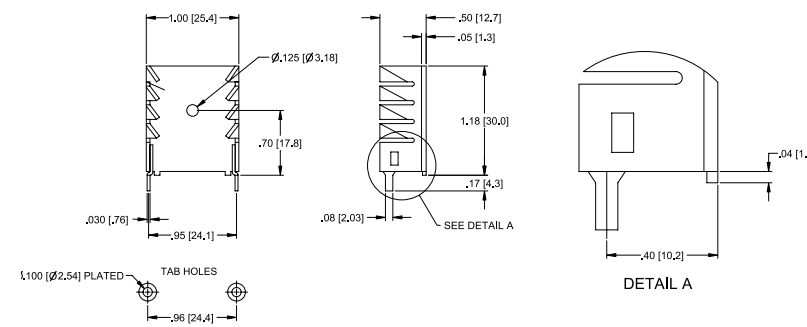

### NATURAL AND FORCED CONVECTION CHARACTERISTICS

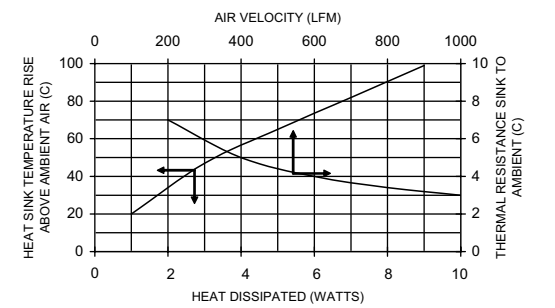

TO-220

SNAP-DOWN SELF-LOCKING HEAT SINKS

## 239 SERIES



PATENT PENDING

Standard P/N	Height Above PC Board in. (mm)	Footprint Dimensions in. (mm)	Mounting Configuration	Solderable Tab Options	Mounting Style	Thermal Performance at Typical Load	
						Natural Convection	Forced Convection
239-75AB	.750 (19.1)	1.120 (28.4) x .435 (11.0)	Vert./Horiz.	No Tab	Clip/Mtg Hole	38°C @ 2W	6°C/W @ 400 LFM
239-75ABE-03	.750 (19.1)	1.120 (28.4) x .435 (11.0)	Vertical	03	Clip/Mtg Hole	38°C @ 2W	6°C/W @ 400 LFM
239-75ABE-04	.750 (19.1)	1.120 (28.4) x .435 (11.0)	Vertical	04	Clip/Mtg Hole	38°C @ 2W	6°C/W @ 400 LFM

**Material:** Aluminum, Black Anodized

### MECHANICAL DIMENSIONS

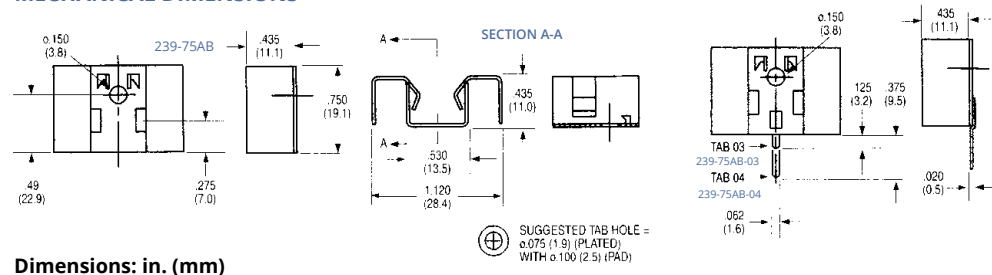

### NATURAL AND FORCED CONVECTION CHARACTERISTICS

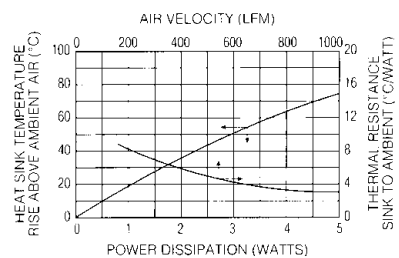

## 286DB SERIES

VERTICAL MOUNT HEAT SINK

TO-220

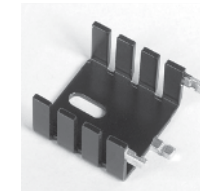

Standard P/N	Height Above PC Board in. (mm)	Maximum Footprint in. (mm)	Thermal Performance at Typical Load	
			Natural Convection	Forced Convection
286DBE	.95 (24.1)	1.00 (25.4) x .50 (12.7)	65°C rise @ 4W	9.0°C/W @ 200LFM

**Material:** Aluminum, Black Anodized

### MECHANICAL DIMENSIONS

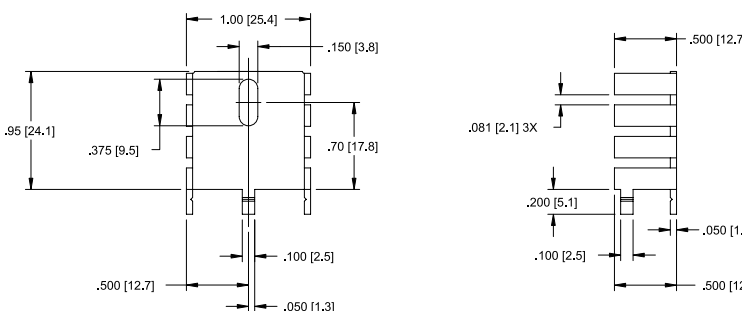

### NATURAL AND FORCED CONVECTION CHARACTERISTICS

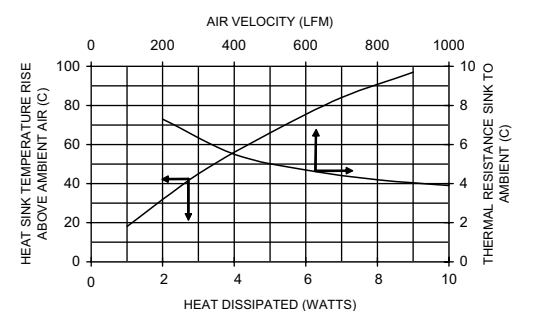

# BOARD LEVEL POWER SEMICONDUCTOR HEAT SINKS

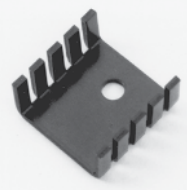

## 273 SERIES

LOW-COST, LOW-HEIGHT WAVE-SOLDERABLE HEAT SINKS

TO-220 and TO-218

Standard P/N	Height Above PC Board in. (mm)	Footprint Dimensions in. (mm)	Mounting Configuration	Solderable Tab Options	Mounting Style	Thermal Performance at Typical Load	
						Natural Convection	Forced Convection
273-AB	.375 (9.5)	.750 (19.1) x .750 (19.1)	Vert./Horiz.	No Tab	Mtg Hole	49°C @ 2W	7.2°C/W @ 400 LFM
273-ABE-01	.375 (9.5)	.750 (19.1) x .750 (19.1)	Vertical	01	Mtg Hole	49°C @ 2W	7.2°C/W @ 400 LFM
273-ABE-02	.375 (9.5)	.750 (19.1) x .750 (19.1)	Vertical	02	Mtg Hole	49°C @ 2W	7.2°C/W @ 400 LFM

Material: Aluminum, Black Anodized

### MECHANICAL DIMENSIONS

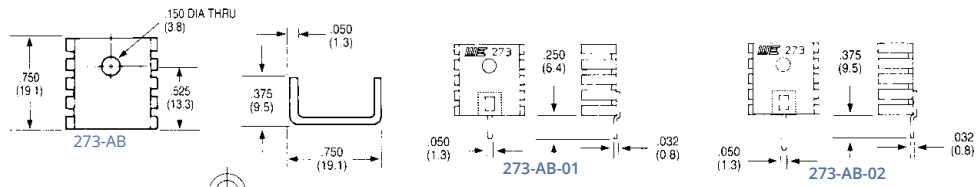

Note:  
1. Suggested Tab Hole =  $\phi$ .075 (1.9) (Plated) with  $\phi$ .100 (2.5) pad

Dimensions: in. (mm)

### NATURAL AND FORCED CONVECTION CHARACTERISTICS

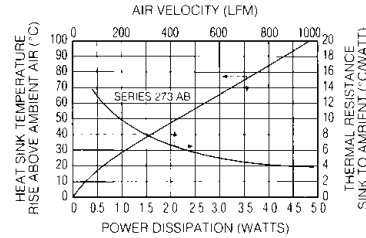

## LOW-COST, LOW-HEIGHT WAVE-SOLDERABLE HEAT SINKS

## 274 & 281 SERIES

TO-220

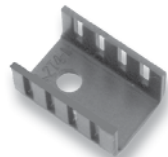

Standard P/N	Height Above PC Board in. (mm)	Footprint Dimensions in. (mm)	Mounting Configuration	Solderable Tab Options	Mounting Style	Thermal Performance at Typical Load	
						Natural Convection	Forced Convection
274-1AB	.375 (9.5)	.520 (13.2) x .750 (19.1)	Vert./Horiz.	No Tab	Mtg Hole	56°C @ 2W	8.0°C/W @ 400 LFM
274-1ABE-01	.375 (9.5)	.520 (13.2) x .750 (19.1)	Vertical	01	Mtg Hole	56°C @ 2W	8.0°C/W @ 400 LFM
274-1ABE-02	.375 (9.5)	.520 (13.2) x .750 (19.1)	Vertical	02	Mtg Hole	56°C @ 2W	8.0°C/W @ 400 LFM
274-2AB	.500 (12.7)	.520 (13.2) x .750 (19.1)	Vert./Horiz.	No Tab	Mtg Hole	50°C @ 2W	7.0°C/W @ 400 LFM
274-2ABE-01	.500 (12.7)	.520 (13.2) x .750 (19.1)	Vertical	01	Mtg Hole	50°C @ 2W	7.0°C/W @ 400 LFM
274-2ABE-02	.500 (12.7)	.520 (13.2) x .750 (19.1)	Vertical	02	Mtg Hole	50°C @ 2W	7.0°C/W @ 400 LFM
274-3AB	.250 (6.4)	.520 (13.2) x .750 (19.1)	Vert./Horiz.	No Tab	Mtg Hole	62°C @ 2W	9.0°C/W @ 400 LFM
274-3ABE-01	.250 (6.4)	.520 (13.2) x .750 (19.1)	Vertical	01	Mtg Hole	62°C @ 2W	9.0°C/W @ 400 LFM
274-3ABE-02	.250 (6.4)	.520 (13.2) x .750 (19.1)	Vertical	02	Mtg Hole	62°C @ 2W	9.0°C/W @ 400 LFM
281-1AB	.375 (9.5)	.520 (13.2) x .750 (19.1)	Vertical	No Tab	Mtg Hole	56°C @ 2W	8.0°C/W @ 400 LFM
281-2AB	.500 (12.7)	.520 (13.2) x .750 (19.1)	Vertical	No Tab	Mtg Hole	50°C @ 2W	7.0°C/W @ 400 LFM

Material: Aluminum, Black Anodized

### MECHANICAL DIMENSIONS

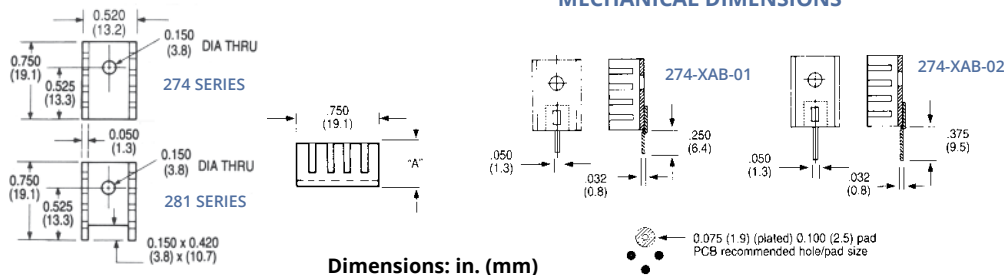

Dimensions: in. (mm)

$\phi$ .075 (1.9) (plated)  $\phi$ .100 (2.5) pad  
PCB recommended hole/pad size

### NATURAL AND FORCED CONVECTION CHARACTERISTICS

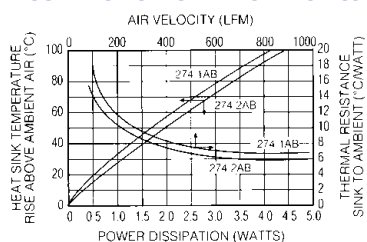

TO-220

## LABOR-SAVING TWISTED FIN HEAT SINKS

## 240 SERIES

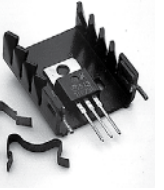

Standard P/N	Height Above PC Board in. (mm)	Footprint Dimensions in. (mm)	Mounting Configuration	Solderable Tab Options	Mounting Style	Thermal Performance at Typical Load	
						Natural Convection	Forced Convection
240-118ABEH-22	1.180 (30.0)	1.000 (25.4) x .500 (12.7)	Vertical	22	Clip/Mtg Hole	55°C @ 4W	5.3°C/W @ 400 LFM
240-118ABES-22	1.180 (30.0)	1.000 (25.4) x .500 (12.7)	Vertical	22	Clip/Mtg Slot	55°C @ 4W	5.3°C/W @ 400 LFM

Material: Aluminum, Black Anodized

### MECHANICAL DIMENSIONS

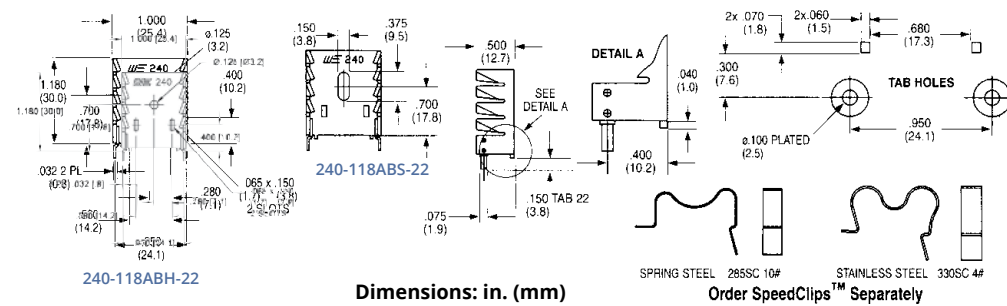

Dimensions: in. (mm)

Order SpeedClips™ Separately

### NATURAL AND FORCED CONVECTION CHARACTERISTICS

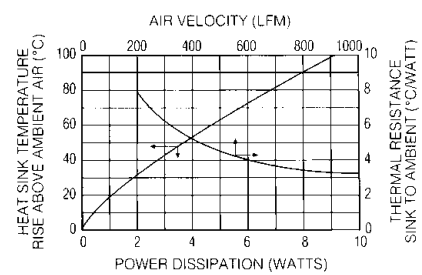

## 242 SERIES

## LOW-COST, LOW-HEIGHT WAVE-SOLDERABLE HEAT SINKS

TO-220

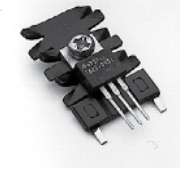

Standard P/N	Height Above PC Board in. (mm)	Footprint Dimensions in. (mm)	Mounting Configuration	Solderable Tab Options	Mounting Style	Thermal Performance at Typical Load	
						Natural Convection	Forced Convection
242-125ABE-22	1.285 (32.6)	.875 (22.2) x .250 (6.4)	Vertical	22	Mtg Hole	48°C @ 2W	6.2°C/W @ 400 LFM

Material: Aluminum, Black Anodized

### MECHANICAL DIMENSIONS

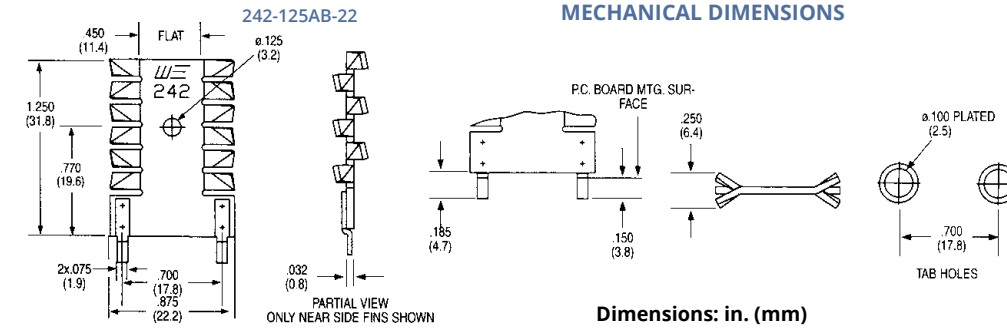

Dimensions: in. (mm)

### NATURAL AND FORCED CONVECTION CHARACTERISTICS

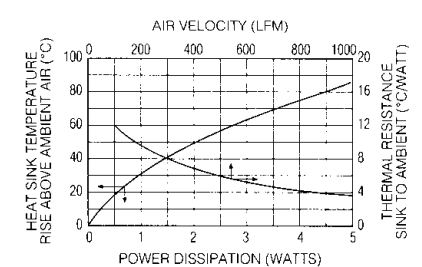



## BOARD LEVEL POWER SEMICONDUCTOR HEAT SINKS

## BOARD LEVEL HEAT SINKS FOR TO-220, TO-218 & MULTIWATT™ COMPONENTS

### 232 & 238 SERIES

STAGGERED FIN HEAT SINKS FOR VERTICAL MOUNTING

TO-220 and TO-202

Standard P/N	Height Above PC Board in. (mm)	Footprint Dimensions in. (mm)	Mounting Configuration	Solderable Tab Options	Mounting Style	Thermal Performance at Typical Load	
						Natural Convection	Forced Convection
232-200AB	2.000 (50.8)	1.380 (35.1) x .500 (12.7)	Vertical	2, Twisted	Clip/Mtg Hole	48°C @ 4W	3.3°C/W @ 400 LFM
232-200ABE-23	2.000 (50.8)	1.380 (35.1) x .500 (12.7)	Vertical	2, Solderable	Clip/Mtg Hole	48°C @ 4W	3.3°C/W @ 400 LFM
238-200AB	2.000 (50.8)	1.380 (35.1) x .500 (12.7)	Vertical	2, Twisted	Mtg Slot	48°C @ 4W	3.3°C/W @ 400 LFM
238-200ABE-23	2.000 (50.8)	1.380 (35.1) x .500 (12.7)	Vertical	2, Solderable	Mtg Slot	48°C @ 4W	3.3°C/W @ 400 LFM

Material: Aluminum, Black Anodized

#### MECHANICAL DIMENSIONS

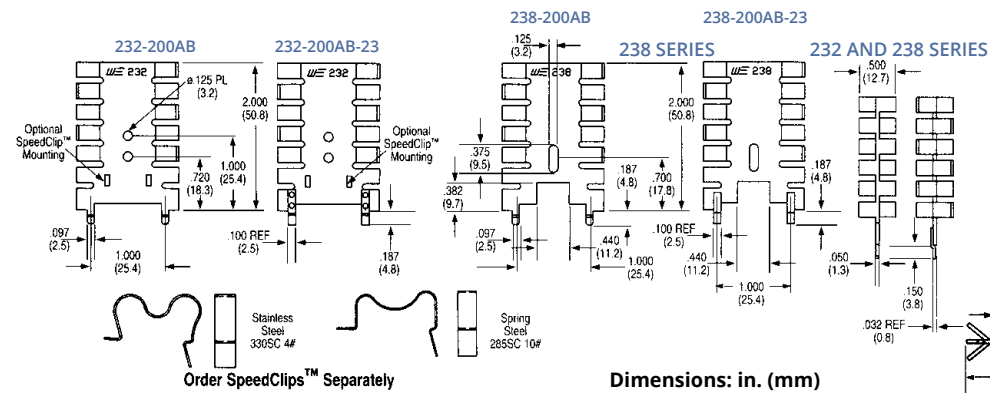

#### NATURAL AND FORCED CONVECTION CHARACTERISTICS

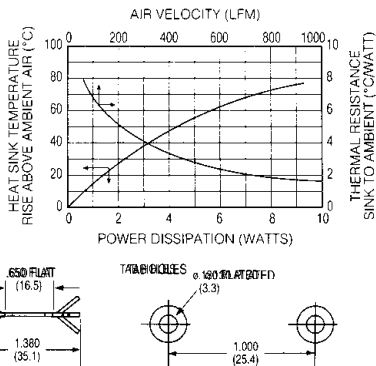

Multiwatt

LOW HEIGHT, SLIM PROFILE WAVE-SOLDERABLE FOLDED FIN HEAT SINKS

### 244 SERIES

Standard P/N	Height Above PC Board in. (mm)	Footprint Dimensions in. (mm)	Mounting Configuration	Solderable Tab Options	Thermal Performance at Typical Load		Weight lbs. (grams)
					Natural Convection	Force Convection	
244-145AB	1.450 (36.8)	1.300 (33.0) x 480 (12.1)	Vert/Horiz, Vertical	No Tab	44°C @ 4W	4.4°C/W @ 400 LFM	.0160 (7.25)
244-145ABE-50	1.650 (41.9)	1.300 (33.0) x 480 (12.1)	Vertical	50	44°C @ 4W	4.4°C/W @ 400 LFM	.0170 (7.20)

Material: Aluminum, Black Anodized

#### MECHANICAL DIMENSIONS

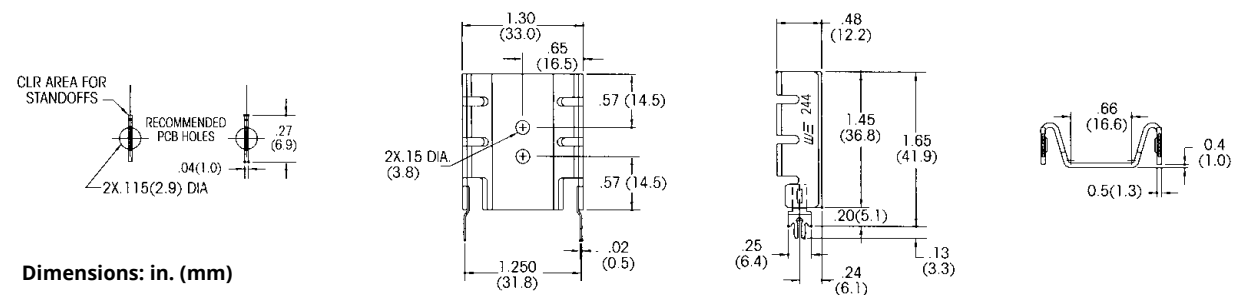

Dimensions: in. (mm)

15 Lead Multiwatt

SLIM-PROFILE HEAT SINKS WITH INTEGRAL CLIPS

### 251 SERIES

Standard P/N	Height Above PC Board in. (mm)	Footprint Dimensions in. (mm)	Mounting Configuration	Solderable Tab Options	Mounting Style	Thermal Performance at Typical Load	
						Natural Convection	Forced Convection
251-62AB	.620 (15.7)	.910 (23.1) x .380 (9.7)	Vert./Horiz.	No Tab	Clip	66°C @ 3W	66°C/W @ 400 LFM
251-80AB	.845 (21.5)	.910 (23.1) x .380 (9.7)	Vert./Horiz.	No Tab	Clip	64°C @ 3W	66°C/W @ 400 LFM
251-80ABE-19	.875 (22.2)	.910 (23.1) x .380 (9.7)	Vertical	19	Clip	64°C @ 3W	66°C/W @ 400 LFM

Material: Aluminum, Black Anodized

#### MECHANICAL DIMENSIONS

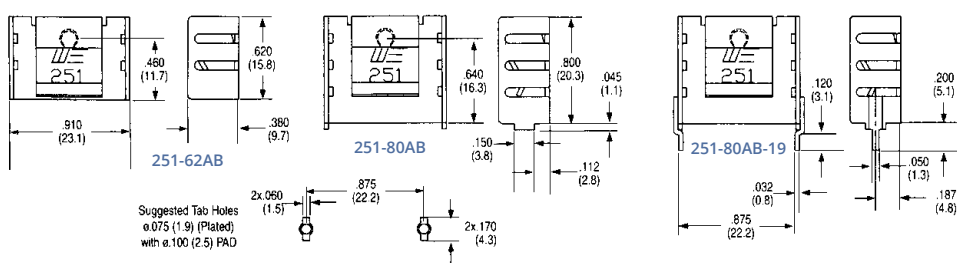

Dimensions: in. (mm)

#### NATURAL AND FORCED CONVECTION CHARACTERISTICS

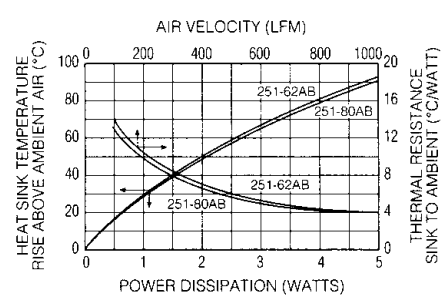

### 245 SERIES

LOW HEIGHT, SLIM PROFILE WAVE-SOLDERABLE FOLDED FIN HEAT SINKS

Multiwatt

Standard P/N	Height Above PC Board in. (mm)	Footprint Dimensions in. (mm)	Mounting Configuration	Solderable Tab Options	Thermal Performance at Typical Load		Weight lbs. (grams)
					Natural Convection	Forced Convection	
245-145AB	1.450 (36.8)	1.750 (44.5) x .380 (9.7)	Vert./Horiz.	No Tab	38°C @ 4W	3.2°C/W @ 400 LFM	.0160 (7.25)
245-145ABE-50	1.650 (41.9)	1.750 (44.5) x .380 (9.7)	Vertical	50	38°C @ 4W	3.2°C/W @ 400 LFM	.0170 (7.20)

Material: Aluminum, Black Anodized

#### MECHANICAL DIMENSIONS

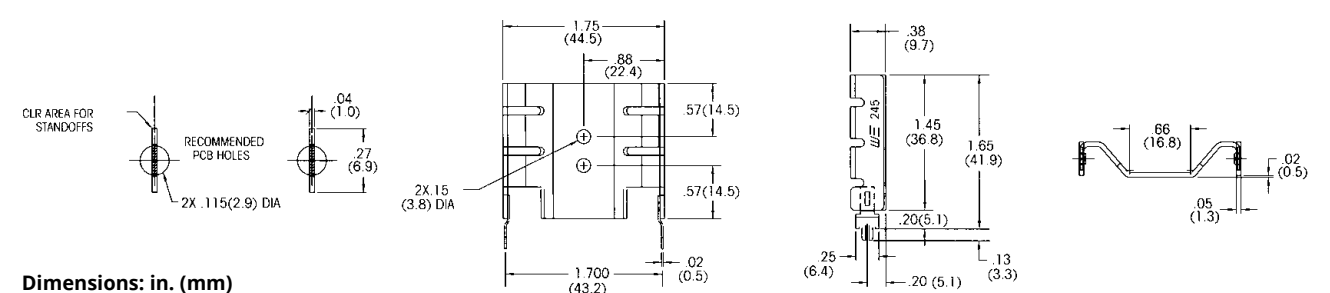

Dimensions: in. (mm)

## BOARD LEVEL HEAT SINKS FOR TO-220, TO-218 & MULTIWATT™ COMPONENTS



### 246 SERIES

MEDIUM HEIGHT, SLIM PROFILE WAVE-SOLDERABLE FOLDED FIN HEAT SINKS

Multiwatt

Standard P/N	Height Above PC Board in. (mm)	Footprint Dimensions in. (mm)	Mounting Configuration	Solderable Tab Options	Thermal Performance at Typical Load		Weight lbs. (grams)
					Natural Convection	Forced Convection	
246-197AB	1.968 (50.0)	1.986 (50.4) x 3.75 (9.5)	Vert./Horiz.	No Tab	35°C @ 4W	2.8°C/W @ 400 LFM	.0240 (10.90)
246-197ABE-50	2.168 (55.1)	1.986 (50.4) x 3.75 (9.5)	Vertical	50	35°C @ 4W	2.8°C/W @ 400 LFM	.0250 (11.40)

Order SpeedClip™ 285SC or 330SC separately. (See 248 Series section).

Material: Aluminum, Black Anodized

#### MECHANICAL DIMENSIONS

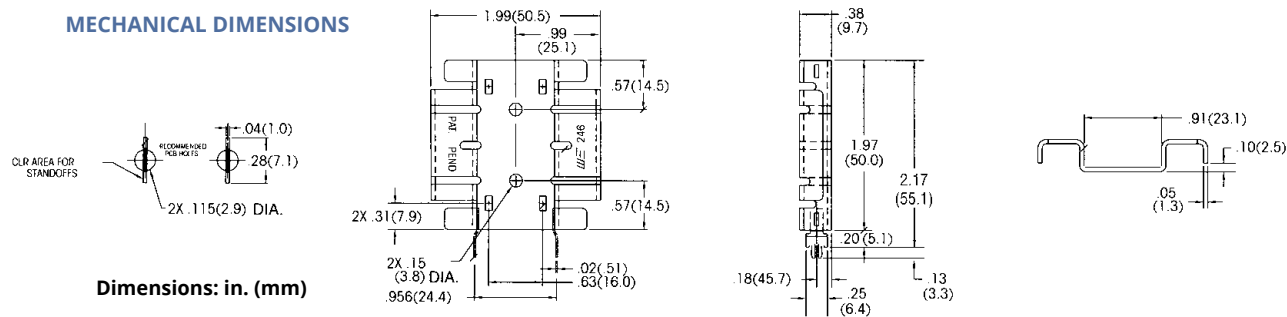

LOW HEIGHT, MEDIUM PROFILE WAVE-SOLDERABLE FOLDED FIN HEAT SINKS

Multiwatt

### 248 SERIES

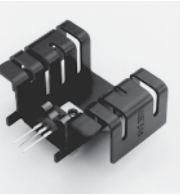

Standard P/N	Height Above PC Board in. (mm)	Footprint Dimensions in. (mm)	Mounting Configuration	Solderable Tab Options	Thermal Performance at Typical Load		Weight lbs. (grams)
					Natural Convection	Forced Convection	
248-162AB	1.620 (41.1)	2.000 (50.8) x .750 (19.1)	Vert./Horiz.	No Tab	35°C @ 4W	2.5°C/W @ 400 LFM	.026 (11.60)
248-162ABE-50	1.620 (41.1)	2.000 (50.8) x .750 (19.1)	Vertical	50	35°C @ 4W	2.5°C/W @ 400 LFM	.027 (12.20)

Order SpeedClip™ 285SC or 330SC separately.

Material: Aluminum, Black Anodized

#### MECHANICAL DIMENSIONS

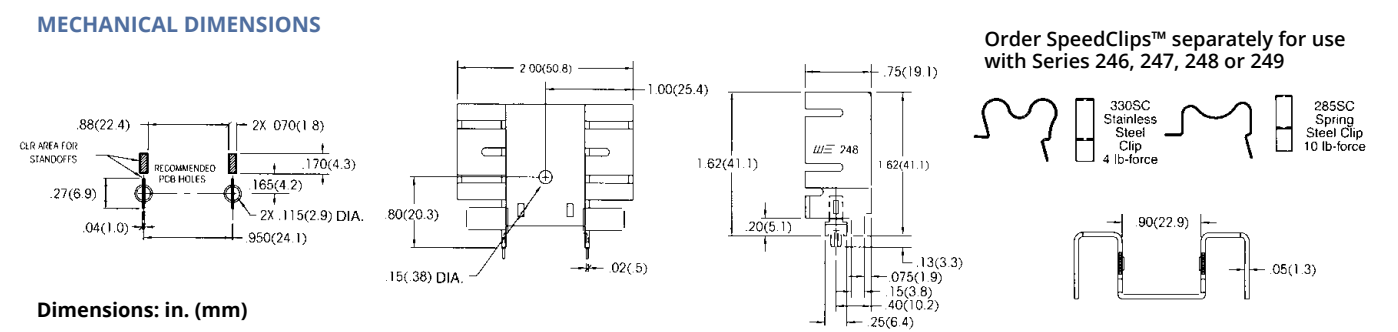

MEDIUM HEIGHT, DEEP PROFILE WAVE-SOLDERABLE FOLDED FIN HEAT SINKS

Multiwatt

### 247 SERIES

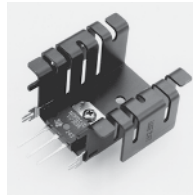

Standard P/N	Height Above PC Board in. (mm)	Footprint Dimensions in. (mm)	Mounting Configuration	Solderable Tab Options	Thermal Performance at Typical Load		Weight lbs. (grams)
					Natural Convection	Forced Convection	
247-195AB	1.950 (49.5)	1.900 (48.3) x .950 (24.1)	Vert./Horiz.	No Tab	25°C @ 4W	2.4°C/W @ 400 LFM	.0330 (15.10)
247-195ABE-50	1.950 (49.5)	1.900 (48.3) x .950 (24.1)	Vertical	50	25°C @ 4W	2.4°C/W @ 400 LFM	.0340 (15.60)

Order SpeedClip™ 285SC or 330SC separately. (See 248 Series section).

Material: Aluminum, Black Anodized

#### MECHANICAL DIMENSIONS

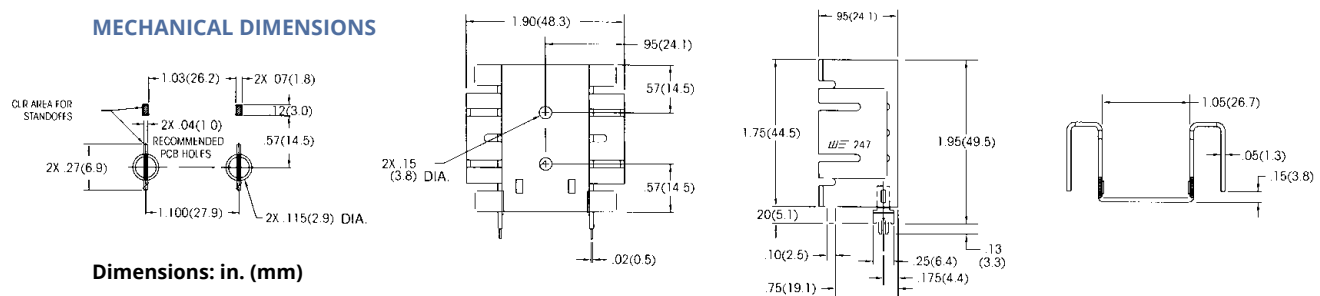

MEDIUM HEIGHT, DEEP PROFILE WAVE-SOLDERABLE FOLDED FIN HEAT SINKS

### 249 SERIES

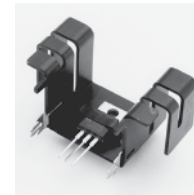

Multiwatt

Standard P/N	Height Above PC Board in. (mm)	Footprint Dimensions in. (mm)	Mounting Configuration	Solderable Tab Options	Thermal Performance at Typical Load		Weight lbs. (grams)
					Natural Convection	Forced Convection	
249-113AB	1.130 (28.7)	1.900 (48.3) x .950 (24.1)	Vert./Horiz.	No Tab	35°C @ 4W	3.29°C/W @ 400 LFM	.020 (8.90)
249-113ABE-50	1.130 (28.7)	1.900 (48.3) x .950 (24.1)	Vertical	50	35°C @ 4W	3.29°C/W @ 400 LFM	.021 (9.40)

Order SpeedClip™ 285SC or 330SC separately. (See 248 Series section).

Material: Aluminum, Black Anodized

#### MECHANICAL DIMENSIONS

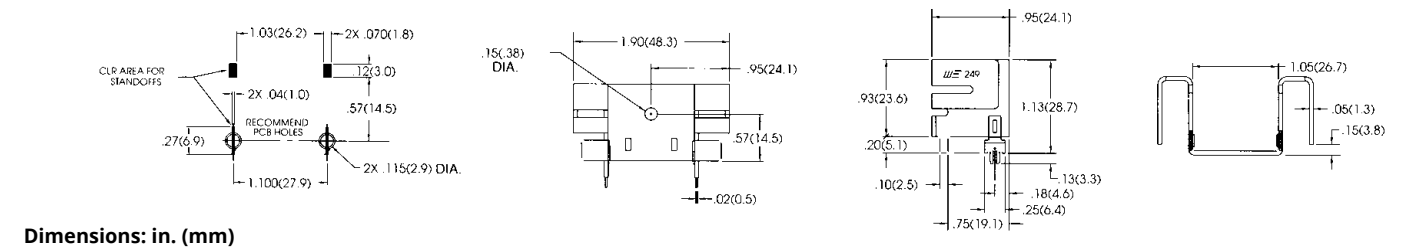

# BOARD LEVEL POWER SEMICONDUCTOR HEAT SINKS



## 288 SERIES

COMPACT WAVE-SOLDERABLE LOW-COST HEAT SINKS

TO-220 and TO-202

Mounting tabs are pre-tinned to ensure excellent wave-solder bond and good electrical connections for vertical mounting of TO-220 and TO-202 semiconductor packages. These heat sinks are designed for use where minimum PC board space is available. The 288-1AB is a stamped aluminum heat sink, black anodized, designed for applications requiring good heat dissipation from a heat sink occupying minimum space, available at minimum cost.

Standard P/N	Height Above PC Board in. (mm)	Maximum Footprint in. (mm)	Thermal Performance at Typical Load		Weight lbs. (grams)
			Natural Convection	Forced Convection	
288-1ABE	1.250 (31.8)	0.875 (22.2) x 0.215 (5.5)	85°C @ 4W	12°C/W @ 200 LFM	0.0057 (2.59)

### MECHANICAL DIMENSIONS

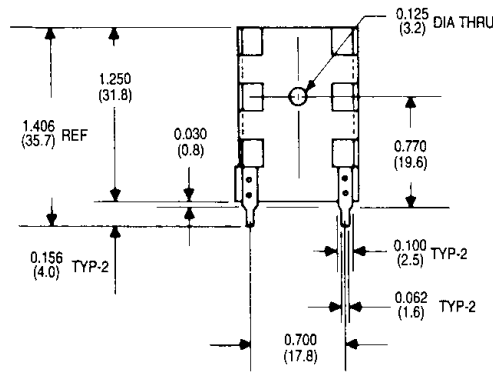

Dimensions: in. (mm)

### NATURAL AND FORCED CONVECTION CHARACTERISTICS

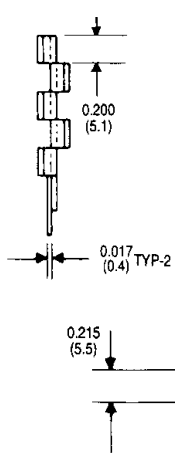
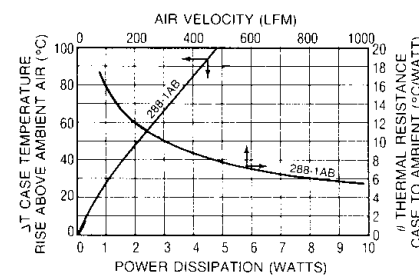

TOP-MOUNT BOOSTER HEAT SINKS FOR USE WITH 270/272/280 SERIES

## 271 SERIES

TO-220

### MECHANICAL DIMENSIONS

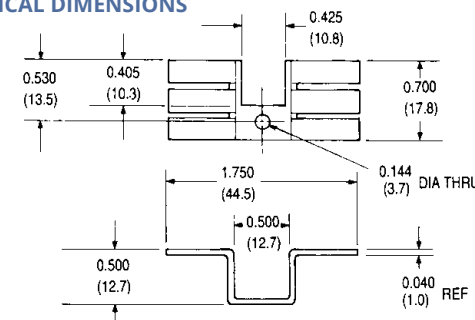

Dimensions: in. (mm)

### NATURAL AND FORCED CONVECTION CHARACTERISTICS

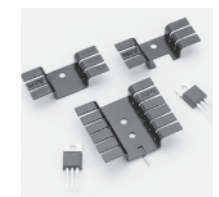
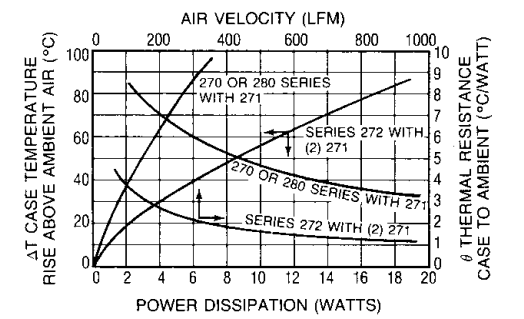

## 270, 272, & 280 SERIES

SMALL FOOTPRINT LOW-COST HEAT SINKS

TO-220 and TO-202

These exceptionally low-cost heat sinks can be mounted horizontally under a TO-220 or TO-202 case style with a maximum height of only 0.375 in. (9.4). For added performance, a 271 Series heat sink can also be used for double-sided heat dissipation. The 270-AB and 280-AB accept one power semiconductor; the 272-AB is designed for two power semiconductors. Specify solderable tab options for the **272 Series** by the addition of suffix "01" or "02" to the standard part number (i.e. 272-AB01 or 272-AB02).

Standard P/N	Height Above PC Board in. (mm)	Horizontal Mounting Maximum Footing in. (mm)	Solderable Tab Options	Thermal Performance at Typical Load		Weight lbs. (grams)
				Natural Convection	Forced Convection	
270-AB	0.375 (9.4)	1.750 (44.5) x 0.700 (17.8)	—	70°C @ 4W	6.0°C/W @ 400 LFM	0.0052 (2.36)
272-AB	0.375 (9.4)	1.750 (44.5) x 1.450 (36.8)	01,02	42°C @ 4W	3.6°C/W @ 400 LFM	0.0105 (5.72)
280-AB	0.375 (9.4)	1.750 (44.5) x 0.700 (17.8)	—	70°C @ 4W	6.0°C/W @ 400 LFM	0.0048 (2.18)

**Material:** Aluminum, Black Anodized

TOP-MOUNT BOOSTER HEAT SINKS FOR USE WITH 270/272/280 SERIES

## 271 SERIES

TO-220

This top-hat style booster heat sink can be added to any of the 270, 272, or 280 Series for improved performance. NOTE A: Thermal resistance with one 271-AB. NOTE B: Thermal resistance (total) as shown with (2) 271-AB types added to (1) 272-AB type.



Standard P/N	Height Above Semiconductor Case in. (mm)	Horizontal Mounting Footprint Dimensions in. (mm)	Thermal Performance at Typical Load		Weight lbs. (grams)
			Natural Convection	Forced Convection	
271-AB	0.500 (12.7)	1.750 (44.5) x 0.700 (17.8)	62°C @ 4W (NOTE A) 31°C @ 4W (NOTE B)	5.1°C/W @ 400 LFM 1.8°C/W 400 LFM (NOTE B)	0.0052 (2.36)

**Material:** Aluminum, Black Anodized

### MECHANICAL DIMENSIONS

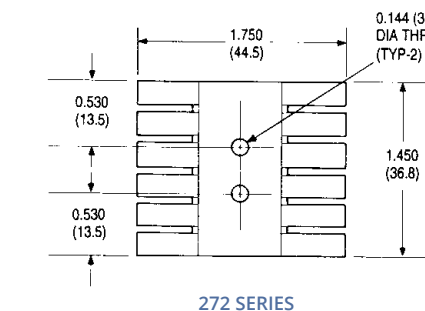
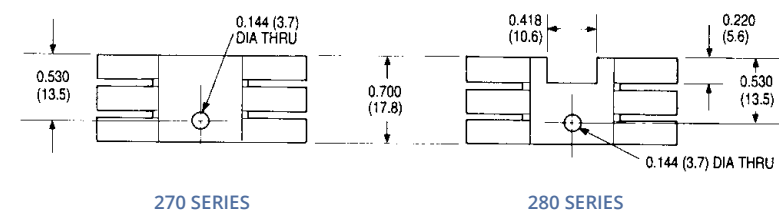

Dimensions: in. (mm)

### NATURAL AND FORCED CONVECTION CHARACTERISTICS

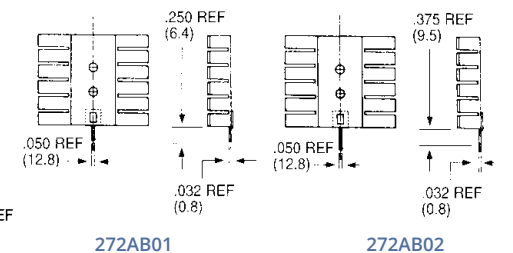
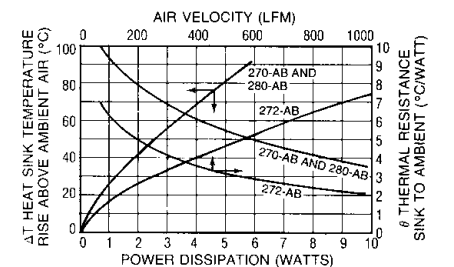

Note:  
1. Suggested Tab Hole = 0.075 ±0.003 plated with 0.100 pad



## BOARD LEVEL POWER SEMICONDUCTOR HEAT SINKS

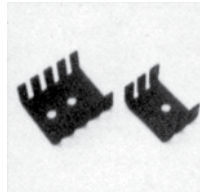

### 289 & 290 SERIES

LOW-COST SINGLE OR DUAL PACKAGE  
HEAT SINKS

TO-218; TO-202; TO-220

Low in cost and compact in overall dimensions, one **289 Series** heat sink can accommodate one semiconductor; the **289 Series** is available with a black anodized finish (289-AB) or with no finish (289-AP). Two semiconductors can be mounted to the 290-2AB style.

Standard P/N	Height Above PC Board in. (mm)	Horizontal Mounting Maximum Footing in. (mm)	Thermal Performance at Typical Load		Weight lbs. (grams)
			Natural Convection	Forced Convection	
289-AB	0.500 (12.7)	1.000 (25.4) x 0.710 (18.1)	50°C @ 2W	9.0 C/W @ 400 LFM	0.0055 (2.49)
289-AP	0.500 (12.7)	1.000 (25.4) x 0.710 (18.1)	50°C @ 2W	9.0 C/W @ 400 LFM	0.0055 (2.49)
290-1AB	0.500 (12.7)	1.000 (25.4) x 1.180 (30.0)	44°C @ 2W	7.0 C/W @ 400 LFM	0.0082 (3.72)
290-2AB	0.500 (12.7)	1.000 (25.4) x 1.180 (30.0)	44°C @ 2W	7.0 C/W @ 400 LFM	0.0081 (3.67)

**Material:** Aluminum, Black Anodized

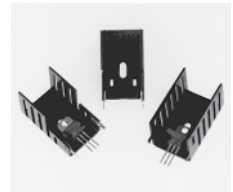
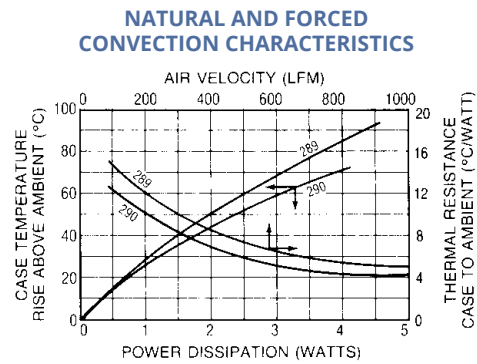
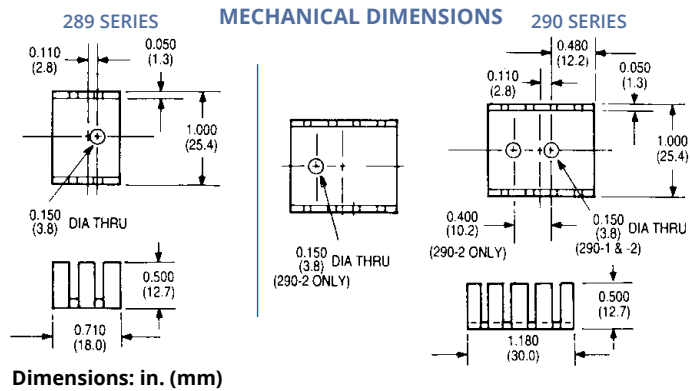

HIGH-PERFORMANCE, HIGH-POWER VERTICAL  
MOUNT HEAT SINKS

### 237 & 252 SERIES

TO-220

Standard P/N	Height Above PC Board in. (mm)	Footprint Dimensions in. (mm)	Mounting Configuration	Solderable Tab Options	Mounting Style	Thermal Performance at Typical Load	
						Natural Convection	Forced Convection
237-167AB2	1.675 (42.5)	1.000 (25.4) x 1.000 (25.4)	Vertical	2, Twisted	Clip/Mtg	Slot46°C @ 4W	4.5°C/W @ 200 LFM
237-167AB3	1.675 (42.5)	1.000 (25.4) x 1.000 (25.4)	Vertical	3, Twisted	Clip/Mtg	Slot46°C @ 4W	4.5°C/W @ 200 LFM
237-167ABE2-24	1.675 (42.5)	1.000 (25.4) x 1.000 (25.4)	Vertical	2, Solderable	Clip/Mtg	Slot46°C @ 4W	4.5°C/W @ 200 LFM
252-167AB2	1.675 (42.5)	1.000 (25.4) x 1.000 (25.4)	Vertical	2, Twisted	Clip/Mtg	Slot40°C @ 4W	4.5°C/W @ 200 LFM
252-167AB3	1.675 (42.5)	1.000 (25.4) x 1.000 (25.4)	Vertical	3, Twisted	Clip/Mtg	Slot40°C @ 4W	4.5°C/W @ 200 LFM
252-167ABE2-24	1.675 (42.5)	1.000 (25.4) x 1.000 (25.4)	Vertical	2, Solderable	Clip/Mtg	Slot40°C @ 4W	4.5°C/W @ 200 LFM

Order SpeedClips™ 2855C or 3305C separately for rapid component installation, lowering manufacturing costs.

**Material:** Aluminum, Black Anodized

#### MECHANICAL DIMENSIONS

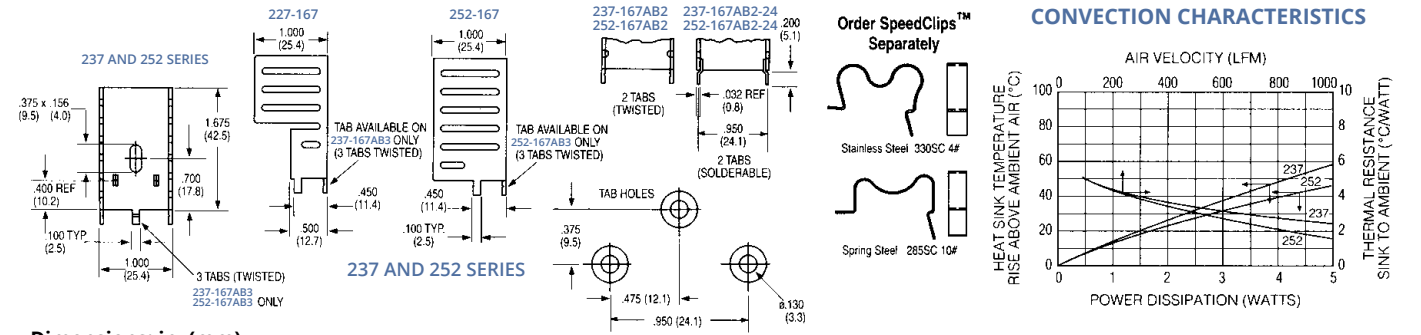

**Dimensions: in. (mm)**

HIGH-PERFORMANCE SLIM PROFILE HEAT SINKS  
WITH INTEGRAL CLIPS

Multiwatt

### 250 SERIES

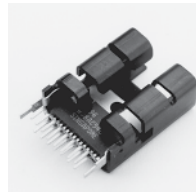

Standard P/N	Height Above PC Board in. (mm)	Footprint Dimensions in. (mm)	Mounting Configuration	Solderable Tab Options	Mounting Style	Thermal Performance at Typical Load	
						Natural Convection	Forced Convection
250-122AB	1.220 (31.0)	1.000 (25.4) x .500 (12.7)	Vert./Horiz.	No Tab	Clip	50°C @ 4W	3.7°C/W @ 400 LFM
250-122ABE-09	1.220 (31.0)	1.000 (25.4) x .500 (12.7)	Vertical	09	Clip	50°C @ 4W	3.7°C/W @ 400 LFM
250-122ABE-25	1.380 (35.1)	1.000 (25.4) x .500 (12.7)	Vertical	25	Clip	50°C @ 4W	3.7°C/W @ 400 LFM

**Material:** Aluminum, Black Anodized

#### MECHANICAL DIMENSIONS

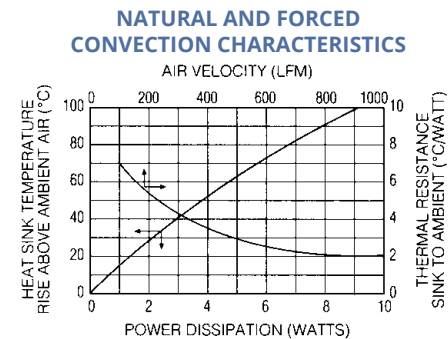
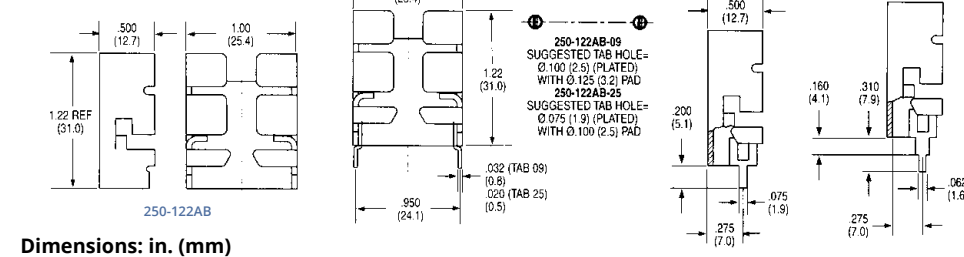

### 291 SERIES

LABOR-SAVING CLIP-ON HEAT SINKS

TO-220



Designed for mounting horizontally or vertically on a circuit board, **291 Series** heat sinks employ a unique clip for attachment of TO-220 case styles. One type is available with a locking clip and one with a 0.140 in. (3.6) diameter mounting hole only.

Standard P/N	Vertical Height Above PC Board in. (mm)	Mounting Footprint Dimensions in. (mm)	Mounting Style	Thermal Performance at Typical Load		Weight lbs. (grams)
				Natural Convection	Forced Convection	
291-C236AB	0.860 (21.9)	1.100 (27.0) x 0.360 (9.1)	TO-220 (Clip)	80°C @ 2W	24°C/W @ 600 LFM	0.0026 (1.18)
291-H36AB	0.860 (21.9)	1.100 (27.0) x 0.360 (9.1)	TO-220 (Mtg. Hole)	68°C @ 2W	16°C/W @ 600 LFM	0.0026 (1.18)

**Material:** Aluminum, Black Anodized

#### MECHANICAL DIMENSIONS

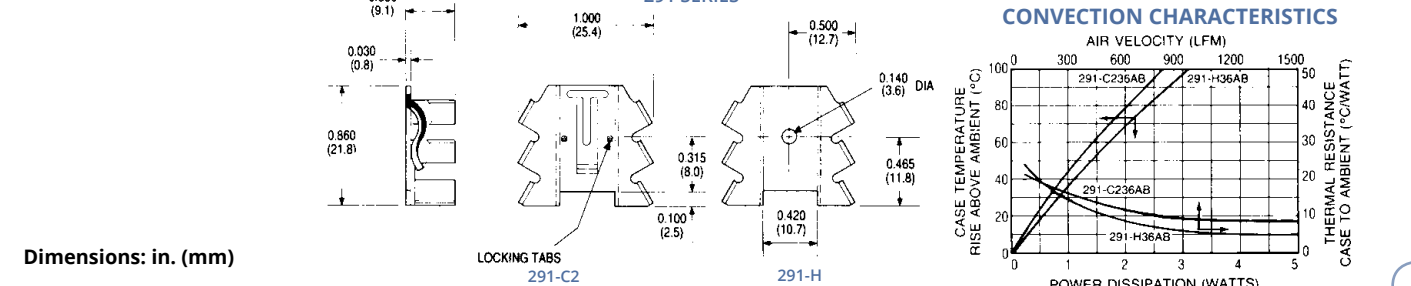

**Dimensions: in. (mm)**



## BOARD LEVEL POWER SEMICONDUCTOR HEAT SINKS



### 286 SERIES

#### ALUMINUM AND COPPER LOW-COST WAVE-SOLDERABLE HEAT SINKS

TO-220

Efficient heat removal at low cost can be achieved by inserting the **286 Series** directly into pre-drilled circuit boards; scored mounting tabs may be bent after insertion to provide added stability. The **286 Series** can be wave-soldered directly to the board. See also 286DB Series on page 55.

Standard P/N	Height Above PC Board in. (mm)	Maximum Footprint in. (mm)	Material	Thermal Performance at Typical Load		Weight lbs. (grams)
				Natural Convection	Forced Convection	
286-AB	1.190 (30.2)	1.000 (25.4) x 0.500 (12.7)	Aluminum, Anodized	58°C @ 4W	7.4°C/W @ 200 LFM	0.0085 (3.86)
286-CBTE	1.190 (30.2)	1.000 (25.4) x 0.500 (12.7)	Copper, Black	58°C @ 4W	7.4°C/W @ 200 LFM	0.0250 (11.34)
286-CTE	1.190 (30.2)	1.000 (25.4) x 0.500 (12.7)	Copper, Tinned	58°C @ 4W	7.4°C/W @ 200 LFM	0.0250 (11.34)

**Material:** 286-AB style (aluminum, black anodized), 286-CBT style (copper, black paint tin tabs), and 286-CT style (copper, tinned).

#### MECHANICAL DIMENSIONS

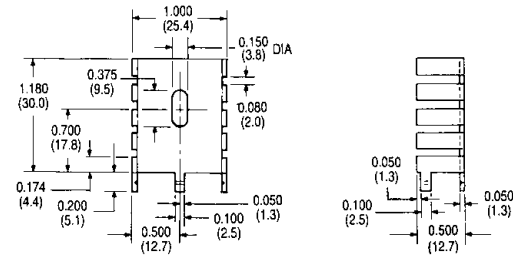

Dimensions: in. (mm)

#### NATURAL AND FORCED CONVECTION CHARACTERISTICS

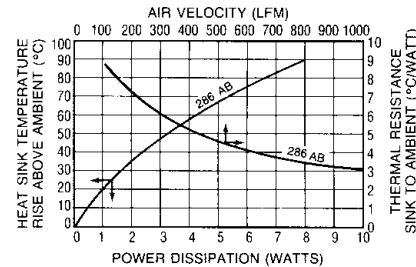

#### WAVE-SOLDERABLE LOW-COST HEAT SINKS

### 287 SERIES

TO-220

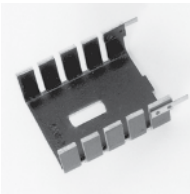

Mount these cost-effective TO-220 heat sinks vertically into pre-drilled printed circuit boards. Soldered, pre-tinned tabs can be wavesoldered directly to the board. A 0.375 in. (9.5 mm) mounting slot allows for correct positioning of TO-220 and similar semiconductor packages.

Standard P/N		Height Above PC Board in. (mm)	Maximum Footprint "A" in. (mm)	Thermal Performance at Typical Load		Weight lbs. (grams)
Mounting Slot	Mounting Hole			Natural Convection	Forced Convection	
287-1ABE	287-1ABH	1.180 (30.0)	1.000 (25.4) x 0.500 (12.7)	65°C @ 4W	7.8°C/W @ 200 LFM	0.0090 (4.08)
287-2ABE	287-2ABH	1.180 (30.0)	1.000 (25.4) x 1.000 (25.4)	55°C @ 4W	6.4°C/W @ 200 LFM	0.0140 (6.35)

**Material:** Aluminum, Black Anodized

#### MECHANICAL DIMENSIONS

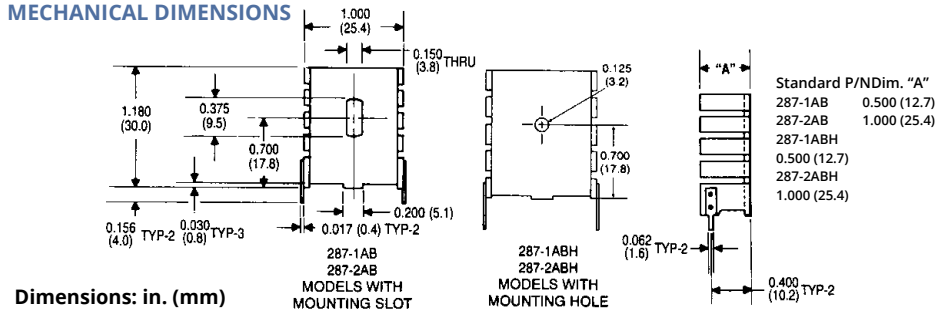

Dimensions: in. (mm)

#### NATURAL AND FORCED CONVECTION CHARACTERISTICS

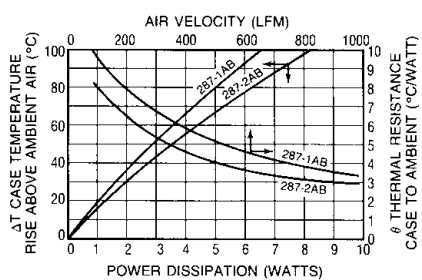

#### 285 SC AND 330 SC SPEEDCLIPS™

### 285 & 330 SERIES



SpeedClips™ employ a locking safety tab for mounting. Must be ordered separately for these heat sink series. Use these SpeedClips™ with our 237, 240, and 252 Series heat sinks for the lowest production assembly time and cost. Order one SpeedClip™ for each heat sink purchased. Must be purchased with heat sinks.

Standard P/N	Nominal Installed Loading Force	For Use With Series	Material	Weight lbs. (grams)
285 SC	10 lbs	232, 237, 240, 252, 667	Carbon Steel	0.00053 (0.24)
330 SC	4 lbs	232, 237, 240, 252, 667	Stainless Steel	0.00074 (0.34)

#### MECHANICAL DIMENSIONS

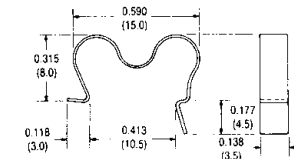

Speed Clip  
330 SC  
4 lb (17.8N)  
Nominal Force Installed

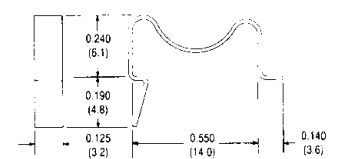

Speed Clip  
285 SC  
10 lb (44.5N)  
Nominal Force Installed

Dimensions: in. (mm)

### 695 SERIES

#### SPACE-SAVING HEAT SINKS FOR SMALL STUD-MOUNTED DIODES

Stud-Mount

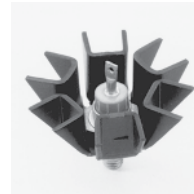

Mount and effectively heat sink small stud-mounted diodes with the **695 Series** space-saving heat sink type. Each unit is black anodized aluminum with an 0.200 in. (5.1) dia. mounting hole centered in the base. The folded fin design provides good heat dissipation for use where height is limited above the printed circuit board or base plate.

Standard P/N	Maximum Width in. (mm)	Height in. (mm)	Thermal Performance at Typical Load		Weight lbs. (grams)
			Natural Convection	Forced Convection	
695-1B	1.330 (33.8)	0.530 (13.7)	72°C @ 4.0W	5.2°C/W @ 400 LFM	0.008 (4.0)

#### MECHANICAL DIMENSIONS

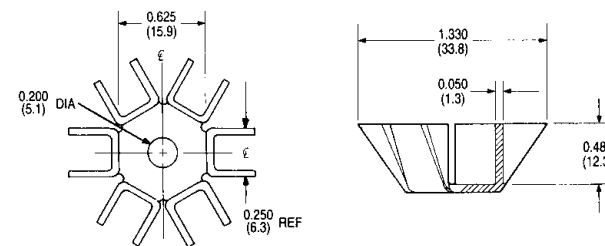

Dimensions: in. (mm)

#### NATURAL AND FORCED CONVECTION CHARACTERISTICS

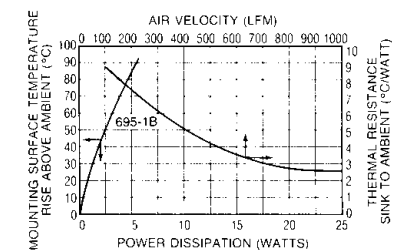

# BOARD LEVEL POWER SEMICONDUCTOR HEAT SINKS

## 260 SERIES

CUP CLIPS FOR TO-5 CASE STYLE SEMICONDUCTORS

TO-5

Characteristics	TO-5
Thermal Resistance – Epoxy Insulated	14° C/W
Breakdown Voltage – Epoxy Type (VAC), 60 Hz	500
Recommended Operating Voltage, AC or DC	
Clean Conditions: % Hipot Rating	50
Dusty Conditions: % Hipot Rating	30
Dirty Conditions: % Hipot Rating	10 to 20
Temperature Range — Continuous (C°)	-73/+149

Model	Depth of Tapped Base
260-4T5E	0.093 (2.36)
260-4TH5E	0.125 (3.18)

<b>Thread Size:</b>	4 = #4-40 UNC 6 = #6-32 UNC	<b>Base Style:</b> H = hex <b>Semiconductor Case Style:</b> 5 = TO-5
<b>Mounting Style:</b>	T = tapped S = stud P = plain	<b>Insulation:</b> E = epoxy

Standard P/N	Outline Dimension Insulation Type	L x W x I.D. in. (mm)	Weight lbs. (grams)	Case Style
260-4T5E	Epoxy Insulated	0.370 (9.4) x 0.380 (9.7) dia. x 0.290 (7.4)	0.0024 (1.09)	TO-5
260-4TH5E	Epoxy Insulated	0.400 (10.2) x 0.370 (9.4) hex. x 0.290 (7.4)	0.0031 (1.41)	TO-5
260-6SH5E	Epoxy Insulated	0.557 (14.1) x 0.370 (9.4) hex. x 0.290 (7.4)	0.0037 (1.68)	TO-5

**Materials and Finish:** Cups – beryllium copper, black ebonol "C"; Bases – brass, black ebonol "C"

### Base Mounting Configurations — TO-5

**Plain Type** — Epoxy bonded, or used with #4 pan head screws.

**Tapped Base** — #4-40 UNC screw (not supplied) fits tapped hole. Care should be taken not to use too long a screw, which could short against the semiconductor case. For correct screw lengths:

$$\text{Correct Screw Length (L)} = \text{Depth of Base} + \text{Panel Thickness} + \text{Washer Thickness}$$

**Stud Mounting Base.** #6-32 UNC. Nuts and washers not supplied. Stud hole must be slightly countersunk to ensure flat mounting.

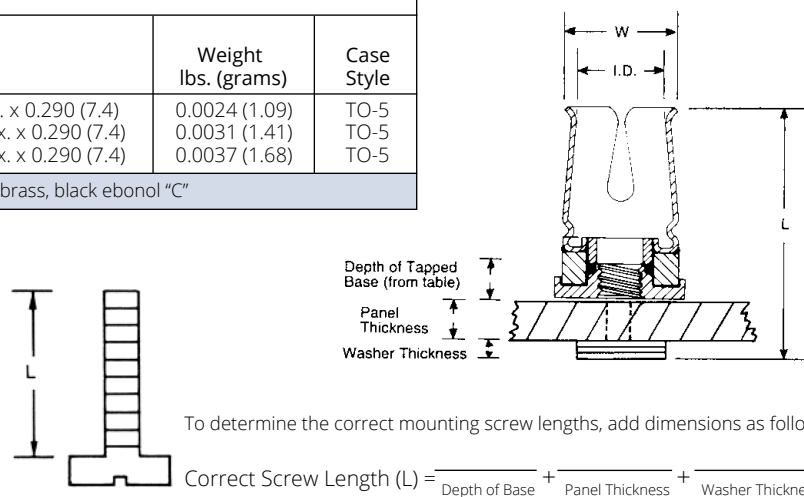

EPOXY INSULATED FOR TO-5

## 260 SERIES

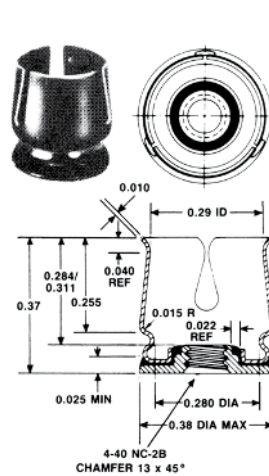

260-4T5E

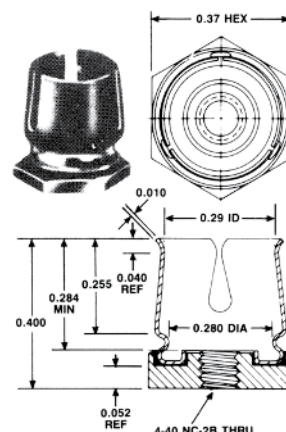

260-4TH5E

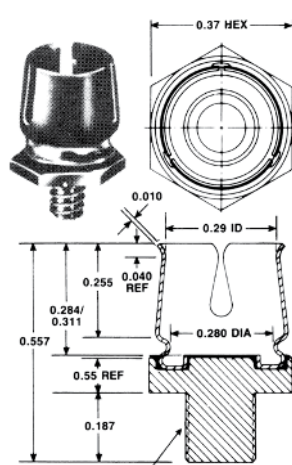

260-6SH5E

Diodes

THERMAL LINKS FOR FUSED GLASS DIODES

## 258 SERIES

The thermal resistance from diode leads to chassis or heat sink is 12°C/watt, when unit is mounted with TYPE 120 joint Compound. If a 10°C/watt chassis or sink to ambient impedance is available, the thermal resistance from the diode leads to ambient is reduced from about 150°C/watt to 22°C/watt.

Standard P/N	Dimensions in. (mm)	Material	Finish	Weight lbs. (grams)
258	0.500 (12.7) x 0.250 (6.4) x 0.340 (8.6)	Aluminum	DeltaCoate™ 151 on all surfaces except solder pads and base	0.0018 (0.82)

### MECHANICAL DIMENSIONS

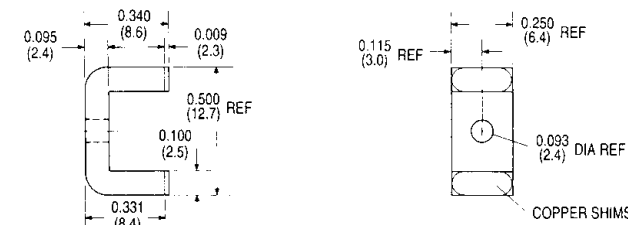

Dimensions: in. (mm)

## 634 SERIES

SLIM PROFILE UNIDIRECTIONAL FIN VERTICAL MOUNT HEAT SINK

TO-220 and TO-218

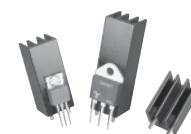

These slim profile unidirectional fin heat sinks offer users two assembly alternatives for vertically mounting TO-220 and TO-218 components. Models are available with or without wave-solderable pins on 0.40 in. (10.2) centers, making them ideal for a variety of applications where quick assembly is needed and space is at a premium.

Standard P/N		Height Above PC Board in. (mm)	Footprint Dimensions in. (mm)	Weight lbs. (grams)
Plain Pin	Without Pin			
634-10ABEP	634-10AB	1.000 (25.4)	0.640 (16.26) x 0.640 (16.26)	0.016 (7.48)
634-15ABEP	634-15AB	1.500 (38.1)	0.640 (16.26) x 0.640 (16.26)	0.025 (11.21)
634-20ABEP	634-20AB	2.000 (50.8)	0.640 (16.26) x 0.640 (16.26)	0.033 (14.95)

**Material:** Aluminum, Black Anodized.

### MECHANICAL DIMENSIONS

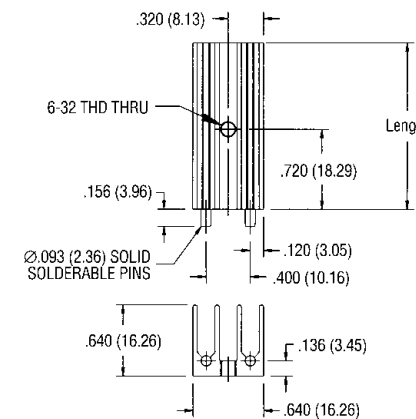

### TYPICAL THERMAL PERFORMANCE FOR 634-15ABP

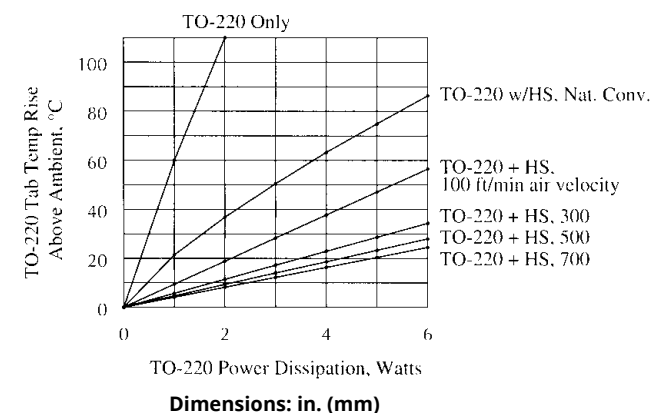

### NOTES:

1. Thermal compound is assumed between device and heat sink.
2. Tab temp with longer heat sink (634-20ABP) will typically be about 15% cooler. Tab temp with shorter heat sink (634-10ABP) will typically be about 25% higher.

## BOARD LEVEL POWER SEMICONDUCTOR HEAT SINKS



### 292 SERIES HEAT SINK FOR SINGLE TO-92

TO-92

Power semiconductors packaged in a TO-92 style plastic case can be cooled effectively at little additional cost with the addition of the 292-AB heat sink. The 292-AB is effective over the typical power range of such devices.

Standard P/N	Height Above PC Board in. (mm)	Overall Fin Width in. (mm)	Thermal Performance		Finish	Weight lbs. (grams)
			Natural Convection	Forced Convection		
292-AB	0.750 (19.1)	0.600 (15.3)	0.225°C/W @ 0.250 W		Black Anodized	0.00049 (0.22)

**Material:** Aluminum, Black Anodized

#### MECHANICAL DIMENSIONS

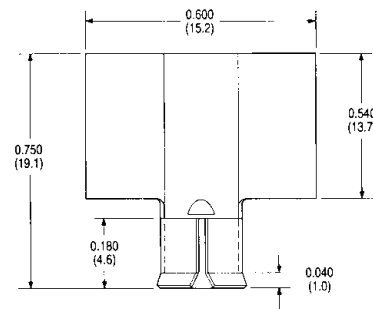

Dimensions: in. (mm)

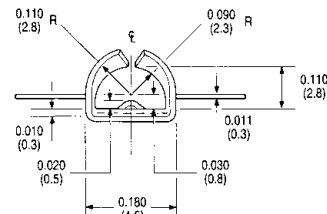

#### NATURAL AND FORCED CONVECTION CHARACTERISTICS

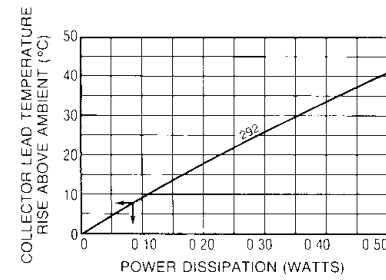

### HIGH-EFFICIENCY HEAT SINKS FOR VERTICAL BOARD MOUNTING

TO-220

### 637 SERIES

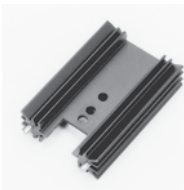

Wave-solderable pins on 1 in. centers for vertical mounting on printed circuit boards. Maximum semiconductor package width 0.625 in. (15.9). Use this heat sink where weight and board space occupied must be minimized. Refer to the Accessory products section for thermal interface materials, thermal compounds, and other accessories products.

Standard P/N	Height Above PC Board "A" in. (mm)	Maximum Footprint in. (mm)	Thermal Performance at Typical Load		Weight lbs. (grams)
			Natural Convection	Forced Convection	
637-10ABEP	1.000 (25.4)	1.375 (34.9) x 0.500 (12.7)	76°C @ 6W	5.8°C/W @ 200 LFM	0.023 (10.43)
637-15ABEP	1.500 (38.1)	1.375 (34.9) x 0.500 (12.7)	65°C @ 6W	5.5°C/W @ 200 LFM	0.035 (15.88)
637-20ABEP	2.000 (50.8)	1.375 (34.9) x 0.500 (12.7)	55°C @ 6W	4.7°C/W @ 200 LFM	0.050 (22.68)
637-25ABEP	2.500 (63.5)	1.375 (34.9) x 0.500 (12.7)	48°C @ 6W	4.2°C/W @ 200 LFM	0.062 (28.12)

**Material:** Aluminum, Black Anodized

#### MECHANICAL DIMENSIONS

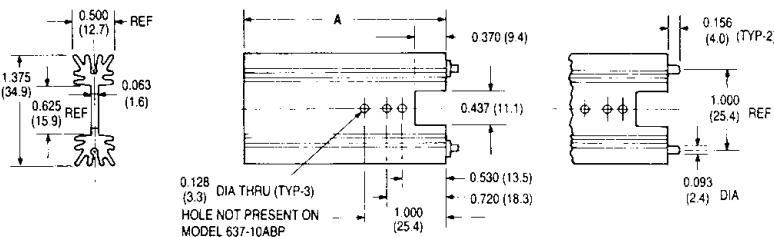

Dimensions: in. (mm)

#### 637 SERIES (EXTRUSION PROFILE 5183)

#### NATURAL AND FORCED CONVECTION CHARACTERISTICS

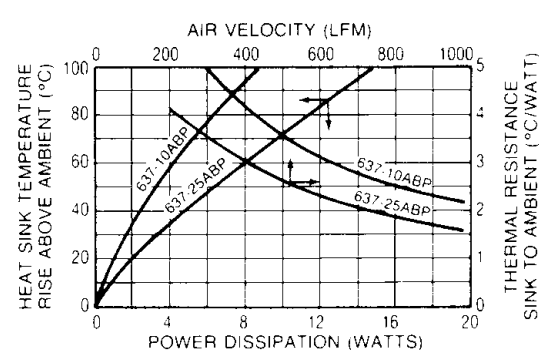

### LABOR-SAVING SPEEDCLIP™ HEAT SINKS FOR VERTICAL BOARD MOUNTING

TO-220

### 667 SERIES

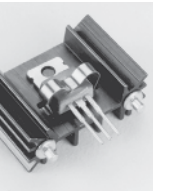

Excellent performance, choice of wave-solderable plain pins (PP-Type) or wave-solderable hex-shaped standoff pins (SP-Type), and reduced assembly cost.

Standard P/N Standoff Pin	Standard P/N Plain Pin	Height Above PC Board "A" in. (mm)	Maximum Footprint in. (mm)	Thermal Performance at Typical Load		Weight lbs. (grams)
				Natural Convection	Forced Convection	
667-10ABESP	667-10ABPP	1.000 (25.4)	1.375 (34.9) x 0.500 (12.7)	76°C @ 6W	5.8°C/W @ 200 LFM	0.0240 (11.0)
667-15ABESP	667-15ABPP	1.500 (38.1)	1.375 (34.9) x 0.500 (12.7)	66°C @ 6W	5.5°C/W @ 200 LFM	0.0340 (15.6)
667-20ABESP	667-20ABPP	2.000 (50.8)	1.375 (34.9) x 0.500 (12.7)	58°C @ 6W	4.7°C/W @ 200 LFM	0.0460 (21.0)
667-25ABESP	667-25ABPP	2.500 (63.5)	1.375 (34.9) x 0.500 (12.7)	48°C @ 6W	4.2°C/W @ 200 LFM	0.0580 (26.2)

Order 330 SC or 285 SC SpeedClip™ separately.

Wave-solderable pins. Material: Aluminum, Black Anodized

#### MECHANICAL DIMENSIONS

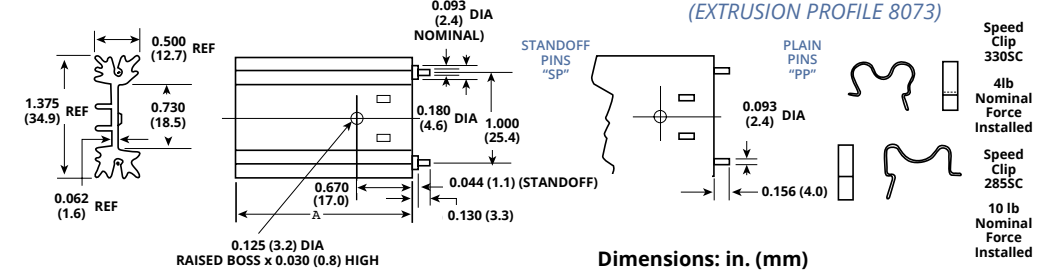

Dimensions: in. (mm)

#### 667 SERIES (EXTRUSION PROFILE 8073)

#### NATURAL AND FORCED CONVECTION CHARACTERISTICS

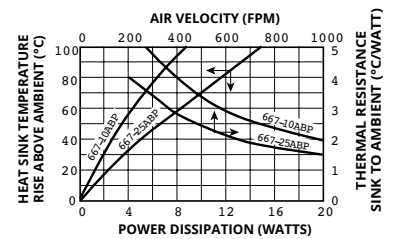

### 626 & 627 SERIES

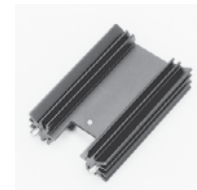

### HIGH-EFFICIENCY HEAT SINKS FOR VERTICAL BOARD MOUNTING

TO-220 and TO-18

Standard P/N	Standard P/N	Height Above PC Board "A" in. (mm)	Maximum Footprint in. (mm)	Thermal Performance at Typical Load	
				Natural Convection	Forced Convection
626-10ABEP	627-10ABP	1.000 (25.4)	1.375 (34.9) x .500 (12.7)	76°C @ 6W	5.8°C/W @ 200 LFM
626-15ABEP	627-15ABP	1.500 (38.1)	1.375 (34.9) x .500 (12.7)	65°C @ 6W	5.5°C/W @ 200 LFM
626-20ABEP	627-20ABP	2.000 (50.8)	1.375 (34.9) x .500 (12.7)	55°C @ 6W	4.7°C/W @ 200 LFM
626-25ABEP	627-25ABP	2.500 (63.5)	1.375 (34.9) x .500 (12.7)	48°C @ 6W	4.2°C/W @ 200 LFM

**Wave-solderable pins. Material:** Aluminum, Black Anodized

#### MECHANICAL DIMENSIONS

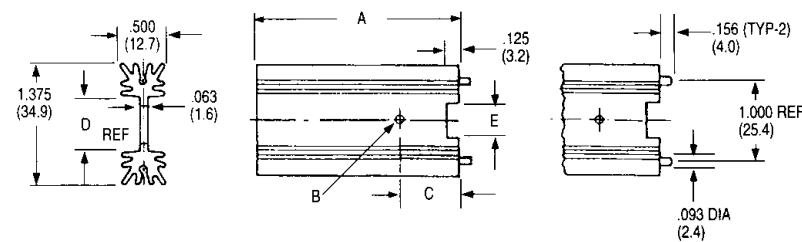

Dimensions: in. (mm)

#### 626 AND 627 SERIES

#### NATURAL AND FORCED CONVECTION CHARACTERISTICS

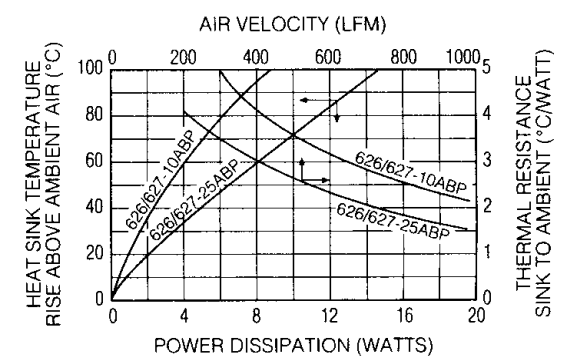

Series	Type Device	Hole Diameter "B"	Hole Height "C"	Webb Width "D"	Notch Width "E"	Extrusion Profile
626	TO-218	.144 (3.7)	.850 (21.6)	.660 (16.8)	.540 (13.7)	8420
627	TO-220	.128 (3.3)	.720 (18.3)	.625 (15.9)	.437 (11.1)	5183



## BOARD LEVEL POWER SEMICONDUCTOR HEAT SINKS

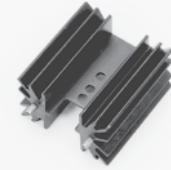

### 647 SERIES

HIGH-PERFORMANCE HEAT SINKS FOR VERTICAL BOARD MOUNTING

TO-220

Wave-solderable pins on 1 in. centers for vertical mounting of larger devices on printed circuit boards. Maximum semiconductor package width: 0.625 (15.9). Refer to the Accessory Products section for thermal interface materials, 126 Series silicone-free thermal compounds, and other accessories products.

Standard P/N	Height Above PC Board "A" in. (mm)	Maximum Footprint in. (mm)	Thermal Performance at Typical Load		Weight lbs. (grams)
			Natural Convection	Forced Convection	
647-10ABEP	1.000 (25.4)	1.650 (41.9) x 1.000 (25.4)	42°C @ 6W	3.8°C/W @ 200 LFM	0.055 (24.95)
647-15ABEP	1.500 (38.1)	1.650 (41.9) x 1.000 (25.4)	37°C @ 6W	3.5°C/W @ 200 LFM	0.075 (34.02)
647-175ABEP	1.750 (44.5)	1.650 (41.9) x 1.000 (25.4)	34°C @ 6W	3.3°C/W @ 200 LFM	0.090 (40.82)
647-20ABEP	2.000 (50.8)	1.650 (41.9) x 1.000 (25.4)	31°C @ 6W	3.1°C/W @ 200 LFM	0.104 (47.17)
647-25ABEP	2.500 (63.5)	1.650 (41.9) x 1.000 (25.4)	25°C @ 6W	2.8°C/W @ 200 LFM	0.125 (56.70)

Material: Aluminum, Black Anodized

#### MECHANICAL DIMENSIONS

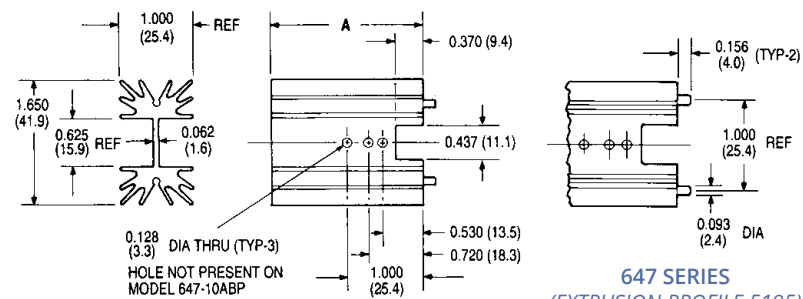

Dimensions: in. (mm)

647 SERIES  
(EXTRUSION PROFILE 5195)

#### NATURAL AND FORCED CONVECTION CHARACTERISTICS

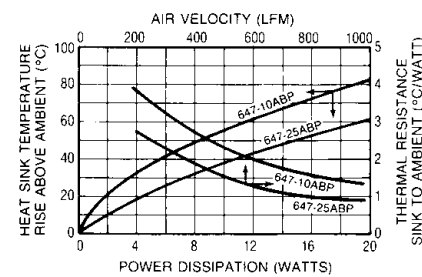

## HIGH-PERFORMANCE NOTCHED HEAT SINKS FOR VERTICAL BOARD MOUNTING

TO-218; TO-247; TO-220

### 657 SERIES

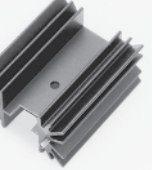

Standard P/N	Height Above PC Board "A" in. (mm)	Maximum Footprint in. (mm)	Thermal Performance at Typical Load	
			Natural Convection	Forced Convection
657-10ABEPN	1.000 (25.4)	1.650 (41.9) x 1.000 (25.4)	41°C @ 6W	3.7°C/W @ 200 LFM
657-15ABEPN	1.500 (38.1)	1.650 (41.9) x 1.000 (25.4)	38°C @ 6W	3.3°C/W @ 200 LFM
657-20ABEPN	2.000 (50.8)	1.650 (41.9) x 1.000 (25.4)	32°C @ 6W	2.9°C/W @ 200 LFM
657-25ABEPN	2.500 (63.5)	1.650 (41.9) x 1.000 (25.4)	25°C @ 6W	2.7°C/W @ 200 LFM

Wave-solderable pins. Material: Aluminum, Black Anodized

#### MECHANICAL DIMENSIONS

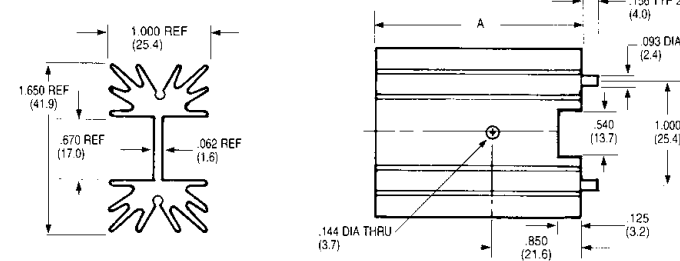

Dimensions: in. (mm)

657 SERIES  
(EXTRUSION PROFILE 6533)

#### NATURAL AND FORCED CONVECTION CHARACTERISTICS

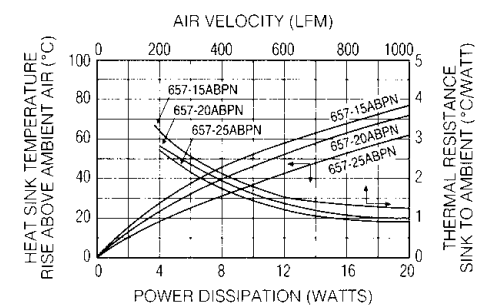

## HIGH-PERFORMANCE HEAT SINKS FOR VERTICAL BOARD MOUNTING

TO-218; TO-247; TO-220

### 657 SERIES

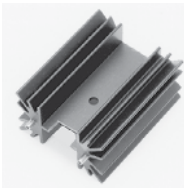

Standard P/N	Height Above PC Board "A" in. (mm)	Maximum Footprint in. (mm)	Thermal Performance at Typical Load		Weight lbs (grams)
			Natural Convection	Forced Convection	
657-10ABEP	1.000 (25.4)	1.650 (41.9) x 1.000 (25.4)	41°C @ 6W	3.7°C/W @ 200 LFM	0.0515 (23.36)
657-15ABEP	1.500 (38.1)	1.650 (41.9) x 1.000 (25.4)	38°C @ 6W	3.3°C/W @ 200 LFM	0.0760 (34.60)
657-20ABEP	2.000 (50.8)	1.650 (41.9) x 1.000 (25.4)	32°C @ 6W	2.9°C/W @ 200 LFM	0.1030 (47.00)
657-25ABEP	2.500 (63.5)	1.650 (41.9) x 1.000 (25.4)	25°C @ 6W	2.7°C/W @ 200 LFM	0.1250 (57.00)

Wave-solderable pins. Material: Aluminum, Black Anodized

#### MECHANICAL DIMENSIONS

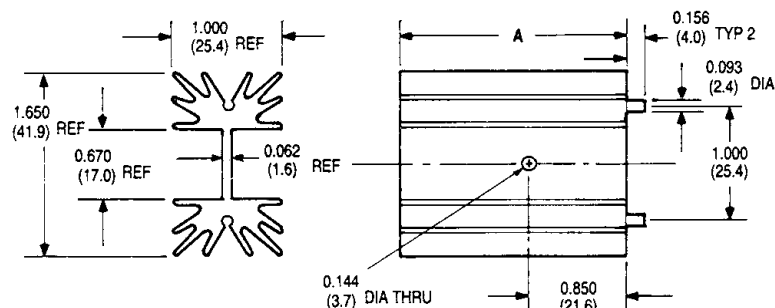

Dimensions: in. (mm)

657 SERIES  
(EXTRUSION PROFILE 6533)

#### NATURAL AND FORCED CONVECTION CHARACTERISTICS

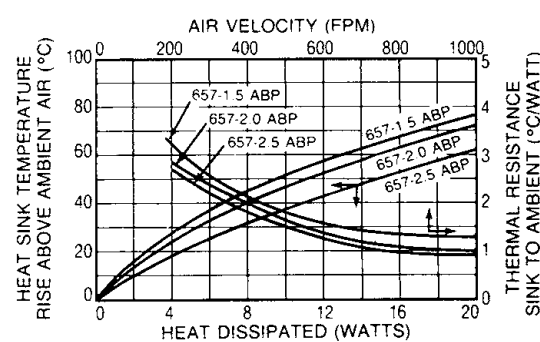

## HIGH-PERFORMANCE HEAT SINKS WITH SPEEDCLIPS™ FOR VERTICAL BOARD MOUNTING

TO-218; TO-247; TO-220

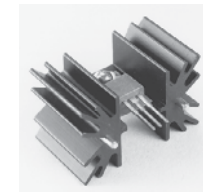

### 657 SERIES

Standard P/N	Height Above PC Board "A" in. (mm)	Maximum Footprint in. (mm)	Thermal Performance at Typical Load	
			Natural Convection	Forced Convection
657-10ABEPSC	1.000 (25.4)	1.650 (41.9) x 1.000 (25.4)	41°C @ 6W	3.7°C/W @ 200 LFM
657-15ABEPSC	1.500 (38.1)	1.650 (41.9) x 1.000 (25.4)	38°C @ 6W	3.3°C/W @ 200 LFM
657-20ABEPSC	2.000 (50.8)	1.650 (41.9) x 1.000 (25.4)	32°C @ 6W	2.9°C/W @ 200 LFM
657-25ABEPSC	2.500 (63.5)	1.650 (41.9) x 1.000 (25.4)	25°C @ 6W	2.7°C/W @ 200 LFM

Wave-solderable pins. Material: Aluminum, Black Anodized

#### MECHANICAL DIMENSIONS

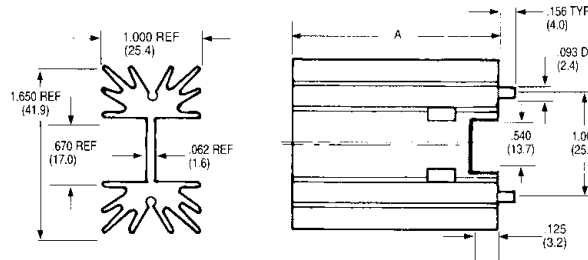

Dimensions: in. (mm)

SPEEDCLIP™ INCLUDED IN ORDER

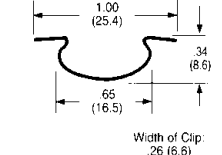

657 SERIES  
(EXTRUSION PROFILE 6533)

#### NATURAL AND FORCED CONVECTION CHARACTERISTICS

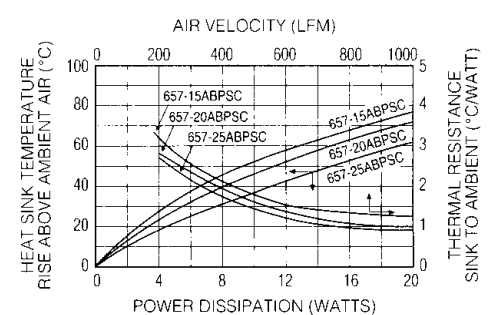

# BOARD LEVEL POWER SEMICONDUCTOR HEAT SINKS

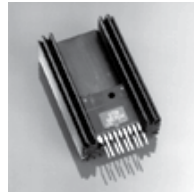

## 677 SERIES

HIGH-PERFORMANCE, HIGH-POWER HEAT SINKS FOR VERTICAL BOARD MOUNTING

TO-218; TO-220; TO-247;  
15-Lead Multiwatt

Standard P/N	Height Above PC Board "A" in. (mm)	Maximum Footprint in. (mm)	Thermal Performance at Typical Load	
			Natural Convection	Forced Convection
677-10ABEP	1.000 (25.4)	1.650 (41.9) x 1.000 (25.4)	52°C @ 6W	3.1°C/W @ 200 LFM
677-15ABEP	1.500 (38.1)	1.650 (41.9) x 1.000 (25.4)	46°C @ 6W	2.8°C/W @ 200 LFM
677-20ABEP	2.000 (50.8)	1.650 (41.9) x 1.000 (25.4)	40°C @ 6W	2.5°C/W @ 200 LFM
677-25ABEP	2.500 (63.5)	1.650 (41.9) x 1.000 (25.4)	35°C @ 6W	2.2°C/W @ 200 LFM

Wave-solderable pins. Material: Aluminum, Black Anodized

### MECHANICAL DIMENSIONS

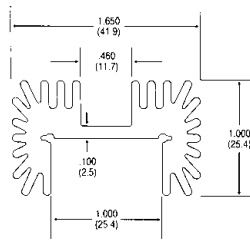

Dimensions: in. (mm)

677 SERIES  
(EXTRUSION  
PROFILE 8719)

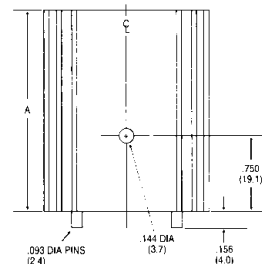

### NATURAL AND FORCED CONVECTION CHARACTERISTICS

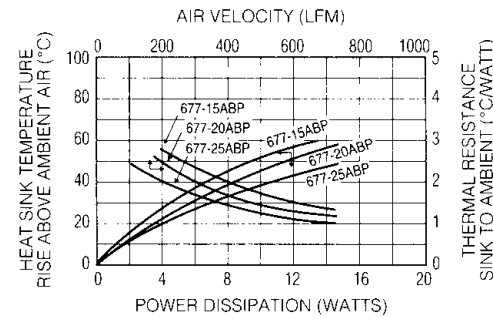

## HIGHEST EFFICIENCY/LOWEST UNIT COST HEAT SINKS

TO-3; TO-66; TO-220

## 690 SERIES

These low-cost heat sinks provide the most power dissipation at the lowest unit cost and are available in three standard types to mount and cool one TO-3 or TO-66 metal power semiconductor type or two plastic package TO-220 power semiconductor types. For higher power semiconductors, the 690 Series can dissipate up to 20 watts while maintaining a mounting surface temperature rise above ambient air temperature of no more than 91°C.



Standard P/N	Height Above PC Board in. (mm)	Outline Dimensions in. (mm)	Thermal Performance at Typical Load		Semiconductor Mounting Hole Pattern	Weight lbs. (grams)
			Natural Convection	Forced Convection		
690-3B	1.310 (33.3)	1.860 (47.2)-sq	44°C @ 7.5W	2.0°C/W @ 400 LFM	(1) TO-3	0.0700 (31.75)
690-66B	1.310 (33.3)	1.860 (47.2)-sq	44°C @ 7.5W	2.0°C/W @ 400 LFM	(1) TO-66	0.0700 (31.75)
690-220B	1.310 (33.3)	1.860 (47.2)-sq	44°C @ 7.5W	2.0°C/W @ 400 LFM	(2) TO-220	0.0700 (31.75)

Material: Aluminum, Black Anodized

### MECHANICAL DIMENSIONS

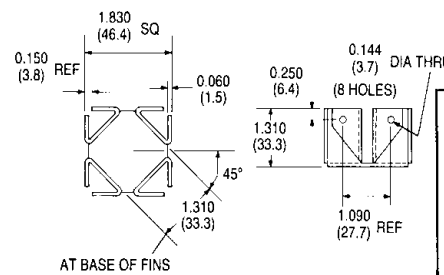

Dimensions: in. (mm)

### SEMICONDUCTOR MOUNTING HOLES

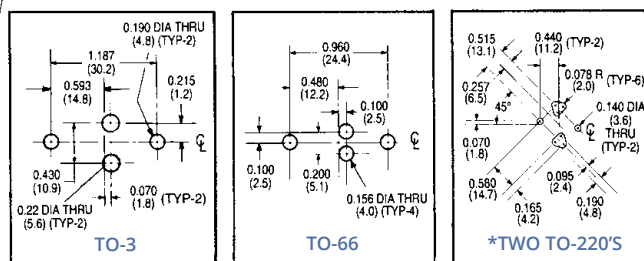

### NATURAL AND FORCED CONVECTION CHARACTERISTICS

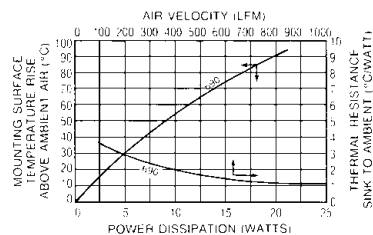

## MAXIMUM EFFICIENCY OMNIDIRECTIONAL HEAT SINKS

TO-3; TO-220

## 680 SERIES

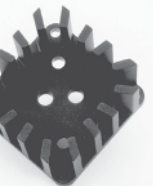

Achieve optimum natural convection cooling per unit volume occupied above the printed circuit board for TO-3 (one semiconductor package per heat sink) or for two TO-220 style cases, when this low-cost heat sink is used. Any mounting attitude will provide free circulation of air in natural convection applications. These 680 Series heat sinks can also be specified without any semiconductor mounting hole pattern by specifying suffix "K" (Example: 680-5K).

Standard P/N	Height Above PC Board "A" in. (mm)	Horizontal Mounting Footprint Dimensions in. (mm)	Thermal Performance at Typical Load		Semiconductor Mounting Hole Pattern	Weight lbs. (grams)
			Natural Convection	Forced Convection		
680-5A	0.500 (12.7)	1.810 (46.0)-sq	70°C @ 7.5W	3.0°C/W @ 400 LFM	(1) TO-3	0.0700 (31.75)
680-75A	0.750 (19.1)	1.810 (46.0)-sq	58°C @ 7.5W	2.4°C/W @ 400 LFM	(1) TO-3	0.0900 (40.82)
680-10A	1.000 (25.4)	1.810 (46.0)-sq	52°C @ 7.5W	2.0°C/W @ 400 LFM	(1) TO-3	0.0980 (44.45)
680-125A	1.250 (31.8)	1.810 (46.0)-sq	45°C @ 7.5W	1.5°C/W @ 400 LFM	(1) TO-3	0.1100 (49.90)
680-5220	0.500 (12.7)	1.810 (46.0)-sq	70°C @ 7.5W	3.0°C/W @ 400 LFM	(2) TO-220	0.0700 (31.75)
680-75220	0.750 (19.1)	1.810 (46.0)-sq	58°C @ 7.5W	2.4°C/W @ 400 LFM	(2) TO-220	0.0900 (40.82)
680-10220	1.000 (25.4)	1.810 (46.0)-sq	52°C @ 7.5W	2.0°C/W @ 400 LFM	(2) TO-220	0.0980 (44.45)
680-125220	1.250 (31.8)	1.810 (46.0)-sq	45°C @ 7.5W	1.5°C/W @ 400 LFM	(2) TO-220	0.1100 (49.90)

Material: Aluminum, Black Anodized

### MECHANICAL DIMENSIONS

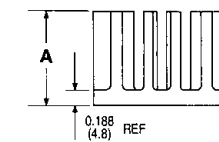
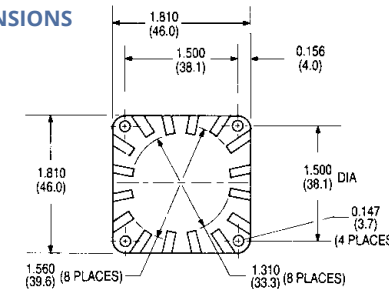

### NATURAL AND FORCED CONVECTION CHARACTERISTICS

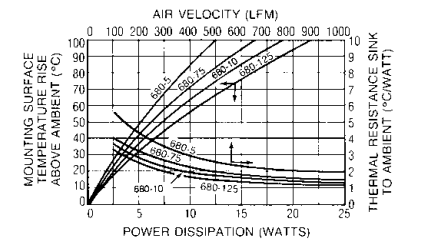

Dimensions: in. (mm)

### SEMICONDUCTOR MOUNTING HOLES

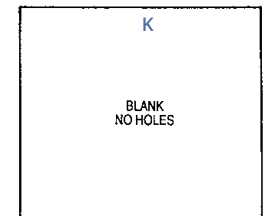
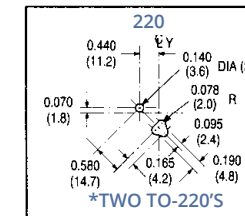
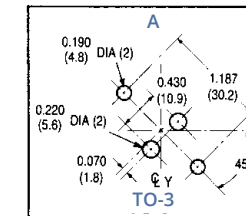

\*Only one hole pattern of two is shown. Hole patterns are symmetrical about the center lines.

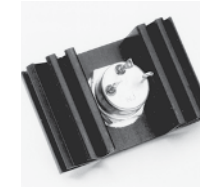

## 601 & 603 SERIES

LOW-HEIGHT HEAT SINKS

DO-4/DO-5 Diodes

Use these low-height heat sinks on printed circuit board applications for TO-66 power semiconductors and DO-4 and DO-5 diodes, where close board-to-board spacing and efficient heat dissipation are required. The 601 and 603 Series may also be attached to enclosure panels or brackets using isolation hardware where necessary.

Standard P/N	Footprint Dimensions in. (mm)	Height in. (mm)	Mounting Hole Dia. in. (mm)	Thermal Performance at Typical Load		Weight lbs. (grams)
				Natural Convection	Forced Convection	
601E	2.000 (50.8) x 1.250 (31.8)	0.562 (14.3)	0.200 (5.1)	52°C @ 5.0W	4.5°C/W @ 175 LFM	0.0500 (22.68)
601F	2.000 (50.8) x 1.250 (31.8)	0.562 (14.3)	0.270 (6.9)	52°C @ 5.0W	4.5°C/W @ 175 LFM	0.0500 (22.68)
601K	2.000 (50.8) x 1.250 (31.8)	0.562 (14.3)	None	52°C @ 5.0W	4.5°C/W @ 175 LFM	0.0500 (22.68)
603K	2.000 (50.8) x 2.000 (50.8)	0.562 (14.3)	None	41°C @ 5.0W	4.0°C/W @ 175 LFM	0.0810 (36.74)

Material: Aluminum Alloy, Black Anodized

## BOARD LEVEL POWER SEMICONDUCTOR HEAT SINKS

### 601 & 603 SERIES

LOW-HEIGHT HEAT SINKS

DO-4/DO-5 Diodes

#### MECHANICAL DIMENSIONS

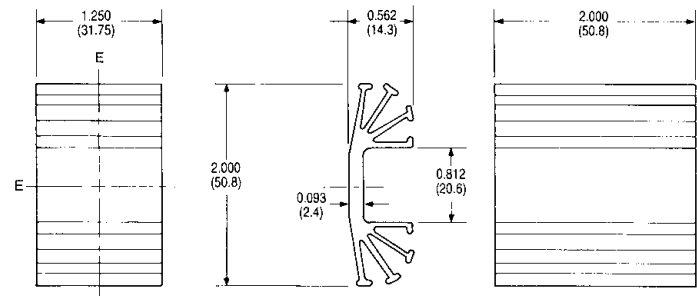

601 SERIES  
(EXTRUSION PROFILE 1284)

603 SERIES  
(EXTRUSION PROFILE 1284)

#### SEMICONDUCTOR MOUNTING HOLES

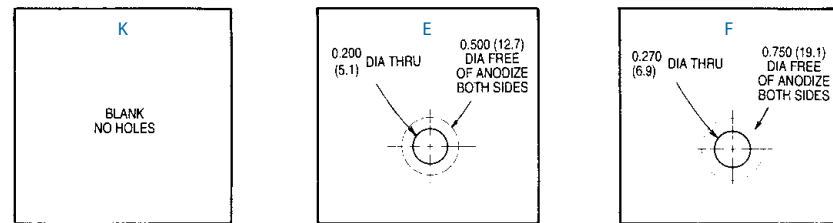

Dimensions: in. (mm)

E&F available on 601 Series only as a standard product.

#### NATURAL AND FORCED CONVECTION CHARACTERISTICS

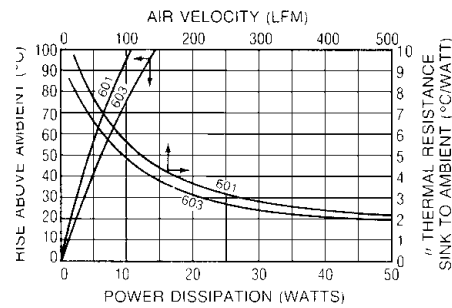

### MAXIMUM PERFORMANCE NATURAL CONVECTION HEAT SINK FOR ALL METAL-CASE SEMICONDUCTORS

TO-3

### 641 SERIES

Available with a standard TO-3 mounting hole pattern predrilled for cost-effective mounting in limited-height applications, the **641 Series** provides maximum performance in natural convection with an optimized heat sink surface area. The 641K type with an open channel area of 1.300 in. (33.0) and no predrilled mounting holes can be adapted to meet mounting requirements for most metal case power semiconductor types.

Standard P/N	Outline Dimensions in. (mm)	Height in. (mm)	Mounting Hole Pattern	Thermal Performance at Typical Load		Weight lbs. (grams)
				Natural Convection	Forced Convection	
641A	4.125 (104.8) x 3.000 (76.2)	1.000 (25.4)	(1) TO-3	36°C @ 15W	0.9°C/W @ 250 LFM	0.2900 (131.54)
641K	4.125 (104.8) x 3.000 (76.2)	1.000 (25.4)	None	36°C @ 15W	0.9°C/W @ 250 LFM	0.2900 (131.54)

Material: Aluminum Alloy, Black Anodized.

#### MECHANICAL DIMENSIONS

641 SERIES  
(EXTRUSION PROFILE 1371)

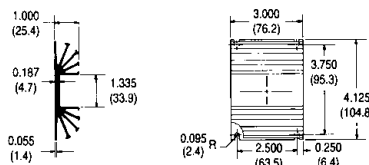

#### SEMICONDUCTOR MOUNTING HOLES

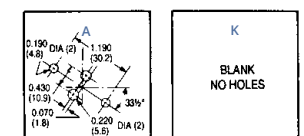

Dimensions: in. (mm)

#### NATURAL AND FORCED CONVECTION CHARACTERISTICS

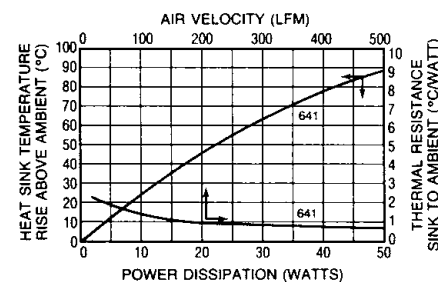

## UNIVERSAL 678 SERIES VERTICAL HEAT SINK FOR POWER DEVICES

### 678-39-S & 678-39-C



Wakefield-Vette introduces **Universal 678 series**, high performance, low cost and versatile heat sink with screw or clip for all kinds of standard packages. This type of heat sink provides both vertical and horizontal mounting options on PCB to accommodate natural and forced convection cooling method.

#### SPECIFICATIONS

- Heat Sink:** Aluminum Alloy 6063-T5 or Equivalent with either degreased or black anodized finish
- Spring Clip:** Music Wire, Per ASTM A228 with bright nickel plating
- Solder Foot:** Cold-rolled Steel, Per ASTM A-366 with pure tin over copper strike. RoHS compliant.
- Insulator (Optional):** t-Global H48-1, L37-3F and H48-6S. The thickness of the insulating material not to exceed 10 mil (0.01").

#### FEATURES AND BENEFITS

- Minimum assembly cost and labor** - Spring Clips make the mounting holes and fasteners obsolete in assembly operations & reduce costs.
- Design Flexibility** - Universal mountable and "one fits all" give designers total freedom to fit their packaging designs with ideal device pack style and to orient the heat sink to meet their power dissipations with optimized cooling method. (see page 7 of data sheet).

Part Number	Description	Length	Width	Thermal Resistance @ Forced Air Flow
678-39-S	Universal Heat Sink for TO Devices w/Screw Hole, Black Anodize	1.520" (38.61mm)	2.362" (60.00mm)	0.6°C/W @ 600 LFM
678-39-C	Universal Heat Sink for TO Devices w/ Clip, Black Anodize	1.520" (38.61mm)	2.362" (60.00mm)	0.6°C/W @ 600 LFM

#### MECHANICAL DIMENSIONS

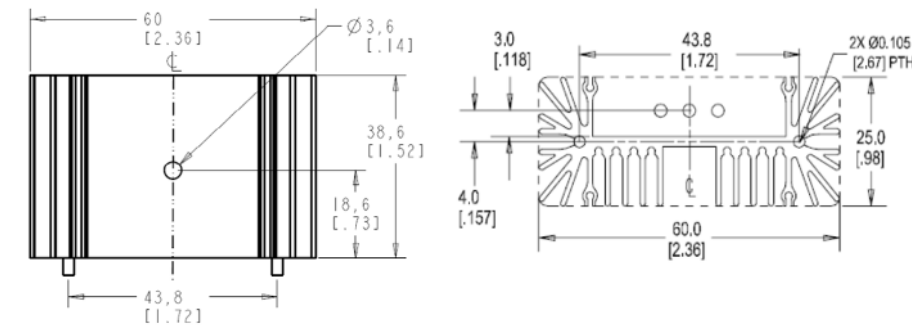

#### THERMAL PERFORMANCE

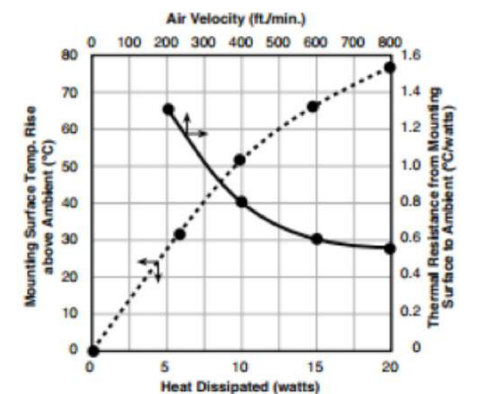



## ONE HEAT SINK FOR ALL PACKAGES

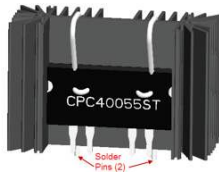

### CPC40055ST PACKAGE

Board level – 2 solder pins    Natural convection – Vertical    Spring Clip

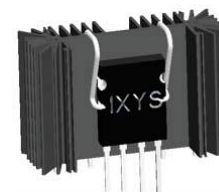

### CPC1998 PACKAGE

Board level – 2 solder pins    Natural convection – Vertical    Spring Clip

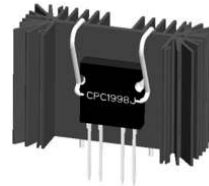

### CPC1968 AND TO-264 PACKAGE

Board level – 2 solder pins    Natural convection – Vertical    Spring Clip

### L4970A PACKAGE

Board level – 2 solder pins    Natural convection – Vertical    Screw attachment

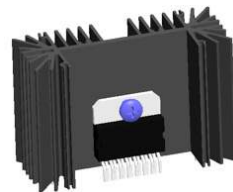

### KBU PACKAGE

Board level – 2 solder pins    Natural convection – Vertical    Spring Clip

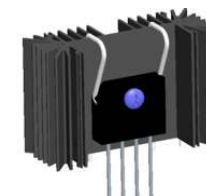

### TO-247 AND TO-220 PACKAGE

Board level – 2 solder pins    Natural convection – Vertical    Screw attachment or Spring Clip

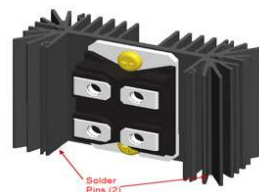
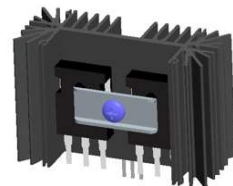

### SOT-227 PACKAGE

System level – 2 screws    Natural convection – Vertical

## MOUNTAIN SERIES HEAT SINKS FOR TO-264, TO-247 DEVICES

### MTN-264-27



Wakefield-Vette's **Mountain Series Heat Sinks** are high performance, low cost, configurable, scalable and compact with a matrix clip system for TO220, TO-247, TO-264 and other standard packages. This type powerful heat sink provides easiest assembly, largest surface areas, smallest space occupation and all-in-one solution. The power dissipations can be easily increased simply by extending the fin height on each side of the heat sink, while keeping the heat sink height and PCB layout the same. It is the ideal type of heat sink for high power density and small size (1U or 2U) electronic packaging with forced convention cooling.

#### FEATURES AND BENEFITS

- **Minimum assembly cost and labor** - Spring Clips make the mounting holes and fasteners obsolete in assembly operations and reduce costs.
- **Maximum Repeatability** - Constant spring force over repeated assembly/disassembly.
- **Maximum Reliability** - Resilient spring action locks electronic component in place. Fewer parts in assembly and no fasteners and washers required. Prevent short circuit by eliminating metal particles generated from hardware or thread tapping.
- **Maximum Thermal Transfer** - Maximum surface area per unit volume, efficient cooling fins & consistent mounting force reduces thermal resistance.

Part Number	Description	Type	Package Cooled	Attachment Method	Length	Width	Height Off Base (Height of Fin)	Thermal Resistance @ Forced Air Flow	Material	Material Finish
MTN-264-27	Heat Sink w/ Two Clips for TO-247 TO-264	Top Mount	TO-247 and TO-264	Clip and PC Pin	1.06" (27mm)	1.740" (44.3mm)	1.56" (39.5mm)	5.5°C/W @ 18 Watts	Aluminum	Black Anodized

#### MECHANICAL DIMENSIONS

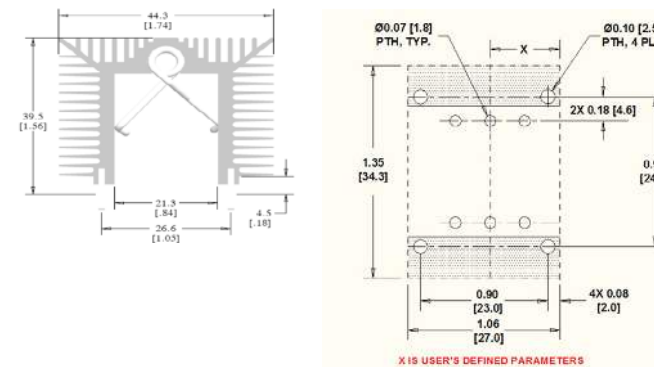

#### THERMAL RESISTANCE

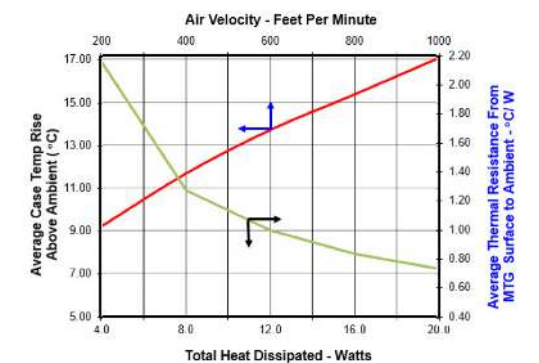

## MOUNTAIN SERIES HEAT SINKS FOR TO-264, TO-247 DEVICES



### MTN-264-55

Wakefield-Vette's **Mountain Series Heat Sinks** are high performance, low cost, configurable, scalable and compact with a matrix clip system for TO220, TO-247, TO-264 and other standard packages. This type powerful heat sink provides easiest assembly, largest surface areas, smallest space occupation and all-in-one solution. The power dissipations can be easily increased simply by extending the fin height on each side of the heat sink, while keeping the heat sink height and PCB layout the same. It is the ideal type of heat sink for high power density and small size (1U or 2U) electronic packaging with forced convection cooling.

#### FEATURES AND BENEFITS

- **Minimum assembly cost and labor** - Spring Clips make the mounting holes and fasteners obsolete in assembly operations and reduce costs.
- **Maximum Thermal Transfer** - Maximum surface area per unit volume, efficient cooling fins & consistent mounting force reduces thermal resistance.
- **Maximum Repeatability** - Constant spring force over repeated assembly/disassembly.
- **Maximum Reliability** - Resilient spring action locks electronic component in place. Fewer parts in assembly and no fasteners and washers required. Prevent short circuit by eliminating metal particles generated from hardware or thread tapping.

Part Number	Description	Type	Package Cooled	Attachment Method	Length	Width	Height Off Base (Height of Fin)	Thermal Resistance @ Forced Air Flow	Material	Material Finish
MTN-264-55	Heat Sink w/ Two Clips for TO-247 TO-264	Top Mount	TO-247 and TO-264	Clip and PC Pin	2.17" (55.11mm)	1.740" (44.3mm)	1.56" (39.5mm)	3.7°C/W @ 18 Watts	Aluminum	Black Anodized

#### MECHANICAL DIMENSIONS

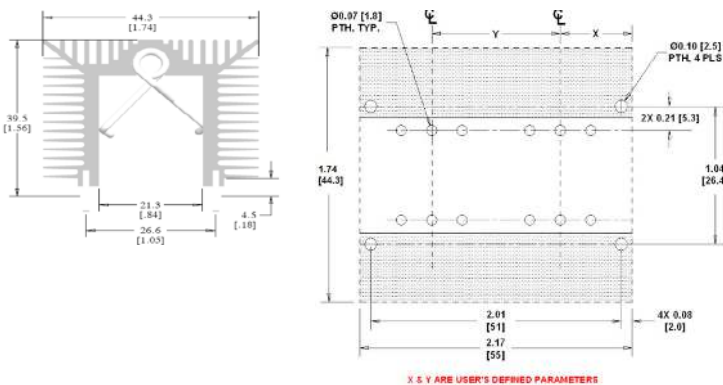

#### THERMAL RESISTANCE

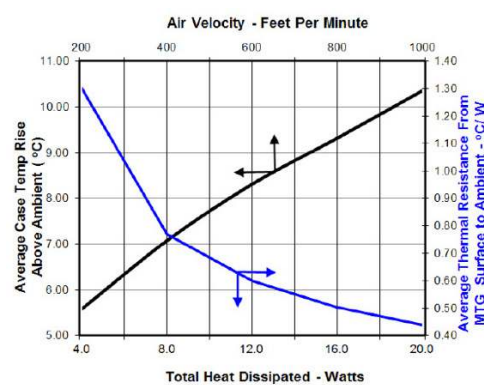

## omniKLIP™ SERIES HEAT SINK W/ CLIP(S) FOR TO-DEVICES



### HEAT SINKS OMNI-CLIP-18-L SERIES

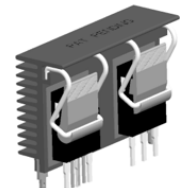

omniKlip™

The Wakefield- Vette **omniKlip Heat Sink Series** are a configurable and patented (Pat. Pending) high performance, low cost and compact solutions for TO-220, TO-247 and TO-264 , or similar packages. This powerful heat sink provides tool and fixture free assembly operation, largest surface areas and smallest space occupation. It is the ideal type of heat sink for high power density and small size (1U or 2U) electronic packaging with forced convection cooling.

#### SPECIFICATIONS

- **Heat Sink:** Aluminum Alloy 6063-T5 or Equivalent with black anodized finish.
- **Spring Clip:** Music Wire, Per ASTM A228 with bright nickel plating
- **Solder Foot:** Cold-rolled Steel, Per ASTM A-366 with pure tin over copper strike. RoHS compliant.

#### FEATURES AND BENEFITS

- **Minimum assembly cost and labor** - Spring Clips make the mounting holes, fasteners, tools and fixtures obsolete in assembly operations & reduce costs.
- **Maximum Repeatability** - Constant spring force over repeated assembly/disassembly
- **Maximum Reliability** - Resilient spring action locks electronic component in place. Fewer parts in assembly and no fasteners and washers required. Prevent short circuit by eliminating metal particles generated from hardware or thread tapping
- **Design Flexibility** - Maximum flexibility for dynamic device locations and power up grading. **"Configure-to-Fit"** gives designers total freedom to configure heat sink needed to fit their dynamic design environments.

Wkv Part Number	Description	Related Clip	Package Cooled	Length	Width	Height Off Base (Height of Fin)
OMNI-UNI-18-25	OmniKlip Heat Sink, 18mm wide, 25mm long, black anodized for TO-247 & TO-264	OMNI-UC	TO-247, TO-264	0.984" (25.00mm)	1.500" (38.10mm)	0.710" (18.03mm)
OMNI-UNI-18-50	OmniKlip Heat Sink, 18mm wide, 50mm long, black anodized for TO-247 & TO-264	OMNI-UC	TO-247, TO-264	1.969" (50.00mm)	1.500" (38.10mm)	0.710" (18.03mm)
OMNI-UNI-18-75	OmniKlip Heat Sink, 18mm wide, 75mm long, black anodized for TO-247 & TO-264	OMNI-UC	TO-247, TO-264	2.95" (75.00mm)	1.500" (38.10mm)	0.710" (18.03mm)
OMNI-220-18-25-1C	OmniKlip Heat Sink w/1 clip, 18mm wide, 25mm long, black anodized for TO-220		TO-220	0.984" (25.00mm)	1.500" (38.10mm)	0.710" (18.03mm)
OMNI-220-18-50-2C	OmniKlip Heat Sink w/2 clips, 18mm wide, 50mm long, black anodized for TO-220		TO-220	1.969" (50.00mm)	1.500" (38.10mm)	0.710" (18.03mm)
OMNI-220-18-75-3C	OmniKlip Heat Sink w/3 clips, 18mm wide, 75mm long, black anodized for TO-220		TO-220	2.95" (75.00mm)	1.500" (38.10mm)	0.710" (18.03mm)

#### MECHANICAL DIMENSIONS

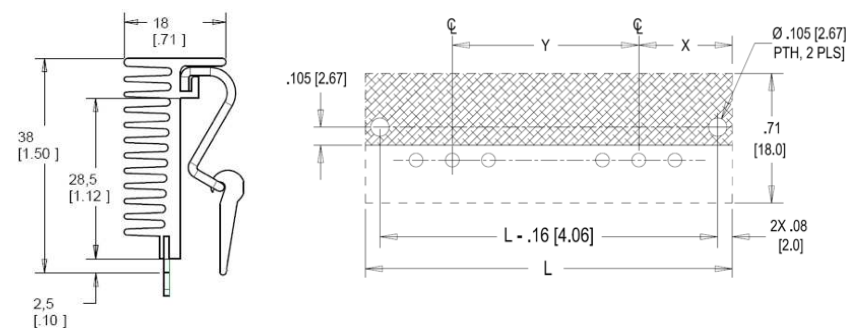

#### THERMAL PERFORMANCE (OMNI-UNI-18) TWO TO-247 DEVICES WITH SIL-PAD 900s L = 500mm[2.0"]

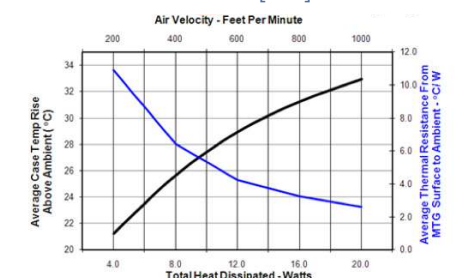

# OmniKLIP™ SERIES HEAT SINK W/ CLIP(S) FOR TO-DEVICES



## OMNI-UNI-32-L SERIES HEAT SINKS



WkV Part Number	Description	Related Cross Sell Part	Package Cooled	Shape	Length	Width	Height Off Base (Height of Fin)
OMNI-UNI-32-58	OmniKlip Heat Sink for 2 universal 2 clips, 32mm wide, 58mm long, black anodized for any TO except TO-220	OMNI-UC, OMNI-220C	TO-247, TO-264	Rectangular, Fins	2.28" (58mm)	1.25" (32mm)	1.62" (46.3mm)

### MECHANICAL DIMENSIONS

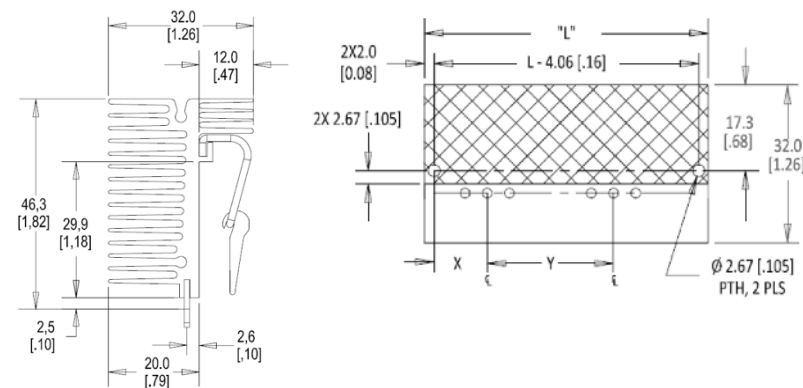

### THERMAL PERFORMANCE

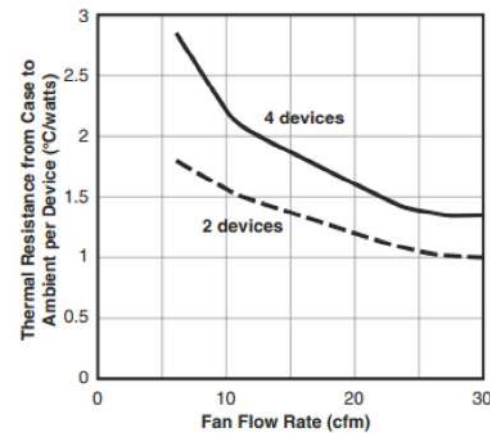

## HEAT SINKS OMNI-UNI-41-L SERIES



WkV Part Number	Description	Related Cross Sell Part	Package Cooled	Shape	Length	Width	Height Off Base (Height of Fin)
OMNI-UNI-41-75	OmniKlip Heat Sink for 2 universal 2 clips, 41mm wide, 75mm long, black anodized for any TO except TO-220	OMNI-UC, OMNI-220C	TO-247, TO-264	Rectangular, Fins	2.95" (75mm)	1.61" (41mm)	1.62" (46.3mm)

### MECHANICAL DIMENSIONS

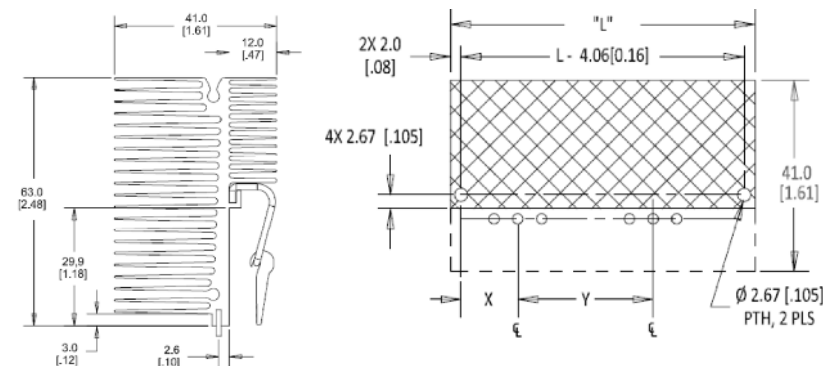

### THERMAL PERFORMANCE

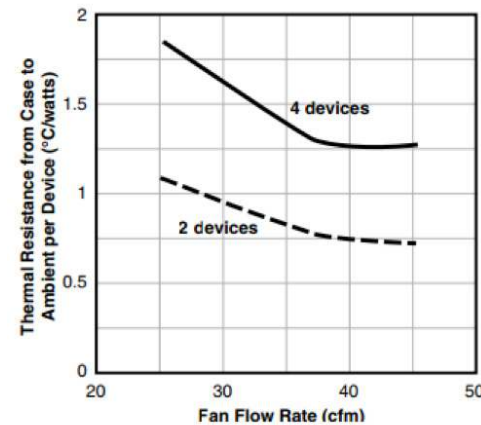

## OMNIKLIPS™



Part Number	Description
OMNI-UC	Universal Clip for omniKlip Heat Sink for any TO except TO220
OMNI-220C	Clip for omniKlip Heat Sink for TO 220

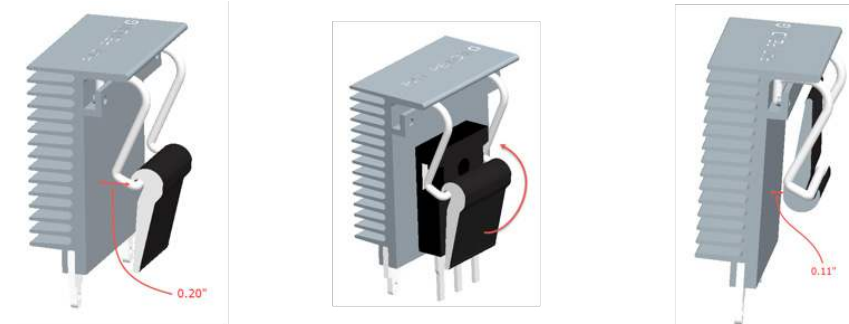

Universal Clip mechanism is rotating the bar by 180°. The eccentric circle will raise 0.09". This deformation will exert the force on the components.

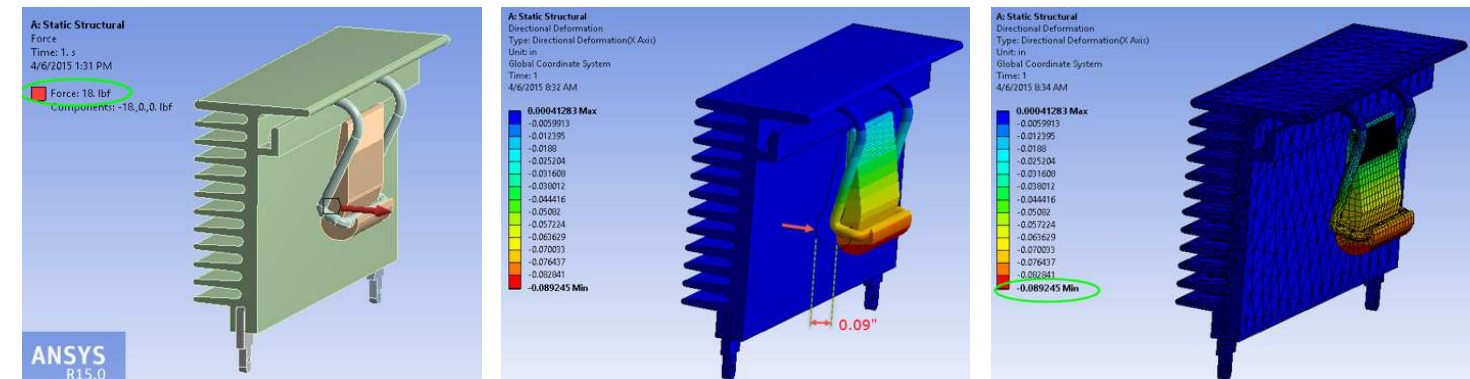

omniKlip assembly model in ANSYS, with 18 lbf load applied to the clip

Under the 18 lbf, the clip deformed 0.09" from its original position to the final

Directional deformation plot as shown.

With the FEA analysis and simulation, the force applied to the TO-series components will be at least 18 lbs.



## ADDITIONAL CONFIGURATIONS



**OMNI-UNI-32-L SERIES** FACE TO FACE MOUNTING (SPACE SAVER)

omniKlip™

BACK TO BACK MOUNTING WITH 40MM FAN

**OMNI-UNI-32-L SERIES**



omniKlip™



**OMNI-UNI-41-L SERIES** FACE TO FACE MOUNTING (SPACE SAVER)

omniKlip™

BACK TO BACK MOUNTING WITH 60MM FAN

**OMNI-UNI-41-L SERIES**



omniKlip™

# EXTRUDED SERIES HEAT SINKS

---

*Extruded Heat Sinks For Power Semiconductors* ..... 88-92

*Performance, Low Profile Heat Sinks For Power Modules & IGBT's* ..... 93

*Extruded Heat Sinks For DC/DC Converters* ..... 94-96

*Mounting Hardware For Extruded Heat Sinks* ..... 95



---

*For cooling single and multiple high power devices packaged in industry standard semiconductor case styles: TO-3 to TO-247, DO-4 to DO-30, hex-type, and stud mount; press pack devices; power modules; SCRs, IGBTs; I/O devices; and other isolated flat base devices in both natural and forced convection.*

## EXTRUDED HEAT SINKS FOR POWER SEMICONDUCTORS

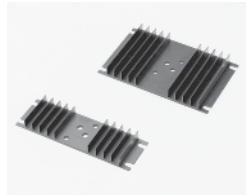

### 621 & 623 SERIES

LOW-PROFILE HEAT SINKS FOR ALL METAL-CASE  
POWER SEMICONDUCTORS

TO-3

A general purpose yet efficient heat dissipator for TO-3 and virtually all other styles of metal case power semiconductor package types, the **621 and 623 Series** low-profile flat back heat sinks find a wide variety of applications. The central channel between fins measures 1.300 in. (33.0) (min.) in width, accommodating many types of packages. Mounting hole pattern "A" is pre-drilled for the standard TO-3 package.

Standard P/N	Footprint Dimensions in. (mm)	Height in. (mm)	Mounting Hole Pattern	Thermal Performance at Typical Load		Weight lbs. (grams)
				Natural Convection	Forced Convection	
621A	4.750 (120.6) x 1.500 (38.1)	0.461 (11.7)	(1) TO-3	75°C @ 15W	2.0°C/W @ 250 LFM	0.1000 (45.36)
621K	4.750 (120.6) x 1.500 (38.1)	0.461 (11.7)	None	75°C @ 15W	2.0°C/W @ 250 LFM	0.1000 (45.36)
623A	4.750 (120.6) x 3.000 (76.2)	0.461 (11.7)	(1) TO-3	52°C @ 15W	1.5°C/W @ 250 LFM	0.2100 (95.26)
623K	4.750 (120.6) x 3.000 (76.2)	0.461 (11.7)	None	52°C @ 15W	1.5°C/W @ 250 LFM	0.2100 (95.26)

Material: Aluminum Alloy, Black Anodized.

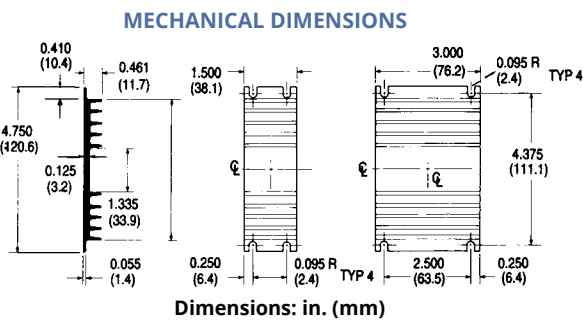

(EXTRUSION PROFILE 1327)

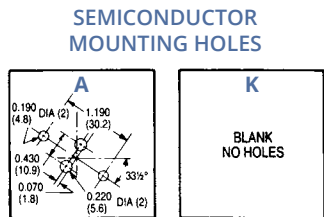

### NATURAL AND FORCED CONVECTION CHARACTERISTICS

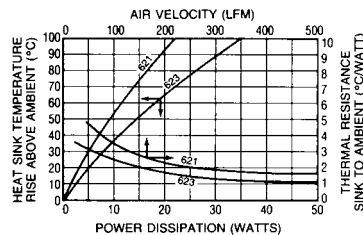

## COMPACT HEAT SINKS FOR DUAL STUD-MOUNTED SEMICONDUCTOR CASES

### 301, 302, & 303 SERIES

Stud-Mount

The large fin area in minimum total volume provided by the radial design of the **301/302/303 Series** offers maximum heat transfer efficiency in natural convection. All types are available with one tapped mounting hole for rectifiers and other stud-mounting semiconductors; the 302 and 303 Series offer maximum cost savings with dual mounting locations ("MM" and "NN" mounting hole patterns) for two stud-mount devices.

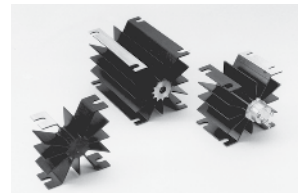

Standard P/N	Outline Dimensions in. (mm)	Length "A" in. (mm)	Mounting Hole(s) Pattern and Number	Thermal Performance at Typical Load		Weight lbs. (grams)
				Natural Convection	Forced Convection	
301K	2.000 (50.8) x 2.000 (50.8)	0.750 (19.1)	None	70°C @ 15W	2.5°C/W @ 250 LFM	0.0580 (26.31)
301M	2.000 (50.8) x 2.000 (50.8)	0.750 (19.1)	(1) 10-32UNF, 0.625 in. thread depth	70°C @ 15W	2.5°C/W @ 250 LFM	0.0580 (26.31)
301N	2.000 (50.8) x 2.000 (50.8)	0.750 (19.1)	(1) 1/4 -28UNF, 0.625 in. thread depth	70°C @ 15W	2.5°C/W @ 250 LFM	0.0580 (26.31)
302M	2.000 (50.8) x 2.000 (50.8)	1.500 (38.1)	(1) 10-32UNF, 0.625 in. thread depth	50°C @ 15W	1.8°C/W @ 250 LFM	0.1330 (60.33)
302MM	2.000 (50.8) x 2.000 (50.8)	1.500 (38.1)	(2) 10-32UNF, 0.625 in. thread depth	50°C @ 15W	1.8°C/W @ 250 LFM	0.1330 (60.33)
302N	2.000 (50.8) x 2.000 (50.8)	1.500 (38.1)	(1) 1/4 -28UNF, 0.625 in. thread depth	50°C @ 15W	1.8°C/W @ 250 LFM	0.1330 (60.33)
302NN	2.000 (50.8) x 2.000 (50.8)	1.500 (38.1)	(2) 1/4 -28UNF, 0.625 in. thread depth	50°C @ 15W	1.8°C/W @ 250 LFM	0.1330 (60.33)
303M	2.000 (50.8) x 2.000 (50.8)	3.000 (76.2)	(1) 10-32UNF, 0.625 in. thread depth	37°C @ 15W	1.3°C/W @ 250 LFM	0.2680 (121.56)
303MM	2.000 (50.8) x 2.000 (50.8)	3.000 (76.2)	(2) 10-32UNF, 0.625 in. thread depth	37°C @ 15W	1.3°C/W @ 250 LFM	0.2680 (121.56)
303N	2.000 (50.8) x 2.000 (50.8)	3.000 (76.2)	(1) 1/4 -28UNF, 0.625 in. thread depth	37°C @ 15W	1.3°C/W @ 250 LFM	0.2680 (121.56)
303NN	2.000 (50.8) x 2.000 (50.8)	3.000 (76.2)	(2) 1/4 -28UNF, 0.625 in. thread depth	37°C @ 15W	1.3°C/W @ 250 LFM	0.2680 (121.56)

Material: Aluminum Alloy, Black Anodized.

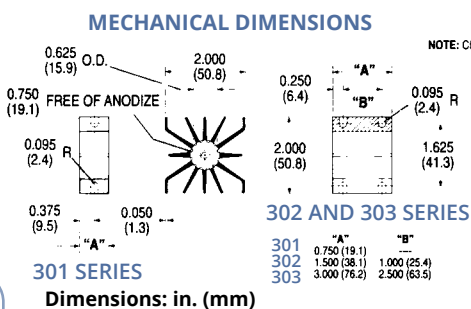

NOTE: CROSS-HATCHED AREAS FREE OF ANODIZE.

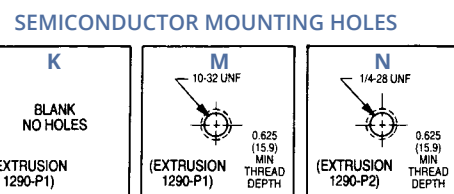

### NATURAL AND FORCED CONVECTION CHARACTERISTICS

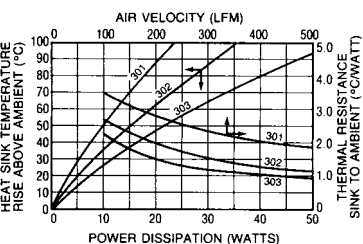

## DOUBLE-SURFACE HEAT SINKS FOR TO-3 CASE STYLES

### 401 & 403 SERIES

TO-3; Stud-Mount

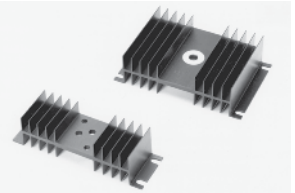

With fins oriented vertically in cabinet sidewall applications, **401 and 403 Series** heat sinks are recommended for critical space applications where maximum heat dissipation is required for high-power TO-3 case styles. Forced convection performance is also exemplary with these double surface fin types. Semiconductor mounting hole style "F" offers a single centered 0.270 in. (6.9)-diameter mounting hole (with a 0.750 in. (19.1)-diameter area free of anodize) for mounting stud-type diodes and rectifiers. Hole pattern "V" available upon request.

Standard P/N	Width in. (mm)	Overall Dimensions in. (mm)	Height in. (mm)	Semiconductor Mounting Hole Pattern	Thermal Performance at Typical Load		Weight lbs. (grams)
					Natural Convection	Forced Convection	
401A	4.750 (120.7)	1.500 (38.1)	1.250 (31.8)	(1) TO-3	80°C @ 30W	1.5°C/W @ 250 LFM	0.1500 (68.04)
401F	4.750 (120.7)	1.500 (38.1)	1.250 (31.8)	0.270 in. (6.9)-Dia Hole	80°C @ 30W	1.5°C/W @ 250 LFM	0.1500 (68.04)
401K	4.750 (120.7)	1.500 (38.1)	1.250 (31.8)	None	80°C @ 30W	1.5°C/W @ 250 LFM	0.1500 (68.04)
403A	4.750 (120.7)	3.000 (76.2)	1.250 (31.8)	(1) TO-3	55°C @ 30W	0.9°C/W @ 250 LFM	0.3500 (158.76)
403F	4.750 (120.7)	3.000 (76.2)	1.250 (31.8)	0.270 in. (6.9)-Dia Hole	55°C @ 30W	0.9°C/W @ 250 LFM	0.3500 (158.76)
403K	4.750 (120.7)	3.000 (76.2)	1.250 (31.8)	None	55°C @ 30W	0.9°C/W @ 250 LFM	0.3500 (158.76)

Material: Aluminum Alloy, Black Anodized.

### MECHANICAL DIMENSIONS

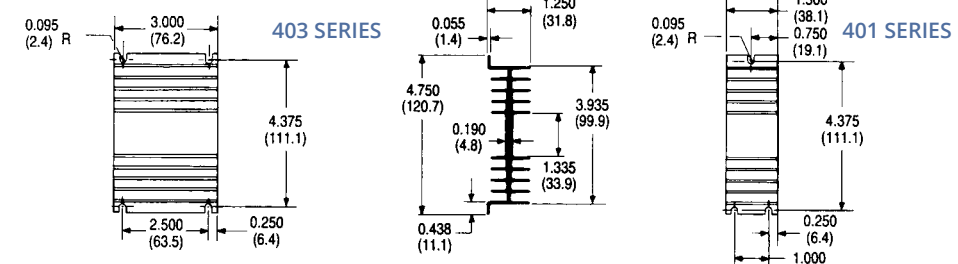

Dimensions: in. (mm)

### SEMICONDUCTOR MOUNTING HOLES

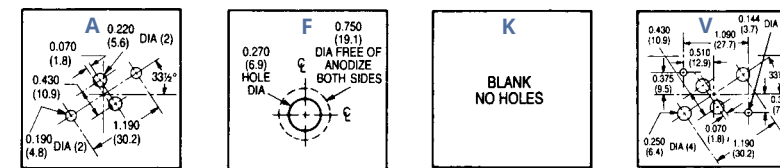

### NATURAL AND FORCED CONVECTION CHARACTERISTICS

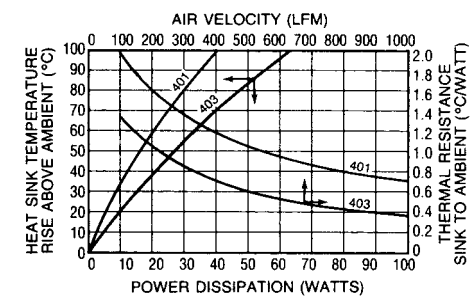

(EXTRUSION PROFILE 1024)

### 441 SERIES

## HIGH-PERFORMANCE NATURAL CONVECTION HEAT SINKS FOR RECTIFIERS AND DIODES

Stud-Mount

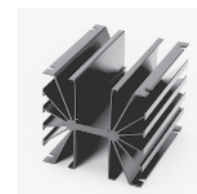

Designed for vertical mounting within a power supply enclosure or equipment cabinet without forced airflow available. This Wakefield-Vette **441 Series** heat sink will dissipate up to 100 watts efficiently in natural convection with a maximum 55°C heat sink temperature rise above ambient. When applied in a forced convection environment, the 441K Type will achieve thermal resistance of 0.18°C/W (sink to ambient) at 1000 LFM. Supplied with no pre-drilled device mounting hole pattern.

Standard P/N	Nominal Dimensions			Semiconductor Mounting Hole Pattern	Thermal Performance at Typical Load		Weight lbs. (grams)
	Width in. (mm)	Length in. (mm)	Height in. (mm)		Natural Convection	Forced Convection	
441K	4.750 (120.7)	5.500 (139.7)	4.500 (114.3)	None	34°C @ SOW 47°C @ 80W	0.30°C/W @ 250 LFM 0.19°C/W @ 600 LFM	1.9700 (893.59)

Material: Aluminum Alloy, Black Anodized.

### MECHANICAL DIMENSIONS

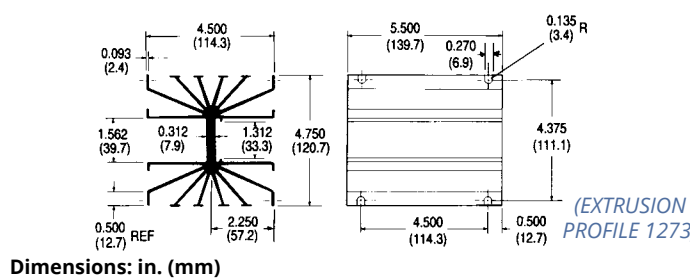

Dimensions: in. (mm)

### SEMICONDUCTOR MOUNTING HOLE

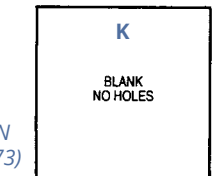

### NATURAL AND FORCED CONVECTION CHARACTERISTICS

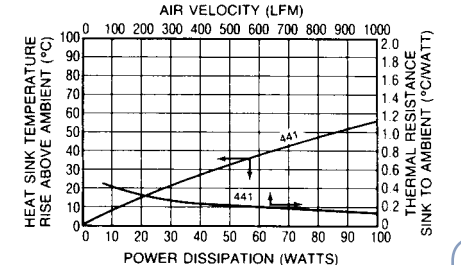



## EXTRUDED HEAT SINKS FOR POWER SEMICONDUCTORS

### 413, 421, & 423 SERIES

LOW-HEIGHT DOUBLE-SURFACE HEAT SINKS FOR TO-3 CASE STYLES AND DIODES

TO-3; DO-5; Stud-Mount

Space-saving double surface **413, 421, and 423 Series** utilize finned surface area on both sides of the power semiconductor mounting surface to provide maximum heat dissipation in a compact profile. Ready to install on popular power components in natural and forced convection applications. Apply Wakefield-Vette Type 126 silicone-free thermal compound or Wakefield-Vette DeltaPad™ interface materials for maximum performance.

Standard P/N	Nominal Dimensions			Semiconductor Mounting Hole Pattern	Thermal Performance at Typical Load		Weight lbs. (grams)
	Width in. (mm)	Length in. (mm)	Height "A" in. (mm)		Natural Convection	Forced Convection	
413A	4.750 (120.7)	3.000 (76.2)	1.875 (47.6)	(1) TO-3	72°C @ 50W	0.85°C/W @ 250 LFM	0.6300 (285.77)
413F	4.750 (120.7)	3.000 (76.2)	1.875 (47.6)	0.270 in. (6.9)-Dia Hole	72°C @ 50W	0.85°C/W @ 250 LFM	0.6300 (285.77)
413K	4.750 (120.7)	3.000 (76.2)	1.875 (47.6)	None	72°C @ 50W	0.85°C/W @ 250 LFM	0.6300 (285.77)
421A	4.750 (120.7)	3.000 (76.2)	2.625 (66.7)	(1) TO-3	58°C @ 50W	0.7°C/W @ 250 LFM	0.6300 (285.77)
421F	4.750 (120.7)	3.000 (76.2)	2.625 (66.7)	0.270 in. (6.9)-Dia Hole	58°C @ 50W	0.7°C/W @ 250 LFM	0.6300 (285.77)
421K	4.750 (120.7)	3.000 (76.2)	2.625 (66.7)	None	58°C @ 50W	0.7°C/W @ 250 LFM	0.6300 (285.77)
423A	4.750 (120.7)	5.500 (140.2)	2.625 (66.7)	(1) TO-3	47°C @ 50W	0.5°C/W @ 250 LFM	1.1700 (530.71)
423K	4.750 (120.7)	5.500 (140.2)	2.625 (66.7)	None	47°C @ 50W	0.5°C/W @ 250 LFM	1.1700 (530.71)

Material: Aluminum Alloy, Black Anodized.

#### MECHANICAL DIMENSIONS

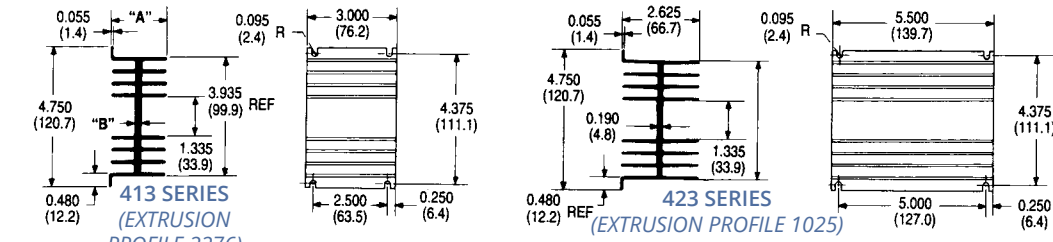

**413 SERIES**  
(EXTRUSION PROFILE 2276)  
**421 SERIES**  
(EXTRUSION PROFILE 1025)

**423 SERIES**  
(EXTRUSION PROFILE 1025)

Dimensions: in. (mm)

#### SEMICONDUCTOR MOUNTING HOLES

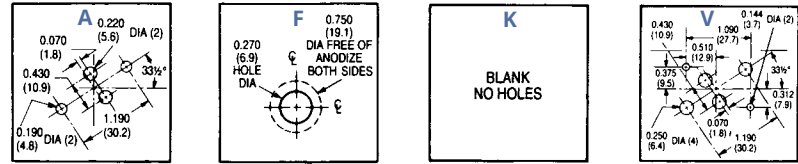

#### NATURAL AND FORCED CONVECTION CHARACTERISTICS

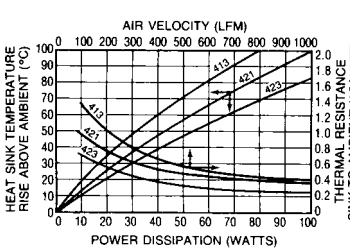

## HIGH-PERFORMANCE HEAT SINKS FOR 30-100W METAL POWER SEMICONDUCTORS

TO-3; Stud-Mount

### 431 & 433 SERIES

Need maximum heat dissipation from a TO-3 rectifier heat sink in minimum space? The Wakefield-Vette **431 and 433 Series** center channel double-surface heat sinks offer the highest performance-to-weight ratio for minimum volume occupied for TO-3, diode, and stud-mount metal power semiconductors in the 30- to 100-watt operating range. Additional interface resistance reduction for maximized overall performance can be achieved with proper application of Wakefield-Vette Type 126 silicone-free thermal compound.

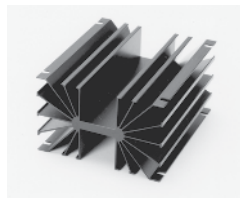

Standard P/N	Nominal Dimensions			Semiconductor Mounting Hole Pattern	Thermal Performance at Typical Load		Weight lbs. (grams)
	Width in. (mm)	Length "A" in. (mm)	Height in. (mm)		Natural Convection	Forced Convection	
431K	4.750 (120.7)	3.000 (76.2)	3.000 (76.2)	None	55°C @ 50W	0.40°C/W @ 250 LFM	0.7800 (353.81)
433K	4.750 (120.7)	5.500 (139.7)	3.000 (76.2)	None	42°C @ 50W	0.28°C/W @ 250 LFM	1.4900 (675.86)

Material: Aluminum Alloy, Black Anodized.

#### MECHANICAL DIMENSIONS

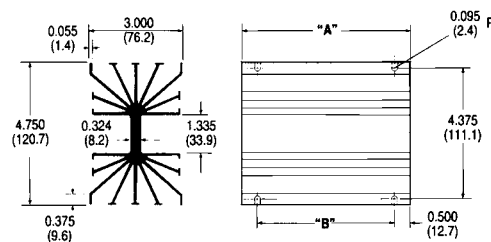

90

**431 SERIES**  
**433 SERIES**

SEMICONDUCTOR MOUNTING HOLE

(EXTRUSION PROFILE 2726)

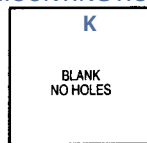

#### NATURAL AND FORCED CONVECTION CHARACTERISTICS

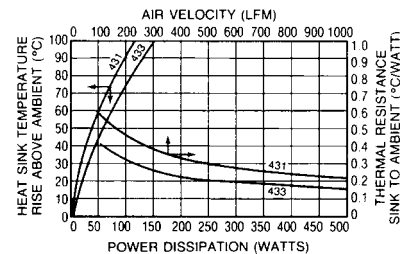

## LIGHTWEIGHT QUADRUPLE MOUNT HEAT SINK FOR TO-3 CASE STYLES

### 435 SERIES

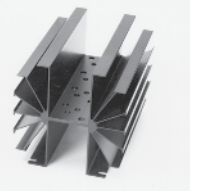

TO-3

This lightweight high-performance heat sink is designed to mount and cool efficiently one to four TO-3 style metal case power semiconductors. The Type 435AAAA is the standard configuration available from stock, pre-drilled for mounting four TO-3 style devices. Increased performance can be achieved with the proper selection and installation of a Wakefield-Vette Type 175 DeltaPad Kapton™ interface material for each power semiconductor or, for maximum reduction of case-to-sink interface loss, the application of Wakefield-Vette Type 126 silicone-free thermal compound.

Standard P/N	Nominal Dimensions			Semiconductor Mounting Hole Pattern	Thermal Performance at Typical Load		Weight lbs. (grams)
	Width in. (mm)	Length in. (mm)	Height in. (mm)		Natural Convection	Forced Convection	
435AAAA	4.250 (108.0)	5.500 (139.7)	4.300 (109.2)	(4) TO-3	37°C @ 50W 54°C @ 80W	0.38°C/W @ 250 LFM 0.24°C/W @ 600 LFM	1.1500 (521.64)

Material: Aluminum Alloy, Black Anodized.

#### MECHANICAL DIMENSIONS

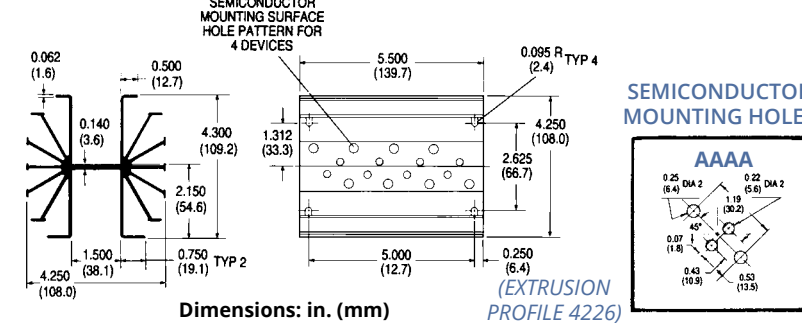

Dimensions: in. (mm)

(EXTRUSION PROFILE 4226)

#### NATURAL AND FORCED CONVECTION CHARACTERISTICS

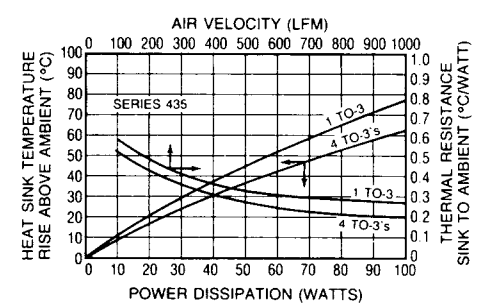

### 486 & 489 SERIES

HEAT SINKS FOR HIGH-POWER HEX-TYPE RECTIFIERS AND DIODES

Stud-Mount

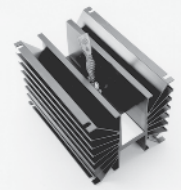

These two heat sink types accept industry standard 1.750 in. (44.5) hex-type devices for mounting and efficient heat dissipation. Each type is provided with a 1.750 in. (44.5) x 2.000 in. (50.8) area on the semiconductor base mounting surface which is free of anodize.

Standard P/N	Nominal Dimensions			Hex Style Type	Mounting Hole Pattern	Thermal Performance at Typical Load		Weight lbs. (grams)
	Width in. (mm)	Length in. (mm)	Height in. (mm)			Natural Convection	Forced Convection	
486K	6.250 (158.8)	6.000 (152.4)	6.250 (158.8)	1.750 in. Hex	None	24°C @ 50W 86°C @ 250W	0.20°C/W @ 250 LFM 0.13°C/W @ 500 LFM	4.2100 (1909.66)
489K	6.250 (158.8)	9.000 (228.6)	6.250 (158.8)	1.750 in. Hex	None	19°C @ 50W 75°C @ 250W	0.15°C/W @ 250 LFM 0.10°C/W @ 500 LFM	6.1400 (2785.10)

Material: Aluminum Alloy, Black Anodized.

#### MECHANICAL DIMENSIONS

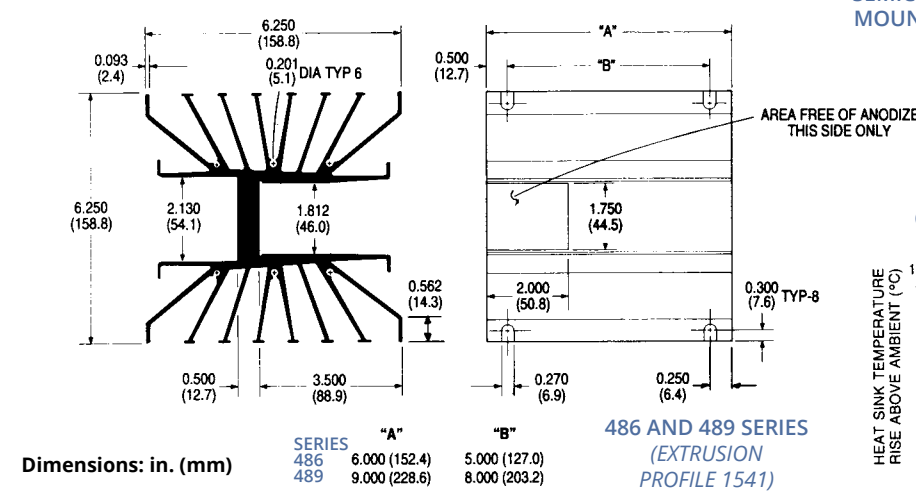

Dimensions: in. (mm)

**486 AND 489 SERIES**  
(EXTRUSION PROFILE 1541)

#### SEMICONDUCTOR MOUNTING HOLE



#### NATURAL AND FORCED CONVECTION CHARACTERISTICS

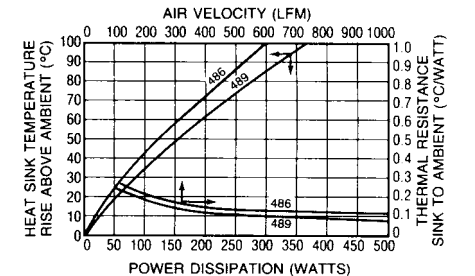

91

## EXTRUDED HEAT SINKS FOR POWER SEMICONDUCTORS

### 465 & 476 SERIES

HIGH-POWER HEAT SINKS FOR MEDIUM  
HEX-TYPE RECTIFIERS AND DIODES

Stud-Mount

Wakefield-Vette Engineering has designed four standard heat sink types for ease of installation and efficient heat dissipation for industry standard hex-type rectifiers and similar stud-mount power devices: 465, 476, 486, and 489 Series. The **465 and 476 Series** shown here are designed for 1.060 in. Hex (465 Type) and 1.250 in. Hex (476 Type). The 476W Type is available pre-drilled for an 0.765 in. (19.4) dia,

Standard P/N	Nominal Dimensions			Hex Style		Thermal Performance at Typical Load		Weight lbs. (grams)
	Width in. (mm)	Length in. (mm)	Height in. (mm)	Hex Style Type	Mounting Hole Pattern	Natural Convection	Forced Convection	
465K	4.000 (101.6)	5.000 (127.0)	4.000 (101.6)	1.060 in. Hex	None	38°C @ 50W	0.27°C/W @ 500 LFM	1.9300 (875.45)
476K	5.000 (127.0)	6.000 (152.4)	5.000 (127.0)	1.250 in. Hex	None	25°C @ 50W	0.19°C/W @ 500 LFM	2.8200 (1279.15)
476W	5.000 (127.0)	6.000 (152.4)	5.000 (127.0)	1.250 in. Hex	0.765 in. (19.4) Dia. Center Mount	25°C @ 50W	0.19°C/W @ 500 LFM	2.8000 (1270.08)

**Material:** Aluminum Alloy, Black Anodized.

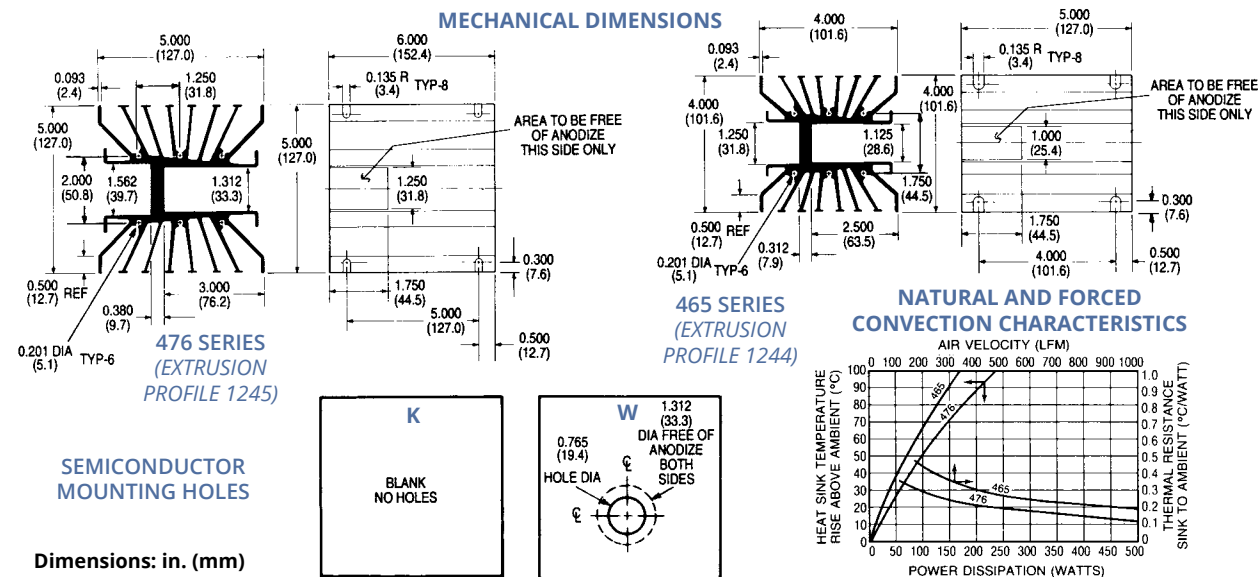

### KING SIZE HEAT SINKS FOR HIGH-POWER RECTIFIERS

### 490 SERIES

General Purpose

The **490 Series** can be used to mount a single high-power rectifier or a grouping of smaller power devices. The semiconductor device mounting surface is free of anodize on the entire surface on one side only; finish overall is black anodize. Use Type 109 mounting brackets (see accessories section) for mounting to enclosure wall and for electrical isolation. The anodize-free mounting surface is milled for maximum contact area. The 490 Series Can also be drilled for mounting and cooling IGBTs and other isolated power modules.

Standard P/N	Nominal Dimensions			Semiconductor Mounting Hole Pattern	Thermal Performance at Typical Load		Weight lbs. (grams)
	Width in. (mm)	Length "A" in. (mm)	Height in. (mm)		Natural Convection	Forced Convection	
490-35K	9.250 (235.0)	3.500 (88.9)	6.750 (171.5)	None	84°C @ 200W	0.18°C/W @ 600 LFM	3.2400 (1469.66)
490-6K	9.250 (235.0)	6.000 (152.4)	6.750 (171.5)	None	60°C @ 200W	0.13°C/W @ 600 LFM	5.4700 (2481.19)
490-12K	9.250 (235.0)	12.000 (304.8)	6.750 (171.5)	None	45°C @ 200W	0.09°C/W @ 600 LFM	10.6200(4817.23)

**Material:** Aluminum Alloy, Black Anodized.

### MECHANICAL DIMENSIONS

#### 490 SERIES (EXTRUSION PROFILE 2131)

Dimensions: in. (mm)

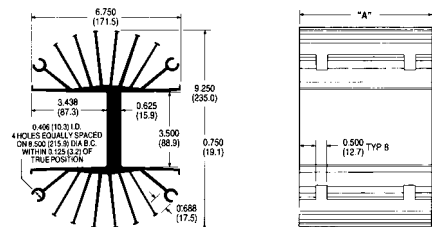

### SEMICONDUCTOR MOUNTING HOLE

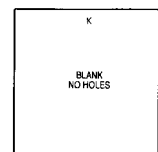

### NATURAL AND FORCED CONVECTION CHARACTERISTICS

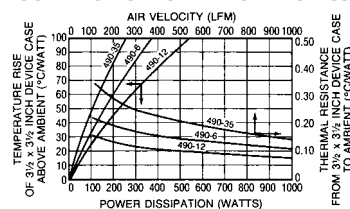

## PERFORMANCE, LOW PROFILE HEAT SINKS FOR POWER MODULES & IGBT'S

### 394, 395, & 396 SERIES

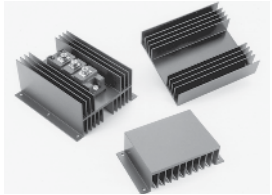

Standard P/N	Overall Dimensions: in. (mm)			Device Base Mounting Area (mm)	Base Mounting Holes	Thermal Resistance at Typical Load	
	Length in. (mm)	Height in. (mm)	Width in. (mm)			Natural Convection (θsa) <sup>(1)</sup> (°C/W)	Forced Convection (θsa) (°C/W @ 500 LFM)
394-1AB	3.000 (76.2)	1.500 (38.1)	5.000 (127.0)	101 x 76	4	1.85	0.90
394-2AB	5.500 (139.7)	1.500 (38.1)	5.000 (127.0)	101 x 139	6	1.51	0.60
395-1AB	3.000 (76.2)	2.500 (63.5)	5.000 (127.0)	50 x 76	4	1.10	0.50
395-2AB	5.500 (139.7)	2.500 (63.5)	5.000 (127.0)	50 x 139	6	0.90	0.32
396-1AB	3.000 (76.2)	1.380 (35.1)	5.000 (127.0)	50 x 76	4	1.85	1.07
396-2AB	5.500 (139.7)	1.380 (35.1)	5.000 (127.0)	50 x 139	6	1.51	0.64

**Note:** 1. Thermal resistance values shown are for black anodized finish at 50°C rise above ambient.

### MECHANICAL DIMENSIONS

#### 394 SERIES (EXTRUSION PROFILE 7332)

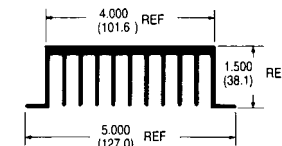
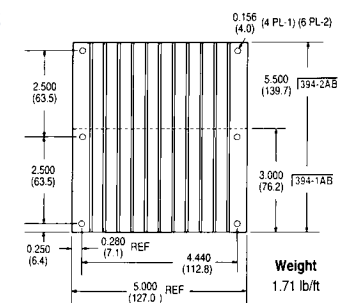

Weight 1.71 lb/ft

### NATURAL AND FORCED CONVECTION CHARACTERISTICS

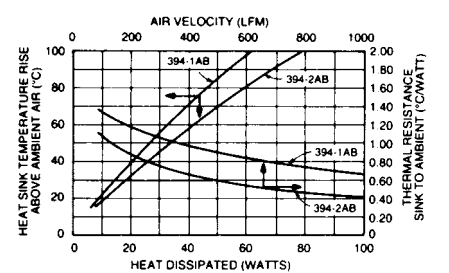

#### 395 SERIES (EXTRUSION PROFILE 7330)

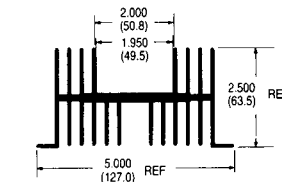
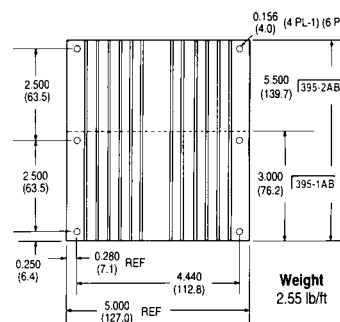

Weight 2.55 lb/ft

### NATURAL AND FORCED CONVECTION CHARACTERISTICS

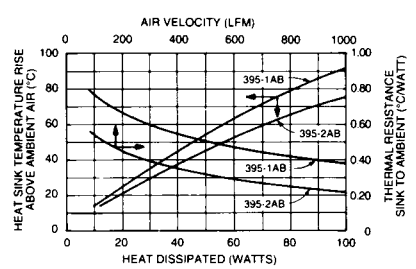

#### 396 SERIES (EXTRUSION PROFILE 7331)

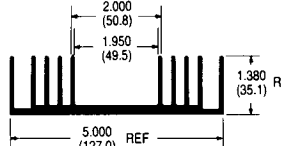
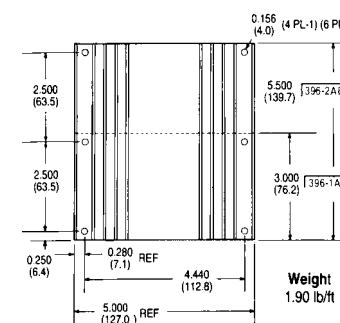

Weight 1.90 lb/ft

### NATURAL AND FORCED CONVECTION CHARACTERISTICS

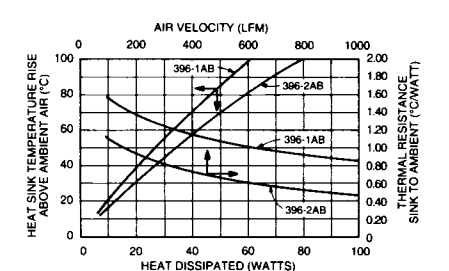



## EXTRUDED HEAT SINKS FOR DC/DC CONVERTERS

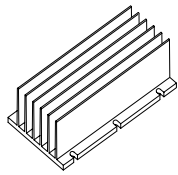

### 557, 558, & 559 SERIES

HEAT SINKS FOR "FULL-BRICK"  
DC/DC CONVERTERS

TO-220 and TO-218

#### FEATURES AND BENEFITS

- Standard mounting hole pattern mates with Vicor DC/DC converters.
- Aluminum extruded fin construction keeps DC/DC converter modules cool in both forced and natural convection applications.
- Three fin heights, two flow direction options.
- Black anodized finish standard.
- Integral thermal interface pad option eliminates need to order and install pad separately.
- Ordering a single part number with the hardware kit option provides everything necessary to keep your converter cool.

Standard P/N	Footprint Dimensions in. (mm)	Height in. (mm)	Fin Orientation	Number of Fins	Forced Convection Thermal Resistance at 300 ft/min (C/W)	Natural Convection Power Dissipation (Watts) 40°C Rise Heat Sink to Ambient
557-140AB	4.60 (116.8) x 2.40 (61.0)	1.40 (35.6)	Horizontal	6	1.3	14
558-75AB	2.40 (61.0) x 4.60 (116.8)	0.75 (19.1)	Vertical	16	1.8	12
559-50AB	2.40 (61.0) x 4.60 (116.8)	0.50 (12.7)	Vertical	27	2.2	10

Material: Aluminum, Black Anodized

#### MECHANICAL DIMENSIONS

##### PRODUCT DESIGNATION

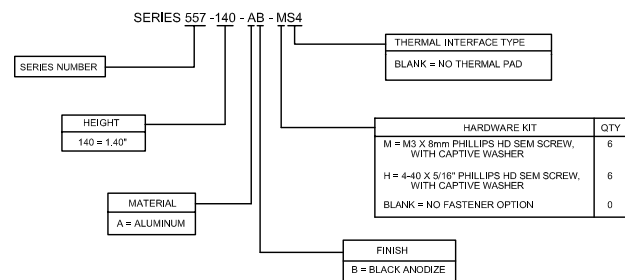

##### 557 SERIES DIMENSIONS

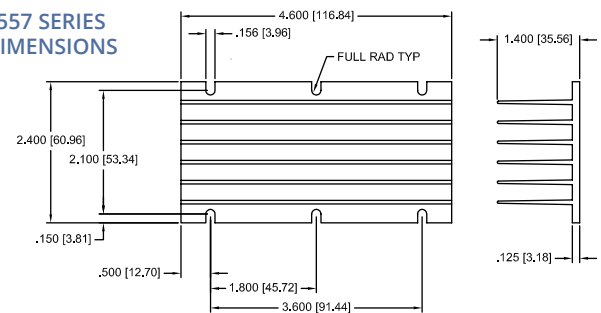

#### MECHANICAL DIMENSIONS

##### PRODUCT DESIGNATION

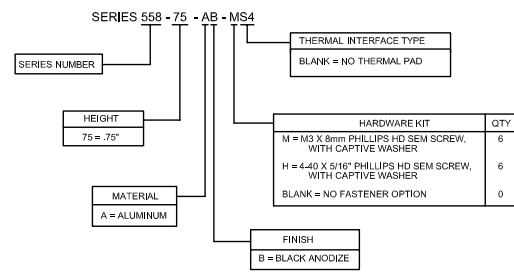

##### 558 SERIES DIMENSIONS

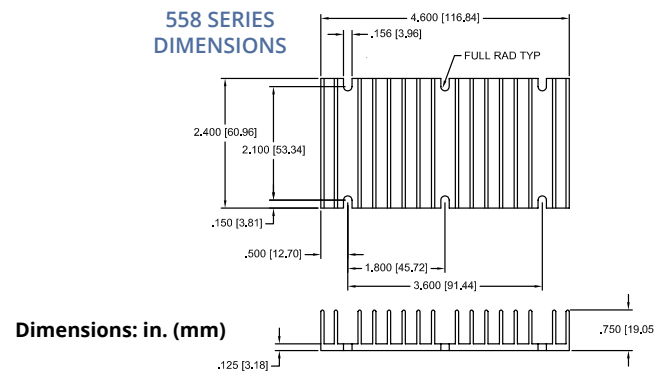

#### MECHANICAL DIMENSIONS

##### PRODUCT DESIGNATION

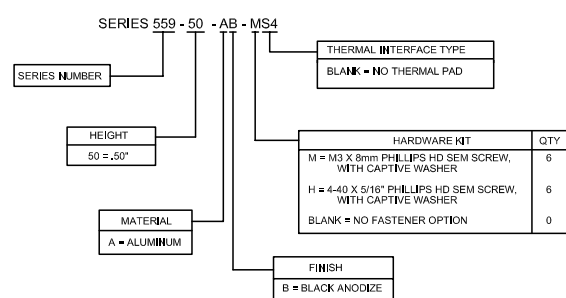

Dimensions: in. (mm)

##### 559 SERIES DIMENSIONS

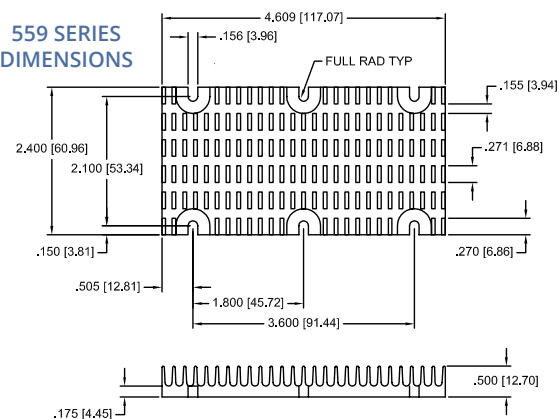

HEAT SINKS FOR "HALF-BRICK"  
DC/DC CONVERTERS

### 517, 527, 518, & 528 SERIES

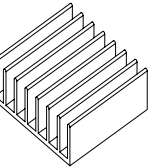

TO-220 and TO-218

#### FEATURES AND BENEFITS

- Standard mounting hole patterns mate with the majority of "half-brick" DC/DC converters on the market.
- Aluminum extruded fin construction keeps DC/DC converter modules cool in both forced and natural convection applications.
- Vertical and horizontal fin configurations available in a variety of heights.
- Black anodized finish standard.
- Integral thermal interface pad option eliminates need to order and install pad separately.
- Ordering a single part number with the hardware kit option provides everything necessary to keep your converter cool.

Standard P/N	Footprint Dimensions in. (mm)	Height in. (mm)	Fin Orientation	Number of Fins	Thermal Performance	
					Natural Convection Power Dissipation (Watts) 60°C Rise Heat Sink to Ambient	Forced Convection Thermal Resistance at 300 ft/min (C/W)
517-95AB	2.28 (57.9) x 2.40 (61.0)	0.95 (24.1)	Horizontal	8	11W	2.0
527-45AB	2.28 (57.9) x 2.40 (61.0)	0.45 (11.4)	Horizontal	11	7W	3.2
527-24AB	2.28 (57.9) x 2.40 (61.0)	0.24 (6.1)	Horizontal	11	5W	5.8
518-95AB	2.40 (61.0) x 2.28 (57.9)	0.95 (24.1)	Vertical	8	11W	2.0
528-45AB	2.40 (61.0) x 2.28 (57.9)	0.45 (11.4)	Vertical	11	7W	3.2
528-24AB	2.40 (61.0) x 2.28 (57.9)	0.24 (6.1)	Vertical	11	5W	5.8

Material: Aluminum, Black Anodized

#### MECHANICAL DIMENSIONS

##### PRODUCT DESIGNATION

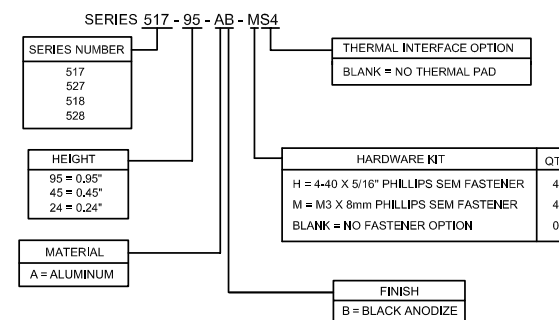

##### 517/527 SERIES DIMENSIONS

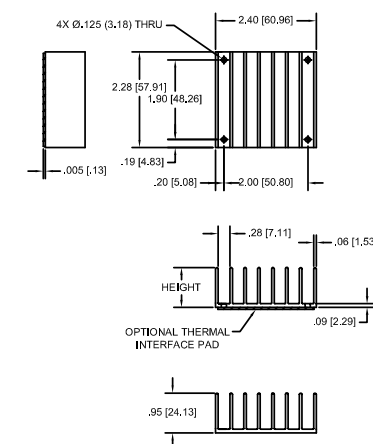

##### 518/528 SERIES DIMENSIONS

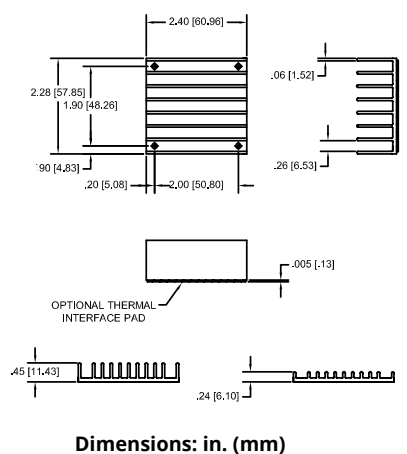

## MOUNTING HARDWARE FOR EXTRUDED HEAT SINKS

### 100 SERIES

TEFLON MOUNTING INSULATORS

Standard P/N	Description	For Use with Series	Mounting Hardware	Material	Hipot Rating (VAC)	Weight lbs. (grams)
103	Spool-shaped insulator	300, 400, 600, 111, 113	#6-32 screw	Teflon	1500	0.00012 (0.05)
107	Spool-shaped insulator	300, 400, 600, 111, 113	#6-32 screw, nut	Teflon	5000	0.0034 (1.54)

#### 103 SERIES

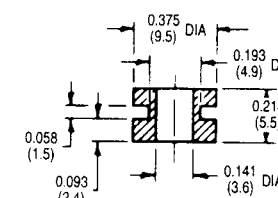
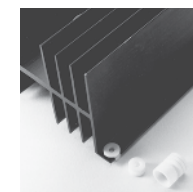

#### 107 SERIES

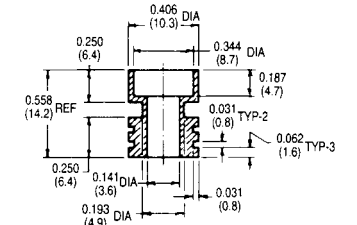
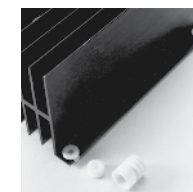



## EXTRUDED HEAT SINKS FOR DC/DC CONVERTERS

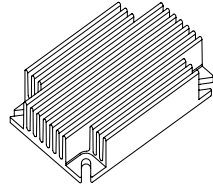

### 537 & 547 SERIES

HEAT SINKS FOR "QUARTER-BRICK"  
DC/DC CONVERTERS

TO-220 and TO-218

#### FEATURES AND BENEFITS

- Mounting slots accommodate two hole patterns: 1.86" x 1.03" and 2.00" x 1.20", fitting the vast majority of quarter-brick converters on the market.
- Designed for optimum use in forced convection applications.
- Vertical and horizontal fin configurations available in a variety of heights.
- Black anodized finish standard.
- Integral thermal interface pad option eliminates need to order and install pad separately.
- Ordering a single part number with the hardware kit option provides everything necessary to keep your converter cool.

Standard P/N	Footprint Dimensions in. (mm)	Height in. (mm)	Fin Orientation	Number of Fins	Forced Convection Thermal Resistance at 300 ft/min (C/W)
537-95AB	2.28 (57.9) x 1.45 (36.8)	0.95 (24.1)	Horizontal	8	2.1
537-45AB	2.28 (57.9) x 1.45 (36.8)	0.45 (11.4)	Horizontal	13	2.3
537-24AB	2.28 (57.9) x 1.45 (36.8)	0.24 (6.1)	Horizontal	14	4.2
547-95AB	1.45 (36.8) x 2.28 (57.9)	0.95 (24.1)	Vertical	11	2.2
547-45AB	1.45 (36.8) x 2.28 (57.9)	0.45 (11.4)	Vertical	20	2.1
547-24AB	1.45 (36.8) x 2.28 (57.9)	0.24 (6.1)	Vertical	22	3.5

Material: Aluminum, Black Anodized

#### MECHANICAL DIMENSIONS

##### 537 SERIES DIMENSIONS

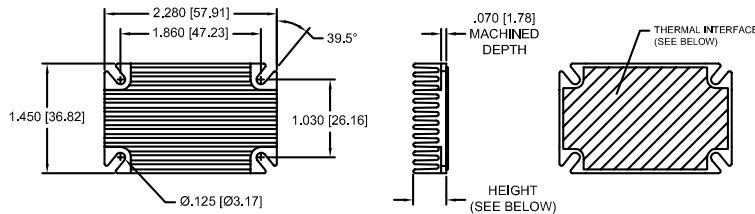

Dimensions: in. (mm)

##### 547 SERIES DIMENSIONS

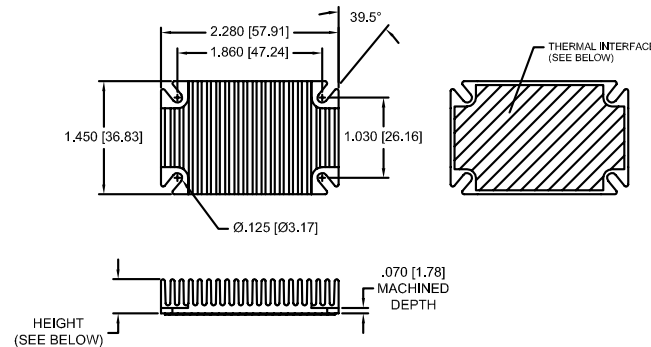

#### PRODUCT DESIGNATION

SERIES 537 - 95 - AB - MS4

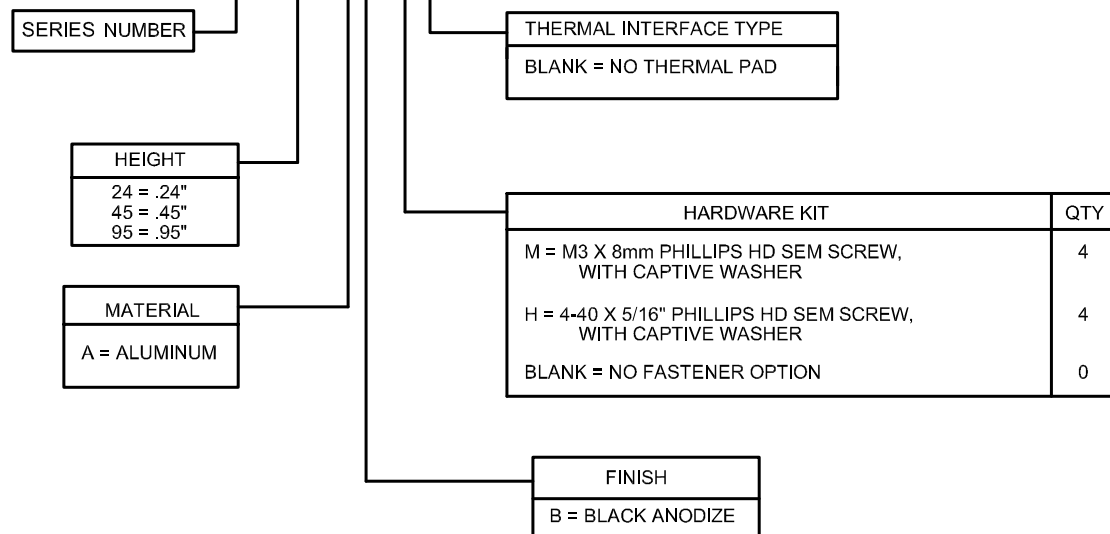

# BONDED FIN HEAT SINKS

---

<i>High Fin Density Heat Sinks for Power Modules, IGBTs, Relays</i> .....	100-101
<i>Custom Bonded Fin Heat Sinks &amp; Assemblies</i> .....	102
<i>maxiTHERM-HD<sup>3</sup>™ Bonded Fin Forced Convection Series #1</i> .....	103
<i>maxiTHERM-HD<sup>3</sup>™ Bonded Fin Forced Convection Series #2</i> .....	104

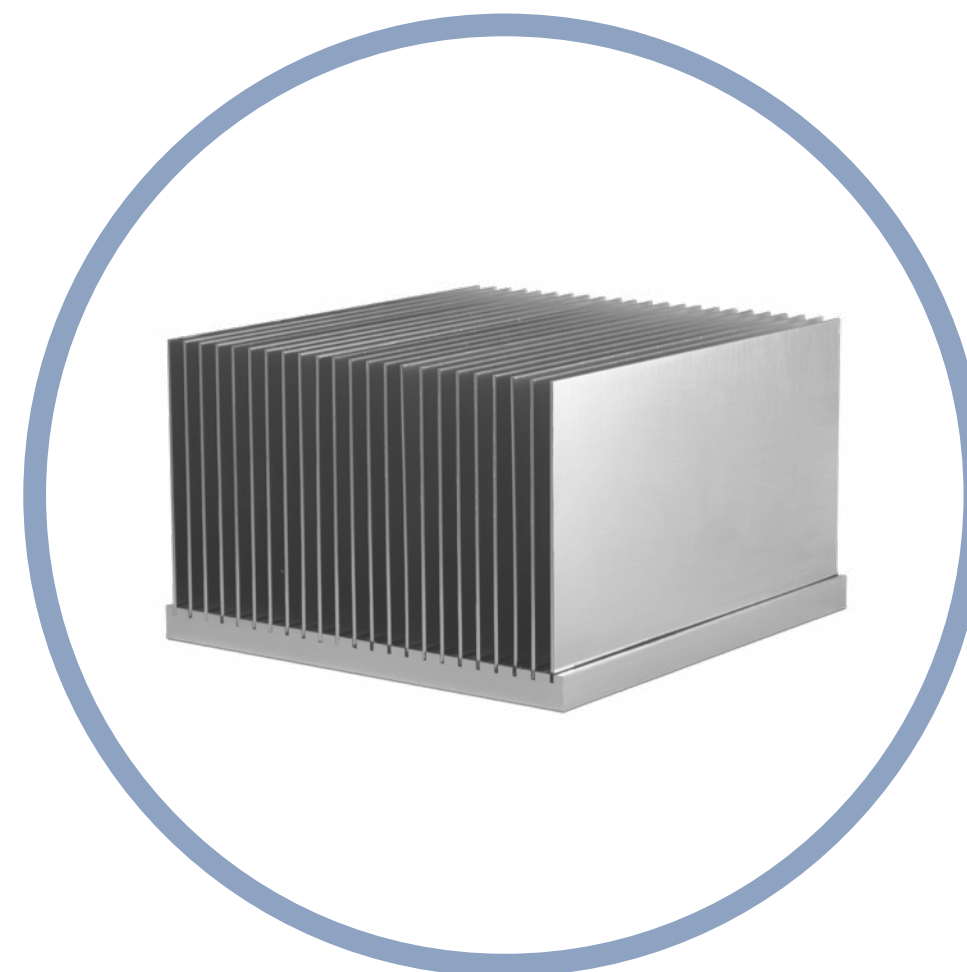

---

*Wakefield-Vette offers a variety of natural and forced convection bonded fin heat sink assemblies. Configurable in a variety of ways, they are reliable, cost effective, and highly efficient thermal management solutions for high power and densely packaged applications, even in demanding shock and vibration environments. Bonded fin heat sinks are used when the required combination of large heat sink size, tall fins and high fin density make simple extrusions impractical.*

*We offer these products in our standard catalog and also custom fabricated to meet a customer's needs.*

# HIGH FIN DENSITY HEAT SINKS FOR POWER MODULES, IGBTs, RELAYS

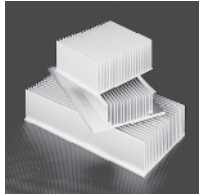

## 510, 511 & 512 SERIES

Standard Catalog P/N <sup>(5)</sup> Milled Base <sup>(1)</sup>	Nonmilled Base <sup>(2)</sup>	Base Width in. (mm)	Length in. (mm)	Height		Thermal Resistance <sup>(5)</sup> ( $\theta_{sa}$ ) at Typical Load	
				Milled Base <sup>(1)</sup> in. (mm)	Nonmilled Base <sup>(2)</sup> in. (mm)	Natural Convection <sup>(3)</sup> (°C/W)	Forced Convection <sup>(4)</sup> (°C/W @ 100 CFM)
510-3M	510-3U	7.380 (187.452)	3.000 (76.2)	3.106 (78.9)	3.136 (79.7)	0.56	0.088
510-6M	510-6U	7.380 (187.452)	6.000 (152.4)	3.106 (78.9)	3.136 (79.7)	0.38	0.070
510-9M	510-9U	7.380 (187.452)	9.000 (228.6)	3.106 (78.9)	3.136 (79.7)	0.29	0.066
510-12M	510-12U	7.380 (187.452)	12.000 (304.8)	3.106 (78.9)	3.136 (79.7)	0.24	0.062
510-14M	510-14U	7.380 (187.452)	14.000 (355.6)	3.106 (78.9)	3.136 (79.7)	0.21	0.059
511-3M	511-3U	5.210 (132.33)	3.000 (76.2)	2.350 (59.7)	2.410 (61.2)	0.90	0.120
511-6M	511-6U	5.210 (132.33)	6.000 (152.4)	2.350 (59.7)	2.410 (61.2)	0.65	0.068
511-9M	511-9U	5.210 (132.33)	9.000 (228.6)	2.350 (59.7)	2.410 (61.2)	0.56	0.060
511-12M	511-12U	5.210 (132.33)	12.000 (304.8)	2.350 (59.7)	2.410 (61.2)	0.45	0.045
512-3M	512-3U	7.200 (182.88)	3.000 (76.2)	2.350 (59.7)	2.410 (61.2)	0.90	0.120
512-6M	512-6U	7.200 (182.88)	6.000 (152.4)	2.350 (59.7)	2.410 (61.2)	0.65	0.068
512-9M	512-9U	7.200 (182.88)	9.000 (228.6)	2.350 (59.7)	2.410 (61.2)	0.56	0.060
512-12M	512-12U	7.200 (182.88)	12.000 (304.8)	2.350 (59.7)	2.410 (61.2)	0.45	0.045

510 SERIES		510 Series (Extrusion Profile 5113)	
Series	A	B	Flatness
510-U	0.216 (5.5)	3.136 (79.7)	0.006 in./in. (0.15 mm/mm)
510-M	0.165 (4.2)	3.106 (78.9)	0.002 in./in. (0.05 mm/mm)

511 AND 512 SERIES		511 Series (Extrusion Profile 6438-1)		512 Series (Extrusion Profile 6438-2)	
Series	A	B	C	Flatness	Flatness
511-U 512-U	0.250 (6.4)	2.410 (61.2)	0.372 (9.4)	0.006 in./in. (0.15 mm/mm)	0.006 in./in. (0.15 mm/mm)
511-M 512-M	0.220 (5.6)	2.350 (59.7)	0.342 (8.7)	0.002 in./in. (0.05 mm/mm)	0.002 in./in. (0.05 mm/mm)

### MECHANICAL DIMENSIONS

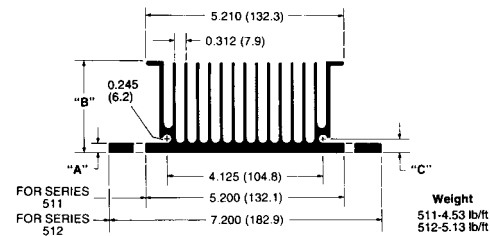
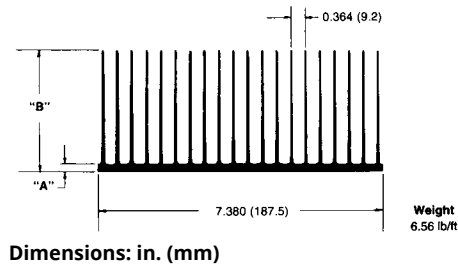

### NATURAL AND FORCED CONVECTION CHARACTERISTICS

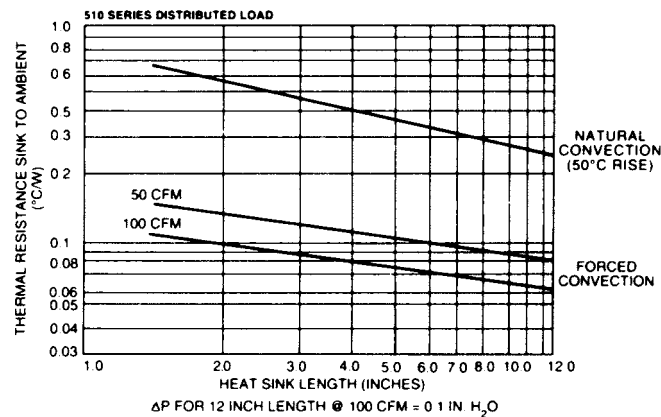

### NATURAL AND FORCED CONVECTION CHARACTERISTICS

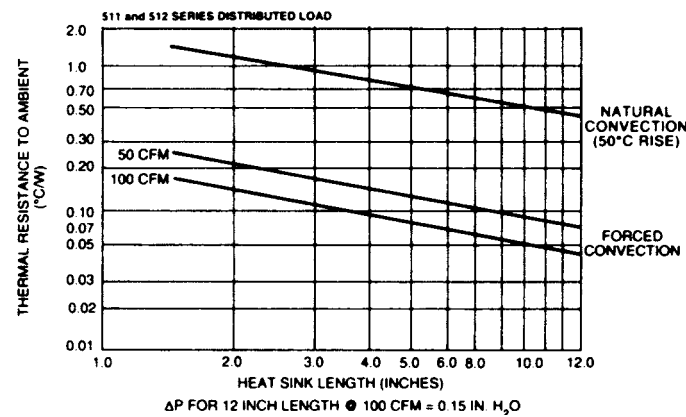

### NOTES:

1. Precision-milled base for maximum heat transfer performance (flatness 0.002 in./in.)
2. Nonmilled base flatness: 0.006 in./in.
3. Natural convection heat dissipation for distributed heat sources at 50°C rise.
4. Forced convection heat dissipation for distributed heat sources at 100 cubic feet per minute, shrouded condition.
5. Standard models are provided without finish.

# HIGH PERFORMANCE HEAT SINKS FOR POWER MODULES, IGBTs AND SOLID STATE RELAYS

## 392 SERIES

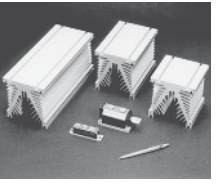

Standard P/N, Finish		Length in. (mm)	Thermal Resistance at Typical Load		Weight lbs. (grams)
Black Anodized	Gold Iridite		Natural Convection ( $\theta_{sa}$ ) (°CW)	Forced Convection ( $\theta_{sa}$ ) (°CW)	
392-120AB	392-120AG	4.725 (120.0)	0.50	0.16 @ 100 CFM	4.452 (2019.43)
392-180AB	392-180AG	7.087 (180.0)	0.43	0.11 @ 100 CFM	6.636 (3010.09)
392-300AB	392-300AG	11.811 (300.0)	0.33	0.08 @ 100 CFM	10.420 (4726.51)

### MECHANICAL DIMENSIONS

#### 392 SERIES (EXTRUSION PROFILE 5658)

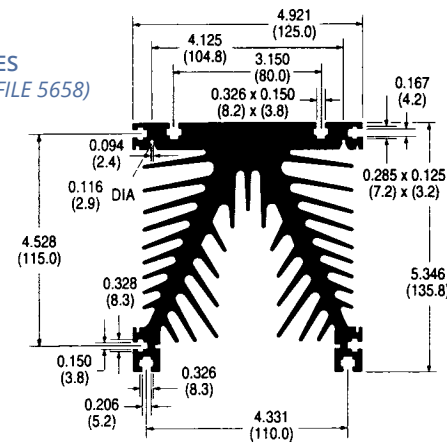

Dimensions: in. (mm)

### NATURAL AND FORCED CONVECTION CHARACTERISTICS

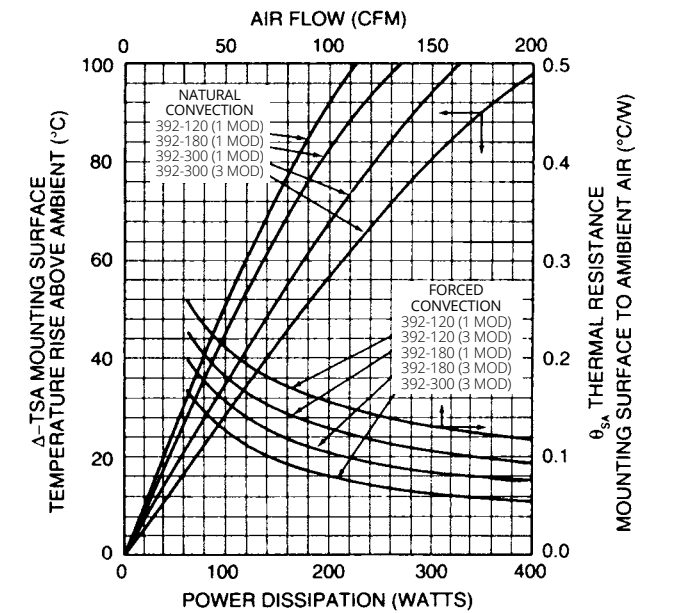



## CUSTOM BONDED FIN HEAT SINKS & ASSEMBLIES

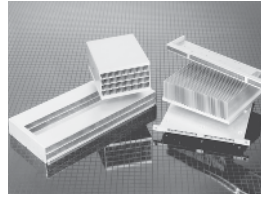

Wakefield-Vette offers an extensive line of natural convection and forced convection custom bonded fin heat sinks assemblies. Configurable in a variety of ways, they are reliable, cost effective, and highly efficient thermal management solutions for high power and densely packaged applications, even in demanding shock and vibration environments.

**MOUNTING LEG**  
(EXTRUSION PROFILE 8930)  
(EXTRUSION PROFILE 8120)

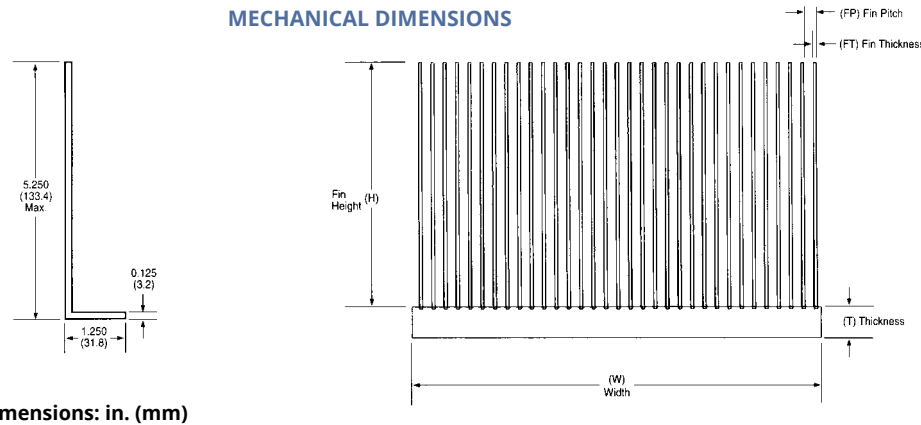

Dimensions: in. (mm)

Base Extrusion Profile No.	BONDED FIN BASES					Thermal Resistance °C/W			
	W	T	FT	FP	Max # Fins	Natural Convection		Forced Convection	
						H = 2"	H = 4"	H = 2"	H = 4"
8711	2.800 (71.1)	0.520 (13.2)	.050 (1.3)	0.275 (5.4)	10	1.360	0.830	0.459	0.277
8731	3.615 (91.8)	0.575 (14.6)	.050 (1.3)	0.239 (6.1)	15	1.110	0.685	0.281	0.168
8546	4.000 (101.6)	0.500 (12.7)	.050 (1.3)	0.200 (5.1)	20	1.330	0.823	0.215	0.144
8737	4.425 (112.4)	0.650 (16.5)	.050 (1.3)	0.238 (6.0)	18	0.937	0.580	0.233	0.140
8119	4.750 (120.7)	0.500 (12.7)	.050 (1.3)	0.288 (7.3)	16	0.880	0.539	0.222	0.157
8712	5.000 (127.0)	0.530 (13.5)	.050 (1.3)	0.198 (5.0)	25	1.122	0.692	0.170	0.101
8732	5.650 (143.5)	0.500 (12.7)	.050 (1.3)	0.200 (5.1)	28	1.011	0.625	0.152	0.090
8556	6.000 (152.4)	0.500 (12.7)	.050 (1.3)	0.250 (6.4)	24	0.751	0.438	0.153	0.107
8542	6.620 (168.1)	0.500 (12.7)	.050 (1.3)	0.200 (5.1)	33	0.880	0.519	0.122	0.082
8671	7.230 (183.6)	0.550 (14.0)	.050 (1.3)	0.239 (6.1)	30	0.655	0.399	0.123	0.086
8823	7.440 (189.0)	0.525 (13.3)	.050 (1.3)	0.200 (5.1)	37	0.820	0.500	0.118	0.070
8734	7.500 (190.5)	0.560 (14.2)	.050 (1.3)	0.400 (10.2)	19	0.550	0.310	0.213	0.130
8545	8.000 (203.2)	0.500 (12.7)	.050 (1.3)	0.200 (5.1)	40	0.591	0.353	0.095	0.053
8709	8.327 (211.5)	0.400 (10.2)	.050 (1.3)	0.215 (5.5)	37	0.507	0.310	0.081	0.048
8715	8.780 (223.0)	0.600 (15.2)	.050 (1.3)	0.270 (6.9)	28	0.384	0.231	0.106	0.063
8707	10.00 (254.0)	0.550 (14.0)	.050 (1.3)	0.238 (6.0)	42	0.361	0.220	0.071	0.042
8121	10.78 (273.8)	0.560 (14.2)	.050 (1.3)	0.238 (6.0)	45	0.348	0.209	0.065	0.040
8733	12.60 (320.0)	0.600 (15.2)	.050 (1.3)	0.207 (5.3)	60	0.383	0.235	0.075	0.030
8714	14.00 (355.6)	0.525 (13.3)	.050 (1.3)	0.250 (6.4)	56	0.275	0.168	0.053	0.032
8735	15.00 (381.0)	0.625 (15.9)	.050 (1.3)	0.250 (6.4)	60	0.264	0.161	0.049	0.030

**NOTES:**

1. Natural and forced convection thermal resistances based on 6.000 in. length for profiles less than 8.000" wide.
2. Natural and forced convection thermal resistances based on 12.000 in. length for profiles 8.000" wide and greater
3. Forced convection thermal resistance based on 500 LFM, shrouded, horizontal. distributed heat load.
4. Forced convection bonded fin assemblies use standard "muffin" fans.
5. Dimensions shown are as extruded. To improve flatness across the width, bases can be machined. Machined base thickness will be reduced.

**Order Guide - Example**

Example Part Number - BE8546-1200-U4W

- BE8546 = Bonded fin base extrusion profile identifier
- Length (inches; 12.00 shown, two decimal point assumed)
- Finish (G = Gold Chromate, U = Unfinished)
- Fin Height (4 inches shown)
- Mounting Options (L = Mounting Legs, W = No Mounting Legs)

**Part Numbering Order Guide\***

BEXXXX - XX - X X X

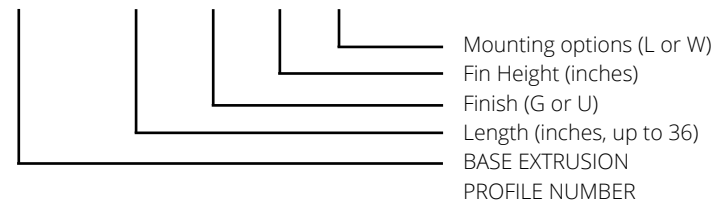

## maxiTHERM-HD<sup>3™</sup> BONDED FIN FORCED CONVECTION SERIES #1

**SERIES #1**

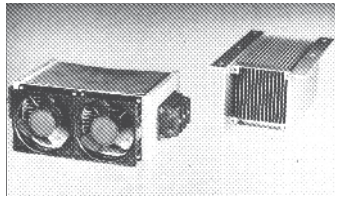

maxiTHERM-HD<sup>3™</sup> Bonded Fin Forced Convection Series #1 heat sinks provide more effective cooling per cubic inch of space compared to extruded heat sinks. Exceptionally low thermal resistance values in forced convection applications are achieved with "Series #1" models, as low as 0.024°C/W for a double unit employing 2 fans. Mounting hole pattern is 4.125 in. sq. for standard 120 mm axial ("box") fans. These heat sinks are ideal for a variety of high power applications, even in the most demanding shock and vibration environments.

SERIES #1 (5.25" TALL ASSEMBLY)						
maxiTHERM-HD <sup>3™</sup> Package Series #1	Standard Muffin Fan (S)	Dimension (in inches)			Perimeter (in inches)	Thermal Resistance °C/W
		"A"	"B"	"C"		
1A	1	7.000 (177.8)	2.500 (63.5)	4.500 (114.3)	742.5 (18859.5)	0.10
1B	1	9.500 (241.3)	3.750 (95.3)	7.000 (114.3)	1515.0 (38481.0)	0.09
1C	1	12.000 (304.8)	5.000 (127.0)	9.500 (114.3)	1567.5 (39814.5)	0.07
1D	1	14.500 (368.3)	6.250 (158.8)	12.000 (114.3)	1980.5 (50304.7)	0.05
1E	2	14.590 (370.6)	6.000 (152.4)	12.000 (114.3)	4536.0 (115214.4)	0.028
1F	2	16.590 (429.0)	7.000 (177.8)	14.000 (114.3)	5292.0 (134416.8)	0.025
1G	2	18.590 (472.2)	8.000 (203.2)	16.000 (114.3)	6048.0 (153619.2)	0.024

1Z NON-STANDARD LENGTH  
ZZ NON-STANDARD CONFIGURATION & LENGTH

Refer to the following page for ordering information.

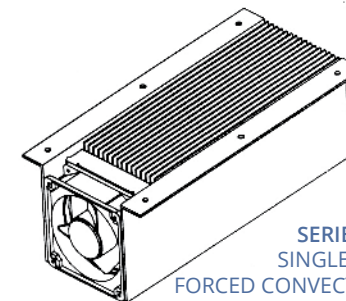

SERIES #1  
SINGLE FAN  
FORCED CONVECTION

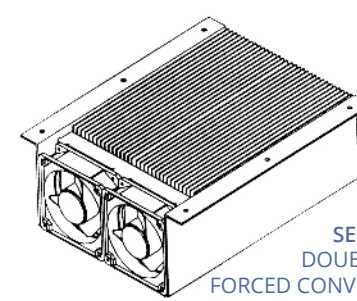

SERIES #1  
DOUBLE FAN  
FORCED CONVECTION

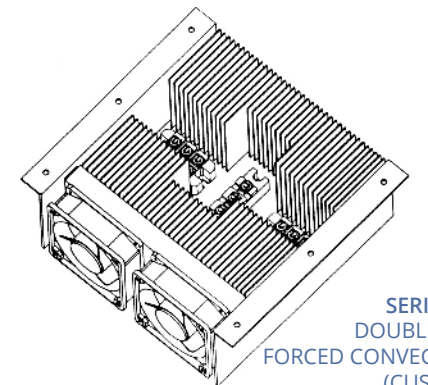

SERIES #1  
DOUBLE FAN  
FORCED CONVECTION  
(CUSTOM)

**MECHANICAL DIMENSIONS**

SERIES #1  
SINGLE FAN FORCED CONVECTION

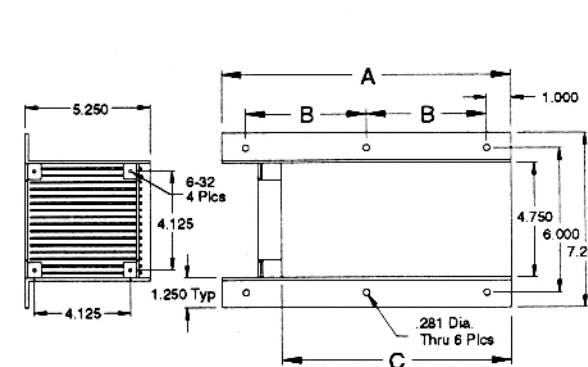

SERIES #1  
DOUBLE FAN FORCED CONVECTION

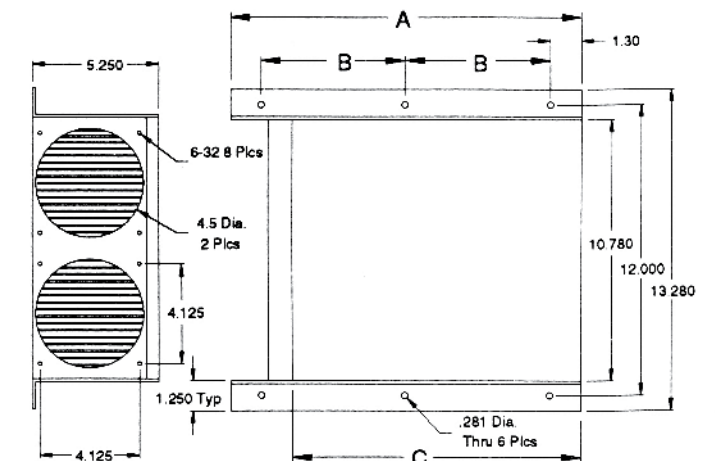

**NOTES:**

1. Standard muffin fans not included, order separately.

# maxiTHERM-HD<sup>3</sup>™ BONDED FIN FORCED CONVECTION SERIES #2

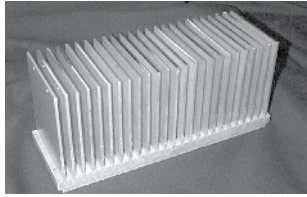

## SERIES #2

maxiTHERM-HD<sup>3</sup>™ Bonded Fin Natural Convection Series #2 heat sinks are designed for a variety of high power applications. These heat sinks are ideal even in the most demanding shock and vibration environments. Standard heat sink lengths range from 7.000 in. (177.8 mm) to 18.590 in. (472.2 mm) and the overall height is 3.130 in. (79.5 mm). Custom lengths, mounting options, and other configurations can be accommodated.

SERIES #2 (3.13" TALL ASSEMBLY)				
maxiTHERM-HD <sup>3</sup> ™ Package Series #2	Dimension (in inches)		Perimeter (in inches)	Thermal Resistance °C/W
	"A"	"B"		
2A	4.500 (114.3)	1.250 (31.8)	427.5 (10858.5)	0.41**
2B	9.500 (177.8)	2.500 (63.5)	665.0 (16891.0)	0.38**
2C	9.500 (241.3)	3.750 (95.3)	902.0 (22910.8)	0.35**
2D	12.000 (304.8)	5.000 (127.0)	1140.0 (28956.0)	0.33**

  

ZZ	NON-STANDARD LENGTH
ZZ	NON-STANDARD CONFIGURATION & LENGTH

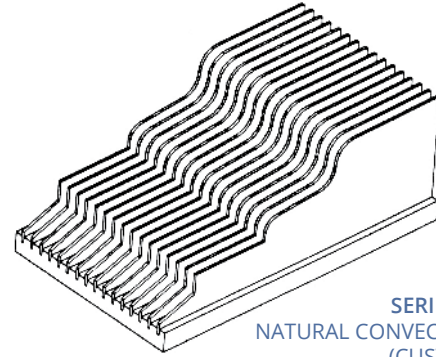

SERIES #2  
NATURAL CONVECTION  
(CUSTOM)

### SERIES #2 NATURAL CONVECTION

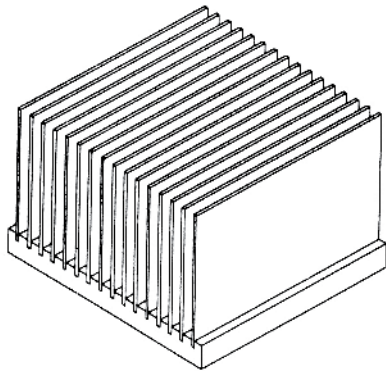

### MECHANICAL DIMENSIONS

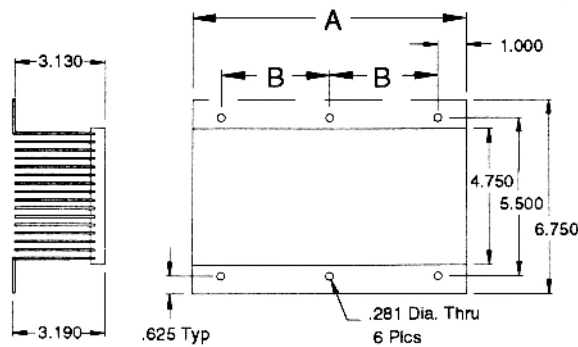

### NOTES:

- All non-standard parts must have a modifier.
- 1Z and 2Z denoting non-standard lengths should only be used for non-standard "A" dimensions. Part # must contain a modifier.
- \*3. When 105 CFM fan (s) used – fan mounting hole pattern for standard axial ("muffin") fan.
- \*\*4. Natural convection based on 50°C heat sink temperature rise above ambient.

### ORDERING INFORMATION

BE8-	-	-	-	-	-	MODIFIER
						NNNN Factory issued number for modification to customer requirements.
						PLATING OPTIONS
						GI Gold Iridite CI Clear Iridite N No Plating (Wash & Etch)
						MOUNTING OPTIONS
						L Mounting Legs F Fan Brackets & Mounting Legs (series #1 only) W No Brackets or Legs
						PACKAGE LENGTH ("A" Dimension)
						SERIES #1 (5.25" tall assembly)
						PN LENGTH
						1A 7.000" 1B 9.500" 1C 12.000" 1D 14.500" 1E 14.590" 1F 16.590" 1G 18.590" 1Z non-standard lengths (Note 2) ZZ non-standard configuration & length
						PACKAGE LENGTH ("A" Dimension)
						SERIES #2 (3.13" tall assembly)
						PN LENGTH
						2A 4.500" 2B 7.000" 2C 9.500" 2D 12.000" 2Z non-standard length (Note 2) ZZ non-standard configuration & length
						BASE EXTRUSION NUMBER
						BE8119 Base profile identifier (SINGLE) BE8121 Base profile identifier (DOUBLE)

# PRECISION CLAMP HEAT SINKS

---

*Precision Compression Mounting Clamp Systems ..... 108-112*

*132/133 Series High-performance Heat Sinks For  
Compression Type Devices ..... 112-113*

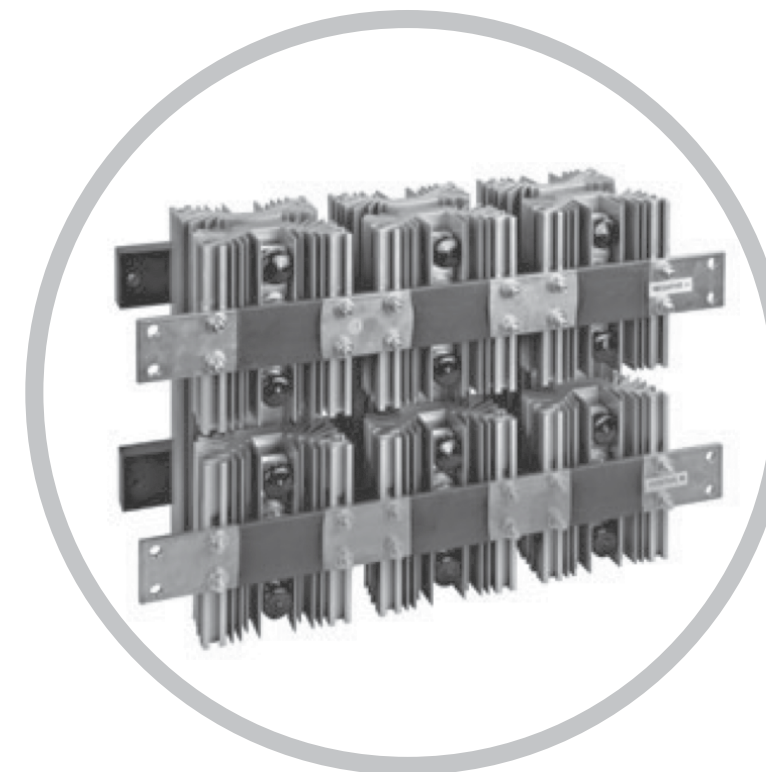

*Wakefield-Vette compression pack heat sink and clamp systems provide customers with the complete system solution for proper installation and heat dissipation for high-power compression pack semiconductors. These high-quality mounting clamp assemblies are the industry standard for mounting, compressing, and clamping press-pack SCR, thyristors, rectifiers, and other high power disc packaged devices. Devices of these styles are most commonly found in power distribution equipment, industrial controls, transportation systems, and power supply and conversion systems.*

*A clamp system consists of a crossbar and a spring assembly. The crossbar is a steel bar with two threaded rods installed in it. The rods are generally knurled and cold rolled into the bar to ensure proper fit. The cross bar assembly is covered in an epoxy coating which acts as an electrical insulator to ensure the devices are properly grounded. The crossbar is installed through the center web of the heat sink and sits in a channel surrounded by fins needed for thermal performance.*

*On the back of the heat sink, a puck style device is installed and then the spring assembly is installed in the threaded rods of the crossbar. By tightening the nuts on the spring assembly, a compression force is applied to the center of the puck. Each spring assembly has a force gauge integrated into it to ensure ease of assembly and consistency of force applied to the many devices used in a system.*

*The cross bar assembly is available in various lengths to meet the various needs of the industry. All components for device mounting are available separately for all standard compression requirements from 800 lbs. to 16,000 lbs.*



## PRECISION COMPRESSION MOUNTING CLAMP SYSTEMS

Wakefield-Vette compression pack heat sinks and clamp systems provide electrical and industrial equipment manufacturers with complete system solutions for proper installation and heat dissipation for high-power compression pack semiconductor. All components for device mounting and cooling are available separately for all standard compression requirements from 800 lbs (362.9 kg) to 16,000 lbs (7,257.5 kg) force in both natural and forced convection applications.

Clamp Assembly Series	Maximum Clamping Force Force Range	Maximum Diameter (Ref) Power Disc Device	Crossbar Stud Centerline to Centerline Dimension
130 Series	800 lbs (362.9 kg) - 2,000 lbs (907.2 kg)	2.25 in. (57.2 mm)	2.750 in. (69.9 mm) Ref
139 Series	3,000 lbs (1,360.8 kg) and 5,000 lbs (2,268.0 kg)	3.50 in. (88.9 mm)	4.000 in. (101.6 mm) Ref
143 Series	1,000 lbs (453.6 kg) - 6,000 lbs (2,721.6 kg)	3.50 in. (88.9 mm)	4.000 in. (101.6 mm) Ref
144 Series	1,000 lbs (453.6 kg) - 6,000 lbs (2,721.6 kg)	4.00 in. (101.6 mm)	4.625 in. (117.5 mm) Ref
145 Series	2,000 lbs (907.2 kg) - 10,000 lbs (4,535.9 kg)	4.50 in. (114.3 mm)	5.500 in. (139.7 mm) Ref
146 Series	8,000 lbs (3,628.8 kg) - 16,000 lbs (7,257.5 kg)	5.25 in. (133.4 mm)	6.000 in. (152.4 mm) Ref
131/132/133 Series	High-Performance Press Pack Heat Sinks		

These high-quality mounting clamp assemblies are the worldwide standard for mounting, compression, and clamping press-pack SCR, thyristor, and other high power disc packaged devices utilized in power distribution equipment, industrial controls, transportation systems, and power supply and conversion systems.

Clamp assemblies will accommodate devices with overall case diameters to 5.25 in. (133.4 mm) maximum. Vertical device mounting space available for assemblies is determined by selecting an appropriate series crossbar by length which, when a series spring assembly is selected (based on maximum clamping force required), will provide the necessary vertical clearance space. For the 130 and 139 Series, this determination is made by subtracting the chosen spring assembly "Z" dimension (refer to dimensional tables) from the crossbar assembly "X" dimension minimum and maximum values, to calculate the available device mounting space clearance for the particular assembly combination. Spring assembly "Z" dimension is the dimension measured from the spring assembly device mounting surface to the spring assembly top surface. Some series have fixed dimensions for alpha characters. All spring assemblies are designed with a force indicator gauge.

Max SCR DIA	Clamp Series	Force Range	Extrusion Profile	
101.6 mm	ALL	800 - 16000 LBS	XX7151	
84 mm	ALL	800 - 16000 LBS	XX6351	
63 mm	ALL	800 - 16000 LBS	XX5735	
	144	800 - 6000 LBS	XX5360	
	143	800 - 6000 LBS	XX10239	
	144	800 - 6000 LBS	O16235	
	144	800 - 6000 LBS	O14442	
	143	800 - 6000 LBS	XX3529	
	143	800 - 6000 LBS	XX5730	
	143	800 - 6000 LBS	O14191	
	143	800 - 6000 LBS	XX3849	
	50 mm	143	800 - 6000 LBS	XX5733
143		800 - 6000 LBS	XX3559-2	
143		800 - 6000 LBS	XX5736	
143		800 - 6000 LBS	XX3561-2	
143		800 - 6000 LBS	XX5732	
143		800 - 6000 LBS	XX5731	
143		800 - 6000 LBS	XX3560-2	
143		800 - 6000 LBS	O13450	
143		800 - 6000 LBS	XX4554	
143		800 - 6000 LBS	XX5331	
143		800 - 6000 LBS	O03537	
143		800 - 6000 LBS	XX5306	
40 mm		143	800 - 6000 LBS	O14779

## COMPRESSION MOUNTING CLAMP ASSEMBLIES FOR SEMICONDUCTORS TO 2.25 IN. (57.2 MM) DIAMETER

### 130 SERIES

130 SERIES SPRING ASSEMBLY				
Model No.	No. of Leaves	"Z" Dim. in. (mm)	Max Force lb. (kg)	Weight lbs. (gms)
130-1	2	0.90 (22.9)	2,000 (907.2)	0.331 (150.14)
130-2	2	0.50 (12.7)	800 (362.8)	0.19 (86.18)
130-3	3	0.61 (15.5)	1,200 (544.3)	0.219 (99.34)
130-4	4	0.72 (18.3)	1,600 (727.8)	0.333 (151.05)
130-5	5	0.83 (21.1)	2,000 (907.2)	0.408 (185.07)

#### NOTES:

- Spring assemblies are stainless steel leaves with a force indicator gauge, except the lowest cost Type 130-1 spring assembly manufactured from automotive grade stainless steel.

**Order Guide:** Order Crossbar and Spring Assembly separately by type number from table.  
**Dimensions:** in. (mm) lb. (kg)

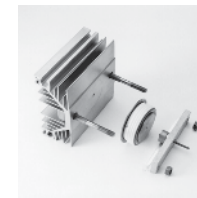

### 139 SERIES

## COMPRESSION MOUNTING CLAMP ASSEMBLIES FOR SEMICONDUCTORS TO 3.50 IN. (88.9 MM) DIAMETER

139 SERIES CROSSBAR 3,000 lb - 5,000 lb, (1,360.8 kg - 2,268.0 kg), Crossbar Device Mounting, Surface to Spring Assembly, Top Surface Dimension							
139-3 SERIES CROSSBAR - 3,000 LB (1,360.8)				139-5 SERIES CROSSBAR - 5,000 LB (2,268.0)			
Model No.	"X" Dimension		Weight lbs. (grams)	Model No.	"X" Dimension		Weight lbs. (grams)
	Min in. (mm)	Max in. (mm)			Min in. (mm)	Max in. (mm)	
139-3A	1.52 (38.6)	1.89 (48.0)	0.689 (312.52)	139-5A	1.52 (38.6)	1.89 (48.0)	0.94 (426.38)
139-3B	1.83 (46.5)	2.21 (56.1)	0.7 (317.51)	139-5B	1.83 (46.5)	2.21 (56.1)	0.96 (435.45)
139-3C	2.14 (54.4)	2.52 (64.0)	0.706 (320.24)	139-5C	2.14 (54.4)	2.52 (64.0)	0.98 (444.52)
139-3D	2.45 (62.2)	2.83 (71.9)	0.721 (327.04)	139-5D	2.45 (62.2)	2.83 (71.9)	1.01 (458.13)
139-3E	2.77 (70.4)	3.14 (79.8)	0.732 (332.03)	139-5E	2.77 (70.4)	3.14 (79.8)	1.02 (462.66)
139-3F	3.08 (78.2)	3.45 (87.6)	0.741 (336.11)	139-5F	3.08 (78.2)	3.45 (87.6)	1.033 (468.56)
139-3G	3.39 (86.1)	3.77 (95.8)	0.762 (345.64)	139-5G	3.39 (86.1)	3.77 (95.8)	1.053 (477.63)
139-3H	3.70 (94.0)	4.08 (103.6)	0.773 (350.63)	139-5H	3.70 (94.0)	4.08 (103.6)	1.074 (487.64)
130-3J	4.01 (101.9)	4.39 (111.5)	0.784 (355.62)	139-5J	4.33 (101.9)	4.39 (111.5)	1.064 (482.62)
139-3K	4.33 (110.0)	4.70 (119.4)	0.79 (358.34)	139-5K	4.33 (110.0)	4.70 (119.4)	1.075 (487.61)
139-3L	4.64 (117.9)	5.01 (127.3)	0.793 (359.70)	139-5L	4.64 (117.9)	5.01 (127.3)	1.088 (493.51)
139-3M	4.95 (125.7)	5.33 (135.4)	0.796 (361.06)	139-5M	4.95 (125.7)	5.33 (135.4)	1.102 (499.86)
139-3N	5.26 (133.6)	5.64 (143.3)	0.832 (377.39)	139-5N	5.26 (133.6)	5.64 (143.3)	1.11 (503.49)
139-3P	5.57 (141.5)	5.95 (151.1)	0.838 (380.11)	139-5P	5.57 (141.5)	5.95 (151.1)	1.171 (531.16)

CROSSBAR HEIGHT AND WIDTH		
Series Number	Height "A" Reference in. (mm)	Width "B" Reference in. (mm)
139-3	0.72 (18.3)	0.95 (24.1)
139-5	1.02 (25.9)	0.83 (21.1)

139 SERIES SPRING ASSEMBLY			
Model Number	Number of Leaves	"Z" Dimension in. (mm)	Maximum Force lb. (kg)
139-1	1	0.87(22.1)	3,000 (1,360.8)
139-2	2	1.25(31.8)	5,000 (2,268.0)



### 130 SERIES

## COMPRESSION MOUNTING CLAMP ASSEMBLIES FOR SEMICONDUCTORS TO 2.25 IN. (57.2 MM) DIAMETER

130 SERIES CROSSBAR 800 lb - 2,000 lb (362.8 kg - 907.2 kg)			
Crossbar Device Mounting, Surface to Spring Assembly Top Surface Dimension			
Model No.	"X" Dimension		Weight lbs. (grams)
	Min. in. (mm)	Max. in. (mm)	
130-A	1.74 (44.2)	2.12 (53.8)	0.4 (181.44)
130-B	2.05 (52.1)	2.43 (61.7)	0.418 (189.60)
130-C	2.36 (59.9)	2.74 (69.6)	0.427 (193.68)
130-D	2.67 (67.8)	3.05 (77.5)	0.437 (198.22)
130-E	2.98 (75.7)	3.36 (85.3)	0.447 (202.76)
130-F	3.29 (83.6)	3.67 (93.2)	0.461 (209.11)
130-G	3.60 (91.4)	3.98 (101.1)	0.476 (215.91)
130-H	3.91 (99.3)	4.29 (109.0)	0.486 (220.45)
130-J	4.22 (107.2)	4.60 (116.8)	0.497 (225.44)
130-K	4.53 (115.1)	4.91 (124.7)	0.51 (231.33)
130-L	4.34 (122.9)	5.22 (132.6)	0.52 (235.87)
130-M	5.15 (130.8)	5.53 (140.5)	0.534 (242.22)
130-N	5.46 (138.7)	5.84 (147.3)	0.544 (246.75)
130-P	5.77 (146.6)	6.15 (156.2)	0.559 (253.56)

#### MECHANICAL DIMENSIONS

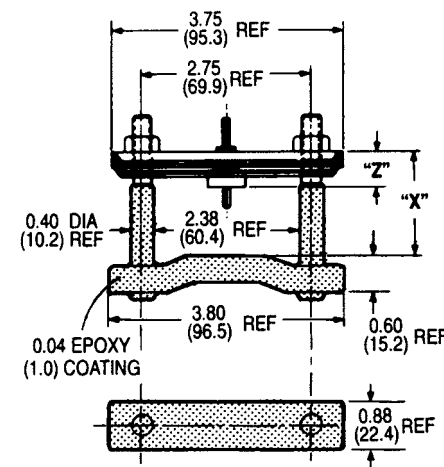

Dimensions: in. (mm)

#### MECHANICAL DIMENSIONS

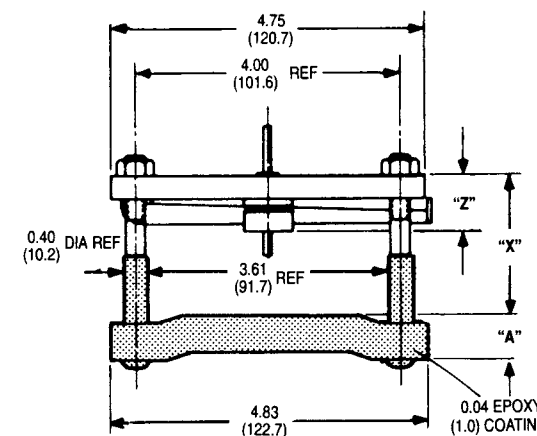

Dimensions: in. (mm)

**Order Guide:** Order Crossbar and Spring Assembly separately by type number from table.  
**Dimensions:** in. (mm) lb. (kg)

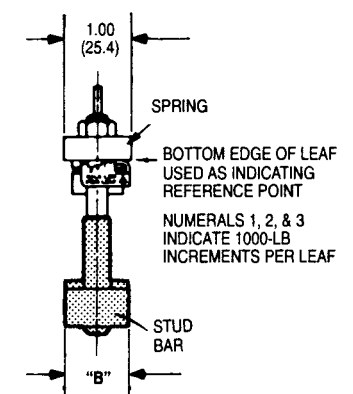

# PRECISION COMPRESSION MOUNTING CLAMP SYSTEMS

## 143 SERIES

COMPRESSION MOUNTING CLAMP ASSEMBLIES FOR SEMICONDUCTORS TO 3.50 IN. (88.9 MM) DIAMETER

143 SERIES CROSSBAR 2,000 lb - 6,000 lb (907.2 kg - 2,721.6 kg)				
Crossbar Device Mounting, Surface to Spring Assembly, Top Surface Dimension				
Model No.	"X" Dimension		Overall Height "H" in. (mm)	Weight lbs. (grams)
	Min in. (mm)	Max in. (mm)		
143-A	1.30 (33.0)	1.80 (45.7)	4.68 (118.9)	1,100 (498.95)
143-B	1.86 (45.7)	2.30 (58.4)	5.18 (131.6)	1,125 (510.29)
143-C	2.30 (58.4)	2.80 (71.1)	5.68 (144.3)	1,150 (521.63)
143-D	2.80 (71.1)	3.30 (83.8)	6.18 (157.0)	1,175 (532.97)
143-E	3.30 (83.8)	3.80 (96.5)	6.68 (169.7)	1,200 (544.31)
143-F	3.80 (96.5)	4.30 (109.2)	7.18 (182.4)	1,225 (555.65)
143-G	4.30 (109.2)	4.80 (121.9)	1.68 (195.1)	1,250 (566.99)
143-H	4.80 (121.9)	5.30 (134.6)	8.18 (207.8)	1,275 (578.33)
143-J	5.30 (134.6)	5.80 (147.3)	8.68 (220.5)	1,300 (589.67)
143-K	5.80 (147.3)	6.30 (160.0)	9.18 (233.2)	1,325 (601.00)
143-L	6.30 (160.0)	6.80 (172.7)	9.68 (245.9)	1,350 (612.35)

143 SERIES SPRING ASSEMBLY			
Model Number	Number of Leaves	Max. Clamping Force lb. (kg)	Weight lb. (grams)
143-2	2	6,000 (2,721.6)	0.813 (368.77)

**Order Guide:** Order Crossbar and Spring Assembly separately by type number from table.  
**Dimensions:** in. (mm) / lb. (kg)

### MECHANICAL DIMENSIONS

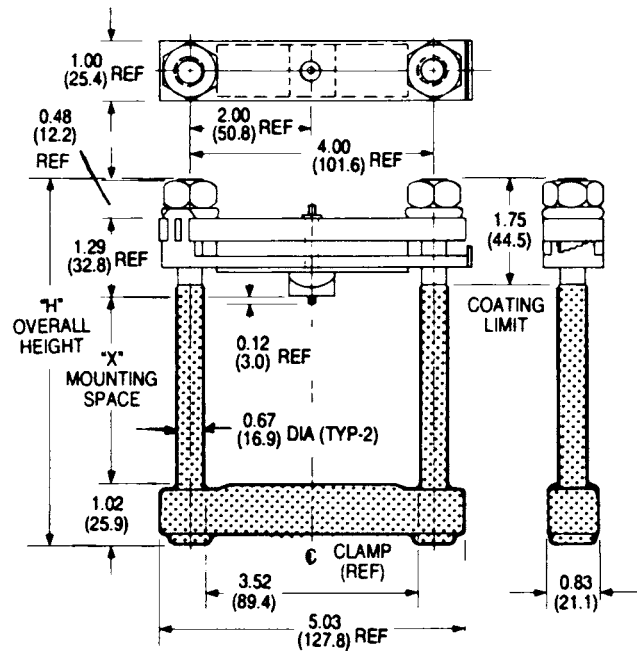

Dimensions: in. (mm)

COMPRESSION MOUNTING CLAMP ASSEMBLIES FOR SEMICONDUCTORS TO 4.00 IN. (101.6 MM) DIAMETER

## 144 SERIES

144 SERIES CROSSBAR 1,000 lb - 6,000 lb (453.6 kg - 2,721.6 kg)			
Crossbar Device Mounting, Surface to Spring Assembly, Top Surface Dimension			
Model No.	"X" Dimension		Weight lbs. (grams)
	Min in. (mm)	Max in. (mm)	
144-A	1.50 (38.1)	2.00 (50.8)	1,231 (558.37)
144-B	2.00 (50.8)	2.50 (63.5)	1,262 (572.43)
144-C	2.50 (63.5)	3.00 (76.2)	1,285 (582.87)
144-D	3.00 (76.2)	3.50 (88.9)	1,310 (594.21)
144-E	3.50 (88.9)	4.00 (101.6)	1,352 (613.26)

144 SERIES SPRING ASSEMBLY		
Model No.	Clamping Force Range lb. (kg)	Weight lbs. (grams)
144-2	1,000 (453.6) - 6,000 (2,721)	1.772 (803.77)

**Order Guide:** Order Crossbar and Spring Assembly separately by type number from table.  
**Dimensions:** in. (mm) / lb. (kg)

### MECHANICAL DIMENSIONS

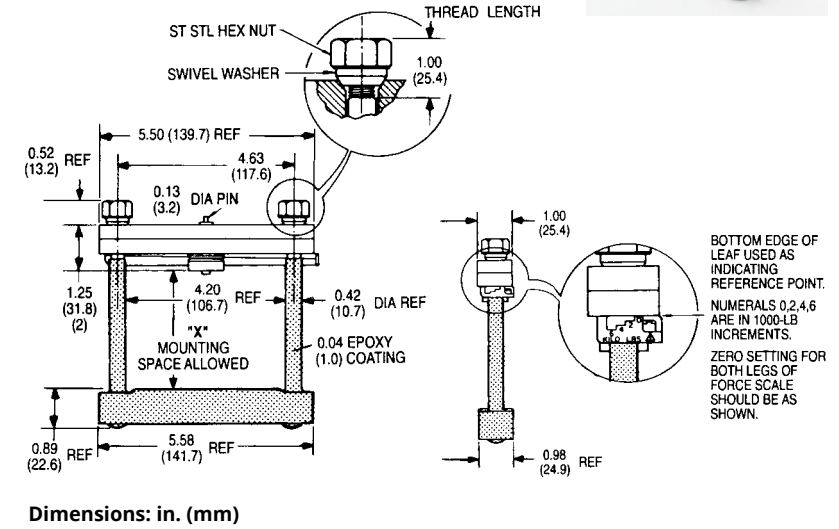

Dimensions: in. (mm)

## 145 SERIES

COMPRESSION MOUNTING CLAMP ASSEMBLIES FOR SEMICONDUCTORS TO 4.50 IN. (114.3 MM) DIAMETER

145 SERIES CROSSBAR 2,000 lb - 10,000 lb (907.2 kg - 4,535.9 kg)				
Crossbar Device Mounting, Surface to Spring Assembly, Top Surface Dimension				
Model No.	"X" Dimension		Overall Height "H" in. (mm)	Weight lbs. (grams)
	Min in. (mm)	Max in. (mm)		
145-A	1.75 (44.5)	2.50 (63.5)	6.00 (152.4)	3,845 (1744.06)
145-B	2.50 (63.5)	3.25 (82.6)	6.75 (171.5)	3,987 (1808.47)
145-C	3.25 (82.6)	4.00 (101.6)	7.50 (190.5)	4,06 (1841.58)
145-D	4.00 (101.6)	4.75 (120.7)	8.25 (209.6)	4,187 (1899.19)
145-E	4.75 (120.7)	5.50 (139.7)	9.00 (228.6)	4,37 (1982.20)
145-F	5.50 (139.7)	6.25 (158.8)	9.75 (247.7)	4,459 (2022.57)

145 SERIES SPRING ASSEMBLY		
Model No.	Clamping Force Range lb. (kg)	Weight lbs. (grams)
145-2	2,000 (907.2) - 10,000 (4,535.9)	2.01 (911.72)

**Order Guide:** Order Crossbar and Spring Assembly separately by type number from table.  
**Dimensions:** in. (mm) / lb. (kg)

### MECHANICAL DIMENSIONS

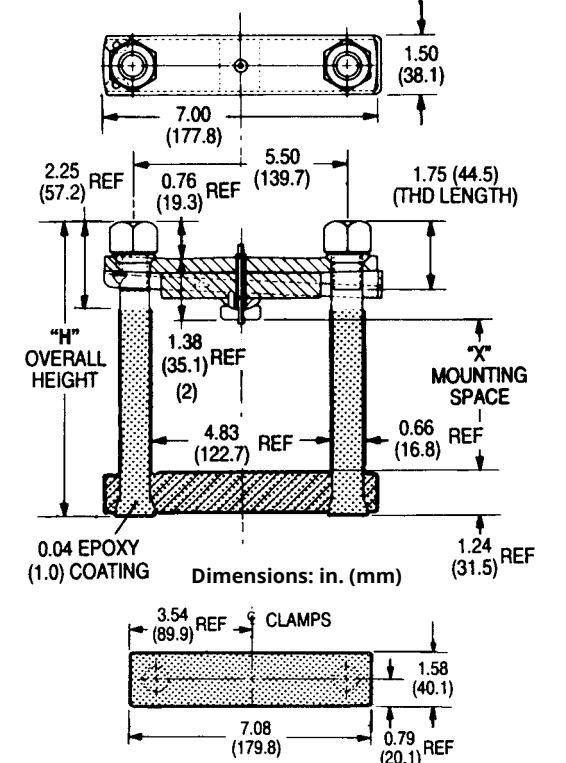

Dimensions: in. (mm)

# PRECISION COMPRESSION MOUNTING CLAMP SYSTEMS

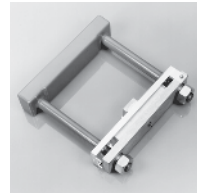

## 146 SERIES

COMPRESSION MOUNTING CLAMP ASSEMBLIES FOR SEMICONDUCTORS TO 5.25 IN. (133.5 MM) DIAMETER

**146 SERIES CROSSBAR**  
8,000 lb-16,000 lb (3,628.7 kg - 7,257.4 kg)

Crossbar Device Mounting, Surface to Spring Assembly, Top Surface Dimension

Model No.	"X" Dimension		Overall Height "H" in. (mm)	Weight lbs. (grams)
	Min in. (mm)	Max in. (mm)		
146-A	1.54 (39.1)	2.29 (58.2)	5.92 (150.4)	3.813 (1729.55)
146-B	2.29 (58.2)	3.04 (77.2)	6.67 (169.4)	3.938 (1786.25)
146-C	3.04 (77.2)	3.79 (96.3)	7.42 (188.5)	4.063 (1842.95)
146-D	3.79 (96.3)	4.54 (115.3)	8.17 (207.5)	4.188 (1899.64)
146-E	4.54 (115.3)	5.29 (134.4)	8.92 (226.6)	4.313 (1956.34)
146-F	5.29 (134.4)	6.04 (153.4)	9.67 (245.6)	4.438 (2013.04)
146-G	6.04 (153.4)	6.79 (172.5)	10.42 (264.7)	4.563 (2069.74)

**146 SERIES SPRING ASSEMBLY**

Model Number	Number of Leaves	Clamping Force Range lb. (kg)	Maximum Force lb. (grams)
146-2	2	8,000 (3,628.7) - 16,000 (7,257.5)	2,688 (1,219.26)

**Order Guide:**  
Order Crossbar and Spring Assembly separately by type number from table.

**Dimensions:**  
in. (mm)  
lb. (kg)

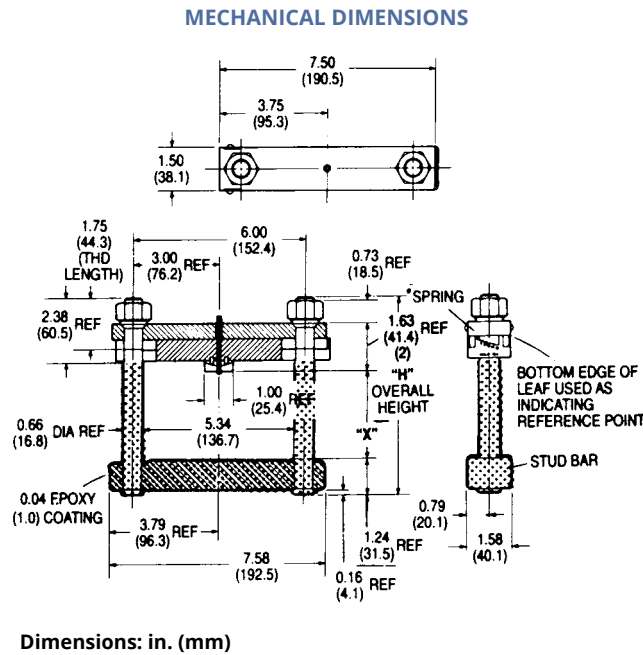

## 132 & 133 SERIES

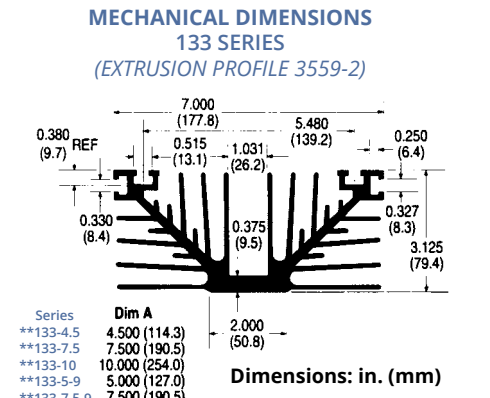
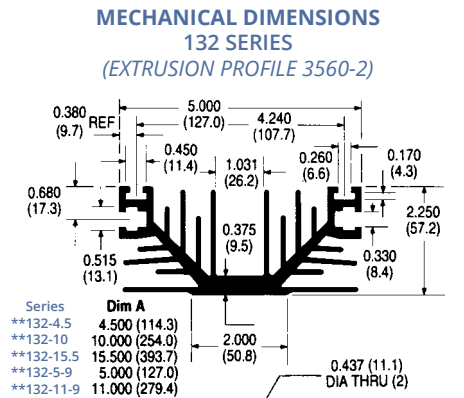
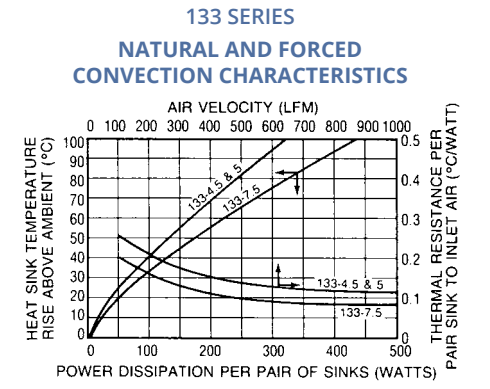
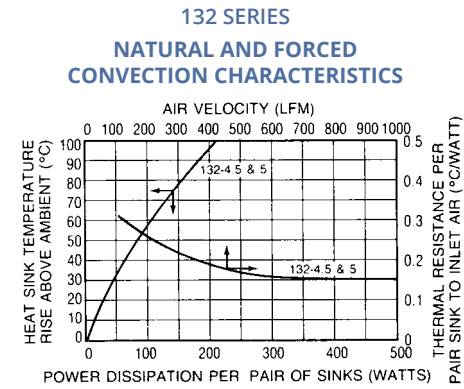

# 132/133 SERIES HIGH-PERFORMANCE HEAT SINKS FOR COMPRESSION TYPE DEVICES

## 132 & 133 SERIES

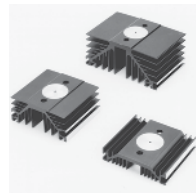

Standard P/N		Width in. (mm)	Nominal Dimensions: <sup>(1)</sup> Length "A" in. (mm)	Height in. (mm)	Clamp System Series <sup>(5)</sup>	Thermal Performance at Typical Load <sup>(2)</sup>	
Black Anodize <sup>(4,5)</sup>	Gold Iridite					Natural Convection (°C/W) <sup>(3)</sup>	Convection (°C/W) @ 500 LFM
132-4.5B	132-4.5G	5.000 (127.0)	4.500 (114.3)	2.250 (57.2)	130	0.61	0.170
132-10B	132-10G	5.000 (127.0)	10.000 (254.0)	2.250 (57.2)	130	0.38	0.130
132-15.5B	132-15.5G	5.000 (127.0)	15.500 (393.7)	2.250 (57.2)	130	0.28	0.100
132-5-B9	132-5-G9	5.000 (127.0)	5.000 (127.0)	2.250 (57.2)	139	0.61	0.170
132-11-B9	132-11-G9	5.000 (127.0)	11.000 (299.4)	2.250 (57.2)	139	0.37	0.120
133-4.5B	133-4.5G	7.000 (139.2)	4.500 (114.3)	3.125 (79.4)	130	0.37	0.110
133-7.5B	133-7.5G	7.000 (139.2)	7.500 (190.5)	3.125 (79.4)	130	0.28	0.085
133-10B	133-10G	7.000 (139.2)	10.000 (254.0)	3.125 (79.4)	130	0.26	0.082
133-5-B9	133-5-G9	7.000 (139.2)	5.000 (127.0)	3.125 (79.4)	139	0.37	0.110
133-7.5-B9	133-7.5-G9	7.000 (139.2)	7.500 (190.5)	3.125 (79.4)	139	0.28	0.085
133-11-B9	133-11-G9	7.000 (139.2)	11.000 (279.4)	3.125 (79.4)	139	0.24	0.076

**Material:** Aluminum, Black Anodized  
**Finish:** B = Black Anodized, G = Gold Iridite

### MULTIPLE ASSEMBLY CONFIGURATION

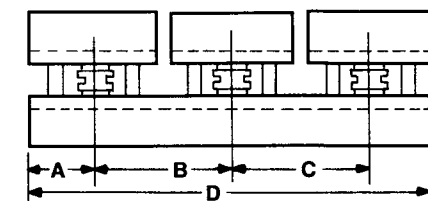

Type	Use with	A	B	C	D
132-4.5	-	-	-	See Fig.132	-
132-10	2 ea 132-4.5	2.25	5.50	-	10.0
132-15.5	3 ea 132-4.5	2.25	5.50	5.50	15.5
133-4.5	-	-	-	See Fig.133	-
133-7.5	-	-	-	See Fig.133	-
133-10	2 ea 133-4.5	2.25	5.50	-	10.0
132-5-9**	-	-	-	See Fig.132	-
132-11-9**	2 ea 132-5-9	2.50	6.00	-	11.00
133-5-9**	-	-	-	See Fig. 133	-
133-7.5-9**	-	-	-	See Fig. 133	-
133-11-9**	2 ea 133-5-9	2.50	6.00	-	11.00

\*\* -9 indicates heat sinks drilled for 139 clamp.

### NOTES:

- Nominal dimensions for one heat sink of this type.
- Thermal performance values shown are per pair of heat sinks.
- Natural convection performance at 50°C heat sink rise above ambient.
- Black anodize finish [1.875 in. (47.6 mm) diameter spot face. Device mounting surface area free of finish].
- Predrilled heat sinks accept 130 and 139 Series clamp systems.



# LIQUID COOLING

<i>Liquid Cold Plates For High-Performance Components &amp; Systems</i> .....	116–117
<i>Exposed Tube Liquid Cold Plates</i> .....	118–119
<i>Full Buried Tube Liquid Cold Plates</i> .....	120–122

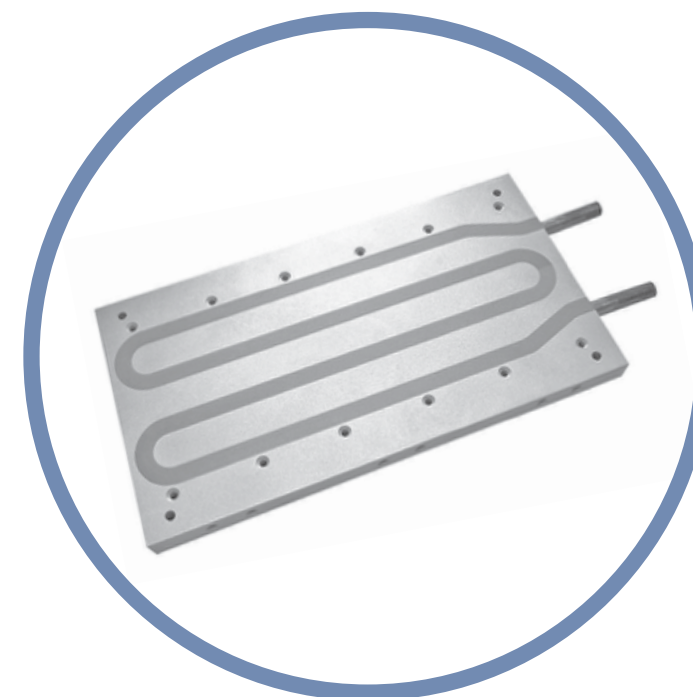

*Liquid cooling is a natural evolution beyond air cooling where either due to thermal requirements or footprint requirements, the desired performance can no longer be economically met by air cooling.*

*There are many ways to accomplish liquid cooling, but the most common method is to have a plate with a flow path that moves liquid under the devices. After the heat is absorbed into the liquid, it is taken out of the plate and into the larger system. While water or water/glycol are the most common fluids used in liquid cooling, gasoline, oil, and refrigerant are other fluids that can be utilized.*

*There are lots of ways to construct a cold plate and the methods can be driven by the level of performance needed, the materials needed or the environmental requirements.*

*One construction method is to use a series of cross drilled holes in a plate. The holes intersect in the plate to determine the flow pattern and unneeded patterns are plugged. This construction method can be cost effective, but the pattern is limited to straight lines.*

*Another method is to embed a tube in a plate by machining a groove in the plate. The tube can either be placed toward the top surface of the plate to provide better cooling to devices mounted on that surface, or it can be embedded further into the plate so that it cools devices mounted on both sides of the plate. This option provides greater flexibility, but the thermal performance is limited because of the surface area of the tube perimeter.*

*To get more performance, extended surface area in contact with the fluid is required and this leads to machined cold plates. The cold plate is constructed of a plate that has been machined to form some flow passages and then a cover is assembled to capture the flow. The extended surface area can be machined in place or installed by use of a piece of folded fin. The cover can be flat or be another machined plate. The method of assembly of the two parts can be done by gasket/screw, glue/screw, brazing, or welding and is dependent on the required performance and the requirements of the environment.*

# LIQUID COLD PLATES FOR HIGH-PERFORMANCE COMPONENTS & SYSTEMS

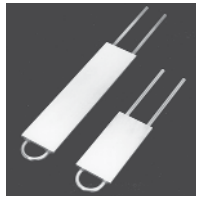

## 180-10 & 180-11 SERIES

LIQUID COLD PLATES FOR RECTIFIERS AND POWER DIODES

General Purpose

Standard P/N	Cold Plate Body Nominal Dimensions				Overall Length in. (mm)	Overall Thermal Resistance (Plate to Inlet Water)	Weight lbs. (grams)
	Length "A" in. (mm)	Width in. (mm)	Thickness in. (mm)	Channel Width in. (mm)			
180-10-6C	6.000 (152.4)	3.000 (76.2)	0.625 (15.9)	1.250 (31.8)	13.406 (340.5)	0.084°C/W @ 1.5 GPM	0.850 (385.56)
180-10-12C	12.000 (304.8)	3.000 (76.2)	0.625 (15.9)	1.250 (31.8)	19.406 (429.9)	0.041°C/W @ 1.5 GPM	1.700 (771.12)
180-10-24C	24.000 (609.6)	3.000 (76.2)	0.625 (15.9)	1.250 (31.8)	31.406 (797.7)	0.020°C/W @ 1.5 GPM	2.900 (1315.4)
180-11-6C	6.000 (152.4)	5.000 (127.2)	0.688 (17.5)	1.813 (46.1)	13.688 (347.7)	0.084°C/W @ 1.5 GPM	1.500 (680.40)
180-11-12C	12.000 (304.8)	5.000 (127.2)	0.688 (17.5)	1.813 (46.1)	19.688 (500.1)	0.041°C/W @ 1.5 GPM	2.867 (1300.47)
180-11-24C	24.000 (609.6)	5.000 (127.2)	0.688 (17.5)	1.813 (46.1)	31.688 (804.9)	0.020°C/W @ 1.5 GPM	5.730 (2599.13)

Material: Aluminum, no finish. Tubing: Copper (stainless steel tubing available on special order).

### LOCAL THERMAL RESISTANCE PER DEVICE PLATE TO INLET WATER (°C/WATT)

℄ to ℄ Device Spacing Inches	Flow - GPM				
	½	1	2	3	4
1.0 (25.4)	0.59	0.52	0.48	0.47	0.46
2.0 (50.8)	0.40	0.36	0.33	0.32	0.31
3.0 (76.2)	0.29	0.26	0.24	0.23	0.22

### PERFORMANCE CHARACTERISTICS

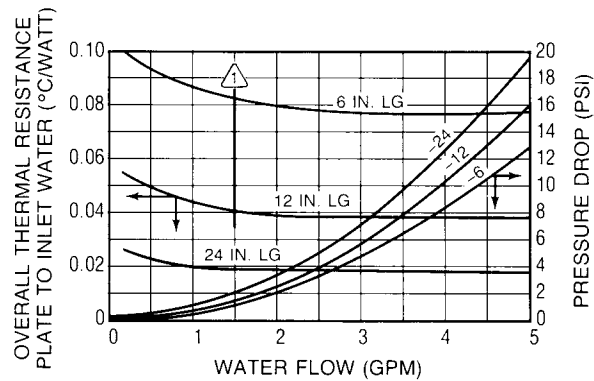

### MECHANICAL DIMENSIONS

#### 180-10 SERIES

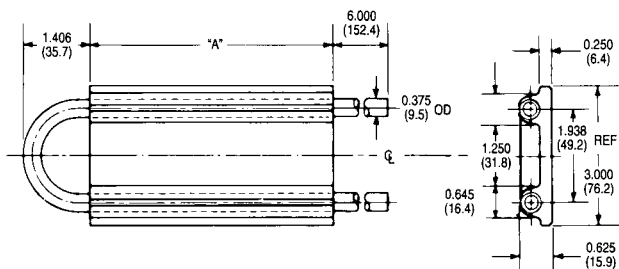

#### 180-11 SERIES

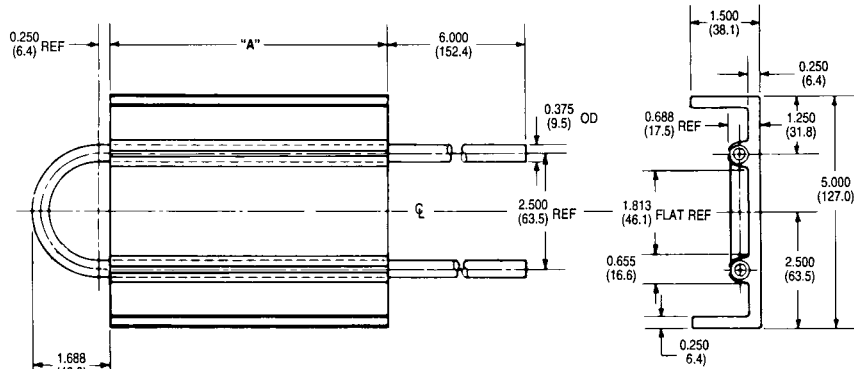

Dimensions: in. (mm)

Standard P/N	Length "A" in. (mm)
180-10-6C	6.000 in. (152.4)
180-10-12C	12.000 in. (304.8)
180-10-24C	24.000 in. (609.6)
180-11-6C	6.000 in. (152.4)
180-11-12C	12.000 in. (304.8)
180-11-24C	24.000 in. (609.6)

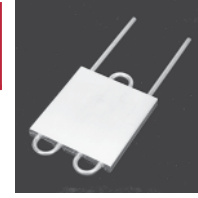

General Purpose

LIQUID COLD PLATES FOR RECTIFIERS, DIODES, AND POWER MODULES

## 180-12 & 180-20 SERIES

Standard P/N	Cold Plate Body Nominal Dimensions			Mounting Surfaces	Overall Length in. (mm)	Overall Thermal Resistance (Plate to Inlet Water)	Weight lbs. (grams)
	Length "A" in. (mm)	Width in. (mm)	Thickness in. (mm)				
180-12-6C	6.000 (152.4)	7.750 (196.9)	0.658 (16.7)	Single	13.406 (340.5)	0.038°C/W @ 1.0 GPM	2.270 (1029.67)
180-12-12C	12.000 (304.8)	7.750 (196.9)	0.658 (16.7)	Single	19.406 (429.9)	0.018°C/W @ 1.0 GPM	4.300 (1950.48)
180-12-24C	24.000 (609.6)	7.750 (196.9)	0.658 (16.7)	Single	31.406 (797.7)	0.009°C/W @ 1.0 GPM	8.600 (3900.96)
180-20-6C	6.000 (152.4)	5.500 (139.7)	0.690 (17.5)	Double	13.125 (333.4)	0.038°C/W @ 1.0 GPM	1.090 (494.42)

### LOCAL THERMAL RESISTANCE PER DEVICE PLATE TO INLET WATER (°C/WATT)

℄ to ℄ Device Spacing Inches	Flow - GPM				
	½	1	2	3	4
1.0 (25.4)	0.76	0.67	0.62	0.59	0.57
2.0 (50.8)	0.58	0.49	0.43	0.40	0.39
3.0 (76.2)	0.42	0.34	0.30	0.28	0.27

### MECHANICAL DIMENSIONS

#### 180-12 SERIES

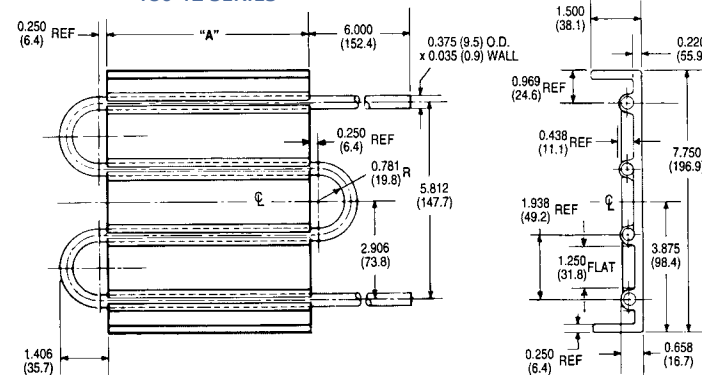

#### 180-20 SERIES

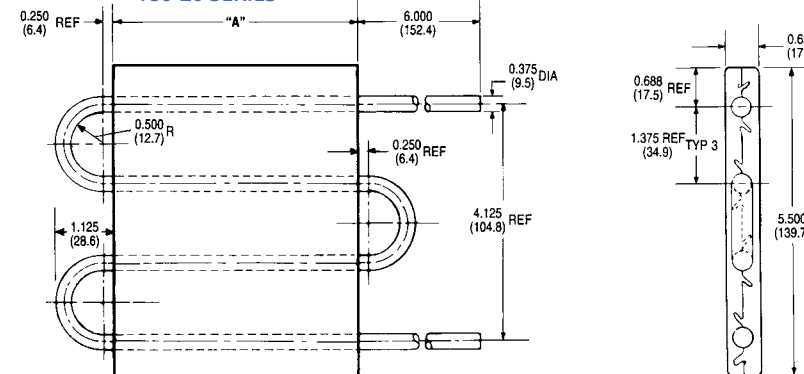

Dimensions: in. (mm)

### PERFORMANCE CHARACTERISTICS

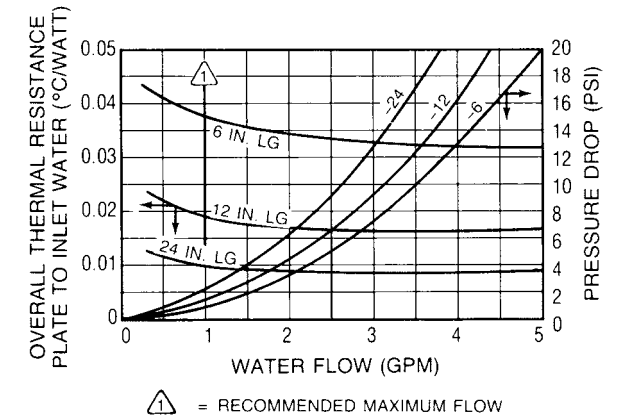

△ = RECOMMENDED MAXIMUM FLOW

Standard P/N	Length "A" in. (mm)
180-12-6C	6.000 in. (152.4)
180-12-12C	12.000 in. (304.8)
180-12-24C	24.000 in. (609.6)
180-20-6C	6.000 in. (152.4)

# EXPOSED TUBE LIQUID COLD PLATES

Wakefield-Vette's exposed tube liquid cold plates ensure minimum thermal resistance between the power device and the cold plate by placing the coolant tube in direct contact with the power device's base. Direct contact reduces the number of thermal interfaces between device and fluid thus increasing performance for the application.

Part Number	Description	"X" Dimension Inches	Passes	Figure
120455	Exposed Tube 2- Pass Cold plate	N/A	2	1
120456	Exposed Tube 4- Pass Cold plate	6.00	4	2
120457	Exposed Tube 4- Pass Cold plate	12.00	4	2
120458	Exposed Tube 6- Pass Cold plate	6.00	6	3
120459	Exposed Tube 6- Pass Cold plate	12.00	6	3
120460	Exposed Tube 6- Pass Cold plate	24.00	6	3

**KEY SPECIFICATIONS**

- Base Plate: Extruded Aluminum.
- Copper Tube Material: .0375" OD x .049" wall.
- Thermal Epoxy fill with high thermal conductivity.

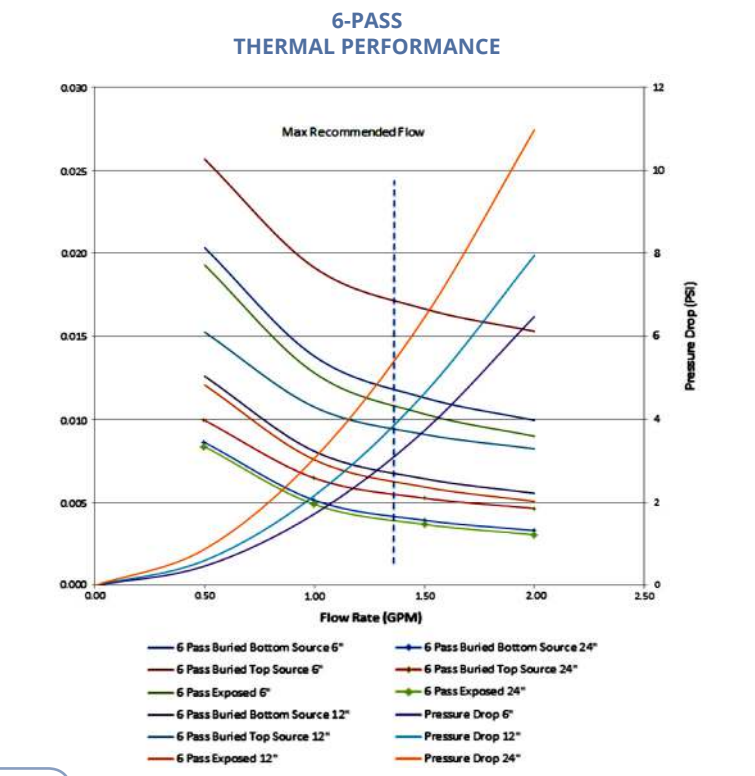
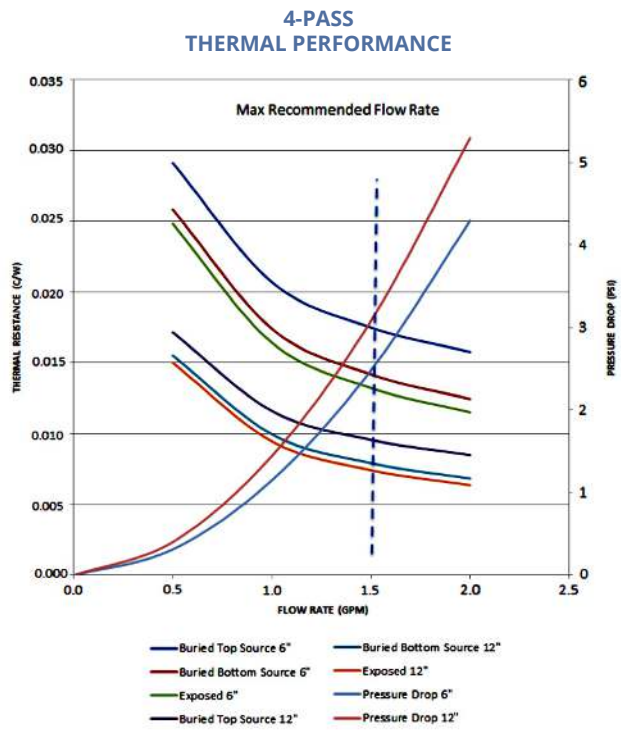
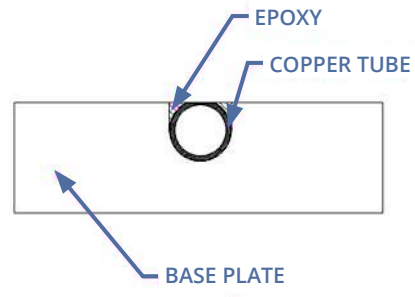
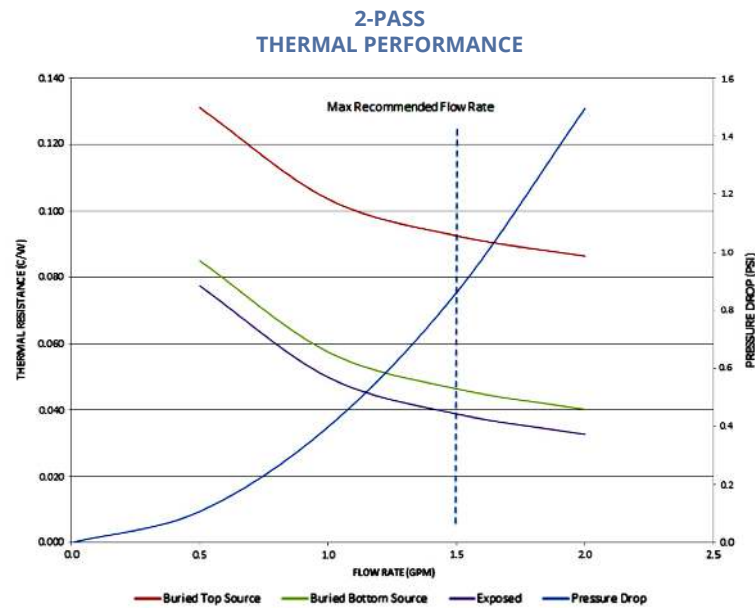

**Custom Exposed Tube Liquid Cold Plates Available**  
 Contact Wakefield-Vette for more information or visit [www.wakefield-vette.com](http://www.wakefield-vette.com)



## PART NUMBER 120455

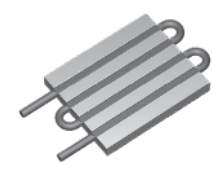
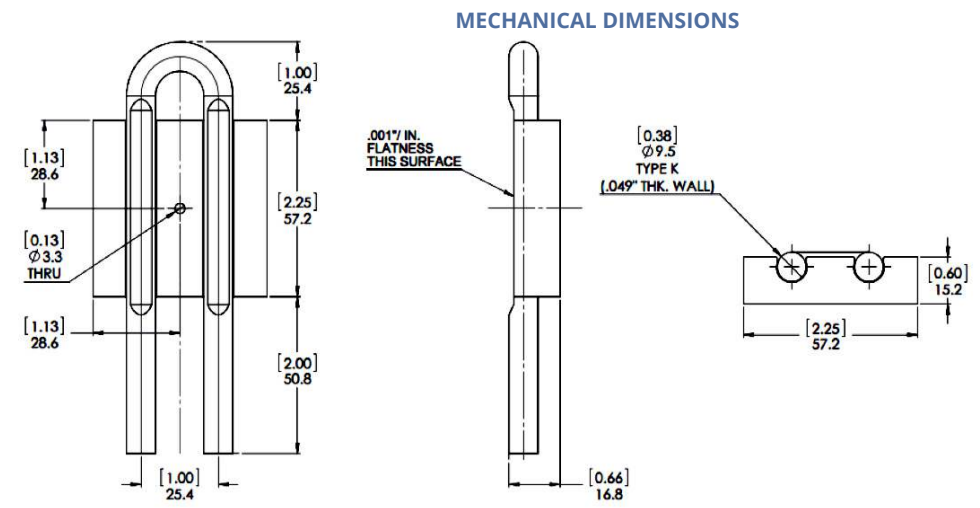
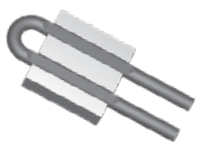

## PART NUMBER 120456 & 120457

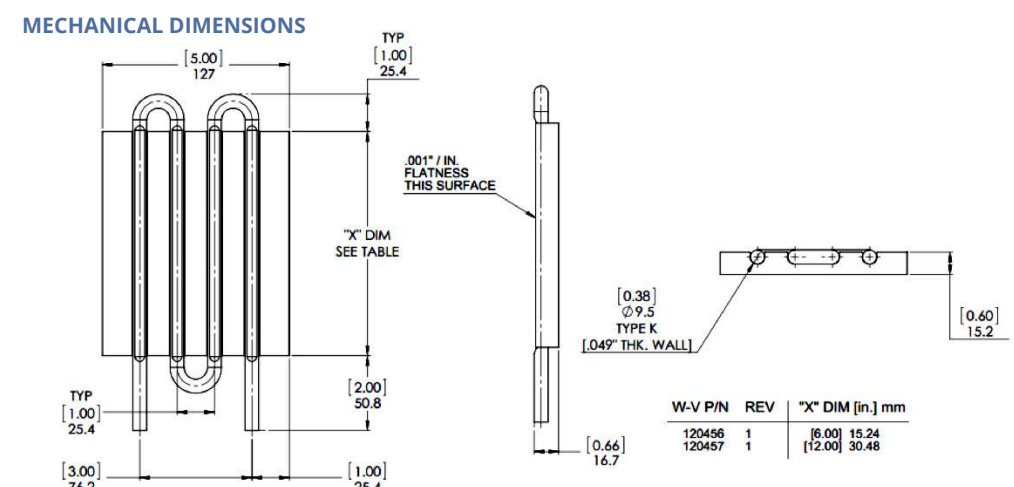

## PART NUMBER 120458, 120459, & 120460

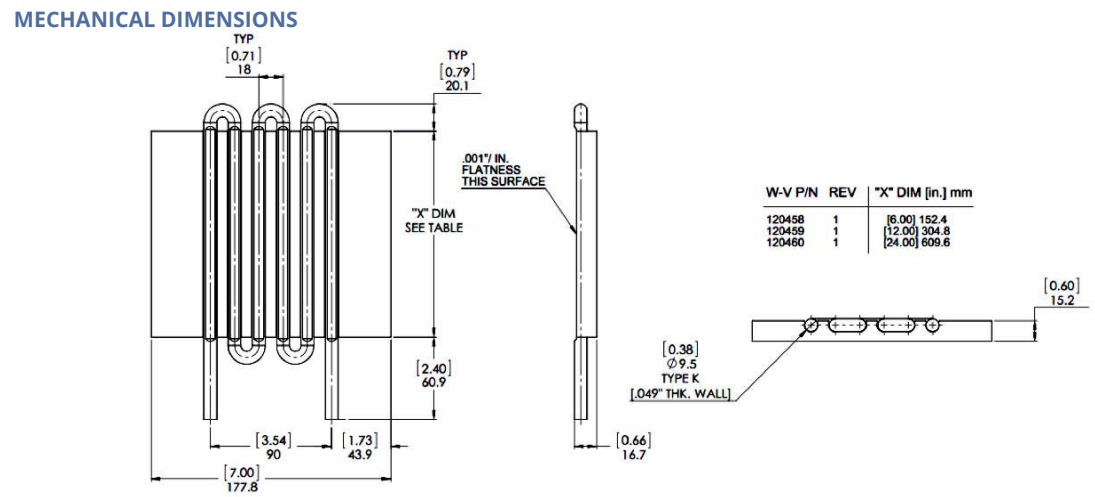
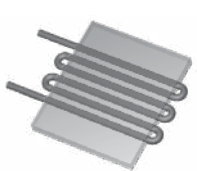



# FULL BURIED TUBE LIQUID COLD PLATES

Wakefield-Vette's fully buried tube liquid cold plates have the ability to cool both sides of the cold plate because of it's positioning within the base plate. Another key feature of the fully buried tube is that it is not exposed to the outside environment. Some engineers prefer the epoxy layer above the tube to protect the tube from leakage.

Part Number	Description	"X" Dimension Inches	Passes	Figure
120959	Fully Buried Tube 2- Pass Cold plate	N/A	2	1
120960	Fully Buried Tube 4- Pass Cold plate	6.00	4	2
120961	Fully Buried Tube 4- Pass Cold plate	12.00	4	2
120962	Fully Buried Tube 6- Pass Cold plate	6.00	6	3
120963	Fully Buried Tube 6- Pass Cold plate	12.00	6	4
120964	Fully Buried Tube 6- Pass Cold plate	24.00	6	5

KEY SPECIFICATIONS	
• Base Plate: Extruded Aluminum.	
• Copper Tube Material: .0375" OD x .049" wall.	
• Thermal Epoxy fill with high thermal conductivity.	

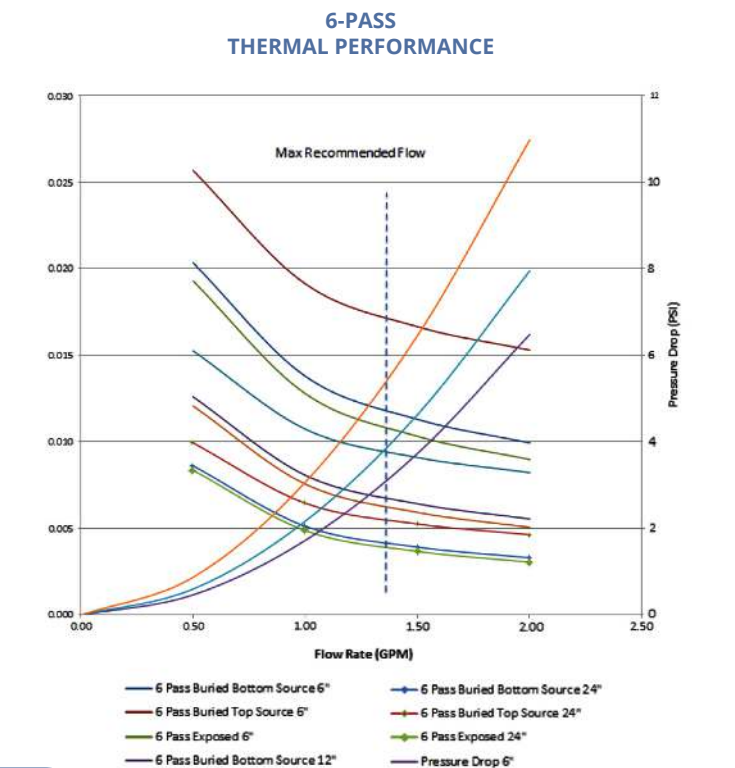
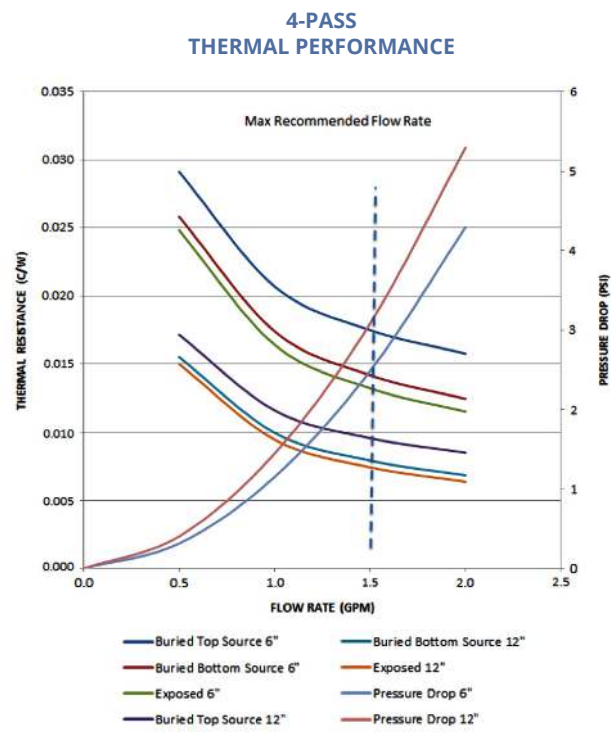
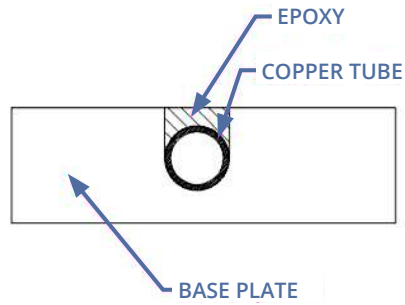
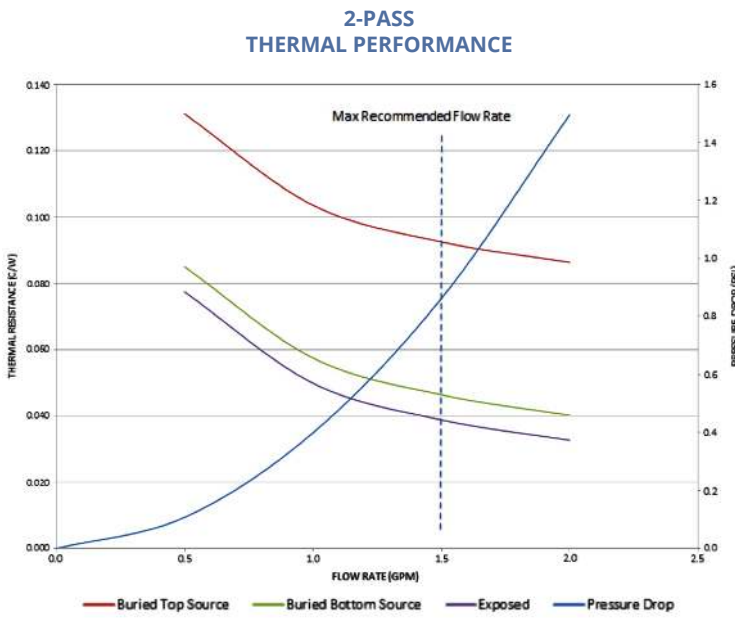

**Custom Full Buried Tube Liquid Cold Plates Available**  
 Contact Wakefield-Vette for more information or visit [www.wakefield-vette.com](http://www.wakefield-vette.com)



## PART NUMBER 120959

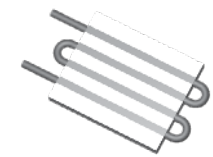
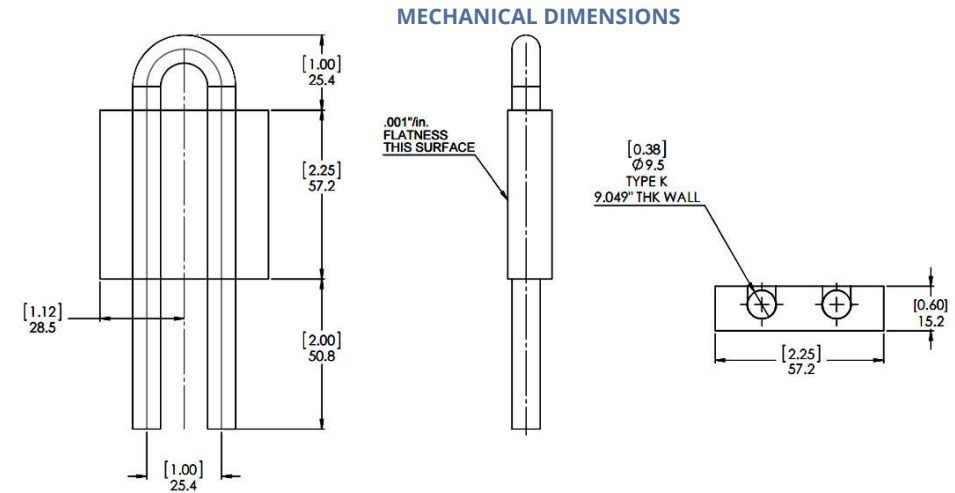
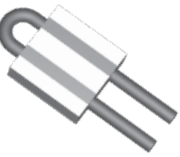

## PART NUMBER 120960 & 120961

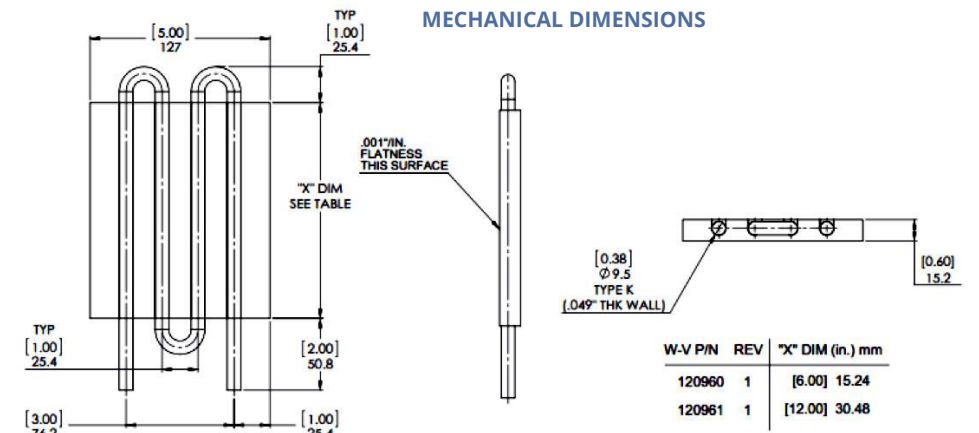

## PART NUMBER 12062

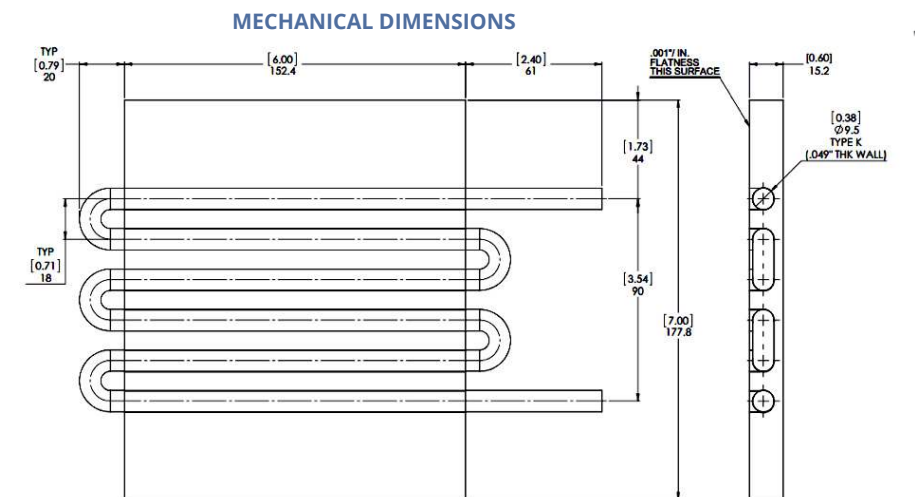
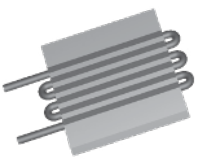

# FULL BURIED TUBE LIQUID COLD PLATES



**PART NUMBER 120963**



MECHANICAL DIMENSIONS

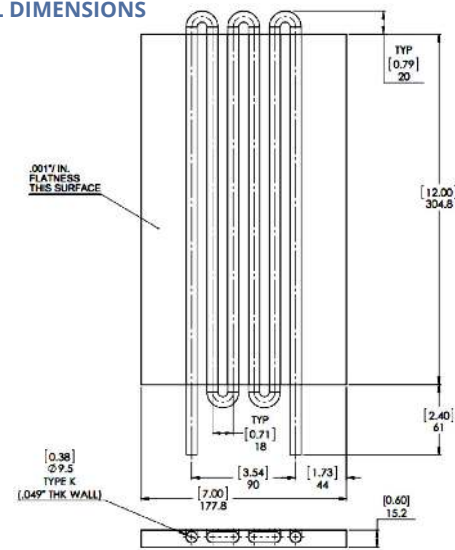

**PART NUMBER 120964**



MECHANICAL DIMENSIONS

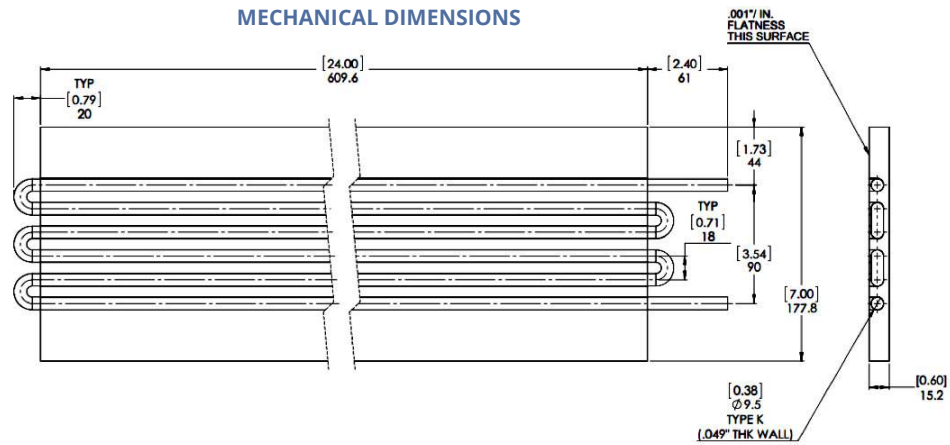

# PHASE CHANGE

Heat Pipe Selection Guide ..... 126-131

Vapor Chamber Design Guide ..... 132-137

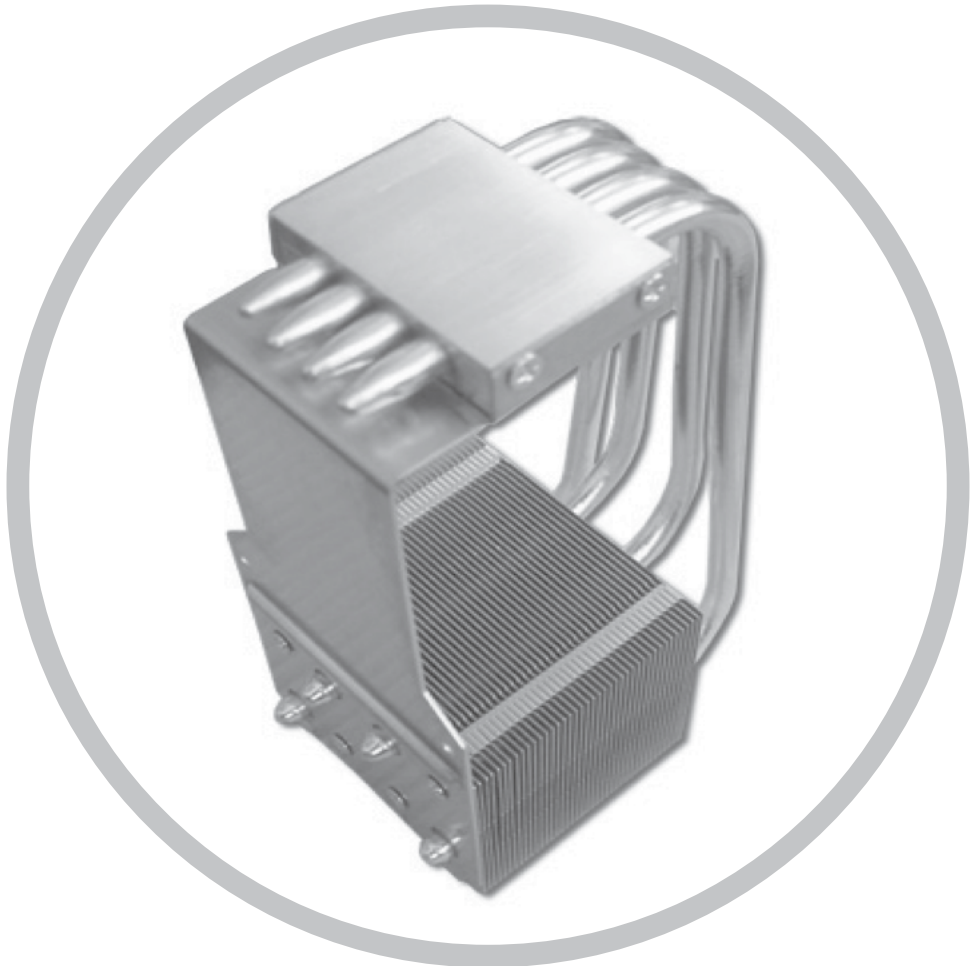

*Fluid Phase Change applications, often referred to as “re-circulating,” use closed loop heat pipes to transfer heat quickly through evaporation and condensation within the heat pipe. Because of their high thermal efficiency, heat pipes are often designed into advanced heat sink technologies when increased thermal density or physical size restrictions exist. This similar process is utilized in vapor chamber technology as well.*



## HEAT PIPE SELECTION GUIDE

### HEAT PIPE INTRODUCTION

Heat pipes are used to transport heat over a distance with very low thermal resistance. This is very helpful when small or distant heat sources need to be dissipated over a larger area or moved to a remote heat exchanger. Heat pipes are a **Fluid Phase Change application**, often referred to as “re-circulating,” because they use a closed loop to transfer heat quickly through evaporation and condensation within the heat pipe.

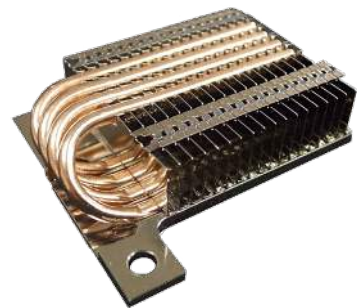

Heat pipes do not actually dissipate the heat to the environment, but serve to move heat efficiently within a thermal system. A heat pipe is a copper tube with an internal wick structure that is sealed on both ends with a small amount of water inside. As heat is applied to the pipe, the water will boil and turn to a gas, which then travels to the colder section of the heat pipe where it condenses back to a liquid. It is the evaporating and condensing of the water that form a pumping action to move the water (and thus the heat) from end to end of the pipe. There are many types of wick structure that can be used within the heat pipe and they are generally classified into grooved, mesh, powder and hybrid.

A **grooved heat pipe** is a copper tube with a series of shallow grooves around the internal perimeter of the heat pipe. While the water is a liquid, it travels in the grooves and while it is a vapor it travels in the open space of the pipe. Grooved pipes can be used in horizontal orientations, but are very limited in performance if used above 15° out of horizontal.

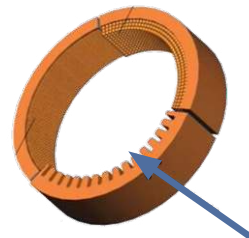

GROOVED HEAT PIPE

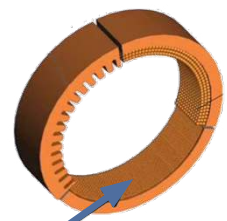

MESH HEAT PIPE

A **mesh heat pipe** is a smooth wall copper tube with a woven copper mesh installed along the interior of the pipe. The mesh is designed to remain in contact with the walls of the pipe in areas where the pipe may be bent or flattened. Mesh pipes can be used in horizontal and orientations up to 30° out of horizontal.

A **powder wick heat pipe** can also be known as a **sintered heat pipe**. During the manufacturing process a mandrel is installed in the center of the pipe and copper powder is poured into the pipe around the mandrel. After the powder is sufficiently packed, the parts are placed into a sintering oven. Once at temperature, the copper powder will stick to the pipe and to itself, forming numerous internal pockets like a sponge. Because of the small pocket sizes, sintered pipes can efficiently move the water and can be used horizontally, vertically and all points in between including upside down.

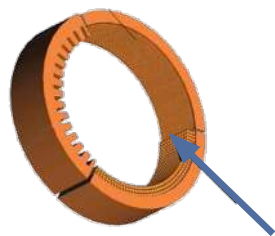

POWDER WICK HEAT PIPE

Wakefield-Vette primarily sells sintered, or powder, style heat pipes due to their higher performance and the best heat pipe for your application.

### WHY USE HEAT PIPES?

Heat pipes have proven to be robust and reliable over many years in these types of applications. The next section will give more technical detail on the performance of heat pipes depending on diameter, length, and angle of use. Many thermal systems benefit from the addition of heat pipes, especially when heat sources are dense and/or remote to the final heat exchanger. Computer applications, such as processors, graphics cards and other chip-sets, have high thermally dissipated power in a small area. Fan heat sink combinations used in these applications can offer high-performance dissipation to the ambient, but much of the battle is to bring the heat to the heat exchanger with as little temperature change as possible. Heat pipes excel at this and can transport large heat loads from small areas with very little temperature difference.

Heat pipes are used in many harsh environments such as:

- Telecommunications
- Aerospace
- Transportation
- Computers and Data Centers

#### KEY FEATURES

- Material: Copper
- Wick Structure: Powder Sintered Copper
- Light Weight
- Versatile with high thermal performance

### HOW HEAT PIPES OPERATE

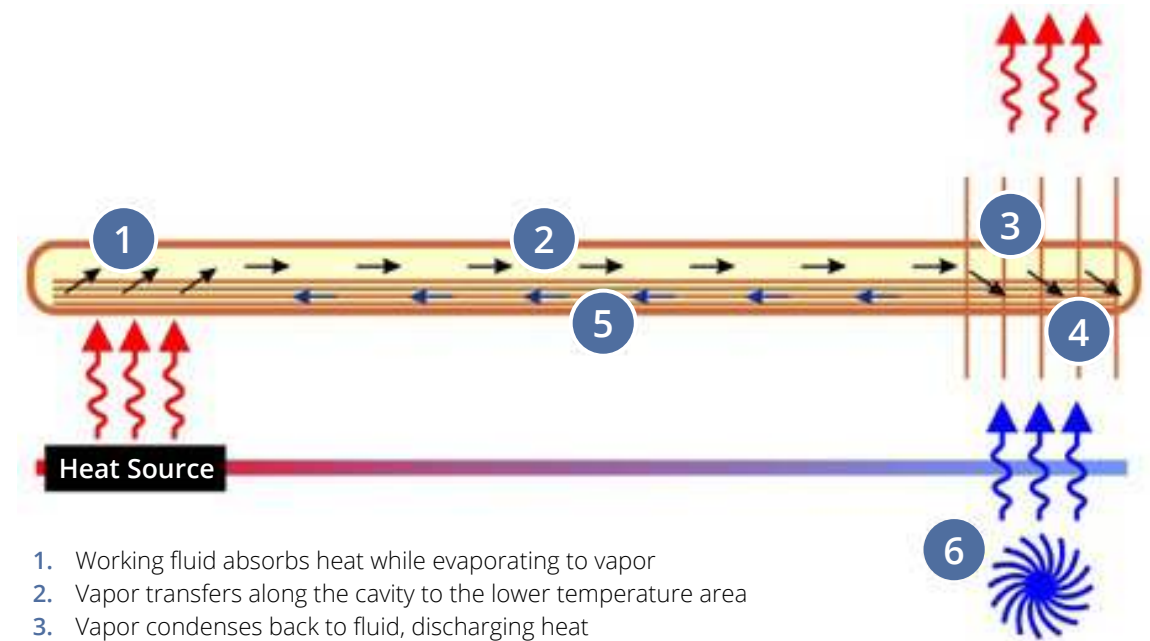

1. Working fluid absorbs heat while evaporating to vapor
2. Vapor transfers along the cavity to the lower temperature area
3. Vapor condenses back to fluid, discharging heat
4. Fluid is absorbed by the sintered/powdered wick structure
5. Fluid returns to high temperature end via capillary force in the wick structure
6. Natural or forced convection air flow dissipates excess heat to ambient

# HEAT PIPE SELECTION GUIDE

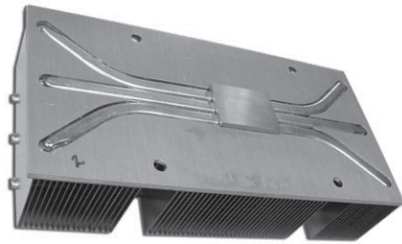

## HEAT PIPE BASICS

When selecting the diameter and length of heat pipe it is important to consider the orientation with respect to gravity and overall heat load for the thermal system. The transport of vapor within the heat pipe is responsible for the thermal conduction from one end to the other. A larger diameter heat pipe can transport more vapor, translating into a larger heat carrying capacity. Also, the orientation of the pipe with respect to gravity plays a role in the thermal capacity of a heat pipe.

### HEAT PIPE BASICS

- Picking the correct pipe
- Transport
- General parameters
- Bending
- Flattening

When selecting the diameter and length of heat pipe it is important to consider the orientation with respect to The thermal capacity is increased when the heat source is lower than the condenser (or ambient heat exchanger) because gravity assists the return of condensed water back to the heat source. The opposite is also true as the thermal capacity is reduced when the condensed water must move by capillary forces back to the heat source against gravity. This effect is exaggerated with longer heat pipes and testing has shown that the gravity effect can nearly the double the thermal capacity in the advantageous direction and cut the capacity in half in the deleterious direction from the heat pipe in the horizontal orientation. In the short heat pipe extreme (3"-4" length), this effect is nearly zero, so please consult with Wakefield-Vette engineers to find the right solution for your application.

MAXIMUM HEAT TRANSFER TABLE (POWDER TYPE)		HEAT PIPE LENGTH = 150MM			
Qmax Type	Out Diameter Φ3mm	Out Diameter Φ4mm	Out Diameter Φ5mm	Out Diameter Φ6mm	Out Diameter Φ8mm
Flatten t=2.0mm	13.2 W	16.6 W	20.5 W		
Flatten t=2.5mm	13.2 W	19.8 W	23.6 W	34.0 W	51.5 W
Flatten t=3.0mm	13.1 W	19.8 W	28.4 W	39.2 W	67.5 W
Round Pipe	13.2 W	19.8 W	30.1 W	48.1 W	74.2 W



MAXIMUM HEAT TRANSFER TABLE (POWDER TYPE)		HEAT PIPE LENGTH = 250MM			
Qmax Type	Out Diameter Φ3mm	Out Diameter Φ4mm	Out Diameter Φ5mm	Out Diameter Φ6mm	Out Diameter Φ8mm
Flatten t=2.0mm	7.2 W	10.1 W	12.2 W		
Flatten t=2.5mm	8.1 W	11.2 W	13.1 W	16.5 W	23.0 W
Flatten t=3.0mm	8.2 W	12.1 W	14.1 W	22.0 W	37.0 W
Round Pipe	9.0 W	12.3 W	15.6 W	29.3 W	45.0 W



## FLATTENING HEAT PIPES



Flattening is another aspect of heat pipes that effect their performance. Often it is necessary to flatten a heat pipe to fit into a desired shape or gap or to increase the contact area of the pipe with the heat. Since flattening reduces the effective cross-sectional area of the round pipe, the thermal capacity is reduced, just as if a smaller diameter pipe was being used. The larger diameter of the starting heat pipe, the larger reduction of thermal capacity is seen when flattening. Also, the larger diameter pipes cannot be flattened to the same ultimate dimension as the smaller pipes without disrupting heat flow altogether. This is also true for bending of pipes. The radius of bending is usually 3-5x the diameter of the heat pipe depending on the pipe diameter and the process of bending the pipe. The potential danger is to collapse the pipe, effectively cutting off vapor and thermal transport.

SIZE OF FLATTED HEAT PIPES			
Diameter (mm)	Thickness (mm)	Width (mm)	Tolerance (mm)
4mm	3	4.65	+/- 0.15
	2.5	5	+/- 0.15
	2	5.23	+/- 0.15
5mm	3.5	5.97	+/- 0.15
	3	6.25	+/- 0.15
	2	6.83	+/- 0.15
6mm	4	7.3	+/- 0.15
	3.5	7.58	+/- 0.15
8mm	6	9.35	+/- 0.15
	5	9.95	+/- 0.15
	4	10.5	+/- 0.15
	3	10.99	+/- 0.15

*Bending radius for heat pipes of different diameters depending on the method of bending.*

### BENDING

#### By Hand:

- 4mm: 4 x diameter
- 6mm: 4 x diameter
- 8mm: 5 x diameter

#### Tooling:

- 4mm: 3 x diameter
- 6mm: 3 x diameter
- 8mm: 4 x diameter

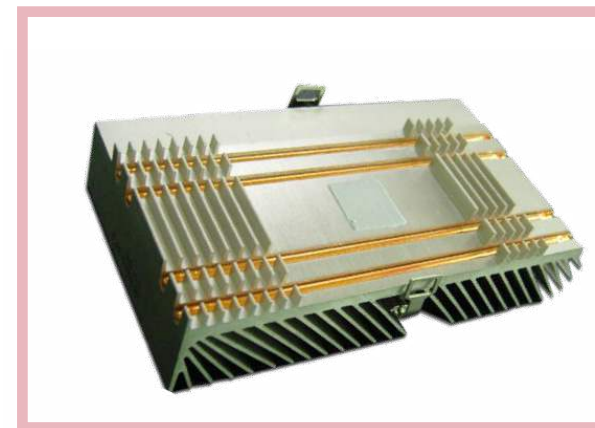

## HEAT PIPE SELECTION GUIDE

### HEAT PIPE ASSEMBLIES

Interfacing heat pipes with plates and heat exchangers is predominately about maximizing contact area while adhering to the flattening and bending guidelines mentioned above. In most cases, the heat pipes are slotted into channels/grooves in the plate to maximize contact. The heat pipe can be secured into the groove using solder or thermal epoxy, which also augments the contact area of the heat pipe. The heat pipe can also be clamped between two plates with matching channels/grooves which are fastened together. In the clamped configuration, thermal grease can be used to increase the contact of the heat pipe to the plates to reduce the thermal resistance of the contact interface, just as the thermal epoxy and solder did in the prior example.

Vapor transports heat from evaporator to condenser. Condensed liquid flows back to evaporator through capillary action.

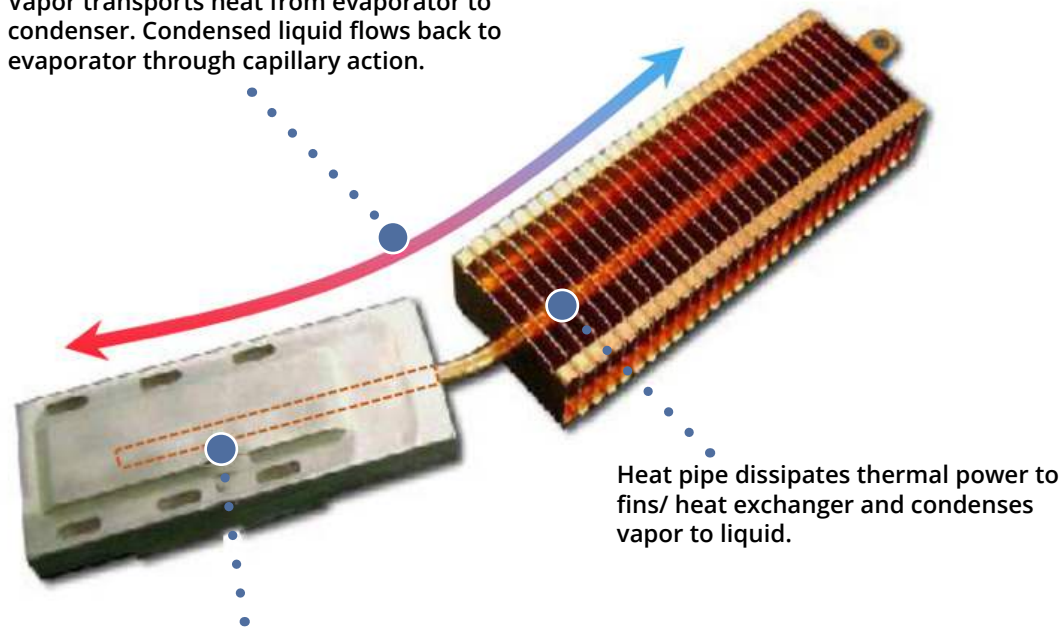

Embedded heat pipe in plate absorbs heat through vaporization of liquid.

### WAKEFIELD-VETTE STANDARD HEAT PIPES

Wakefield-Vette offers individual Heat Pipes through distribution. These most common offerings are a great option for testing, sampling, and validating your heat pipe solution into eventual production.

When building or testing your heat sink assembly please feel free to contact one of Wakefield Vette's authorized distributors to purchase. Always remember to contact us for free consultation on assembly design or parameter questions.

Wakefield-Vette Part Number	Description
121686	Round Heat Pipe 4 x 70mm
121687	Round Heat Pipe 4 x 100mm
121688	Round Heat Pipe 4 x 150mm
110578	Round Heat Pipe 6 x 100mm
110579	Round Heat Pipe 6 x 150mm
110580	Round Heat Pipe 6 x 200mm
110581	Round Heat Pipe 6 x 250mm
110582	Round Heat Pipe 6 x 300mm
121968	Round Heat Pipe 8 x 100mm
110583	Round Heat Pipe 8 x 200mm
110584	Round Heat Pipe 8 x 250mm
110585	Round Heat Pipe 8 x 300mm
121689	Round Heat Pipe 10 x 100mm
121690	Round Heat Pipe 10 x 200mm
121691	Round Heat Pipe 10 x 250mm
121692	Round Heat Pipe 10 x 300mm
121716	Flat Heat Pipe 2.5 x 100mm
121717	Flat Heat Pipe 2.5 x 150mm
121718	Flat Heat Pipe 2.5 x 200mm
121719	Flat Heat Pipe 2.5 x 250mm
121720	Flat Heat Pipe 3 x 100 mm
121721	Flat Heat Pipe 3 x 150 mm
121722	Flat Heat Pipe 3 x 200 mm
121723	Flat Heat Pipe 3 x 250 mm
121724	Flat Heat Pipe 3 x 300 mm
121725	Flat Heat Pipe 4.5 x 100mm
121726	Flat Heat Pipe 4.5 x 150 mm
121727	Flat Heat Pipe 4.5 x 200 mm
121728	Flat Heat Pipe 4.5 x 250 mm
121729	Flat Heat Pipe 4.5 x 300 mm
120231	Ultra Thin 6MM DIA X 1.50MM
120229	Ultra Thin 5MM DIA X 1.00MM



# VAPOR CHAMBER DESIGN GUIDE

## VAPOR CHAMBER INTRODUCTION

**Vapor Chambers** are used to transport heat over a distance with very low thermal resistance. This is very helpful when small heat sources need to be dissipated over a larger area. Vapor chambers are a **Fluid Phase Change application** because they use a closed loop to transfer heat quickly through evaporation and condensation within the chamber. The particular aspect useful in designs is that vapor chambers transport heat in a plane, more effectively "spreading heat" compared to a heat pipe which transports heat over a distance in a straight line.

Vapor chambers, like heat pipes, do not actually dissipate the heat to the environment, but serve to move heat efficiently within a thermal system. A vapor chamber is made from copper plates (top and bottom) with an internal wick structure that is sealed around the perimeter with a small amount of water inside. As heat is applied to the chamber, the water will boil and turn to a gas, which then travels to the colder section of the vapor chamber, where heat is dissipated through an external heat exchanger, where it condenses back to a liquid. It is the evaporating and condensing of the water that form a pumping action to move the water (and thus the heat) from the area of the heat source to all other areas of the vapor chamber.



There are a few types of wick structure that can be used within the vapor chamber, but most commercial chambers are classified as mesh or powder. In both cases, the powder or mesh line the copper plate surfaces to allow water flow to/from all directions within the area of the vapor chamber. Often, when mesh is used as the wick structure, different sized meshes are used together to promote condensation or transport of liquid depending on the void size. Vapor chambers are best used in horizontal orientations. The effects of gravity may vary depending on application and orientation, but one must consider lower performance if used above 15° out of horizontal.

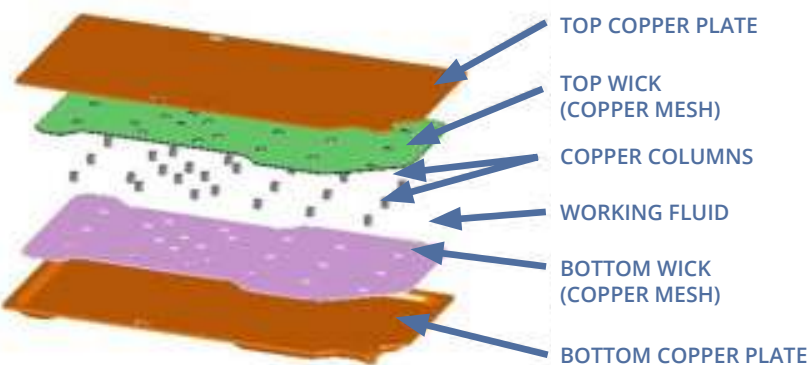

During the manufacturing process copper columns are used throughout the vapor chamber to support the plates that act as the lids and contain the liquid and vapor. The copper mesh is oriented within the chamber pressed against the copper plates. The plates are sealed around the perimeter via diffusion bonding. In some cases, soldering or welding are used, but diffusion bonding allows for the strongest and highest temperature compatible seal for the vapor chamber. The diffusion bonding process also allows the mesh to bond to the copper plates as well.

## WHY USE VAPOR CHAMBERS?

Vapor chambers have proven to be robust and reliable over many years in these types of applications. The next section will give more technical detail on the performance of vapor chambers depending on thickness and area. Many thermal systems benefit from the addition of vapor chambers, especially when heat sources are dense and the final heat exchanger is much larger and the heat from the source must be spread to a larger area effectively to efficiently use the heat exchanger. Computer applications, such as processors, graphics cards and other chip-sets, have high thermally dissipated power in a small area. Fan heat sink combinations used in these applications can offer high-performance dissipation to the ambient, but much of the battle is to spread the heat to the heat exchanger with as little temperature change as possible. Vapor chambers excel at this and can transport large heat loads from small areas with very little temperature difference.

### Vapor chambers are used in many harsh environments such as:

- Computers and Data Centers
- Telecommunications
- Aerospace
- Transportation

### KEY FEATURES

- Material: Copper
- Wick Structure: Copper Mesh
- Light Weight
- Versatile with high thermal performance

## HOW VAPOR CHAMBERS OPERATE

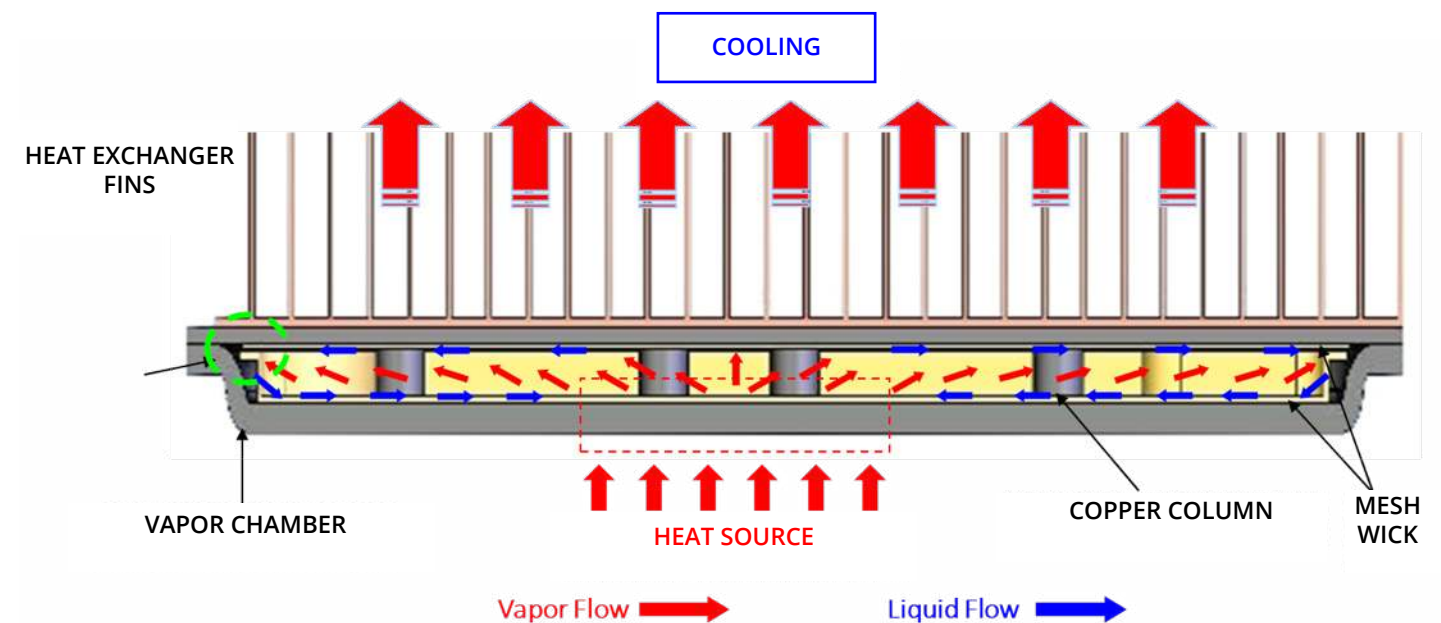

# VAPOR CHAMBER DESIGN GUIDE

## VAPOR CHAMBER BASICS

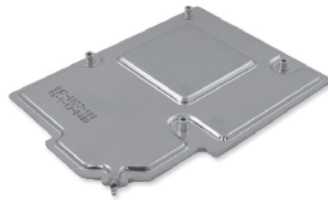

When considering the use of a vapor chamber in your application, it is important to consider the orientation with respect to gravity and overall heat load for the thermal system. The transport of vapor within the vapor chamber is responsible for the thermal conduction from one area to the other. A thicker vapor chamber can transport more vapor, translating into a larger heat carrying capacity. Although vapor chambers can have complex shapes and mounting features, they are not typically bent and integration can be more direct with the heat source than with heat pipes.

### VAPOR CHAMBER BASICS

- Comparison to Heat Pipes
- Transport
- General parameters



VAPOR CHAMBER		HEAT PIPE
2-Phase heat transfer	Theory	2-Phase heat Transfer
2-D heat distribution. Spreading heat by a single vapor chamber. Suitable for large heat flux and high power.	Application	1-D heat distribution. Using one or more heat pipes to spread heat. Suitable for long distance between heat source and heat exchanger.
Complex shape in X and Y direction with pedestal.	Shape	Round, flattened or bent in any direction.
Mounted with through-holes in vapor chamber	Fixtures	Additional fixture plates needed to mount heat pipes.
Direct contact. Mounting pressure to 90PSI	Heat Source Contact	A base plate required to contact the heat source unless flattened/machined.
T=5mm > 400W; T=3mm > 200W; T=1mm > 60W	Qmax	Ø5 > 20W; Ø6 > 40W; Ø8 > 60W
Vapor chamber has larger tooling cost so high volume applications can lower cost to ~2X heat pipe. However, solution may need only 1 vapor chamber compared to many heat pipes and fixture/base plates.	Cost	Lower cost for a single heat pipe, but may also need tooling cost for bending/flattening.

In many applications, the decision to use a vapor chamber is frequently compared to a thermal solution using heat pipes. In both cases, 2-phase transport is used as a vapor moves heat within the chamber or pipe and the liquid is condensed at the heat exchanger and transported back to the heat source. However, the main aspects of applications that differentiate vapor chambers from heat pipes are:

- **High power density:** when the heat source is small but heat generation is large, vapor chambers can more easily transport the heat to a larger area. A heat pipe solution would require multiple pipes, which may be difficult to integrate within the footprint of the heat source.
- **High power:** when the application must dissipate large wattage, a vapor chamber spreads the heat to a large area efficiently with similar temperatures of the chamber surface. This allows more efficient use of the final heat exchanger since hot spots are minimized. Heat pipes can also spread the heat, but unless many are ganged together, the hot spots may still persist.

## VAPOR CHAMBERS THERMAL CAPACITY

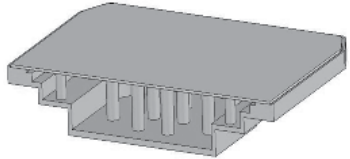

Much like heat pipes, the ultimate dimension in determining heat carrying capacity of a vapor chamber is the volume of the vapor space. This is determined by the thickness and area of the vapor chamber. For most applications, the thickness of the vapor chamber does not exceed 3mm, however pedestals and other surface features can be used to contact specific heat sources while leaving clearance for other board mounted objects. These pedestals can be extended 5mm from the vapor chamber lid plate. Mounting holes can also be integrated within the area of the vapor chamber for better integration with the heat source and locating the heat source at the center of the vapor chamber with good pressure application.

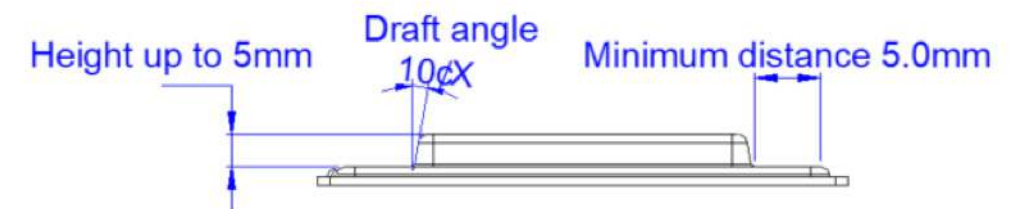

	HEAT CARRYING CAPACITY (Q-MAX) BY VAPOR CHAMBER THICKNESS							
	1.0mm	1.2mm	1.5mm	2.0mm	2.3mm	2.5mm	3.0mm	>3.0mm
45*45	10W	15W	20W	25W	60W	80W	100W	>100W
90*90	40W	50W	80W	100W	150W	180W	250W	>300W
120*120	40W	50W	80W	100W	160W	200W	275W	>300W
150*150			80W	100W	170W	220W	300W	>300W
200*200				100W	175W	225W	>300W	>300W
250*250					180W	240W	>300W	>300W
300*300							>300W	>300W

**Note:** Heat source = 30\*30mm  
This table is for reference. Q-max is related to heat source power density and effectiveness of final heat exchanger.



# VAPOR CHAMBER DESIGN GUIDE

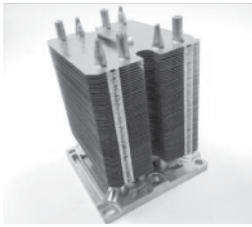

## VAPOR CHAMBER ASSEMBLIES

Interfacing vapor chambers with plates and heat exchangers is predominately about maximizing contact area. In most cases, the vapor chambers are soldered to heat exchanger fins for air cooled applications. The vapor chambers can also be soldered to liquid cold plates to take advantage of spreading the heat before final heat exchange with the liquid. In many cases, the vapor chambers are also integrated with heat pipes to take the heat that has spread in the plane of the vapor chamber and extend it in the vertical dimension to more efficiently interact with cooling fins. Integrating with the heat source is most commonly done with pressure, up to 90 psi, and the use of a thermal grease or other interface material to maximize surface area contact to the source.

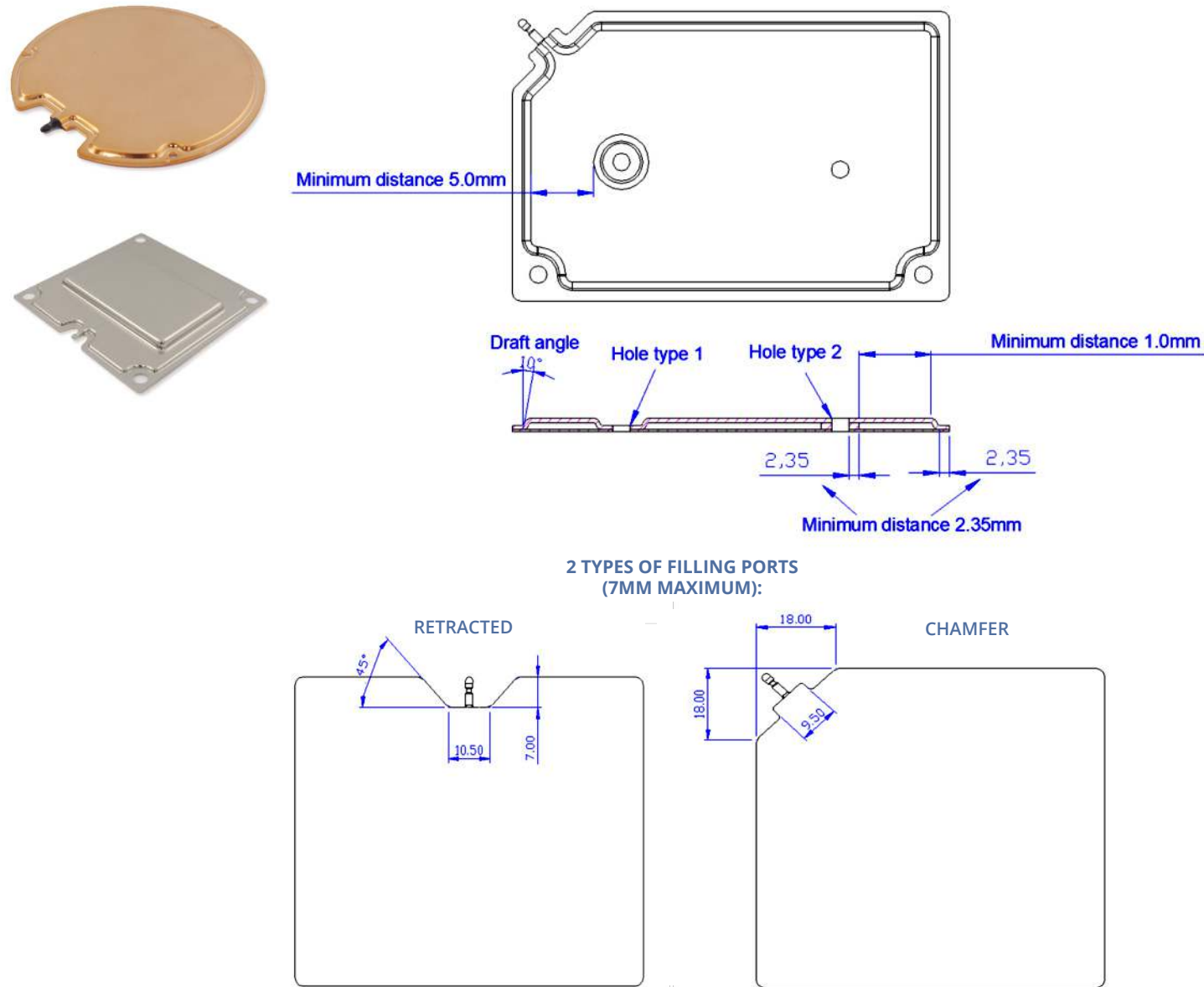

## WAKEFIELD-VETTE STANDARD VAPOR CHAMBERS

Wakefield-Vette offers individual vapor chambers through distribution. These most common offerings are a great option for testing, sampling, and validating your vapor chamber solution into eventual production. When building or testing your heat sink assembly please feel free to contact one of Wakefield-Vette's authorized distributors to purchase. Always remember to contact us for free consultation on assembly design or parameter questions.

WKV Part #	Product Description	Thermal Resistance	Length	Width	Thickness	qMax
VC-1131-8175-517	Standard Vapor Chamber 113.1mm x 81.75mm X 5.17mm	0.145	113.1	81.75	5.7	180W~
VC-90-90-3	Standard Vapor Chamber 90mm x 90mm x 3.00mm	0.143	90	90	3	150W~
VC-106-70-3	Standard Vapor Chamber 106mm x70mm x 3mm	0.150	106	70	3	150W~
VC-106-82-3	Standard Vapor Chamber 106mm x 82mm x 3mm	0.140	106	82	3	150W~

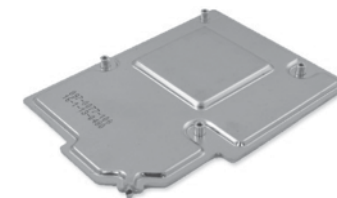

### PART NUMBER VC-1131-8175-517

#### Product Info Description

Dimension(mm): L: 113mm / W: 81.8mm / T: 5.7mm  
Operation Power: 180W~

#### Product Info Details

Thermal Resistance: 0.145°C/W  
Operation Temp: 40~130°C  
Platform : VGA



### PART NUMBER VC-90-90-3

#### Product Info Description

Dimension(mm): L: 90mm / W: 90mm / T: 3mm  
Operation Power: 150W~

#### Product Info Details

Thermal Resistance: 0.143°C/W  
Operation Temp: 40~140°C  
Platform : Intel 2011 Square



### PART NUMBER VC-106-70-3

#### Product Info Description

Dimension(mm): L: 106mm / W: 70mm / T: 3mm  
Operation Power: 150W~

#### Product Info Details

Thermal Resistance: 0.150°C/W  
Operation Temp: 40~140°C  
Platform : Intel 2011 Narrow



### PART NUMBER VC-106-82-3

#### Product Info Description

Dimension(mm): L: 106mm / W: 82mm / T: 3mm  
Operation Power: 150W~

#### Product Info Details

Thermal Resistance: 0.140°C/W  
Operation Temp: 40~140°C  
Platform : Intel 2011 Narrow



# THERMAL INTERFACE PRODUCTS

*Thermal Compounds, Adhesives & Interface Materials* ..... 140-145  
*High Performance Thermal Compound* ..... 140  
*General & Thermal High Performance Epoxy* ..... 146-155



*Cost-effective accessory products that facilitate installation and improve the thermal performance of both standard and custom heat dissipation components. Included are thermal joint compounds; filled epoxy systems; adhesives; thermally conductive insulating wafers, washers, pads and mounting hardware.*

## THERMAL COMPOUNDS, ADHESIVES & INTERFACE MATERIALS

### 120 SERIES

The **120 Series** Silicone Oil-Based Thermal Joint Compound fills the minute air gap between mating surfaces with a grease-like material containing zinc oxide in a silicone oil carrier. It possesses an excellent thermal resistance of only 0.05°C/W for a 0.001 in. film with an area of one square inch. There is no measurable increase in case temperature of a mounted semiconductor on a heat sink after the 6-month stabilization period (Time versus Thermal Resistivity graph below).

TYPICAL VALUES FOR THERMAL RESISTANCE, CASE TO SINK (Øcs) WHEN THERMAL JOINT COMPOUNDS ARE USED

Case Style Characteristics	Mounting Torque in inch • pounds (N•M)	Typical Thermal Resistance (°C/W)
TO-3	8 (0.9)	0.09
TO-66	9 (0.9)	0.14
TO-220	8 (0.9)	0.50
0.19 (4.8) stud x 0.44 (11.2) hex	15 (1.7)	0.16
0.25 (6.4) stud x 0.69 (17.5) hex	30 (3.39)	0.10
0.38 (9.7) stud x 1.06 (26.9) hex	75 (8.47)	0.07
0.50 (12.7) stud x 1.06 (26.9) hex	125 (14.12)	0.07
0.75 (19.1) stud x 1.25 (31.8) hex	600 (67.79)	0.052

120 SERIES - ORDER GUIDE

Series - P/N	Container Size
120-SA	4 gram plastic pak
120-2	2 oz (0.06 kg) jar
120-5	5 oz (0.14 kg) tube
120-8	8 oz (0.23 kg) jar
120-80	5 lb (2.27 kg) can
120-320	20 lb (9.08 kg) can

120 SERIES - THERMAL JOINT COMPOUND

Characteristic	Description
Volume Resistivity	5 X 10 <sup>14</sup> ohm-cm
Dielectric Strength	225 volts/mil
Specific Gravity	2.1 min.
Thermal Conductivity @ 36°C	0.735 W/(m)(K)
	5.1(Btu) (in.)/(hr)(ft <sup>2</sup> )(°F)
Thermal Resistivity (P)	56 (°C)(in.)/watt
Bleed, % after 24 hrs @ 200°C	0.5
Evaporation, % after 24 hrs @ 200°C	0.5
Color	opaque white
Shelf life	5 years
Operating Temperature Range (°C)	-40/+200

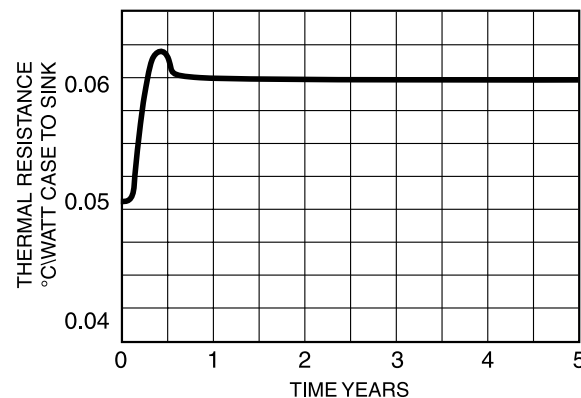

## HIGH PERFORMANCE THERMAL COMPOUND

### 122 SERIES

**122 Series Thermal Joint Compound** is a stable, silicone based, thixotropic paste developed to provide premium performance at an affordable price. It is formulated to significantly reduce contact thermal resistance where power densities are concentrated in devices such as flip chip, reduced die size, and 'overclock' microprocessors. When applied as a thin film between a Wakefield-Vette heat sink and device it possesses superior thermal conductivity compared to traditional 'grease'. It is compatible with automated or manual dispensing methods and is fully RoHS compliant.

122 SERIES THERMAL JOINT COMPOUND

Typical Characteristics	Description
Appearance	Smooth Gray paste
Thermal Conductivity	2.5 W / m °K, 17.3 (Btu) (in.)/(hr) (ft <sup>2</sup> ) (°F)
Thermal Resistance	0.02 °C in 2 / W
Bleed	0.015 wt%, 24 hrs at 200°C
Evaporation	0.150 wt%, 24 hrs at 200°C
Volume Resistivity	1.4 x 10 <sup>10</sup> ohm-cm
Dielectric Strength	225 volts/mil
Specific Gravity	2.23 (gm/cc) at 25°C
Operating Range	-40°C to 205°C
Shelf Life	5 years

122 SERIES - ORDER GUIDE

Series - P/N	Container Size
122-10CC	10cc syringe
122-2	2 oz (0.06 kg) jar
122-30CC	30cc syringe



## THERMAL COMPOUNDS, ADHESIVES & INTERFACE MATERIALS

### 126 SERIES

The **126 Series** is a nontoxic, synthetic, ester-based (nonsilicone) Thermal Joint Compound with metal oxide fillers designed to enhance thermal performance characteristics of plastic and metal package devices exceeding that of silicone-based compounds. Solved are problems associated with contamination of wave solder baths and migration of silicone-based products. Shelf life: 5 years.

126 SERIES THERMAL JOINT COMPOUND

Characteristics	Description
Appearance	Smooth, white homogeneous paste
Solids Content, wt %	65% min
Thermal Conductivity at 36°C	.69 W / m °K, 4.8 (Btu)(in.)/(hr) (ft <sup>2</sup> ) (°F)
Interface Thermal Resistance	0.043°C/W TO-3 at 0.0008 thick film
Bleed, 24 hrs at 200°C, wt%	0.09% max
Evaporation, 24 hrs at 200°C, wt%	0.6 max
Volume Resistivity	2.3 x 10 <sup>12</sup> ohms-cm
Dielectric Strength	200 volts/mil
Specific Gravity @ 60°F	2.93 (gm/cc)
Penetration	280 to 320
Operating Range	-40°C to 200°C

126 SERIES - ORDER GUIDE

Series - P/N	Container Size
126-2	2 oz (0.6 kg) jar
126-4	4 oz (0.11 kg) tube
126-4S	4 oz (0.11 kg) syringe
126-5LB	5 lb (2.27 kg) can



### DELTABOND™ 152



**DeltaBond™ 152** adhesive is ideal for general cementing; thermally bonding semiconductors and components to chassis or heat sinks, while electrically isolating one from the other; fabricating heat sinks or thermal links; and for all permanent bonding of assemblies which require high thermally conductive interfaces. It produces a rigid, high strength bond to most materials when cured. **DeltaBond™ 152** is available in bi-packs, kits, and quarts. Order one bottle of hardener A-4 or B-4 per one quart of **DeltaBond™ 152** separately. Shelf life: 152KA 1 year, all others 2 years.

DELTABOND™ 152

Characteristics	Hardener Type	
	A4	B4
Typical Properties Fully Cured		
Thermal conductivity - W/(m) (°K)	0.836	0.908
(Btu) (in.)/(hr) (ft <sup>2</sup> ) (°F)	5.8	6.3
Thermal resistivity - (°C) (in.) watt	47	42
Bond shear strength 77°F	2,900	2,300
1 in. overlap - psi 125°F	2,200	2,000
etched aluminum to etched aluminum 212°F	400	800
Heat distortion point - °F	130	225
Minimum dielectric strength, v/mil, 0.125 in. sample	400	400
Max operation Continuous temp - °C	65	150
Intermittent	100	190

DELTABOND™ 152

Mixing Proportions and Working Properties		
Characteristics	A4	B4
Parts of hardener per 100 parts of resin by weight	7.5	3.5
*Working Time - at 77°F	45 min	30 min
†Initial cure time 77°F	8 hrs	6 hrs
150°F	45 min	30 min
250°F	20 min	15 min
‡Post-cure time at a temp in °F	4 hrs @200°F	4 hrs @ 200°F
‡Alternate room temp. aging time at 77°F	4 days	4 days
Working consistency (77°F)	viscous liquid	paste
Working viscosity (77°F) cps	25,000	—

#### NOTES:

\* Since the hardener/resin reaction is exothermic, it is important that batch size be matched to hardener speed. Working times given are for approximate batch sizes: A—200 gms, B—200 gms. Larger batch sizes will greatly reduce working time.

\*\* For optimum electrical properties, dry parts for 15 minutes at 150°F (65°C) or 30 minutes at 75°F (24°C) to slowly evaporate the thinner and then final cure for 4 hours at 275°F (135°C).

† After initial cure, material may be handled, removed from fixture, etc., but has not yet achieved full properties and should be room temperature aged or post-cured as shown to achieve full physical and electrical properties.

‡ After initial cure, material may be brought to full physical and electrical properties during post-cure or may be room temperature aged for charted length of time to achieve same full properties.

The information contained herein is based on data believed to be reliable but we do not assume responsibility for accuracy. All such information is used at the customer's own risk, conditions of use being beyond our control.

DELTABOND™ 152

Ordering Guide - Resin and Hardener			
Model Number	Resin		Hardener
	Part No.	Container	Part Number
DeltaBond™ 152	152-1A	Bi-Pack (1 oz)	Included in PIN 152-1 A ("A-4") Type Included in P/N 152-1 B ("B-4") Type Included in P/N 152-KA A-4 (0.316 lb), B-4 (0.14 lb), (order 1 only)
	152-1B	Bi-Pack (1 oz)	
	152-KA	Kit (7 oz Resin, 0.5 oz Hardener)	
	152-Q	1 quart (4 lbs)	
All hardener part numbers: A-4, B-4			

## THERMAL COMPOUNDS, ADHESIVES & INTERFACE MATERIALS



### DELTACAST™ 153

**DeltaCast™ 153** is a pourable casting resin having thermal expansion characteristics similar to aluminum and copper allowing assemblies to operate over a very wide temperature range. Ideal for encapsulating components and assemblies, this series' major advantages and uses include potted systems (virtually indestructible), protecting components and systems from moisture and contaminants, securing proprietary circuitry, mechanical support of devices, removal of heat from hot components and the assembly equalizing temperatures, and high voltage isolation. **DeltaCast™ 153** is available in quarts and gallons. Order one bottle of hardener A4 or B4 per one quart of **DeltaCast™ 153** separately. Shelf life: 2 years.

DELTACAST™153		
Characteristics	Hardener Type	
	A4	B4
Typical Properties Fully Cured		
Thermal conductivity - W/(m) (°K)	0.836	0.908
(Btu) (in.)/(hr) (ft²) (°F)	5.8	6.3
Thermal resistivity - (°C) (in.) watt	47	42
Bond shear strength 77°F	2,500	1,900
1 in. overlap - psi 125°F etched aluminum to etched aluminum 212°F	—	—
Heat distortion point - °F	130	225
Minimum dielectric strength, v/mil, 0.125 in. sample	400	400
Max operation Continuous temp - °C	65	150
Intermittent	100	190

DELTACAST™153		
Mixing Proportions and Working Properties		
Characteristics	A4	B4
Parts of hardener per 100 parts of resin by weight	7.5	3.5
*Working Time - at 77°F	45 min	30 min
† Initial cure time 77°F	8 hrs	6 hrs
150°F	45 min	30 min
250°F	20 min	15 min
‡Post-cure time at a temp in °F	4 hrs @200°F	4 hrs @ 200°F
‡Alternate room temp. aging time at 77°F	4 days	4 days
Working consistency (77°F)	heavy liquid	viscous liquid
Working viscosity (77°F) cps	10,000	30,000

DELTACAST™153			
Ordering Guide - Resin and Hardener			
Model Number	Resin		Hardener
	Part No.	Container	Part Number
DeltaCast™ 153	153-Q	1 quart (4 lbs)	A-4 (0.316 lb), B-4 (0.14 lb), (order 1 only)
All hardener part numbers: A-4, B-4			

### DELTABOND™ 154

**DeltaBond™ 154** is a medium viscosity, aluminum-filled resin with the best thermal conductivity of this series. It is, however, neither a good electrical insulator nor conductor. Its principal application is that of a good thermal mechanical adhesive for applications such as bonding fins to base plates or structural mounting blocks or brackets to heat sinks. Order one bottle of hardener A4 or B4 per one quart of **DeltaBond™ 154** separately. Shelf life: 2 years.



DELTABOND™ 154		
Mixing Proportions and Working Properties		
Characteristics	A4	B4
Parts of hardener per 100 parts of resin by weight	11.0	4.5
*Working Time - at 77°F	45 min	30 min
† Initial cure time 77°F	8 hrs	6 hrs
150°F	45 min	30 min
250°F	20 min	15 min
‡Post-cure time at a temp in °F	4 hrs @200°F	4 hrs @ 200°F
‡Alternate room temp. aging time at 77°F	4 days	4 days
Working consistency (77°F)	viscous liquid	paste
Working viscosity (77°F) cps	25,000	—

DELTABOND™ 154		
Characteristics	Hardener Type	
Typical Properties Fully Cured	A4	B4
Thermal conductivity - W/(m) (°K)	1.053	1.154
(Btu) (in.)/(hr) (ft²) (°F)	7.3	8.0
Thermal resistivity - (°C) (in.) watt	37	34
Bond shear strength 77°F	3,000	2,400
1 in. overlap - psi 125°F	2,300	2,100
etched aluminum to etched aluminum 212°F	500	800
Heat distortion point - °F	130	225
Minimum dielectric strength, v/mil, 0.125 in. sample	NA*	NA*
Max operation Continuous temp - °C	65	150
Intermittent	100	190

### DELTABOND™ 154

DELTABOND™154			
Ordering Guide - Resin and Hardener			
Model Number	Resin		Hardener
	Part No.	Container	Part Number
DeltaBond™	154-Q1	quart (2.5 lbs)	A-4 (0.316 lb), B-4 (0.14 lb), (order 1 only)
All hardener part numbers: A-4, B-4			



### DELTABOND™ 155

**DeltaBond™ 155** is an epoxy adhesive formulated for use within the semiconductor industry. An easy to mix spread thixotropic paste, it offers high heat transfer, low shrinkage, and a coefficient of thermal expansion comparable to that of copper and aluminum. This adhesive is principally used to form thermally conductive joints in fabricated heat sinks and between heat sinks and power devices. When used to bond semiconductors to heat sinks, it also serves as an electrical insulator. Its strong bond to a wide variety of substrates resists severe temperature cycling. **DeltaBond™ 155** is only available in kit size. Simply squeeze out equal lengths and mix to uniform color. Shelf life: 1 year.

DELTABOND™ 155	
Characteristics	Hardener Type
Typical Properties Fully Cured	DeltaBond™155
Thermal conductivity - W/(m) (°K)	0.836
(Btu) (in.)/(hr) (ft²) (°F)	5.8
Thermal resistivity - (°C) (in.) watt	47
Bond shear strength 77°F	2,600
1 in. overlap - psi 125°F etched aluminum to etched aluminum 212°F	—
Heat distortion point - °F	130
Minimum dielectric strength, v/mil, 0.125 in. sample	400
Max operation Continuous temp - °C	65
Intermittent	100

DELTABOND™ 155		
Mixing Proportions and Working Properties		
Parts of hardener per 100 parts of resin	by volume 100	
*Working Time - at 77°F	90 min	
†Initial cure time 77°F	8 hrs	
150°F	45 min	
250°F	20 min	
‡Post-cure time at a temp in °F	4 hrs @ 200°F	
‡Alternate room temp. aging time at 77°F	4 days	
Working consistency (77°F)	paste	
Working viscosity (77°F) cps	paste	

DELTABOND™ 155			
Ordering Guide - Resin and Hardener			
Model Number	Resin	Hardener	
	Part No.	Container	Part Number
DeltaBond™ 155	155 Kit	(3 oz resin, 3 oz hardener)	Included in P/N 155

#### NOTES:

\* Since the hardener/resin reaction is exothermic, it is important that batch size be matched to hardener speed. Working times given are for approximate batch sizes: A—200 gms, B—200 gms. Larger batch sizes will greatly reduce working time.

† After initial cure, material may be handled, removed from fixture, etc., but has not yet achieved full properties and should be room temperature aged or post-cured as shown to achieve full physical and electrical properties.

‡ After initial cure, material may be brought to full physical and electrical properties during post-cure or may be room temperature aged for charted length of time to achieve same full properties.

The information contained herein is based on data believed to be reliable but we do not assume responsibility for accuracy. All such information is used at the customer's own risk, conditions of use being beyond our control.



# THERMAL COMPOUNDS, ADHESIVES & INTERFACE MATERIALS

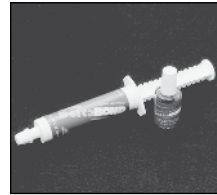

## DELTABOND™ 156

**DeltaBond™ 156** Thermally Conductive Adhesive is a modified acrylic adhesive designed for permanent mounting on components where heat must be effectively transmitted. Recommended for electromechanical assemblies to bond components and dissipate heat, it replaces mechanical fasteners and compressible pads, silicone grease, and epoxies; eliminates air entrapment, and other variables related to epoxy mixing. This soft paste requires no mixing and flows easily to allow thin bond lines. Primer activated, cure begins upon assembly. DeltaBond™ Activator fixtures at room temperature in less than 5 minutes. Full strength is developed in 4 to 12 hours and fillets become dry to the touch in 24 hours. It is not recommended to use this durable adhesive without the use of DeltaBond™ Activator. **DeltaBond™ 156** is available in kit size; order 156-K (25 ml Syringe and Activator Kit). Shelf life: 1 year.

DELTABOND™ 156		
Characteristics		
Typical Properties Fully Cured	Description	
Test	Results	ASTM
Temperature Range	-65 to 300°F (-54 to 149°C) 300°F to (177°C) Intermittent	
Tensile Strength, at break	2360 psi	D638
Modulus	233,000 psi	D638
Elongation, at break	7.75%	D638
Outgassing	2.5% TLM	E595
Coefficient of Thermal Expansion	0.05% CVMC	
Tensile Shear	7.1 x 10 <sup>-4</sup> (cm/cm°C)	D1002
Thermal Conductivity, K (absolute at 86°F (30°C))	2500psi 3.47 Btu x in./hr ft <sup>2</sup> °F (0.50 W/m °C)	

Note: The absolute thermal conductivity test was developed specifically for measuring thermal properties of thin film adhesive bonds.

DELTABOND™ 156		
Typical Electrical Properties		
Test	Results	ASTM
Dielectric Strength	220 volts/mil	D149
Dielectric Constant, 77°F (25°C)		D150
100 Hz	14.92	
1000 Hz	14.26	
1MM Hz	12.34	
Dissipation Factor, 77°F (25°C)		D150
100 Hz	0.05	
1000 Hz	0.03	
1MM Hz	0.06	
Volume Resistivity	5.2x10 <sup>11</sup> (ohms-cm)	D257
Surface Resistivity	8.6 x 10 <sup>13</sup> (ohms)	D257

Note: DeltaBond™ Thermally Conductive Adhesive-High Strength contains a metallic filler which, in certain applications, may have an effect on electrical properties. Therefore, test each particular application to ensure that electrical properties are as required.

DELTABOND™ 156			
Ordering Guide - Resin and Hardener			
Model Number	Resin		Hardener
	Part No.	Container	Part Number
DeltaBond™ 156	156-K	Resin Kit Hardener Syringe - 0.85 fl oz - 25 ml - 2 oz net/0.44 oz fl contents bottle -12ml	Included in kit hardener with brush applicator - 4.2 oz total wt/kt

### NOTES:

- \* Since the hardener/resin reaction is exothermic, it is important that batch size be matched to hardener speed. Working times given are for approximate batch sizes: A—200 gms, B—200 gms. Larger batch sizes will greatly reduce working time.
- † After initial cure, material may be handled, removed from fixture, etc., but has not yet achieved full properties and should be room temperature aged or post-cured as shown to achieve full physical and electrical properties.
- ‡ After initial cure, material may be brought to full physical and electrical properties during post-cure or may be room temperature aged for charted length of time to achieve same full properties.

The information contained herein is based on data believed to be reliable but we do not assume responsibility for accuracy. All such information is used at the customer's own risk, conditions of use being beyond our control.

## DELTAPADS™ THERMALLY CONDUCTIVE INSULATORS 173 & 174 SERIES

TO-3, TO-66, TO-220, DO-4, DO-5 SHEET

## GREASELESS THERMALLY CONDUCTIVE KAPTON® REINFORCED INSULATORS 175 SERIES



The **173, 174, and 175 Series** are highly efficient thermally conductive insulators designed for semiconductor interface to heat sinks. Their properties eliminate messy concerns associated with thermal greases.

Characteristics	DeltaPads™ 173-7 Series	DeltaPads™ 173-9 Series	DeltaPads™ 174-9 Series	Kapton® 175-6 Series	Test Method
Material Thickness	0.007 in.	0.009 in.	0.009 in.	0.006 in.	Micrometer
Color	Gray	Gray	Tan	Gray	Visual
Tear Strength, lb/in. Typical100	100	100	100	ASTM 0624	
Volume Resistivity, megohm-cm, Minimum Normal	1.0 x 10 <sup>9</sup>	1.0 x 10 <sup>9</sup>	1.0 x 10 <sup>13</sup>	1 x 10 <sup>13</sup>	ASTM D257
Breakdown Voltage, Minimum	4,000	5,000	5,000	6,000	ASTM 0149
Dielectric Constant at 60 Hz and 100 V Maximum	2.70	2.40	2.50	5.5 @ 1,000 Hz	ASTM D 150
Continuous Use Temperature, °C	-60/+200	-60/+200	-60/+200	-60/+200	-
Thermal Conductivity, cal/cm sec. °C, Minimum	3 x 10 <sup>-3</sup>	3 x 10 <sup>-3</sup>	1 x 10 <sup>-2</sup>	1.2 x 10 <sup>-3</sup>	-
Thermal Resistance (TO-3), 1 in. <sup>2</sup> °C/W	0.33	0.50	0.25	0.40	-
Recommended Mounting Pressure, lb/in. <sup>2</sup>	350/550	350/550	350/550	350/550	Formula*

$$*P \text{ (pressure in psi)} = \frac{T \text{ (torque [in.-lb]} \times N \text{ (number of fasteners)}}{0.2 \times D \text{ (Thread Dia)} \times A \text{ (contact surface area square inches)}}$$

173-7 Series		173-9 Series	174-9 Series	175-6 Series
No Adhesive	Adhesive Backing	No Adhesive	No Adhesive	Greaseless
-	-	173-9-210P	-	175-6-210P
173-7-220P	-	-	-	175-6-220P
173-7-230P	-	173-9-230P	-	175-6-230P
173-7-240P	173-7-240A	173-9-240P	-	175-6-240P
-	-	-	-	175-6-250P
-	-	-	-	175-6-280P
-	-	-	174-9-310P	175-6-310P
-	-	-	-	175-6-320P
-	-	-	-	175-6-330P
-	-	-	-	175-6-410P
-	-	-	-	175-6-610P
173-7-1212P	-	173-9-1212P	174-9-1212P	-

### MECHANICAL DIMENSIONS

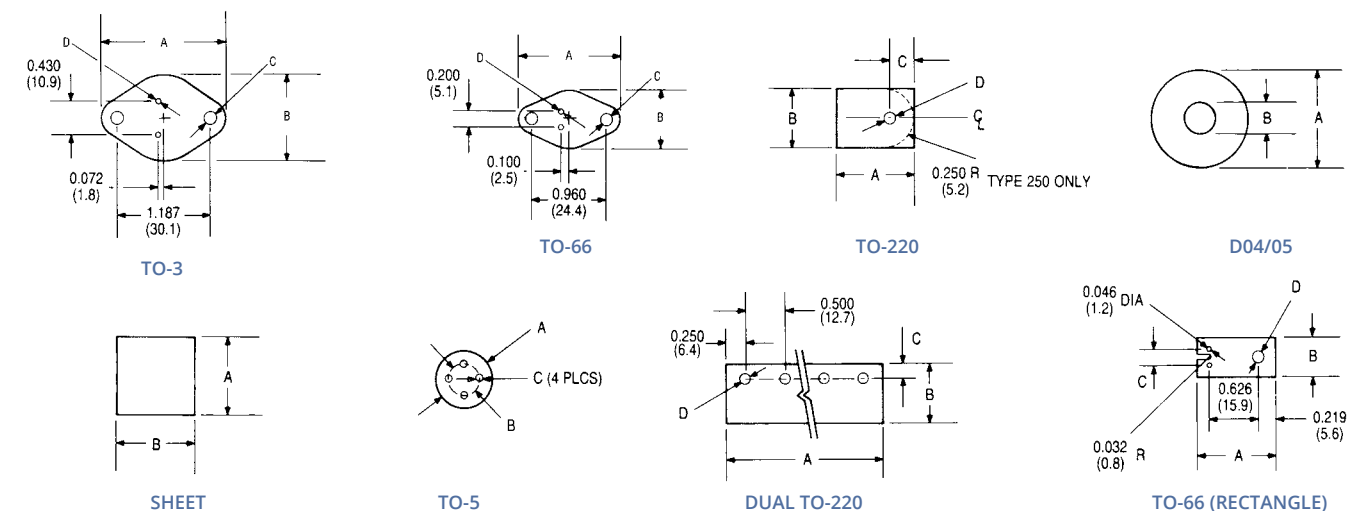

Dimensions: in. (mm)

Contact us: (603) 635-2800

## GENERAL & THERMAL HIGH PERFORMANCE EPOXY



### BONDATHERM™



#### KEY FEATURES OF THE BONDATHERM EQUALIZER KITS:

- Eliminates improper ratios and mixing errors
- Reduces material waste
- Eliminates employee contact with resins
- Eliminates messy hand mixing and transferring
- Increases productivity
- Resins are protected from moisture contamination

BondaTherm™

Wakefield-Vette Part Number	Description	Packaging
BT-101-50M BT-102-50M BT-301-50M BT-301-200M	Non-Sag 5 Minute BondaTherm Epoxy Adhesive Toughened, Flexible Adhesive System Fast Curing Thermally Conductive Adhesive Fast Curing Thermally Conductive Adhesive	50ml Dual Cartridges 50ml Dual Cartridges 50ml Dual Cartridges 200ml Dual Cartridges
BT-01-50M BT-01-200M BT-02-50M BT-02-200M	BondaTherm Equalizer Dispense Gun (50ml) BondaTherm Equalizer Dispense Gun (200ml) BondaTherm Equalizer Static Mixer (50ml) BondaTherm Equalizer Static Mixer (200ml)	- - - -
BT-101-50M-EQZ BT-102-50M-EQZ BT-301-50M-EQZ BT-301-200M-EQZ	Two Dual Cartridges (BT-101-50M), One Gun (BT-01-50M), Three Mixers (BT-02-50M) Two Dual Cartridges (BT-102-50M), One Gun (BT-01-50M), Three Mixers (BT-02-50M) Two Dual Cartridges (BT-301-50M), One Gun (BT-01-50M), Three Mixers (BT-02-50M) Two Dual Cartridges (BT-301-200M), One Gun (BT-01-200M), Three Mixers (BT-02-200M)	Kit Kit Kit Kit
BT-103-50M BT-302-50M	5 Minute Clear Bondatherm Epoxy Adhesive Fast Curing Aluminum Filled Bondatherm Epoxy Adhesive	50ml Dual Cartridges 50ml Dual Cartridges
BT-401-H BT-402-H BT-403-H	Silver Filled Bondatherm 2 gram Epoxy Hinge Packs Thermally Conductive Epoxy Potting UL Listed 100 gram Bondatherm Hinge Pack Aluminum Filled Bondatherm Epoxy Adhesive for Heat Sinks 100 gram Hinge Pack	2 gram hinge pack 100 gram hinge pack 100 gram hinge pack

### BONDATHERM™ CARTRIDGES BT-101-50M



These high bond strength adhesives are clear 100% solids, two component, non-sag adhesives with a quick setting time of 5–46 minutes at room temperature. They are excellent for bonding plated metals, pewter, glass, wood, ceramic, felt, cement, gem stones, most plastics and rubbers. These adhesives were tested in our laboratory for flame retardancy properties. According to our test results they meet the requirements of UL94HB.

#### APPLICATIONS:

These unique adhesives are ideally suited for a wide range of electronic, electrical, industrial, structural, and jewelry applications. These adhesives are also an excellent choice for field repairs. They are offered in the popular BondaTherm Equalizer Kit dual barrel cartridge dispensing system and bulk packaging.

### BONDATHERM™ CARTRIDGES BT-101-50M

#### FEATURES

- Non-sag consistency
- High bond strength
- Fast room temperature cure – three speeds to choose from
- Water & chemical resistance
- Outstanding thermal shock resistance
- 1:1 mix ratio
- Impact resistance

#### INSTRUCTIONS FOR USE:

1. Thoroughly mix equal parts of resin to catalyst by weight or volume.
2. Apply evenly to both surface(s) to be bonded.
3. Application to the substrates should be made within five minutes. Larger quantities and/or higher temperatures will reduce the working time. Avoid mixing large quantities and/or at high temperature due to the possibility of creating a high exothermic temperature.
4. Join the coated surfaces. Allow to cure at 60°F (16°C) or higher until adhesive is set. Heat may be added up to 200°F (93°C) to accelerate the cure.
5. Avoid moving parts during cure. Pressure to the substrates is recommended. Maximum shear strength is obtained with a 3-5 mil bond line.

Specifications	
Color	Semi-transparent (available in black)
Mix ratio by volume	1:01
Mixed viscosity, 25°C cps*	Non-Sag 100
Solids content, %	100
Specific gravity, 25°C	1.15
Shore D hardness	
10-3005NS	86
10-3020NS	72
10-3046NS	65
Work Life, 25°C, minutes	
10-3005NS	3-5
10-3020NS	10-15
10-3046NS	25-30
Handling time, 25°C, minutes	
10-3005NS	15-20
10-3020NS	30-35
10-3046NS	55-60
Cure time, 25°C, hours	24-48
Coefficient of thermal expansion (in/in/°C)	60x10 <sup>-6</sup>
Operating temperature range, °C	50 to *130
Dielectric strength, V/mil	420
Izod Impact ft-lb/in	2.7
Dielectric constant, 1KHz at 25°C	4
Dissipation factor, 1KHz at 25°C	0.017
Volume resistivity, ohm-cm at 25°C	2.0 x 10 <sup>14</sup>
Shear strength, psi	
Aluminum (etched)	1,500
Cold rolled steel	1,000
Copper	960
Brass	725
Stainless Steel	750
Galvanized Steel	900
ABS	500
PVC	335
Polycarbonate	250
Compression strength, psi	8,500
<b>Adhesive coverage:</b> a .005-inch bond line will yield approximately 320 sq. ft./gallon	

## GENERAL & THERMAL HIGH PERFORMANCE EPOXY



### BT-102-50M BONDATHERM™ CARTRIDGES

A two component system that forms strong structural bonds at room temperature. This unique adhesive system provides high peel and shear strengths. This is excellent for bonding many metals and woods, most plastics and rubbers and masonry products.

**BT-102-50M** is a toughened, flexible, and impact resistant epoxy adhesive. **BT-102-50M** is a two component system that forms strong structural bonds at room temperature. This unique adhesive system provides high peel and shear strengths. **BT-102-50M** is excellent for bonding many metals and woods, most plastics and rubbers and masonry products. This system is designed for electronic, aerospace and other demanding industrial applications. This product is available in the popular BondaTherm Equalizer dual barrel cartridge system.

FEATURES	
• Impact resistant	
• Excellent electrical insulator	
• High peel and shear	
• Outstanding structural bonds	
• Convenient 1:1 Ratio	
• Retention of strength after environmental aging	

Typical Specifications	
Mixed viscosity, 25°C, cps	150,000
Specific gravity, 25°C,	
Resin	1.32
Catalyst	1.2
Gel time, 100 grams, 25°C	70 minutes
Tensile shear strength, psi	2,600
Durometer, shore D	70
Dielectric strength, V/mil	410
Dielectric constant, 60 Hz	4.4
Dissipation factor, 60 Hz	0.02
Volume resistivity, ohm-cm	1.1 x 10 <sup>15</sup>
Thermal conductivity, btu-in/hr-ft <sup>2</sup> -°F	4
Coefficient of thermal expansion, per °C	10 x 10 <sup>-5</sup>
<b>Adhesive coverage:</b> a .005-inch bond line will yield approximately 320 sq. ft./gallon	

#### INSTRUCTIONS FOR USE:

- Surfaces must be clean and grease free. Use an oil free solvent such as acetone to wipe surfaces. Adhesion can be substantially increased by abrading the surfaces to be bonded with emery cloth, sand paper, carbide grinding tools, and sand blasting. A roughened, porous surface will produce the best results. Any oxidized metal films should be removed just prior to application of the epoxy adhesive mixture.
- Thoroughly mix equal parts of resin and catalyst by volume.
- Apply mixed product evenly to both surfaces.
- Join the adhesive coated surfaces within 60 minutes of mixing resin and catalyst.
- Cure according to one of the following schedules:
 

77°F	24-48 hours
150°F	2 hours
180°F	1 hour
200°F	30 minutes

#### STORAGE, HANDLING, AND AVAILABILITY:

- Store in a cool, dry place in original containers.
- Keep containers closed and stir well before using.

### BONDATHERM™ CARTRIDGES

### BT-301-50M & BT-301-200M



The **BT-301-50M** and **BT-301-200M** have simple 1:1 mix ratios and develop a 1,400 psi Lap Shear strength (aluminum to aluminum) in four hours at room temperature. After just twenty four hours the strength is over 2,200 psi. This is perfect for any thermally conductive applications. Both cartridges are a two component fast curing thermally conductive epoxy adhesive.

These products are specifically formulated for use in the convenient BondaTherm Equalizer dual barrel cartridge system. The **BT-301-50M** and **BT-301-200M** offer fast heat dissipation for a wide range of electronic applications. The black resin and white hardener provide an excellent visual indication of a complete mix.

FEATURES	
• Fast room temperature cure	
• Thermally conductive	
• Forms strong bonds to a variety of substrates	
• Electrically insulating	
• Vibration and impact resistant	

Typical Properties	
Color	
Resin	Black
Hardener	White
Mixed	Dark Gray
Viscosity, @25°C, cps	
Resin	70,000
Hardener	70,000
Specific Gravity, @25°C	
Resin	1.5
Hardener	1.5
Gel Time, 25°C, 15 grams	15 minutes
Durometer, Shore D	
@25°C	80
@70°C	50
Lapshear Strength (Al to Al), psi	
After 4 hours	1,413
After 24 hours	2,231
Thermal Conductivity, W/m - °K	1.04
Dielectric Strength, V/mil	440
Dielectric Constant, 25°C, 100Hz	5.3
Volume Resistivity, ohm-cm, 25°C	2.4 x 10 <sup>12</sup>
Coefficient of Thermal Expansion, ppm/°C	
Below Tg	45
Above Tg	175
Operating Temperature, °C	-40 to +120

#### INSTRUCTIONS FOR USE:

- Surfaces must be clean and grease free. Use an oil free solvent such as acetone to wipe surfaces. Adhesion can be substantially increased by abrading the surfaces to be bonded with emery cloth, sand paper, carbide grinding tools, and sand blasting. A roughened, porous surface will produce the best results. Any oxidized metal films should be removed just prior to application of the epoxy adhesive mixture.
- Dispense material from BondaTherm Equalizer. Apply mixed product to substrate to be bonded.
- Join substrates within 3-5 minutes.
- Cure according to one of the following schedules:
 

25°C	2-4 hours
65°C	< 10 minutes

#### STORAGE, HANDLING AND AVAILABILITY:

- Store in a cool, dry place in original containers.
- Please read and understand the Safety Data Sheet (SDS) before using this product.

#### NOTES:

- At room temperature, the BT-301-50M and BT-301-200M will reach handle cure within 1-2 hours. The lap shear strength is 1,413 psi after 4 hours.
- This product is an adhesive and is not designed for potting and encapsulating applications. The BT-301-50M and BT-301-200M are fast reacting epoxy systems and they will create a high exothermic temperature in large mass sizes (avoid mass sizes greater than 25 grams).



## GENERAL & THERMAL HIGH PERFORMANCE EPOXY



### BT-103-50M BONDATHERM™ CARTRIDGES

These high bond strength adhesives are clear 100% solids, two component, low viscosity adhesives with a quick setting time of 5-46 minutes at room temperature. They are excellent for bonding plated metals, pewter, glass, wood, ceramic, felt, cement, gem stones, most plastics, and rubbers. These adhesives were tested in our laboratory for flame retardancy properties. According to our test results they meet the requirements of UL94HB.

These unique adhesives are ideally suited for a wide range of electronic, electrical, industrial, structural, and jewelry applications. These adhesives are also an excellent choice for field repairs. They are offered in the popular TriggerBond® dual barrel cartridge dispensing system and bulk packaging.

#### FEATURES

- High bond strength
- Outstanding thermal shock resistance
- Water and chemical resistance
- Impact resistance
- 1:1 mix ratio
- Fast room temperature cure – three speeds to choose from

#### INSTRUCTIONS FOR USE:

1. Thoroughly mix equal parts of resin to catalyst by weight or volume.
2. Apply evenly to both surface(s) to be bonded.
3. Application to the substrates should be made within five minutes. Larger quantities and/or higher temperatures will reduce the working time.
4. Avoid mixing large quantities and/or at high temperature due to the possibility of creating a high exothermic temperature.
5. Join the coated surfaces. Allow to cure at 60°F (16°C) or higher until adhesive is set. Heat may be added up to 200°F (93°C) to accelerate the cure.
6. Avoid moving parts during cure. Pressure to the substrates is recommended. Maximum shear strength is obtained with a 3-5 mil bond line.

Typical Specifications (10-3005)	
Color	Clear (available in black)
Mix ratio by volume	1:01
Mixed viscosity, 25°C cps * Solids Content, %	12,000 100
Specific gravity, 25°C Shore D hardness	1.15 86 72 65
Work Life, 25°C, minutes	3-5 10-15 25-30
Handling time, 25°C, minutes	15-20 30-35 55-60
Cure time, 25°C, hours	24-48
Coefficient of thermal expansion (in/in/°C)	60x10 <sup>-6</sup>
Operating temperature range, °C Dielectric strength V/mil	50 to 130 420
Izod Impact, ft-lb/in. Dielectric constant, 1KHz at 25°C	2.7 4.00
Dissipation factor, 1KHZ at 25°C Volume resistivity, ohm-cm at 25°C Shear strength, psi	.017 2.0 x 10 <sup>14</sup>
Aluminum (etched) Cold rolled	1,500
Steel Copper	1,000
Brass	960
Stainless Steel	725
Galvanized Steel	750
ABS	900
PVC	500
Polycarbonate	335
Compression strength, psi	250
<b>Adhesive coverage:</b> a .005-inch bond line will yield approximately 320 sq. ft./gallon	

### BONDATHERM HARDWARE

Wakefield-Vette Part Number	Description
BT-01-50M	BondaTherm Equalizer Dispense Gun (50ml)
BT-01-200M	BondaTherm Equalizer Dispense Gun (200ml)
BT-02-50M	BondaTherm Equalizer Static Mixer (50ml)
BT-02-200M	BondaTherm Equalizer Static Mixer (200ml)

#### BONDATHERM EQUALIZER GUN



### BT-01-50M BONDATHERM™ CARTRIDGES

FOR USE W/ 200ML CARTRIDGES

### BT-01-200M



#### BONDATHERM EQUALIZER STATIC MIXERS



### BT-02-50M FOR USE W/ 50ML CARTRIDGES

FOR USE W/ 200ML CARTRIDGES

### BT-01-200M



## GENERAL & THERMAL HIGH PERFORMANCE EPOXY

### BONDATHERM EQUALIZER KIT™

Wakefield-Vette Part Number	Description	Packaging
BT-101-50M-EQZ	Two Dual Cartridges (BT-101-50M), One Gun (BT-01-50M), Three Mixers (BT-02-50M)	Kit
BT-102-50M-EQZ	Two Dual Cartridges (BT-102-50M), One Gun (BT-01-50M), Three Mixers (BT-02-50M)	Kit
BT-301-50M-EQZ	Two Dual Cartridges (BT-301-50M), One Gun (BT-01-50M), Three Mixers (BT-02-50M)	Kit
BT-301-200M-EQZ	Two Dual Cartridges (BT-301-200M), One Gun (BT-01-200M), Three Mixers (BT-02-200M)	Kit

### (2) Dual Cartridges, (1) Dispense Gun, (3) Static Mixers



### BONDATHERM HINGE PACKS

### BT-401-H



**BT-401-H** is a two component epoxy adhesive filled with silver. This electrically conductive epoxy resin formulation offers continuity of conductivity with an electrical resistivity value of less than  $1 \times 10^{-4}$  ohm-cm. 40-3900 is also well known for its wide operating temperature range, -50 to + 170°C.

**BT-401-H** is specifically designed for adhesive bonding in microelectronic and optoelectronic applications. Due to its excellent continuity, it has also been used extensively in applications such as micro-wave EMI and RFI shielding, in the assembly or repair of printed circuit boards, wave guides, electronic modules, flat cable, high frequency shields, connectors, circuitry, and as a cold solder.

**BT-401-H** is formulated with pure silver (no alloys) and is designed in a convenient 1:1 mix ratio. Both the resin and hardener have silver powder dispersed.

#### FEATURES

- Electrically conductive
- Thermally conductive
- Room temperature cure
- Easy 1:1 mix ratio
- Good bond strength

#### STORAGE, HANDLING, AND AVAILABILITY:

- BT-401-H Resin and hardener should be stored at 25°C in original tightly sealed containers. Expected shelf life is twelve months in original unopened containers.
- Filler settling is common with these products. Gently stir resin and hardener before using to make sure fillers are evenly dispersed.

Typical Specifications	
Mix Ratio, by Weight	1:1
Color	Silver
Mixed Viscosity	Creamy Paste
Pot Life, 100 gram mass @ 25°C	1 Hour
Specific Gravity, 25°C	
Resin	2.98
Hardener	1.8
Hardness, Shore D	70
Thermal Conductivity, W/m- °K	7.93
Tensile Lapshear, psi (Al to Al)	700
Flexural Strength, psi	10,200
Volume Resistivity, ohm-cm	0.0001
Operating Temp. Range, °C	-50 to +170
Cure Schedule	a) 24 hours @ 25°C b) 1 hour @ 65°C c) 15 minutes @ 90°C

## GENERAL & THERMAL HIGH PERFORMANCE EPOXY



### BT-402-H

#### BONDATHERM HINGE PACKS

This system has been formulated to meet the stringent non-burning requirements of UL94 V-0. **BT-402-H** Black Epoxy is used with Catalyst 190 and are listed with Underwriter's Laboratory for passing UL94 V-0. This system offers excellent heat transfer, low shrinkage, and outstanding insulation properties. **BT-402-H** Black with Catalyst 190 passes NASA's outgassing requirements per ASTM E595-07. Other Catalyst's are available as well (30, 150).

Typical applications for **BT-402-H** include encapsulating power supplies, transformers, coils, insulators, and sensors. This system is an excellent choice for applications requiring high thermal conductivity and flame retardancy.

Typical Specifications	
Viscosity @ 25°C cps, Resin	60,000
Mixed with Cat. 190	28,000
Mixed with Cat. 30	17,000
Mixed with Cat. 150	1,500
Specific Gravity, 25°C	1.6
Hardness, Shore D	90
Color	Black
Tensile Strength, psi	9,850
Linear Shrinkage, in/in	0.002
Operating Temp. Range, °C	60 to 200
Dielectric Strength, V/mil Dielectric Constant at 60 Hz	485
Volume Resistivity, ohm-cm, 25°C	5.6
Dissipation Factor, 60 Hz	1.5 x 10 <sup>-5</sup>
Thermal Conductivity, W/m- °K	0.015
Compressive Strength, psi	2.16
Coefficient of Expansion, in/in °F	15,000
Heat Distortion, °C Outgassing	1.4 x 10 <sup>-5</sup>
(with Cat. 190)	155
%TML	0.5
%CVCM	0.01

#### INSTRUCTIONS FOR USE:

- A. With Catalyst 190 listed with UL 94 V-0 (room temperature curing):
  1. By weight, thoroughly mix 5 parts Catalyst 190 to 100 parts BT-402-H resin.
  2. Degas and pour. Cure at room temperature for 12-24 hours at 25°C ambient.
- B. With Catalyst 30 listed with UL 94 V-0 and RTI Rating of 130°C (Heat curing - Recommended for higher operating temperature and physical property applications):
  1. By weight, thoroughly mix 10 parts Catalyst 30 to 100 parts BT-402-H resin.
  2. Pour and cure according to one of the following recommended cure schedules:
    - a) 85°C (185°F) 3-4 hours
    - b) 100°C (212°F) 2-3 hours
 For optimum performance, an additional 2 hours @ 365°F (185°C) is recommended.
- C. With Catalyst 150 (room temperature/heat curing):
  1. By weight, thoroughly mix 17 parts Catalyst 150 to 100 parts BT-402-H resin.
  2. Degas and pour. Cure at room temperature for 24 hours or for 2-3 hours at 35-40°C.



#### BONDATHERM HINGE PACKS

### BT-403-H

**BT-403-H** is a two component, aluminum filled epoxy system. This system is used for making heat resistant tools, parts, or bonds that require the highest thermal conductivity and heat resistance. We have developed this extremely conductive epoxy by formulating it with a unique combination of fillers, particle sizes and dispersion techniques.

**BT-403-H** has good heat dissipation making this a popular choice for a variety of heat sink applications. Its viscosity is particularly suited for Fin bonding. **BT-403-H** passes NASA's outgassing requirements per ASTM E-595-07.

FEATURES
<ul style="list-style-type: none"> <li>• Excellent Thermal Conductivity</li> <li>• Superior Adhesion</li> <li>• Low Viscosity allows quick self leveling</li> </ul>

Typical Specifications	
Color	Grey
Viscosity, 25°C, Resin	130,000
Mixed	8,000
Specific Gravity, 25°C	1.81
Working time, 100 grams, 25°C	5 Hours
Durometer, Shore D	90
25°C	65
100°C	
Tensile Strength, psi, 25°C Aluminum to Aluminum 1" overlap	9,000
	2,500
Compressive Strength, PSI, 25°C Mix Ratio, by weight	18,500
Operating temperature, °C	100:10
Coefficient of Thermal Expansion, °C	-55 to 155
Thermal Conductivity, W/m- °K	28 x 10 <sup>-6</sup>
4.5	
Outgassing	
% TML	0.91
% CVCM	0.07

#### STORAGE, HANDLING, AND AVAILABILITY:

- BT-401-H Resin and hardener should be stored at 25°C in original tightly sealed containers. Expected shelf life is twelve months in original unopened containers.
- Filler settling is common with these products. Gently stir resin and hardener before using to make sure fillers are evenly dispersed.



# MIL EMBEDDED

---

- Front Panels* ..... 158
- Wedgelocks* ..... 159-160
- Wavelock™ Data Sheet* ..... 160
- Heat Frames* ..... 161
- ATR Boxes / Enclosures* ..... 161
- Complex RF Shield Enclosures* ..... 161

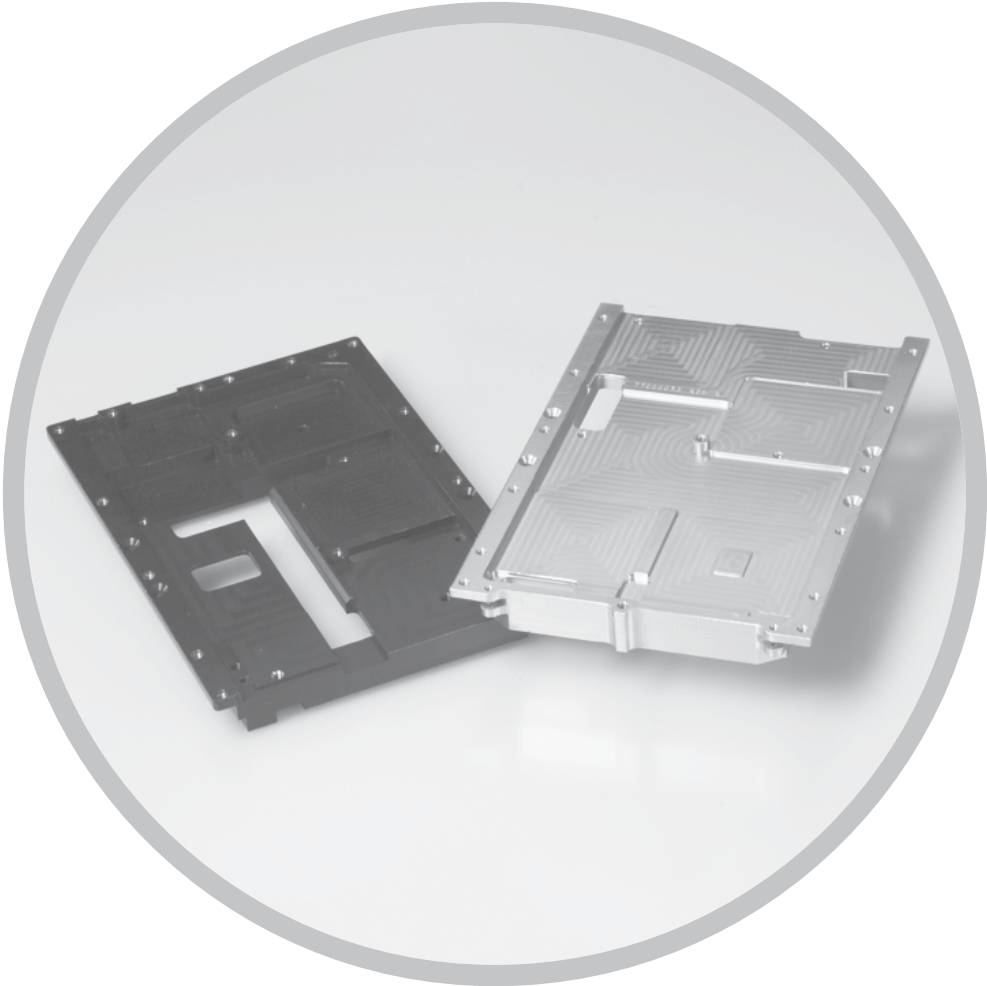

## FRONT PANELS

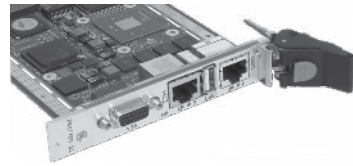

Standard & custom front panels that are silk-screened, fully assembled, and ready to mount.

Parts are made from extrusion and manufactured on high-speed CNC machines, providing a superior finish and precision fit to a specific application.

### FEATURES AND OPTIONS

- Panel cutouts
- Multi-color silk-screened
- Choice of EMC gaskets
- Choice of surface finish
- Optional hot swap microswitch installation
- Assembly and kitting

### APPLICATIONS

- VME Flat Panel
- Compact PCI
- 1101.10 compliant
- Electrical/Electronic instrumentation, controls, and devices.
- Electronic communication equipment.
- Computer system front and rear back panels.
- 19 inch panel plates - 1U, 2U and 3U make for many different applications.
- Audio devices, vacuum tube amplifiers, and signal processing equipment.



## FMC & PMC BEZEL KITS DATA SHEETS

**FMC & PMC Mezzanine Cards** describes a specification of I/O mezzanine modules in conjunction with FPGA or another device with configurable I/O capability. The design allows use on any industry standard slot card with form factors such as VME, VPX, CompactPCI, AdvancedTCA, MicroTCA, PCI, PXI, and many others.. Wakefield-Vette can customize your specific application needs for custom FMC & PMC Bezels.

### FEATURES

- Material: Aluminum
- Kit: Bezel, Elastomer Gasket, Two M2.5 x 6mm PH Stainless Steel Screws
- Custom cutouts, silkscreen or overlays available

WV Part Number	Description	Kit Description	Size
PMC-BEZEL-KIT-01	Aluminum PMC Bezel Kit (1050056-00)	PMC Bezel, Elastomer Gasket, Qty. Two M2.5 x 6mm Screws	0.659" L x 0.500" W x 2.913" H (16.75mm x 12.70mm x 74.00mm)
FMC-BEZEL-KIT-01	Aluminum FMC Bezel Kit (1050117-00)	FMC Bezel, Elastomer Gasket, Qty. Two M2.5 x 6mm Screws	0.659" L x 0.500" W x 2.404" H (16.75mm x 12.70mm x 61.00mm)
PMC-GASKET-01	PMC EMC GASKET O RING (1070010-00)	Spare, Replacement Component	
FMC-GASKET-01	FMC EMC GASKET O RING (1070036-00)	Spare, Replacement Component	



### PMC-BEZEL-KIT-01

KIT WITH PMC GASKET & MOUNTING HARDWARE

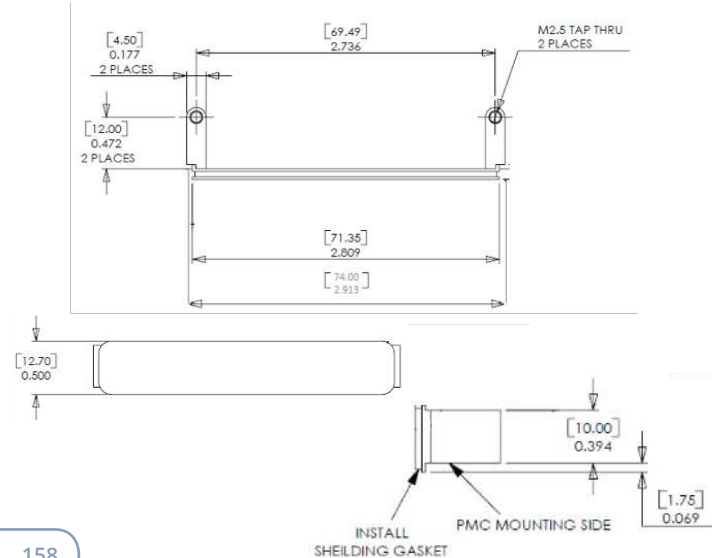

### FMC-BEZEL-KIT-01

KIT WITH FMC GASKET & MOUNTING HARDWARE

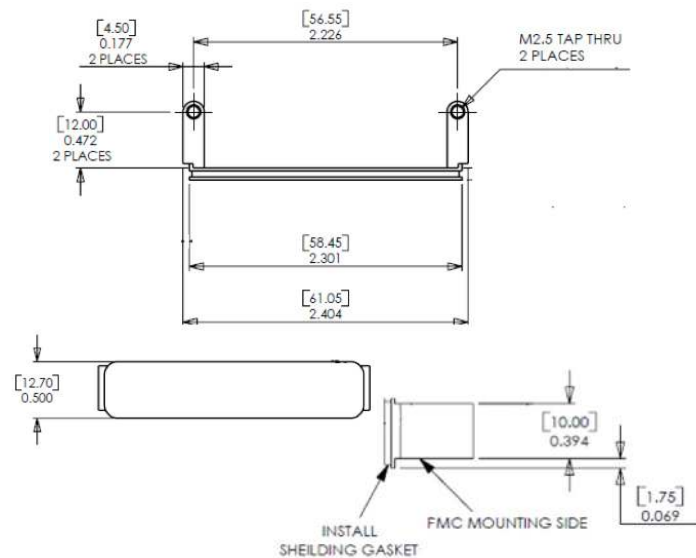

## WEDGELOCKS



Rugged fastener or retainer used to clamp a PCB within a cold wall slot.

- Provides clamping force to resist shock and vibration in rugged environments
- Provides a thermally conductive path from the heat frame to the cold wall
- Flexible mounting options to meet customer requirements
- Available separately or integrated into Heat Frame
- Ability to cross competitors Part Numbers

Wedgelocks are available in various profiles and allow for configurable length, mounting and plating selections. For configurations not shown within the data sheets, please contact the factory to review.

### "B" STYLE WEDGELOCK

"B" Style	# of Wedges	Assembly with Long Screw			DSCC CID
		Height	Width	Length (min)	
418B	3	0.180	0.240	2.80+	59590 /11, /12
422B	3	0.220	0.220	2.80+	59590 /7, /8, /9, /10
426B	3	0.260	0.225	2.80+	59590 /3, /4, /5, /6

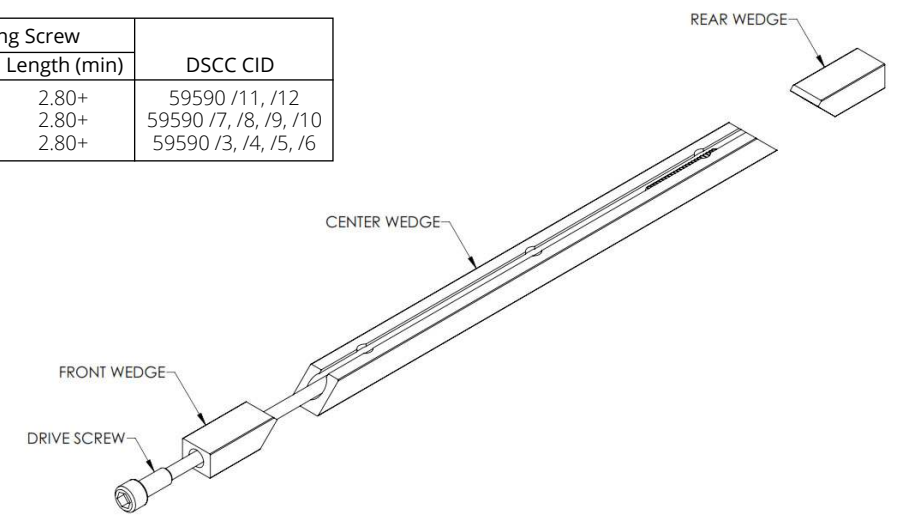

### "C" STYLE WEDGELOCK

"C" Style	# of Wedges	Assembly with Mounting Bar			DSCC CID
		Height	Width	Length (min)	
419C	5	0.192	0.25	2.80+	59789 /9, /10
422C	5	0.225	0.225	2.80+	
422C7	7	0.225	0.225	4.80+	
426C	5	0.260	0.250	2.80+	Pending
426C7	7	0.260	0.250	4.80+	
438C	5	0.375	0.365	2.80+	59789 /15,

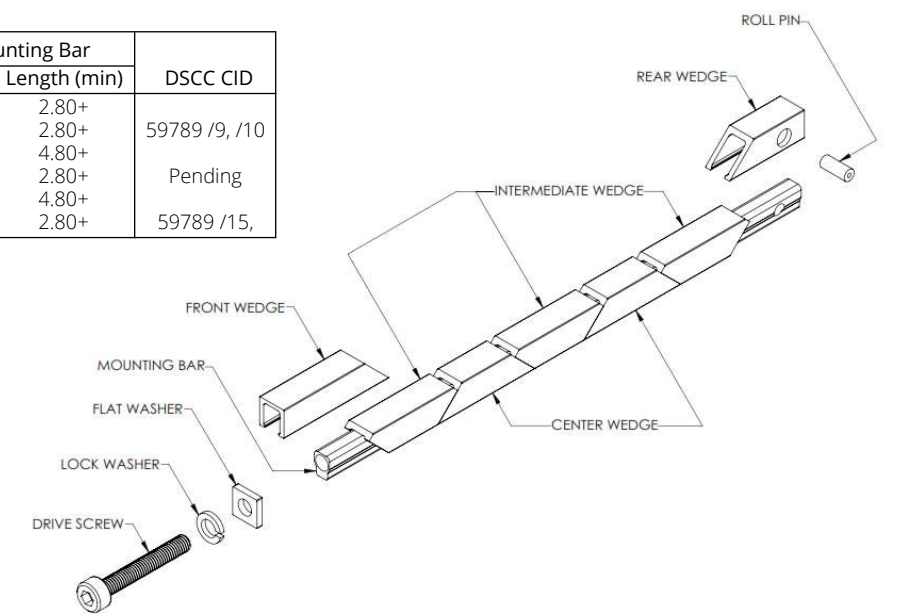

\* All dimension provided in Inches  
 \*\* Standard profiles and lengths listed, inquire for other sizes

## WEDGELOCKS

### "D" STYLE WEDGELOCK

"D" Style	# of Wedges	Assembly with Long Screw			DSCC CID
		Height	Width	Length (min)	
422D	5	0.220	0.220	4.80+	Pending
426D	5	0.260	0.225	4.80+	Pending

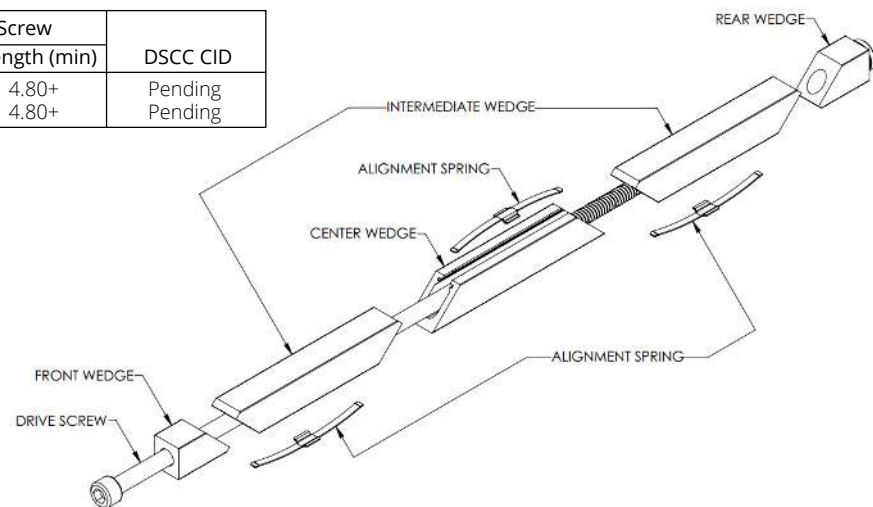

\* All dimension provided in Inches  
 \*\* Standard profiles and lengths listed, inquire for other sizes

### WAVELOCK™ DATA SHEET

**Wavelock™** is a patent-pending, low-cost, high-performing, form fit, and function alternative to wedgelocks for some applications. A Wavelock assembly consists of only two discrete parts and represents the simplest form of a card retainer within a wedgelock envelope. The discrete parts are a wave spring and an injection molded carrier. Additional benefits include easy tool-free installation and visual indication of correct installation.

#### FEATURES AND BENEFITS

- Low cost for light shock and vibration applications.
- Light weight assembly with uniform clamping force.
- Narrow width for maximum PCB component area.
- Low profile design allows for decreased slot pitch.
- Special lengths, finish, and other design options available.

#### MATERIAL

- Carrier: Polysulfone (PSU)
- Wave Spring: 17-7 PH Stainless Condition C to CH900



#### ENGAGED STATE

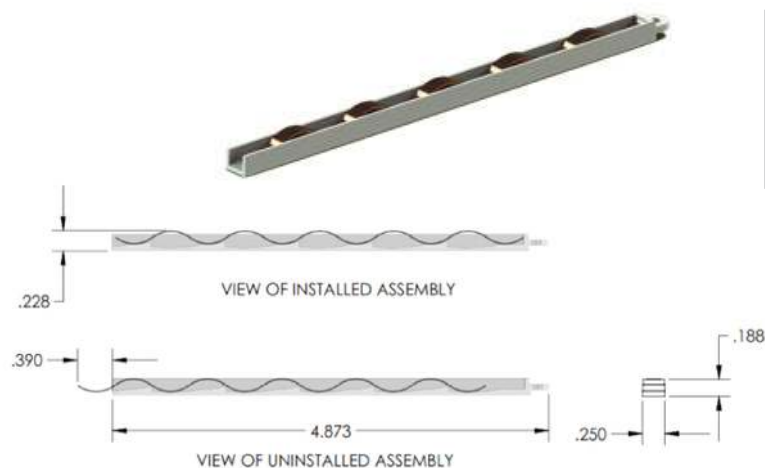

#### RELAXED STATE

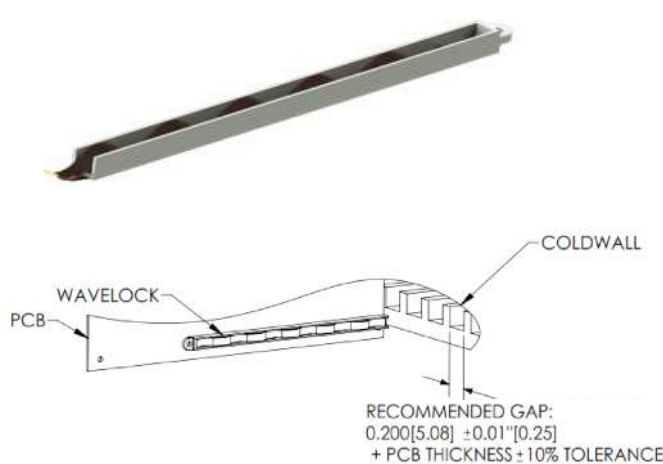

## HEAT FRAMES

Milled aluminum heat frames are used with electronics design to meet or exceed rugged specification requirements.

Heat frames are CNC precision-machined out of solid aluminum (or copper) and precisely match the topography or skyline of an electronic printed circuit board being ruggedized.

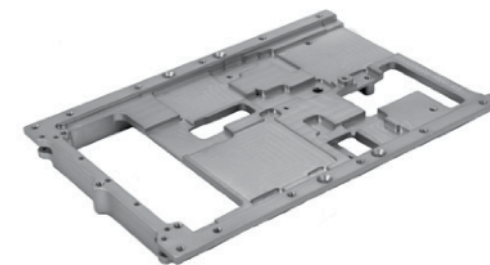

#### FEATURES AND OPTIONS

- Plating options include Chromate, Black Anodize, and Electroless Nickel.
- Integrated Heatpipes when needed
- When combined with thermal-interface material or "gap pads," conduction-cooled heat frames increase a board's operating temperature range, as well as its resistance to shock and vibration.
- Designs can integrate Front or Rear I/O and can also include Top and Bottom Covers for compliance with Two-Level Maintenance.
- When integrated with wedgelocks and ejectors, this product allows VME, cPCI and other boards to fit within conduction cooled chassis slot dimensions with zero insertion force.

#### APPLICATIONS

- IEEE 1101.2
- VITA 30.1
- VITA 48 (both 0.8" and 1.0" slot pitch)
- Mezzanine cards
- Ruggedized Enviroments

## ATR BOXES / ENCLOSURES

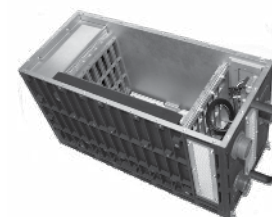

Typically the rugged housings for multiple VME, CompactPCI or VPX computers boards. Enclosures can be bolted, brazed or epoxied together.

- Standard configuration COTS and Custom ATR enclosures
- Power supply and Backplane available when required
- Brazed or Epoxied and bolted Solutions
- Complete Custom Design capabilities to meet specific customer constraints
- Finishes Anodize :
- Chem Film
- Dual Plating
- Painting

## COMPLEX RF SHIELD ENCLOSURES

Complex machined parts can be executed through Wakefield-Vette's North Carolina facility. One major product line it supports intricate machined parts for the RF industry.

RF shielded enclosures refers to any box, chassis, or other packaging that prevents the passing of electromagnetic interference or radio frequency.

#### APPLICATIONS

- Desktop Shielded Enclosure
- Software-defined Radios
- Rugged/Embedded Computing
- TEMPEST/Secure Computing
- Sensor Equipment
- Surveillance Equipment
- Tactical Devices
- EMI Shielded Enclosure for Communications Equipment

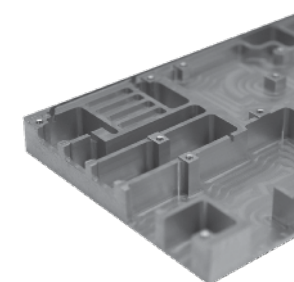



# ELECTRONICS PACKAGING SYSTEMS

<i>Electronic Packaging Systems</i> .....	164-165
<i>System Level Packaging</i> .....	166-167

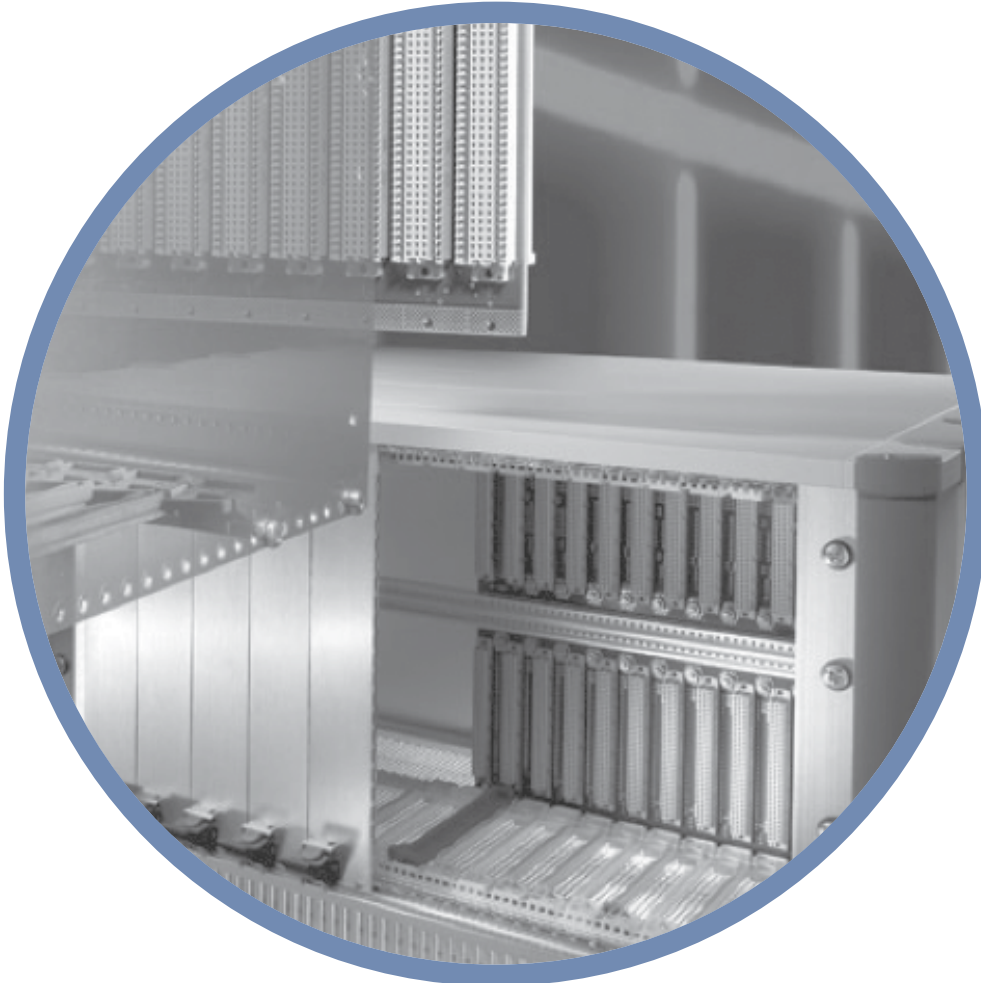

*Wakefield-Vette manufactures both custom and standard electronic packaging solutions. In June of 2015, Wakefield-Vette announced an exclusive strategic partnership with Heitec AG, a recognized leader in electronic packaging systems (EPS), to sell, customize, and service the Heitec product line (formerly Rittal) to the North American marketplace.*

*Wakefield-Vette has the ability to modify a customer's unique specification within a quick turnaround time which separates it broad product line from the rest in North America.*

*Wakefield-Vette has achieved a leading position in the Rugged COTS packaging marketplace, providing for VME/VME64x, VXS/VPX, VXI,PXI, AdvancedTCA, and MicroTCA, and CompactPCI/2.16 architectures.*

## ELECTRONIC PACKAGING SYSTEMS

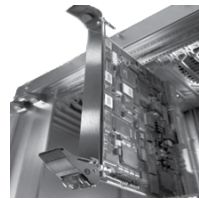

### FRONT PANELS & EJECTOR HANDLES

Wakefield-Vette manufactures custom front panels that are silk-screened, fully assembled, and ready to mount to your PCB. Parts are made from extrusion and manufactured on high-speed CNC machines to mill your custom cut outs and features, providing a superior finish and precision fit to your board. We also have the ability to stamp front panel cutouts to meet your specifications or high volume requirements.

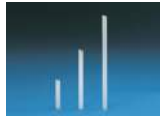

#### STANDARD FRONT PANELS

Subrack system for direct mounting in a cabinet. Mounting either on top hat rails or on mounting plate. Suitable for installation of standardized PCBs or plug-in units.



#### INJECTORS & EJECTORS

We offer all VME and compactPCI related front panel accessories, including gaskets and handles to meet Vita 41, 46, 48, 57, and IEEE 1101.10 requirements.



#### CUSTOM FRONT PANELS

In addition to a variety of standard finishes and options, Wakefield-Vette offers custom front panel production along with our in-house silk-screening process. We offer build to order ATCA and PCI panels, as well as customized AMC, PMC, and FMC bezels.



#### MEZZANINE FRONT PANELS

Extruded aluminum and Zinc Die Cast for PCI mezzanine cards and conforms to IEEE 1386.

## ELECTRONIC PACKAGING SYSTEMS COMPONENTS



Besides complete subrack and system solutions Wakefield-Vette offers a wide range of individual components and accessories for setup, mounting and upgrade. Our inside and outside sales staff will gladly help you to find the right selection of components and support you in compiling the optimum package to fulfill your individual preferences and requirements.



#### CARD GUIDES

Keyable Guide rails to IEEE 1101.10. Prepared to accommodate a ground contact for assembly of a plug-type connection. Available in different form factors and material including plastic.



#### COVERS

Covers are slid into the front and rear horizontal rails for mounting backplanes/connectors. There are several styles of this product line.



#### HORIZONTAL RAILS

The adaptor rails accommodate the guide rails when fastened to the center horizontal rail. Front and rear horizontal rails available to meet the very simple to the very complex subrack configurations including rails to meet the IEEE 11001.10/1101.11 specifications.



#### BACKPLANES

Wakefield-Vette offers various backplanes. Our engineering team can help assist in any backplane design with your PICMG, VITA-based, VME, VME 64X, cPCI, uTCA, or custom architecture design.

## SUBRACKS

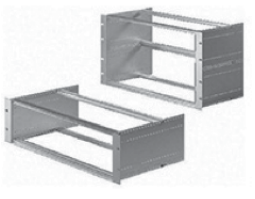

The modular concept of Ripac subracks facilitates a wide range of application options with a minimum of components. All Ripac subracks are based on the same horizontal rails and system components. The difference lies in the design of the side panels and installation options. The subracks are shock and vibration-tested and comply with IEC 60 297-3-101, -102, -103.



#### RIPAC COMPACT

Subrack system for direct mounting in a cabinet. Mounting either on Din rails or on mounting plate. Suitable for installation of standardized PCBs or plug-in units.



#### RIPAC ECO

Subrack system for standard applications. Suitable for installation of standardized PCBs or plug-in units of 160 and 220 mm depth.



#### RIPAC VARIO EMC

Subrack system for EMC applications or complex installations. Suitable for installation of standardized PCBs or plug-in units up to 400 mm depth.



#### RIPAC EASY

Subrack system for standard applications or high mechanical loads. In cases that require easy handling and fast assembly.



#### RIPAC VARIO

Subrack system for standard applications or complex installations. Suitable for installation of standardized PCBs or plug-in units up to 400 mm depth.

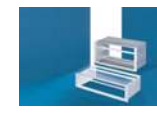

#### RIPAC VARIO MOBILE

Subrack system for applications in rail vehicles. Suitable for installation of standardized PCBs or plug-in units.



## ELECTRONIC CASES

The RiCase instrument case impresses with its modern design and high functionality. Particular features include the numerous color variants and the all-metal enclosure construction. The Ripac Vario-Module system enclosure (desktop or rack-mount enclosure) is fully compatible with the latest Ripac subrack range, making it ideal for individual configuration and assembly as a microcomputer system. At just 1 U, the HeiBox system enclosure offers a high packaging density in the smallest space.



#### HEIBOX ECO

Cost optimized 1 U system housing for use as rack-mount enclosure or instrument case.



#### RICASE

Instrument case for installation of 19" slide-in assemblies and elements. For mobile and stationary applications.

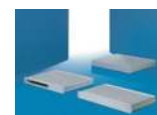

#### RIBOX

Optionally for use as an instrument case or rack-mount enclosure. Accommodates Eurocards/Double Eurocards (horizontal), bridges, hubs, routers or modems.



#### RIPAC VARIO MODULE

Optionally for use as an instrument case or rack-mount enclosure. External dimensions according to IEC 60 297-1 for installation in enclosures.

## SYSTEM LEVEL PACKAGING



### CPCI / CPCI SERIAL

Wakefield-Vette offers a wide selection of CompactPCI systems that conform to IEC 60 297-3 and IEEE 1101.1/10/11, as well as PICMG 2.0. Systems include backplane and power supply, excellent cooling, fully assembled, pre-wired and tested.



### RACK MOUNT SYSTEMS

Configuration of 19" industrial computer systems according to CompactPCI specification for Telecommunication and Industrial Automation.



### CPCI SERIAL PLATFORM SYSTEMS

Configuration of 19" industrial computer systems according to CompactPCI Serial specification.

### MicroTCA



MicroTCA offers standardized modularity, compact design and high scalability and bandwidth. Additionally, the consistent platform strategy reduces the time to market. Whenever ultra fast data transmission or data storage is required, MicroTCA systems are the first choice. This is true not only for telecom applications but also for industrial control systems or medical engineering.



### CubeTCA

Based on the MTCA specification the compact CubeTCA offers a wide range of application fields in the industrial sector. The CubeTCA can either be assembled directly on the mounting plate or integrated within the target system.



### AIR MANAGEMENT PANELS

Filler sheets are mounted on the AMC face plates and are used to route the airflow in ATCA carriers and MicroTCA systems.



### MicroTCA DEVELOPMENT SYSTEM

Instrument MicroTCA development systems are suited for design of hard and software or for testing AMC modules.



### FACE PLATES

These face plates are used for AMC cards and ATCA carriers, or as filler panels in MicroTCA systems.



### MicroTCA RACK MOUNT SYSTEMS

MicroTCA specification is designed as an amendment to the ATCA standard as a lower-cost compact version for the low-end sector. The main features are a compact design, high scalability, modularity and considerably reduced system costs.



### PicoTCA

Based on the MTCA specification, PicoTCA is a modular ready-to-run system, which carries up to 12 AMCs and 1 MCH. Due to the robust construction, the 19" rack can be used both in the telecommunication and in the industrial sector.

### VME



Wakefield-Vette supplies complete plug & play solutions for VME applications. Systems are based on standard components which may be configured to your specification. VME systems are complete with power supply, backplane, measures for EMC and ESD protection, climate control, fully assembled, pre-wired, and tested.



### BACKPLANES

The VME64 is a new addition to the VME family to ANSI/VITA 1-1994 and supports 64-bit data traffic. The VME64x extends the VME family to ANSI/VITA 1.1-1997 and is available with the optional 133-pole 2 mm connector J0. 160-pole connectors are used with VME64x.



### MPS MONITORING

The monitoring electronics for microcomputer packaging systems (MPS) offers a highly flexible, scalable security concept for key parameters such as temperature, voltage and fan speed.



### RACK MOUNT SYSTEMS

Ripac systems available in many different variations. Prepared to accommodate VMEbus boards and drives while having MPS Monitoring feature.



### SLIM BOX VARIO

Configuration of 19" industrial computer systems according to VME specification.





# THERMAL EXTRUSION PROFILES

<i>Flatback Extrusions</i> .....	172-234
<i>L-style Extrusions</i> .....	235-239
<i>Center Channel Extrusions</i> .....	239-245
<i>Multi Channel Extrusions</i> .....	245-247
<i>Flatback with Integral Mounting Feet</i> .....	248-252
<i>T-style Extrusions</i> .....	252-256
<i>H-style Extrusions</i> .....	256-262
<i>Double-Side Extrusions</i> .....	262-263
<i>Mounting Shelf Extrusions</i> .....	263-265
<i>Press Pack Extrusions</i> .....	265-268
<i>Power Module Extrusions</i> .....	268-269
<i>Forced Convection Extrusions</i> .....	269-271
<i>Modular Extrusions / Enclosures</i> .....	271-272
<i>Hollow Extrusions</i> .....	272-273
<i>Miscellaneous Extrusions</i> .....	273-276



*Extruded heat sinks are the most common heat sink used for thermal management today. They are manufactured by pushing hot aluminum billets through a steel die to produce the final shape. The most common aluminum alloy is 6063-T5, but other 6XXX alloys can also be examined as needed. When the material is extruded, the initial sticks are 30-40 feet and length and are very soft. The material is stretched by grabbing both ends to produce a straight stick. After stretching, the material can be either air or over aged depending upon the required final hardness of the material. After the aging process, the material is cut to the final length and any final fabrication (holes, pockets, or other secondary machining) can be done. Extruded heat sinks are usually supplied with a "finish" such as anodizing which can enhance its thermal performance. The heat sinks can also be supplied with a chromate finish which provides some corrosion protection or can be used as a primer before a final paint or powder coating is applied.*

*While each extruded shape is unique to the requirements that it was designed for, extruded heat sinks are the most cost-effective cooling solution. Each shape is engineered to achieve the optimal thermal and structural performance. Wakefield-Vette partners with a large list of vendors which insures that you have the best thermal solution based on your system structure and thermal requirements.*

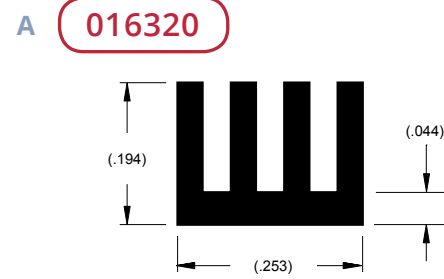

Per.	1.79	in.
WT.	0.04	lb/ft
θsa	42.00	°C/w/3"

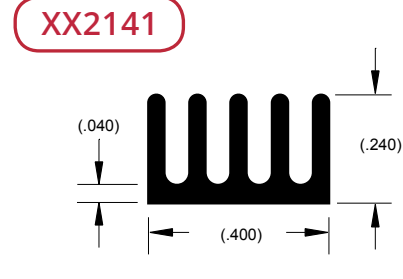

Per.	2.71	in.
WT.	0.06	lb/ft
θsa	20.30	°C/w/3"

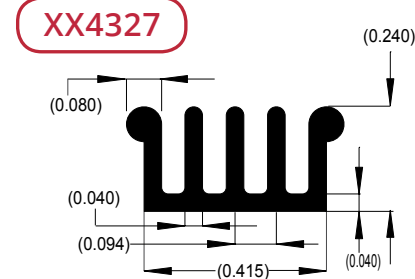

Per.	2.83	in.
WT.	0.07	lb/ft
θsa	26.00	°C/w/3"

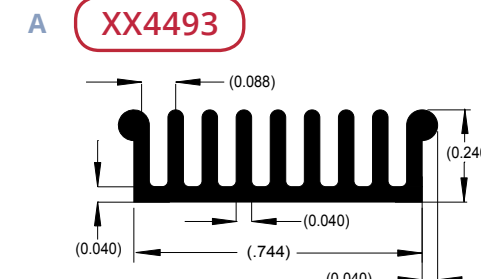

Per.	5.01	in.
WT.	0.13	lb/ft
θsa	18.00	°C/w/3"

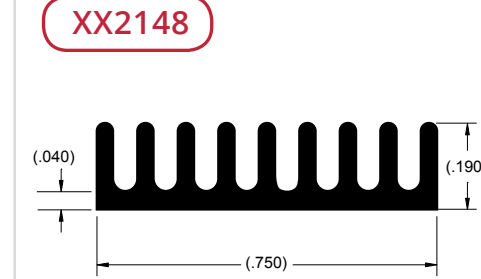

Per.	3.96	in.
WT.	0.09	lb/ft
θsa	7.00	°C/w/3"

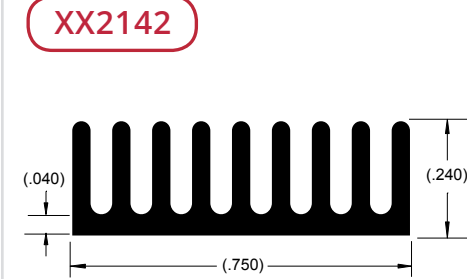

Per.	4.86	in.
WT.	0.11	lb/ft
θsa	8.20	°C/w/3"

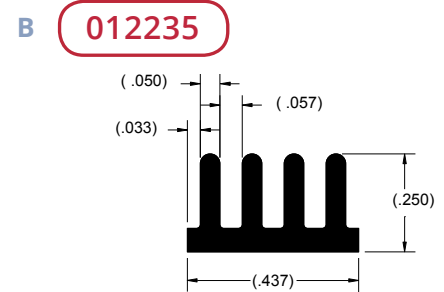

Per.	2.39	in.
WT.	0.07	lb/ft
θsa	29.16	°C/w/3"

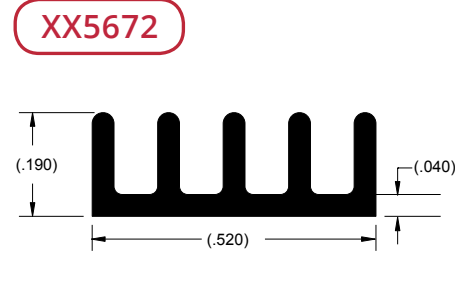

Per.	2.48	in.
WT.	0.06	lb/ft
θsa	28.50	°C/w/3"

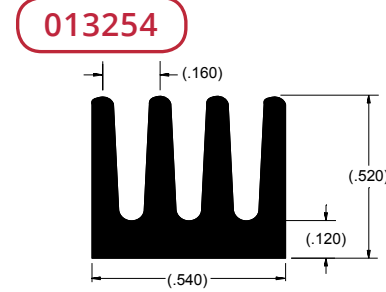

Per.	4.24	in.
WT.	0.21	lb/ft
θsa	14.00	°C/w/3"

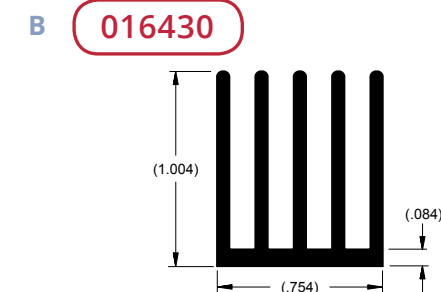

Per.	10.76	in.
WT.	0.37	lb/ft
θsa	7.90	°C/w/3"

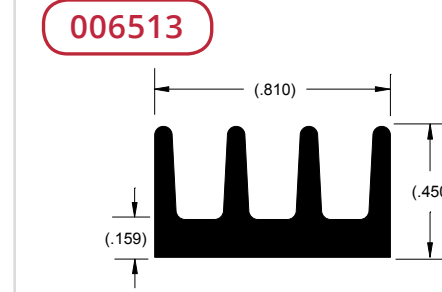

Per.	4.63	in.
WT.	0.24	lb/ft
θsa	15.10	°C/w/3"

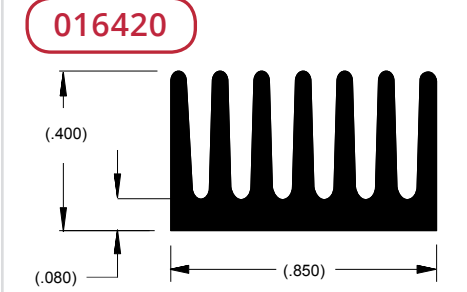

Per.	5.91	in.
WT.	0.24	lb/ft
θsa	12.50	°C/w/3"

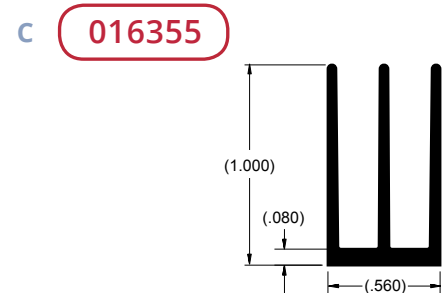

Per.	6.69	in.
WT.	0.20	lb/ft
θsa	9.50	°C/w/3"

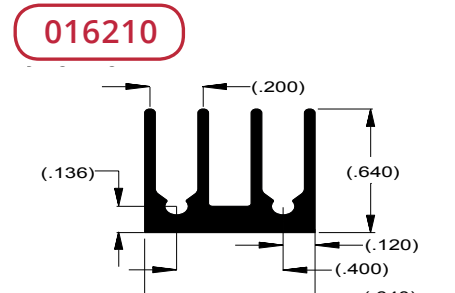

Per.	5.53	in.
WT.	0.20	lb/ft
θsa	11.10	°C/w/3"

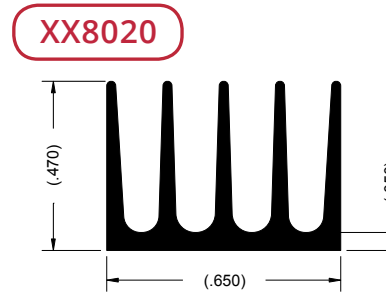

Per.	5.25	in.
WT.	0.14	lb/ft
θsa	12.00	°C/w/3"

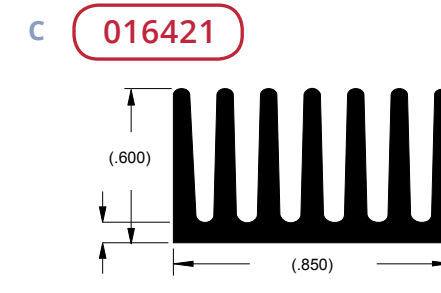

Per.	8.71	in.
WT.	0.34	lb/ft
θsa	9.70	°C/w/3"

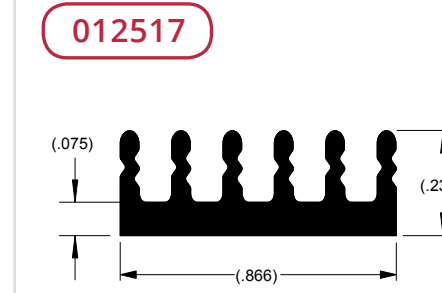

Per.	3.79	in.
WT.	0.13	lb/ft
θsa	17.10	°C/w/3"

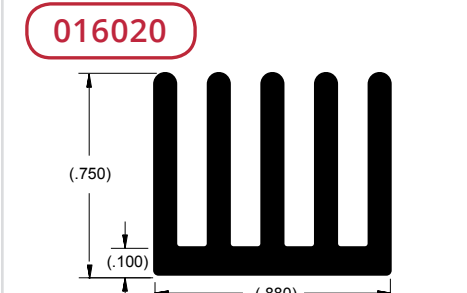

Per.	8.90	in.
WT.	0.41	lb/ft
θsa	8.40	°C/w/3"

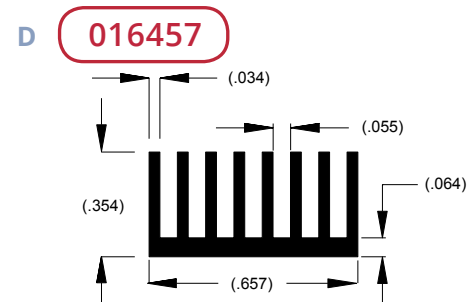

Per.	6.08	in.
WT.	0.15	lb/ft
θsa	15.80	°C/w/3"

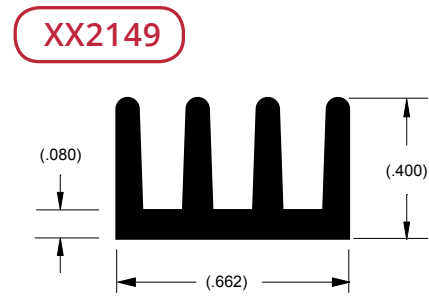

Per.	3.86	in.
WT.	0.14	lb/ft
θsa	8.80	°C/w/3"

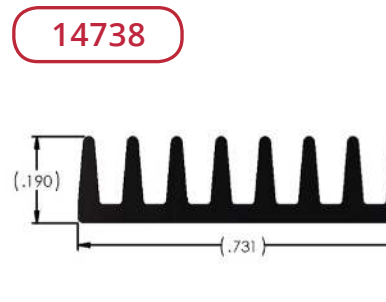

Per.	3.63	in.
WT.	0.08	lb/ft
θsa	19.29	°C/w/3"

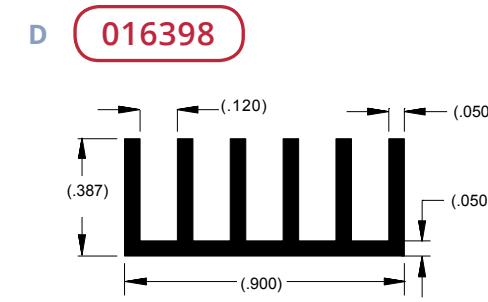

Per.	5.94	in.
WT.	0.18	lb/ft
θsa	12.30	°C/w/3"

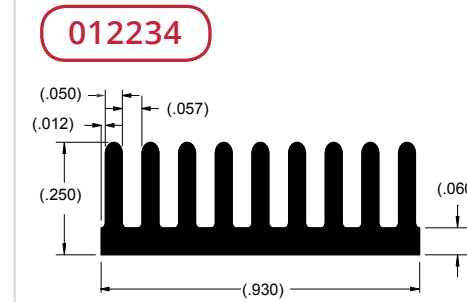

Per.	5.13	in.
WT.	0.16	lb/ft
θsa	13.64	°C/w/3"

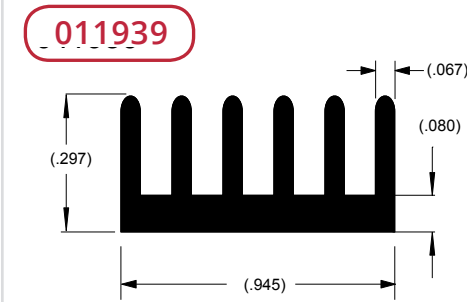

Per.	4.44	in.
WT.	0.19	lb/ft
θsa	15.60	°C/w/3"



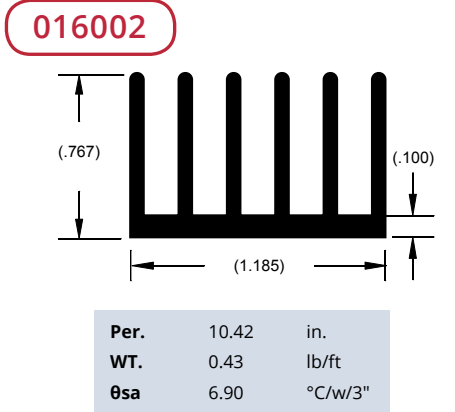
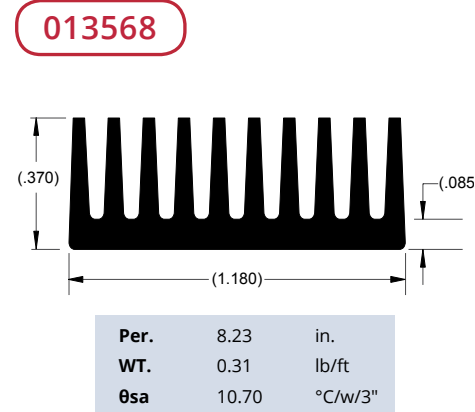
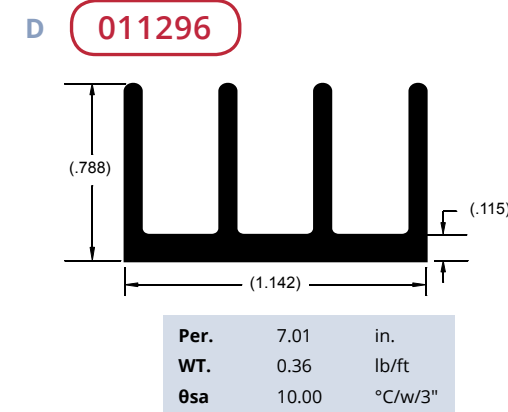
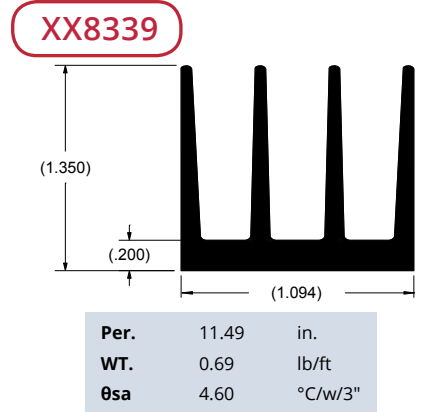
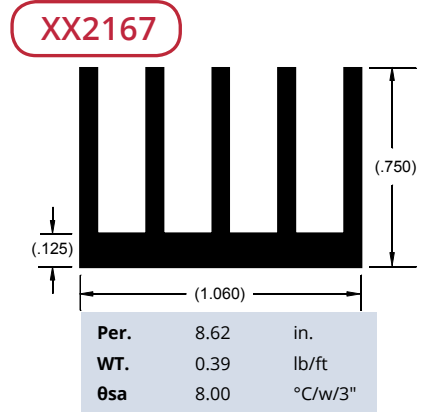
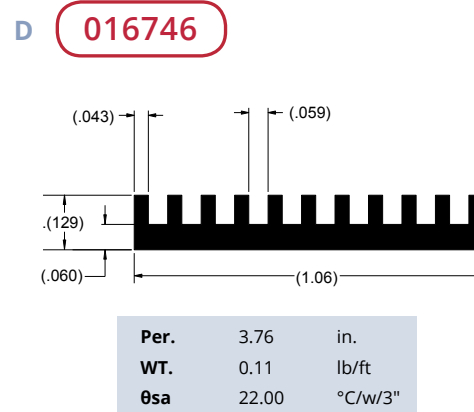
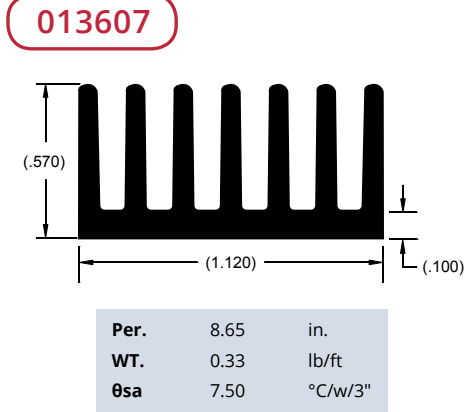
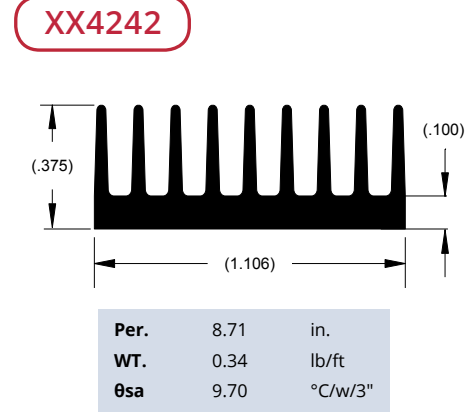
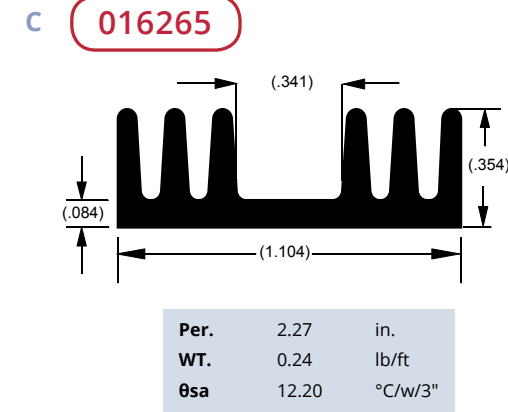
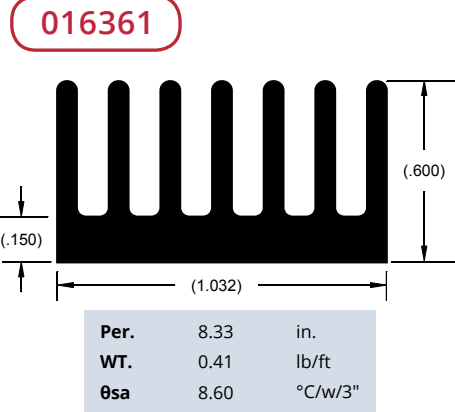
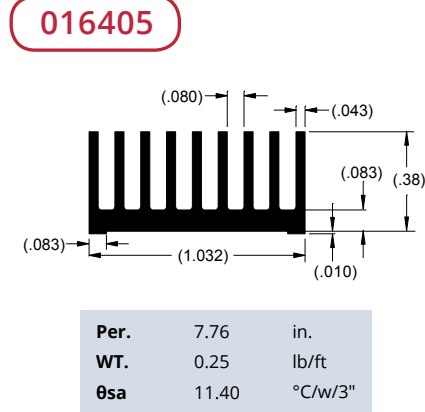
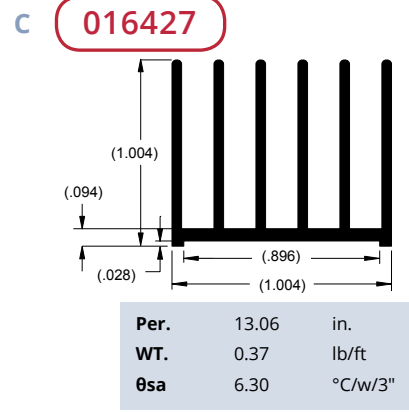
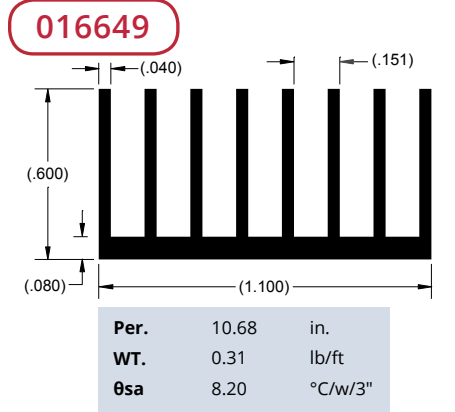
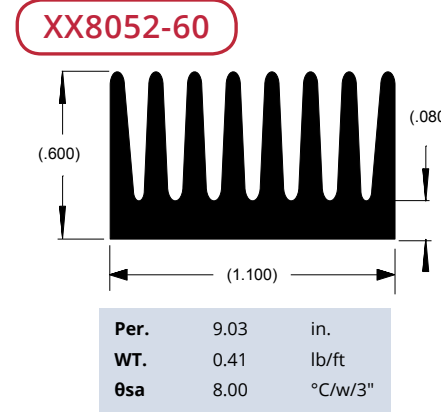
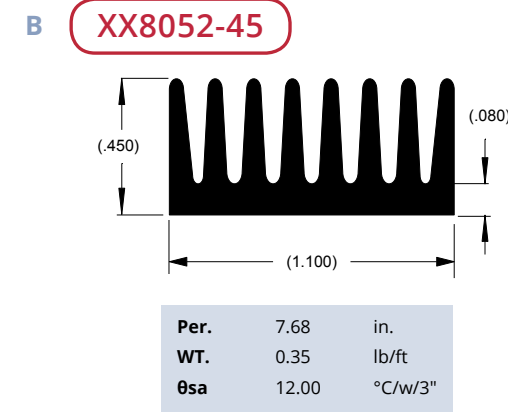
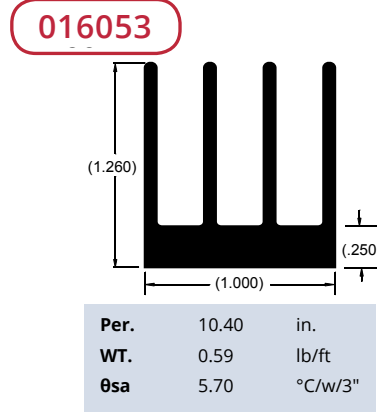
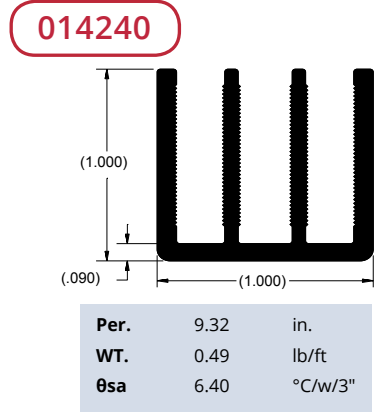
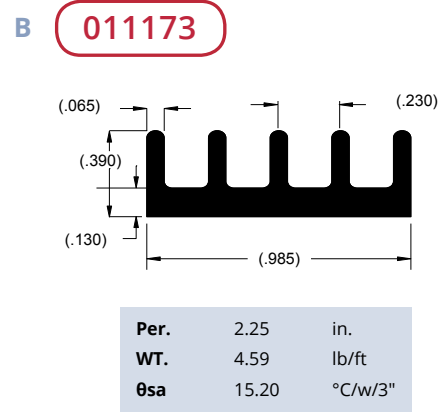
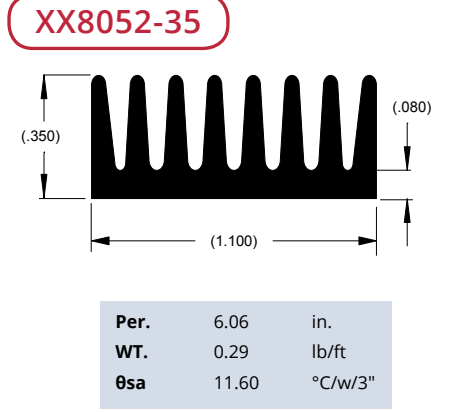
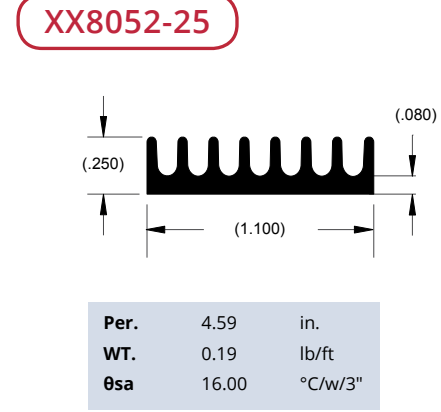
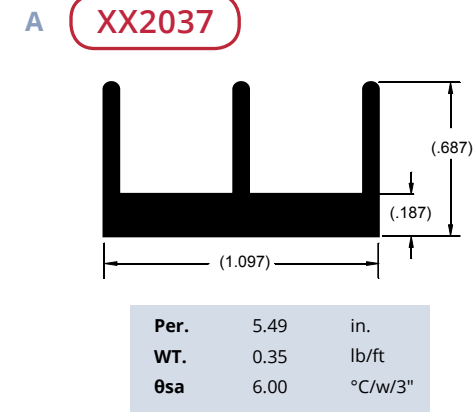
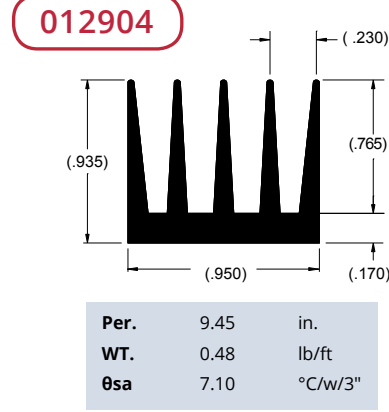
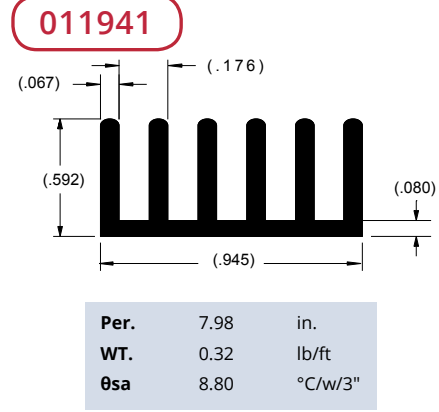
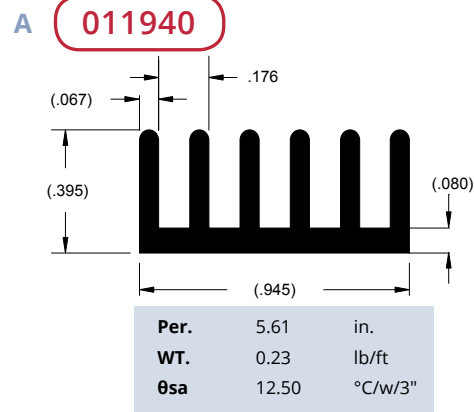

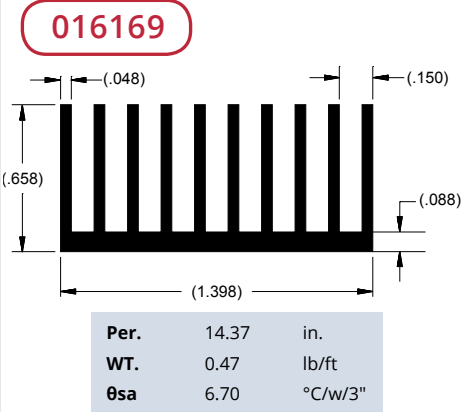
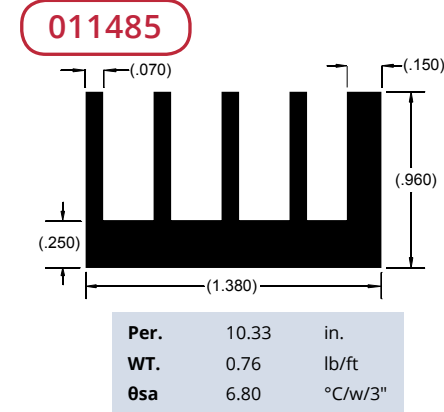
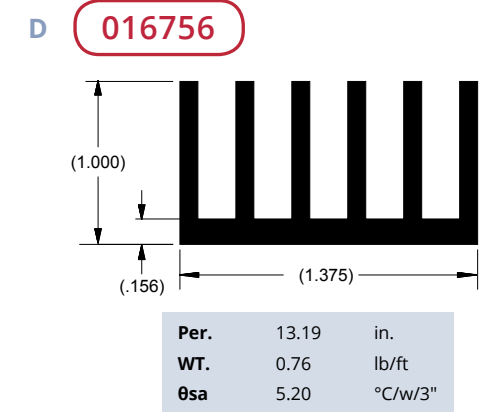
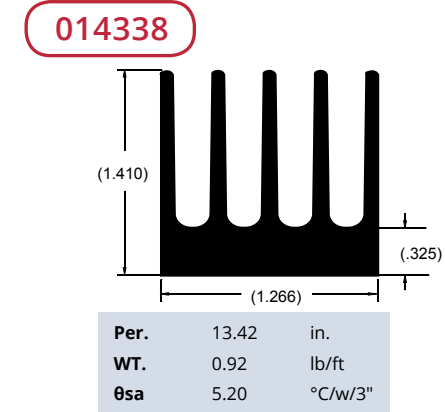
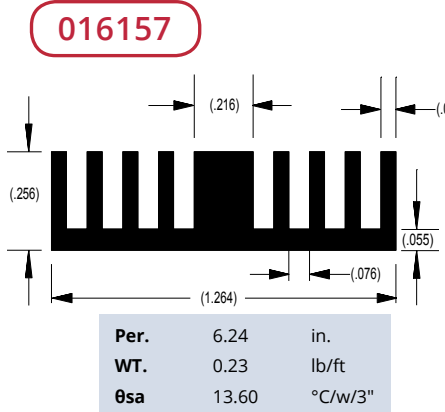
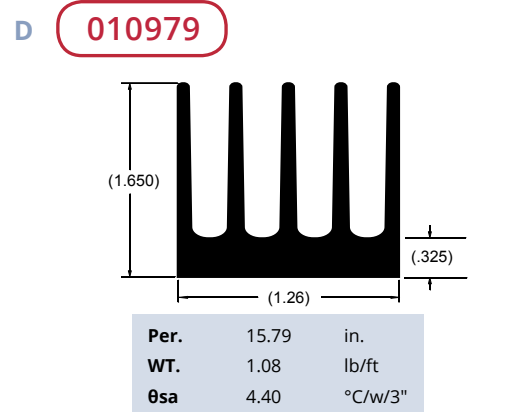
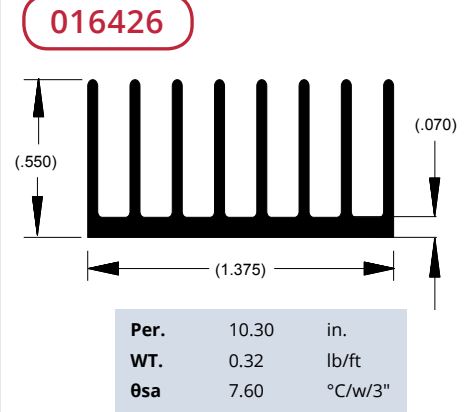
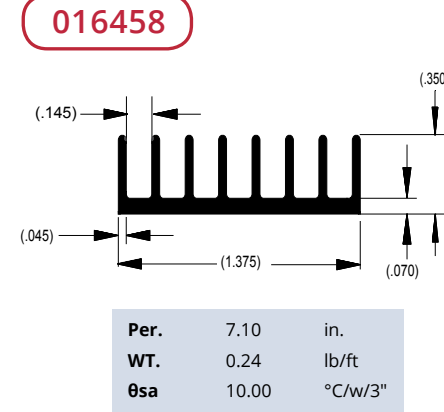
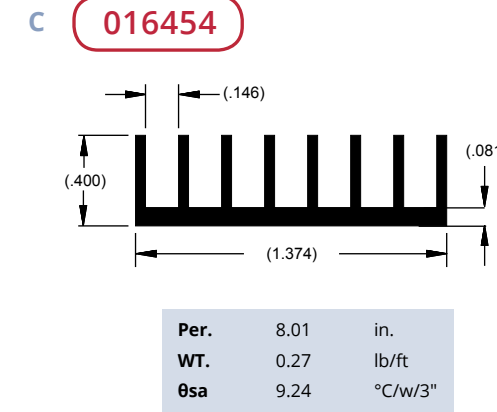
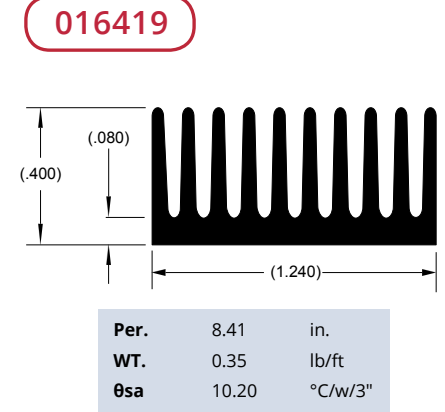
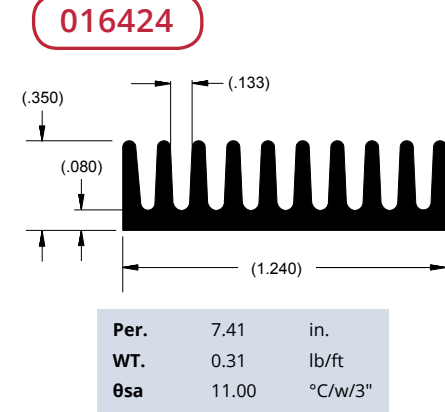
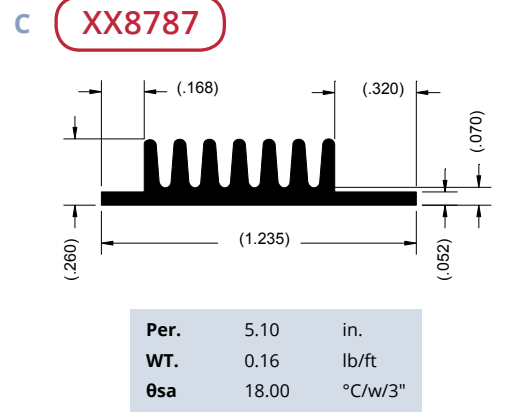
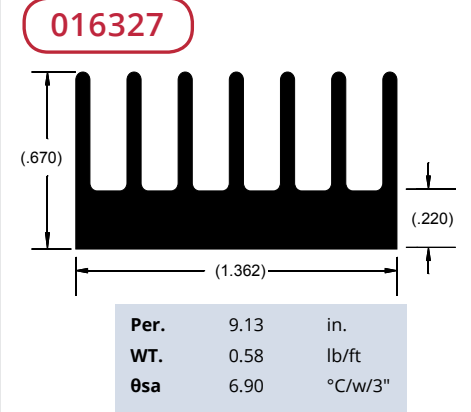
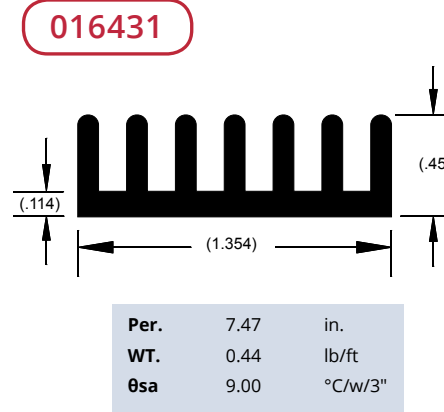
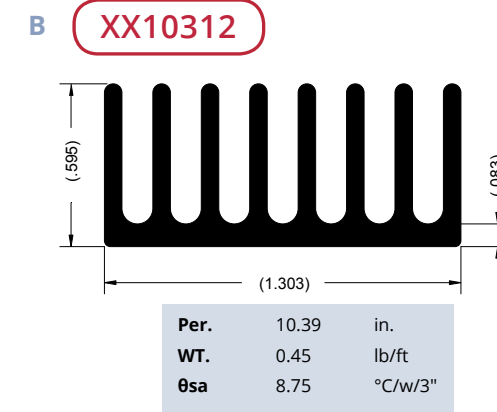
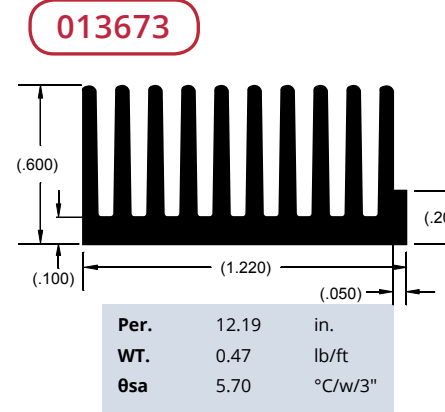
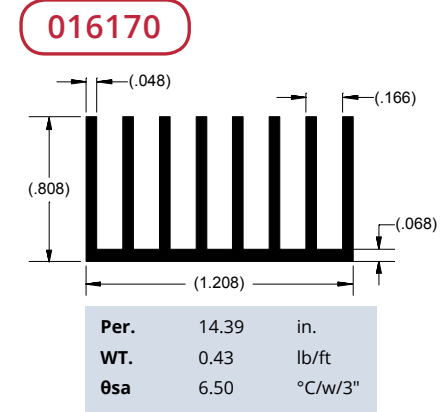
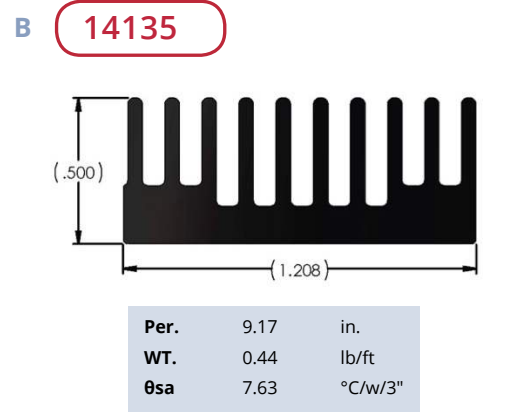
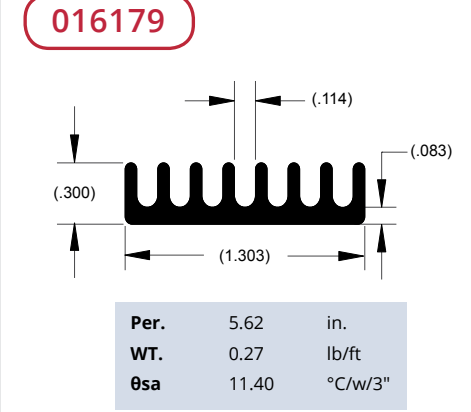
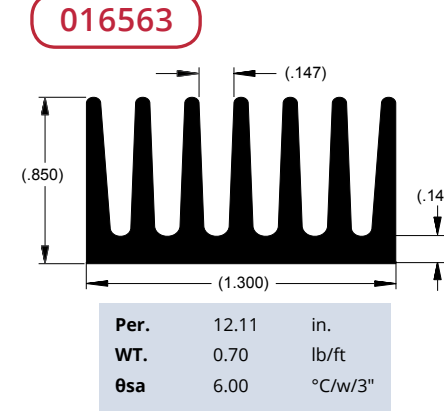
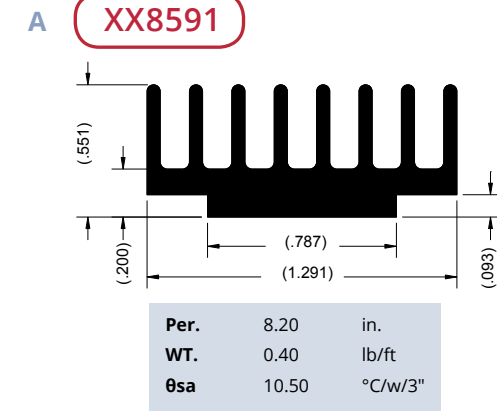
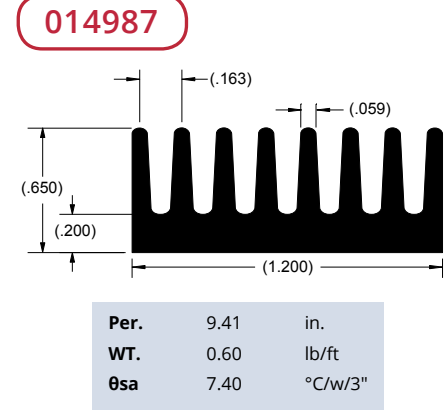
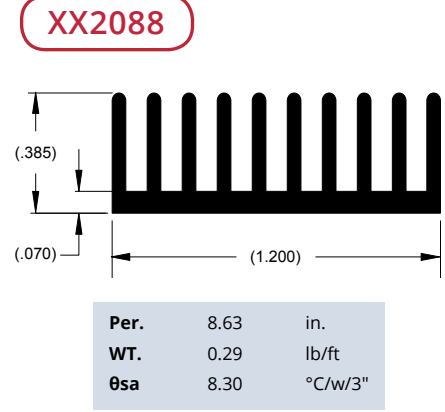
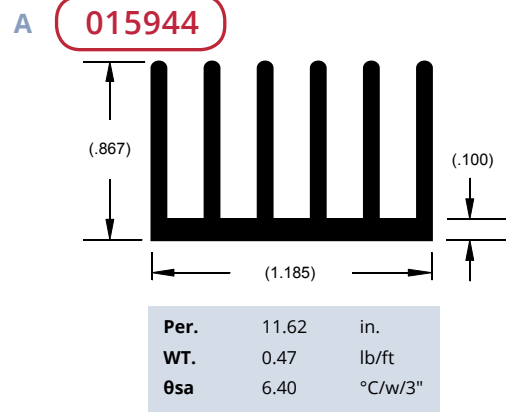

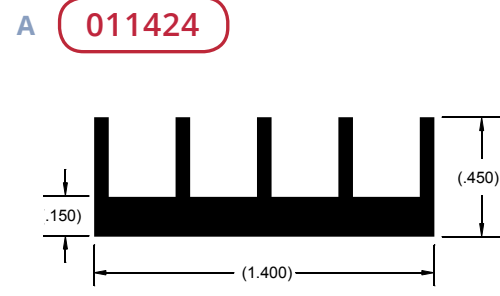

Per.	6.07	in.
WT.	0.35	lb/ft
θsa	11.50	°C/w/3"

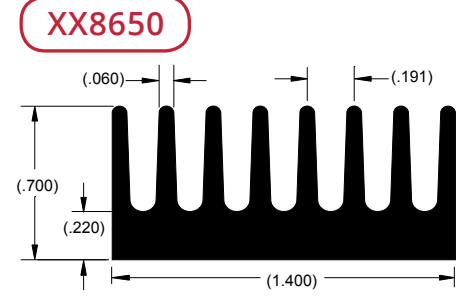

Per.	10.22	in.
WT.	0.70	lb/ft
θsa	8.80	°C/w/3"

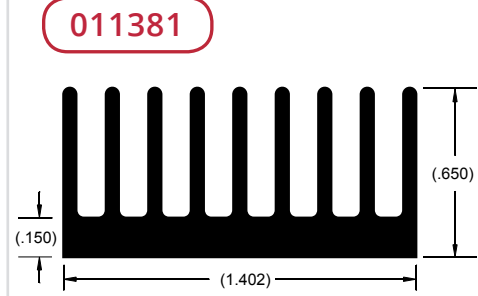

Per.	11.23	in.
WT.	0.52	lb/ft
θsa	6.20	°C/w/3"

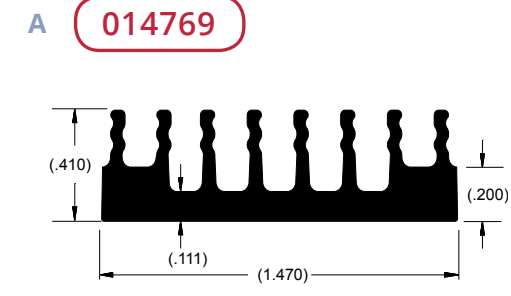

Per.	7.44	in.
WT.	0.39	lb/ft
θsa	8.80	°C/w/3"

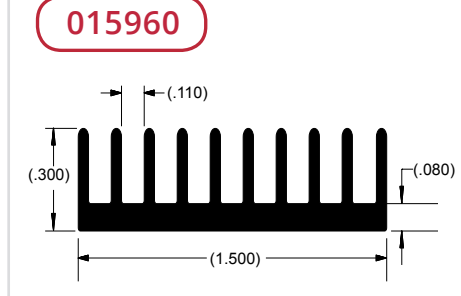

Per.	7.35	in.
WT.	0.27	lb/ft
θsa	10.50	°C/w/3"

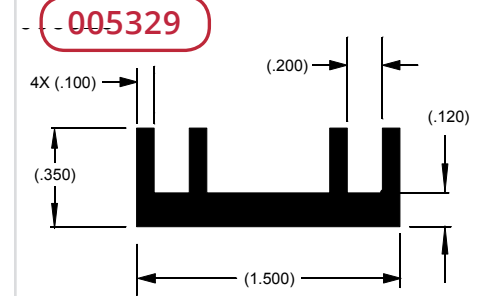

Per.	5.54	in.
WT.	0.33	lb/ft
θsa	12.70	°C/w/3"

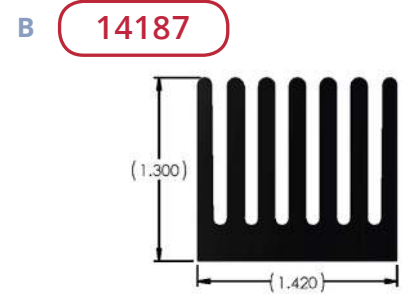

Per.	17.42	in.
WT.	1.44	lb/ft
θsa	4.01	°C/w/3"

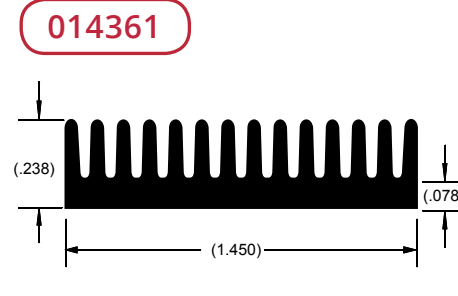

Per.	6.89	in.
WT.	0.25	lb/ft
θsa	10.20	°C/w/3"

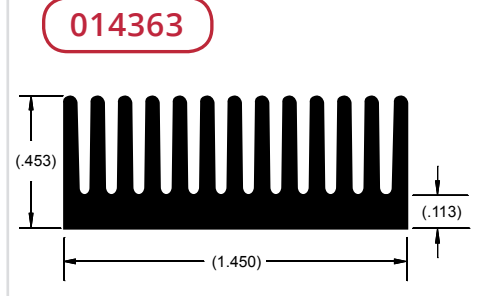

Per.	11.27	in.
WT.	0.47	lb/ft
θsa	6.20	°C/w/3"

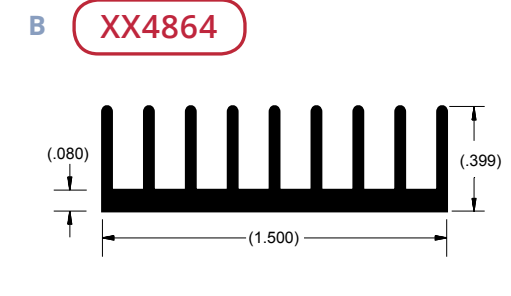

Per.	8.47	in.
WT.	0.28	lb/ft
θsa	9.60	°C/w/3"

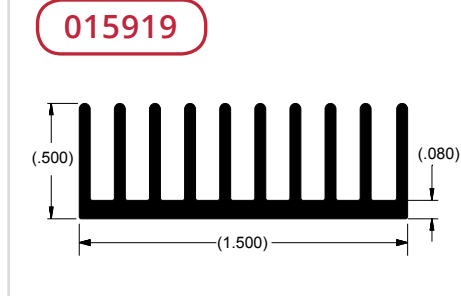

Per.	11.35	in.
WT.	0.39	lb/ft
θsa	7.70	°C/w/3"

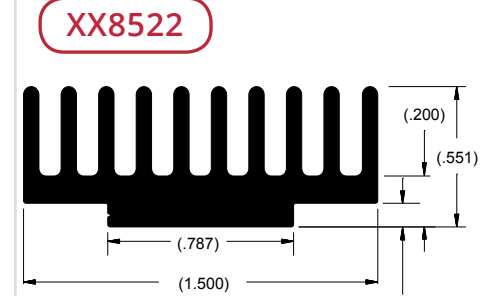

Per.	9.88	in.
WT.	0.55	lb/ft
θsa	9.80	°C/w/3"

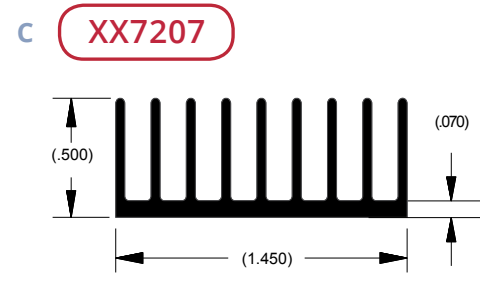

Per.	10.78	in.
WT.	0.33	lb/ft
θsa	7.00	°C/w/3"

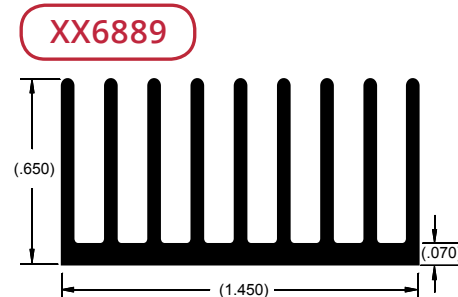

Per.	13.20	in.
WT.	0.40	lb/ft
θsa	6.20	°C/w/3"

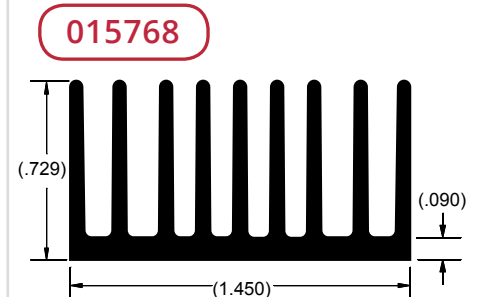

Per.	14.12	in.
WT.	0.54	lb/ft
θsa	6.20	°C/w/3"

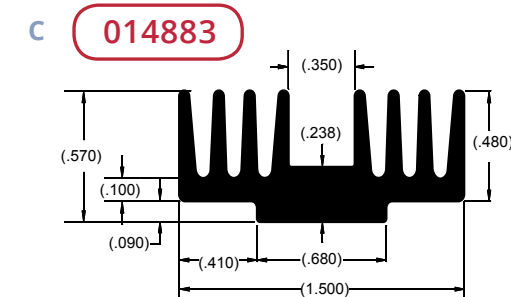

Per.	8.65	in.
WT.	0.51	lb/ft
θsa	8.10	°C/w/3"

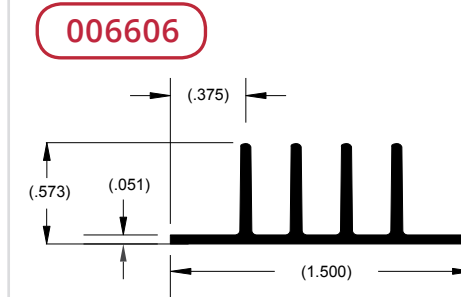

Per.	7.07	in.
WT.	0.23	lb/ft
θsa	9.60	°C/w/3"

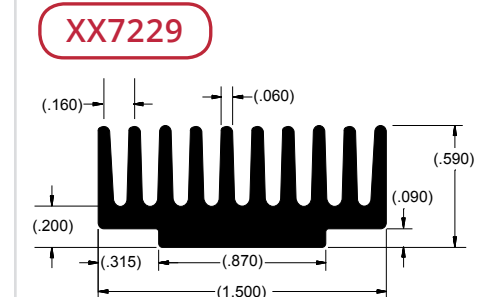

Per.	10.40	in.
WT.	0.61	lb/ft
θsa	7.00	°C/w/3"

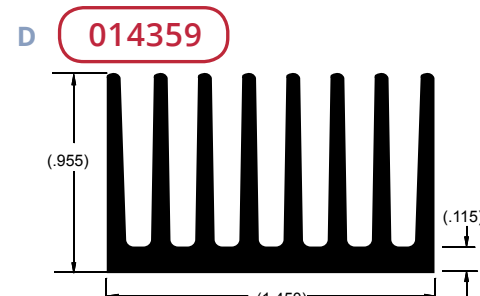

Per.	15.97	in.
WT.	0.70	lb/ft
θsa	4.40	°C/w/3"

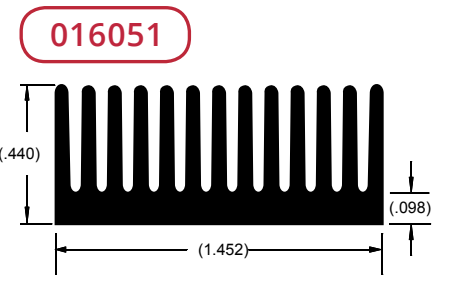

Per.	11.25	in.
WT.	0.47	lb/ft
θsa	9.40	°C/w/3"

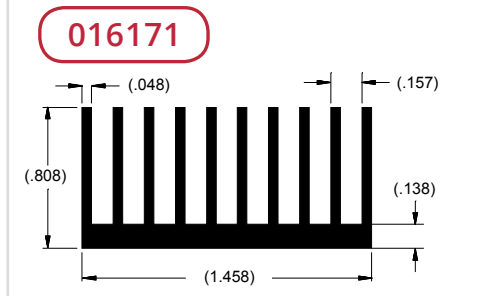

Per.	16.56	in.
WT.	0.63	lb/ft
θsa	5.70	°C/w/3"

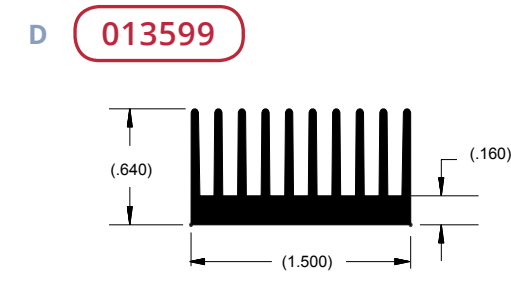

Per.	12.72	in.
WT.	6.07	lb/ft
θsa	6.80	°C/w/3"

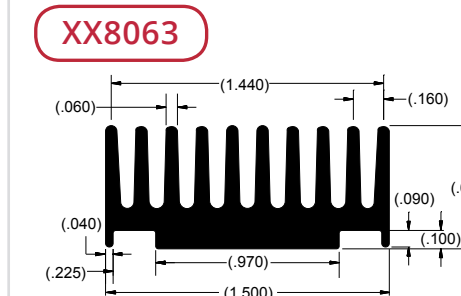

Per.	11.97	in.
WT.	0.72	lb/ft
θsa	6.00	°C/w/3"

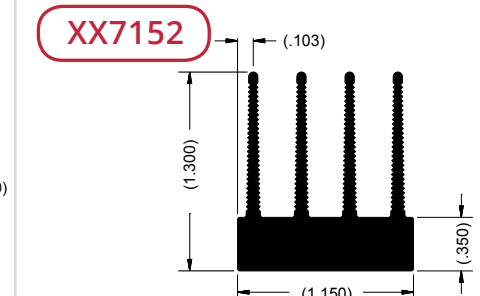

Per.	12.50	in.
WT.	0.75	lb/ft
θsa	5.00	°C/w/3"



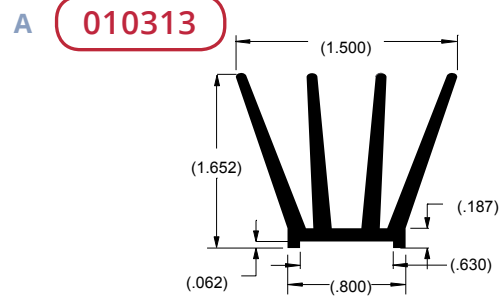

Per.	14.75	in.
WT.	0.84	lb/ft
θsa	4.70	°C/w/3"

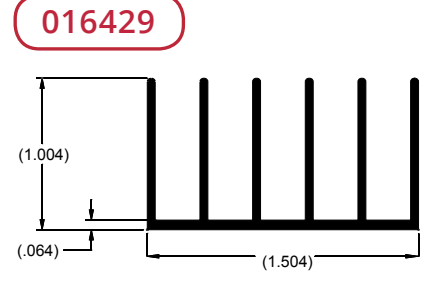

Per.	14.303	in.
WT.	0.412	lb/ft
θsa	4.90	°C/w/3"

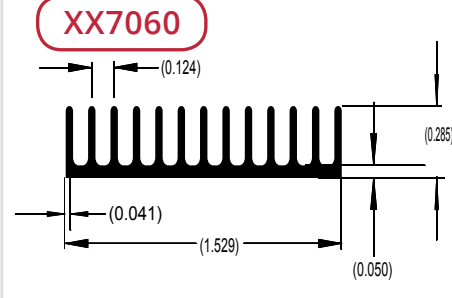

Per.	12.72	in.
WT.	0.61	lb/ft
θsa	14.00	°C/w/3"

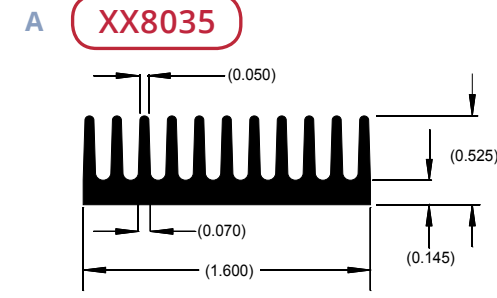

Per.	11.05	in.
WT.	0.58	lb/ft
θsa	7.00	°C/w/3"

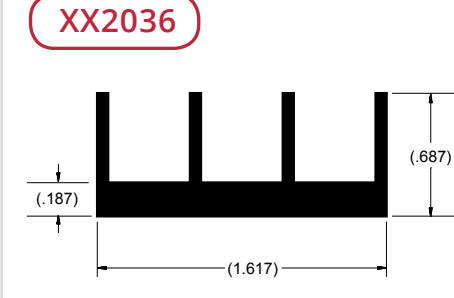

Per.	7.58	in.
WT.	0.51	lb/ft
θsa	4.90	°C/w/3"

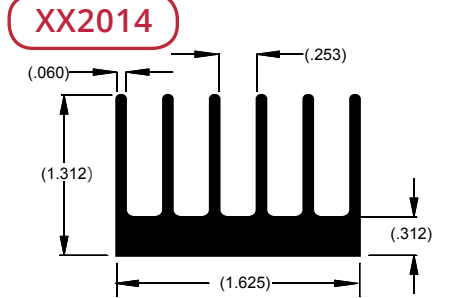

Per.	15.45	in.
WT.	1.05	lb/ft
θsa	3.20	°C/w/3"

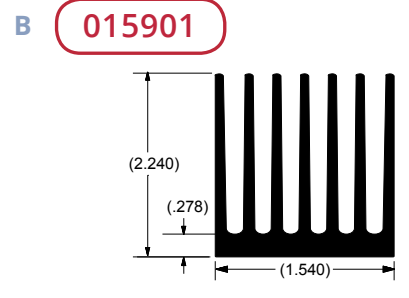

Per.	30.32	in.
WT.	1.93	lb/ft
θsa	3.30	°C/w/3"

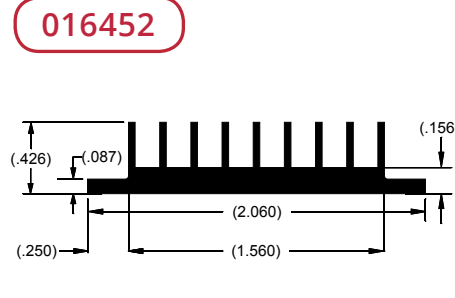

Per.	9.29	in.
WT.	0.46	lb/ft
θsa	8.10	°C/w/3"

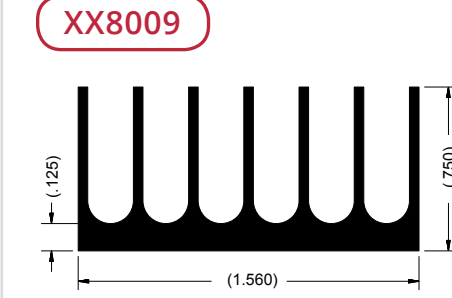

Per.	9.00	in.
WT.	0.53	lb/ft
θsa	5.50	°C/w/3"

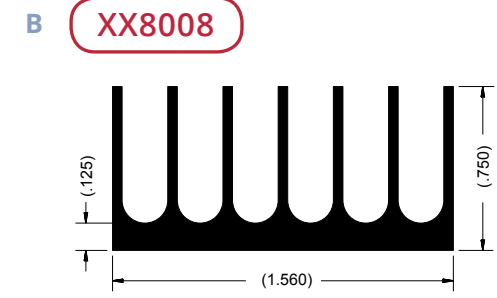

Per.	9.00	in.
WT.	0.53	lb/ft
θsa	5.50	°C/w/3"

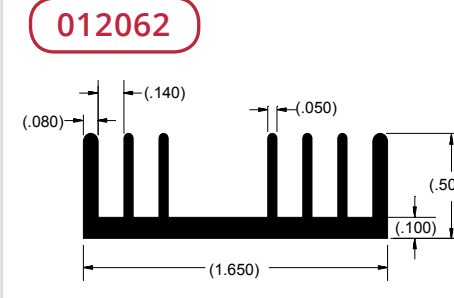

Per.	8.92	in.
WT.	0.39	lb/ft
θsa	7.80	°C/w/3"

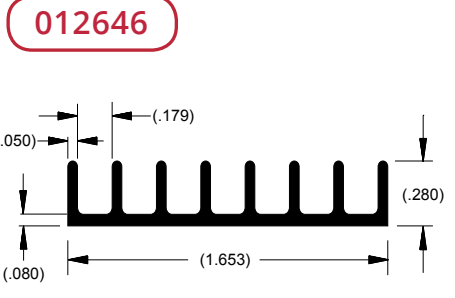

Per.	6.73	in.
WT.	0.20	lb/ft
θsa	10.40	°C/w/3"

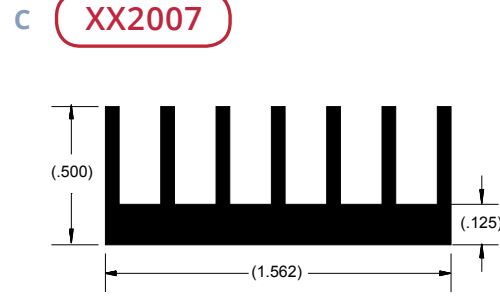

Per.	8.62	in.
WT.	0.43	lb/ft
θsa	8.00	°C/w/3"

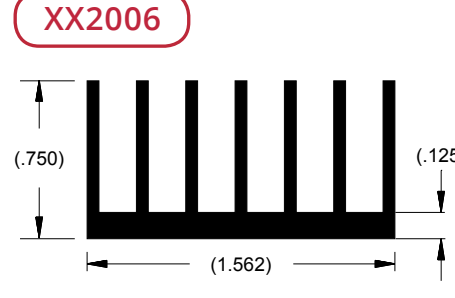

Per.	12.12	in.
WT.	0.57	lb/ft
θsa	5.40	°C/w/3"

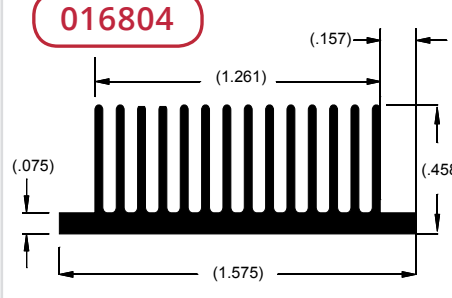

Per.	13.59	in.
WT.	0.36	lb/ft
θsa	9.80	°C/w/3"

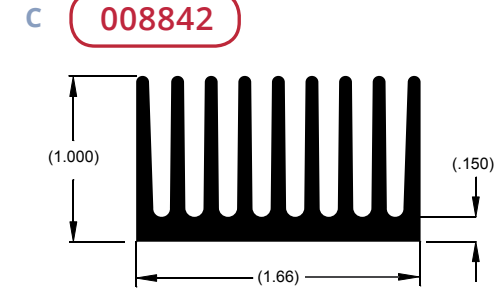

Per.	18.15	in.
WT.	1.03	lb/ft
θsa	4.90	°C/w/3"

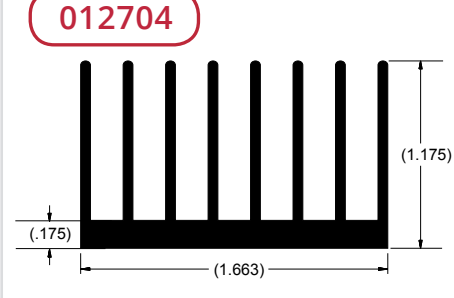

Per.	19.43	in.
WT.	0.83	lb/ft
θsa	3.60	°C/w/3"

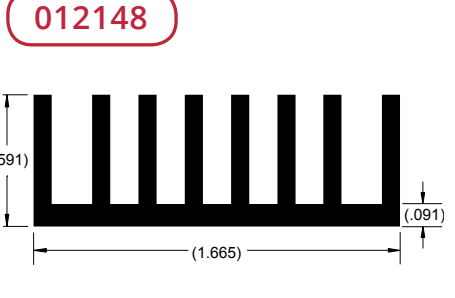

Per.	11.45	in.
WT.	0.51	lb/ft
θsa	6.10	°C/w/3"

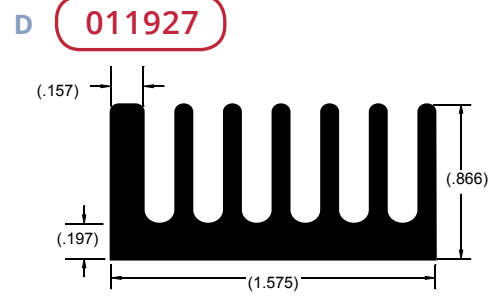

Per.	12.27	in.
WT.	0.87	lb/ft
θsa	5.70	°C/w/3"

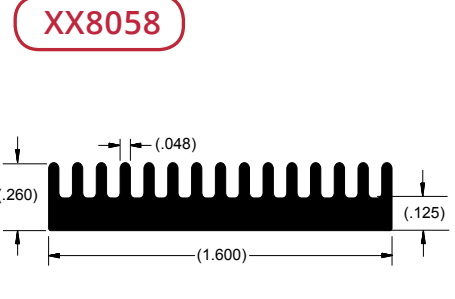

Per.	7.00	in.
WT.	0.34	lb/ft
θsa	14.00	°C/w/3"

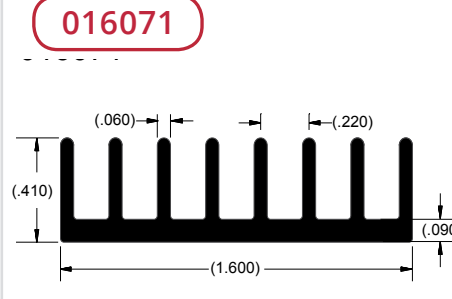

Per.	8.20	in.
WT.	0.36	lb/ft
θsa	8.30	°C/w/3"

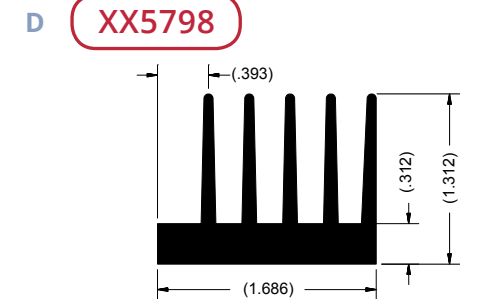

Per.	13.66	in.
WT.	1.04	lb/ft
θsa	5.30	°C/w/3"

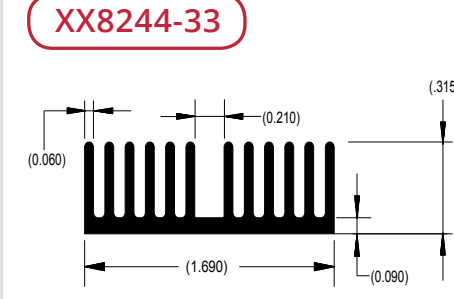

Per.	8.40	in.
WT.	0.37	lb/ft
θsa	10.00	°C/w/3"

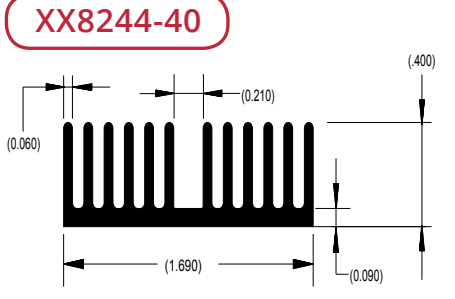

Per.	10.40	in.
WT.	0.45	lb/ft
θsa	9.30	°C/w/3"

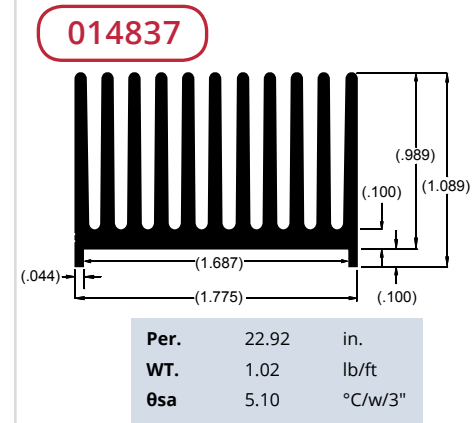
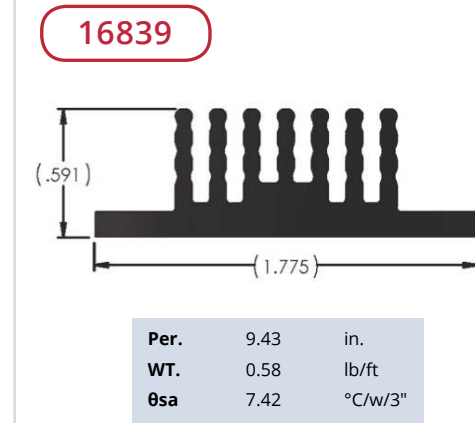
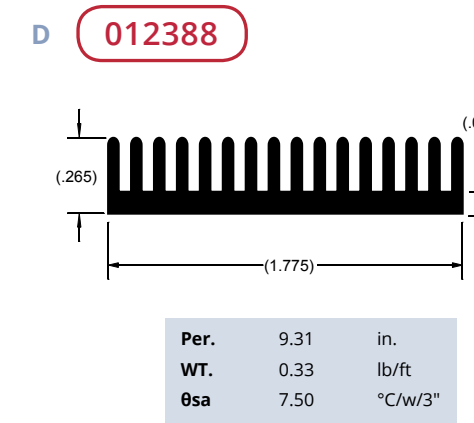
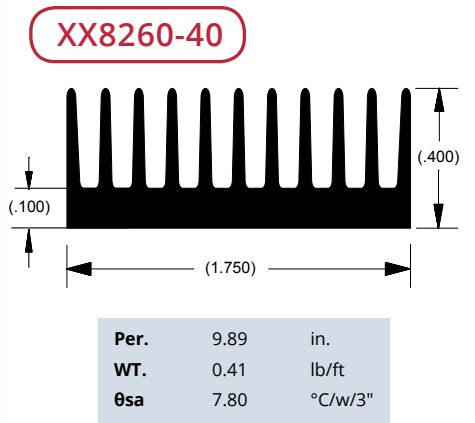
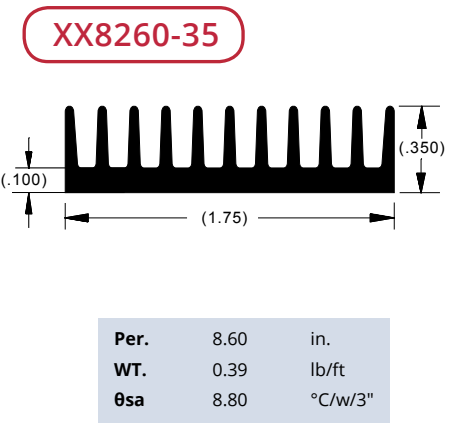
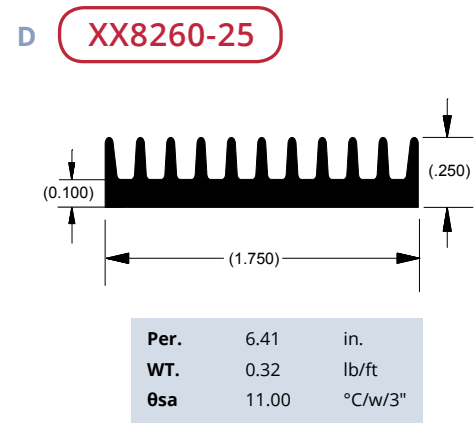
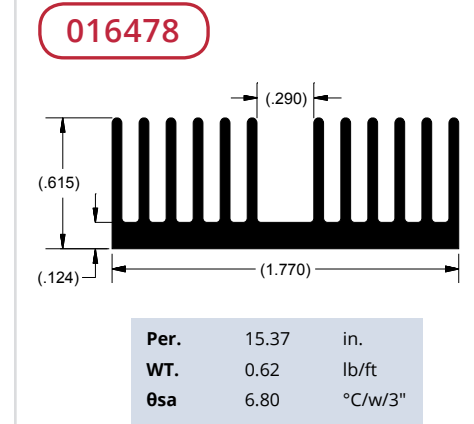
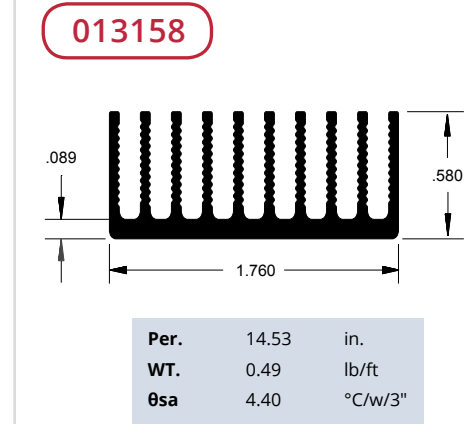
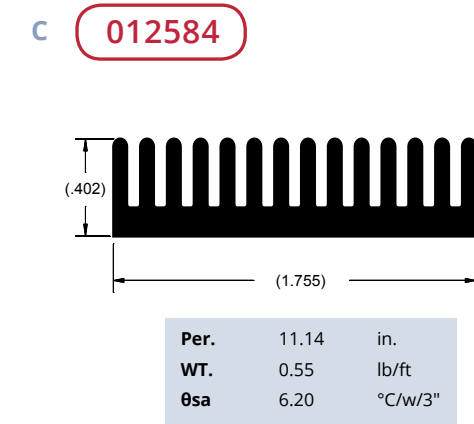
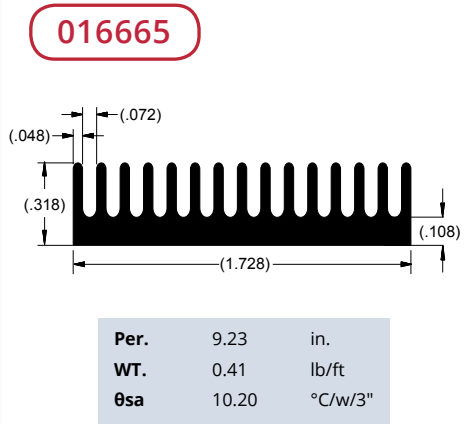
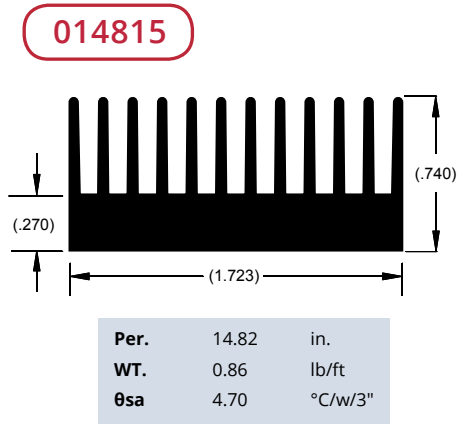
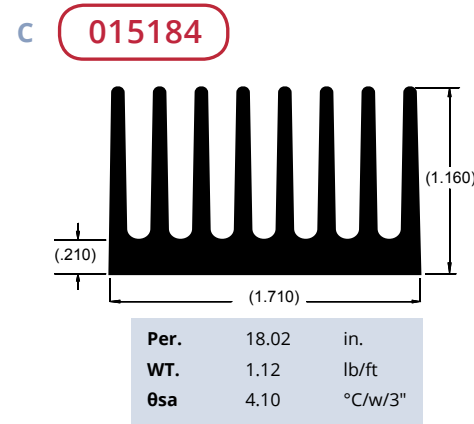
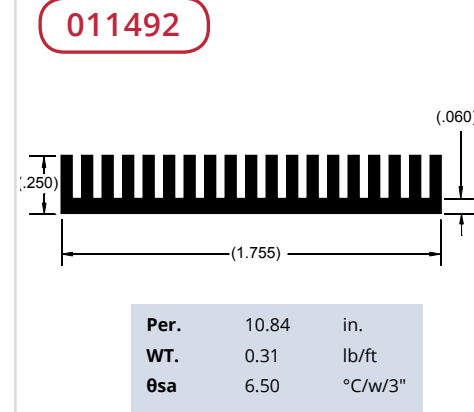
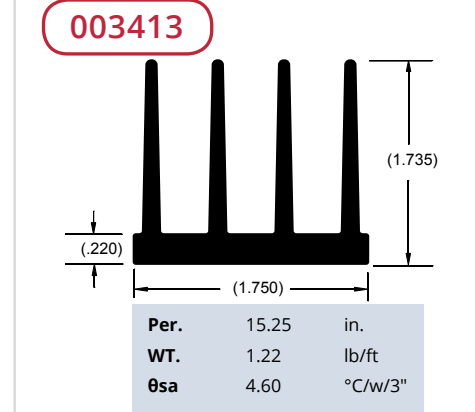
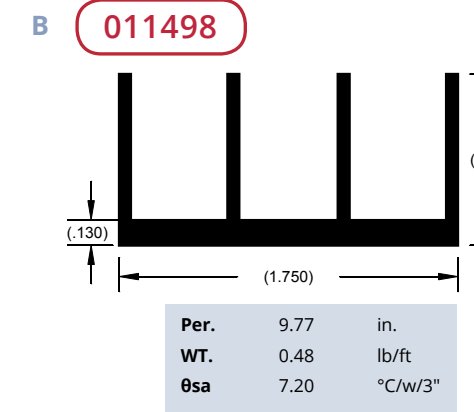
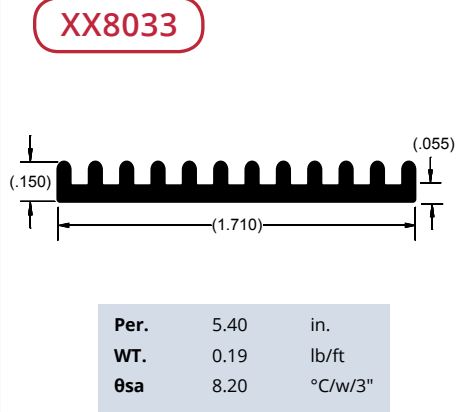
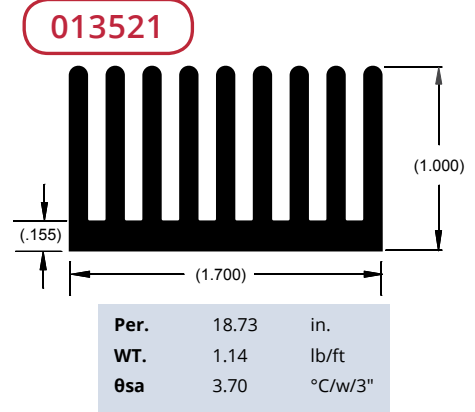
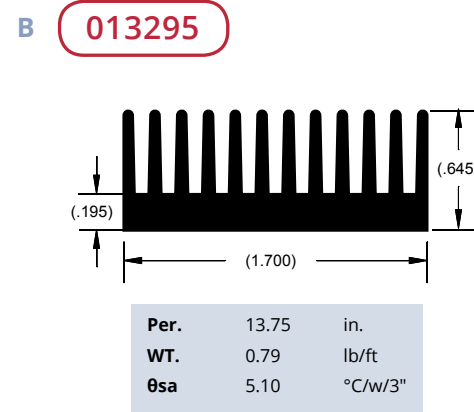
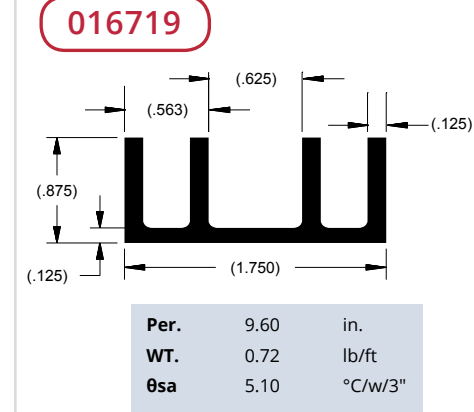
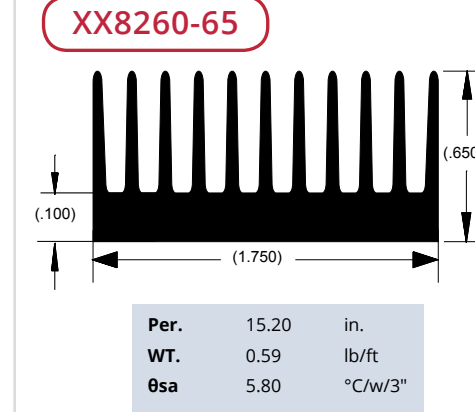
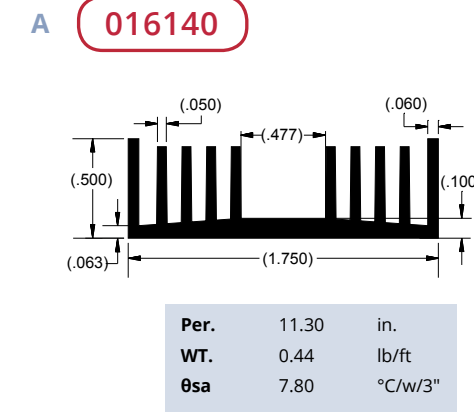
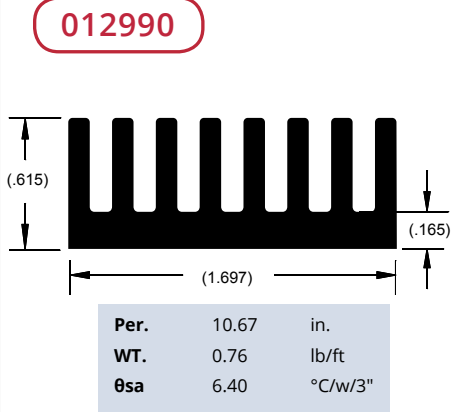
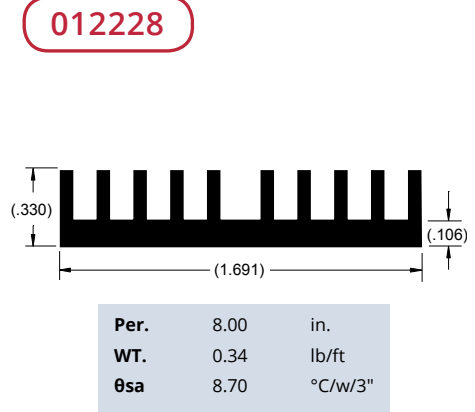
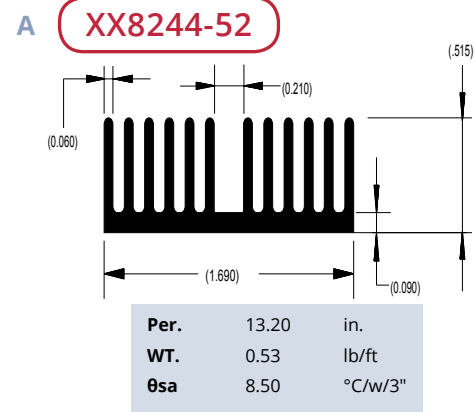

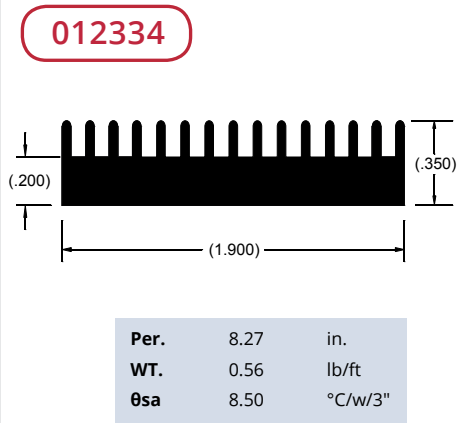
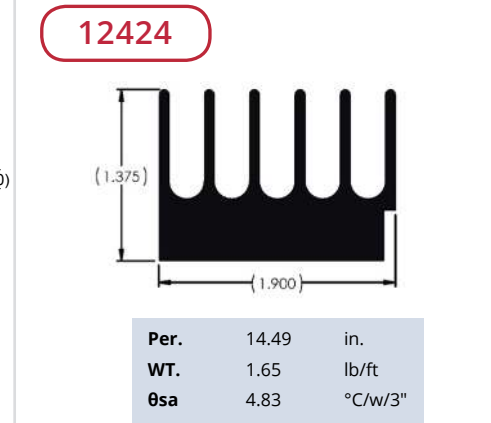
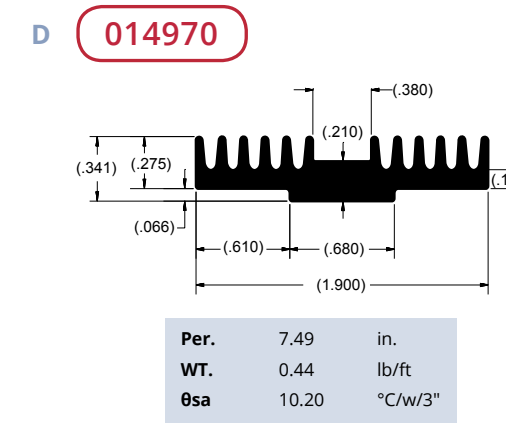
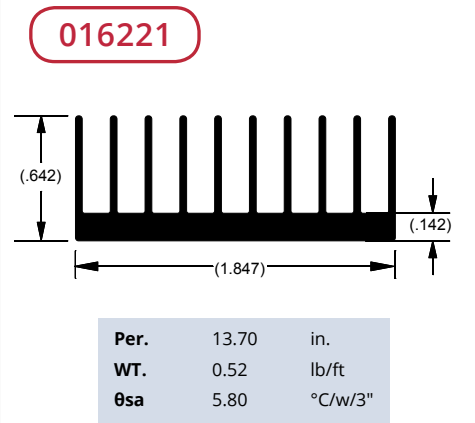
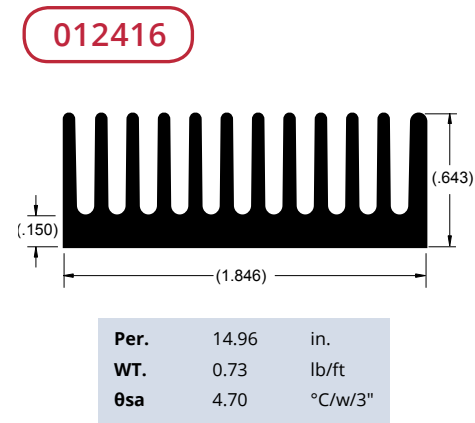
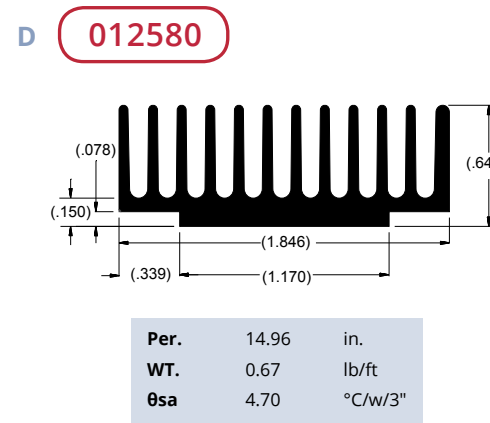
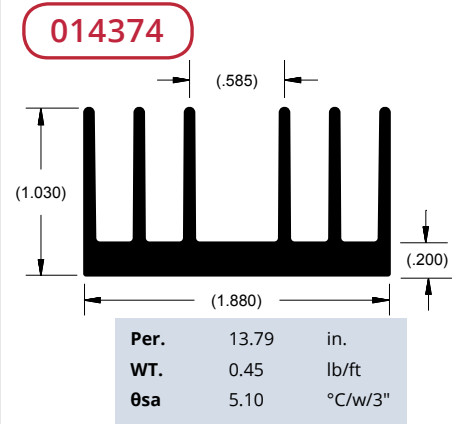
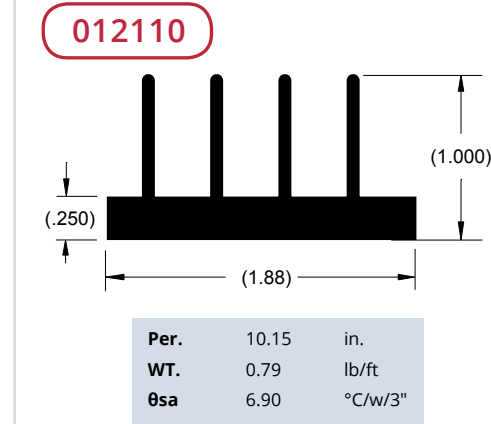
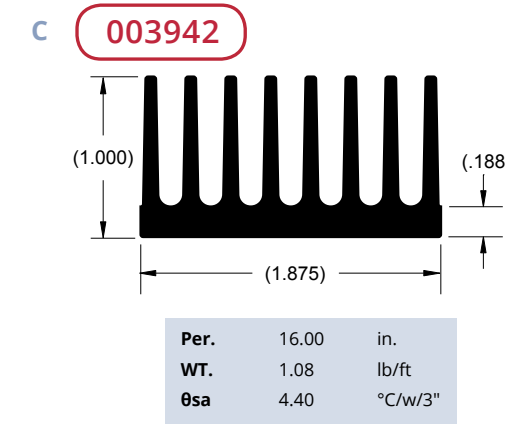
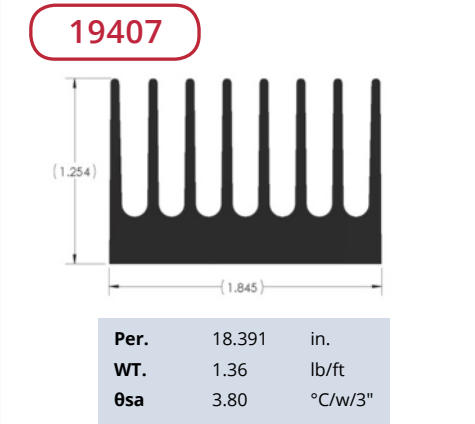
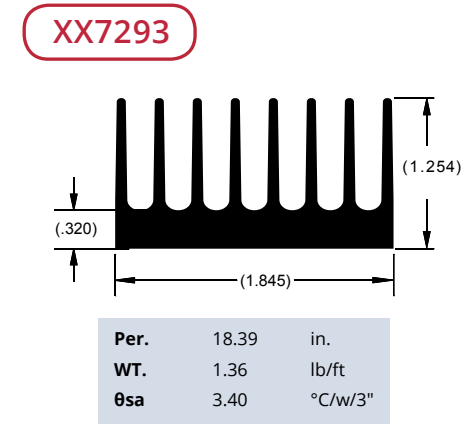
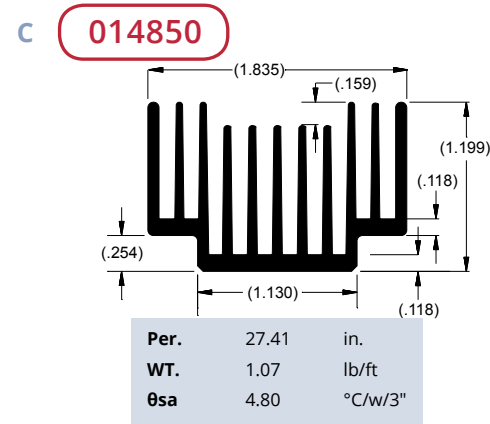
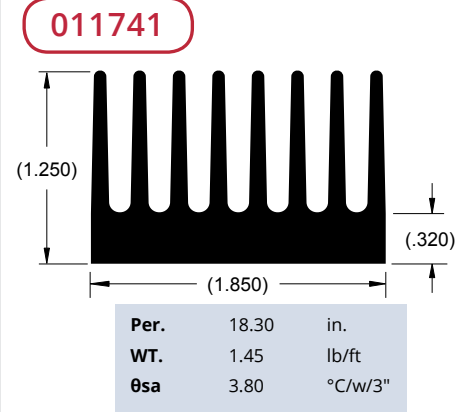
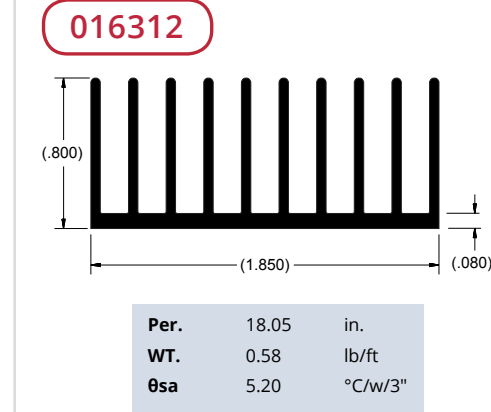
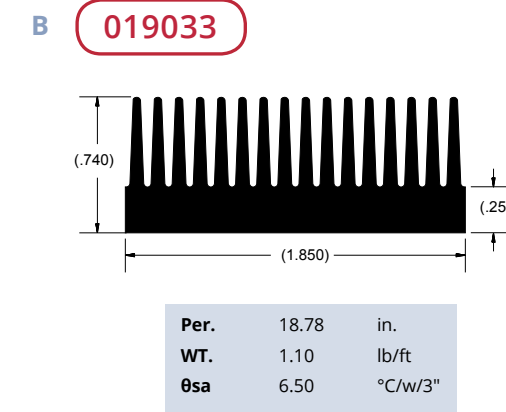
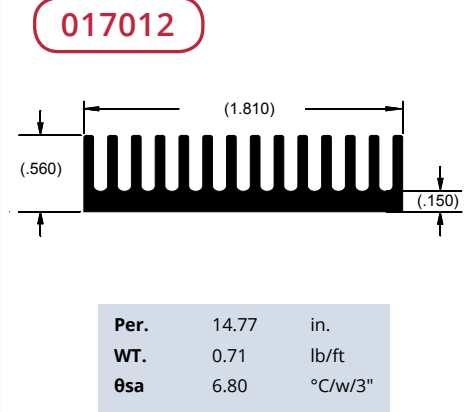
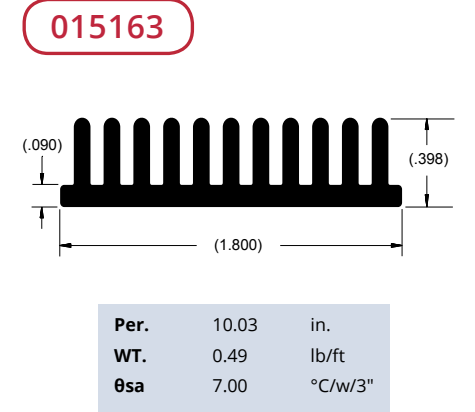
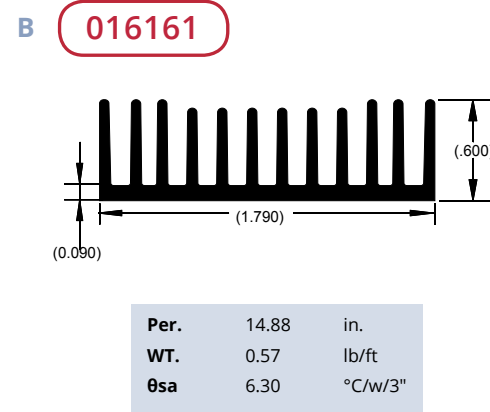
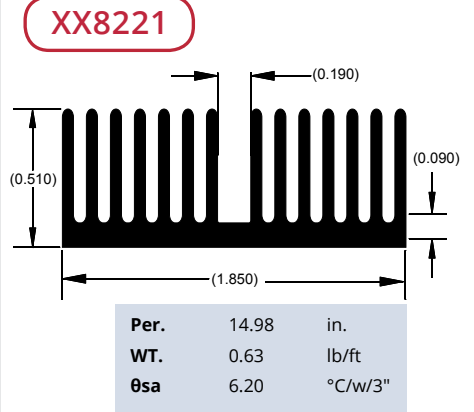
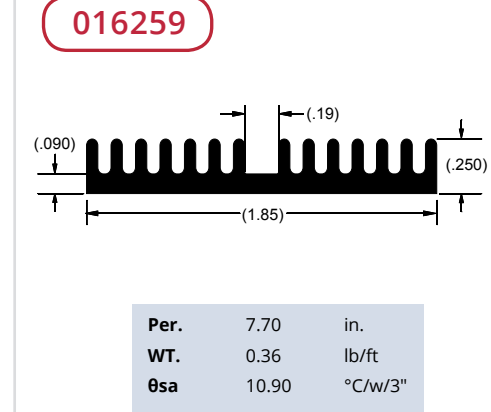
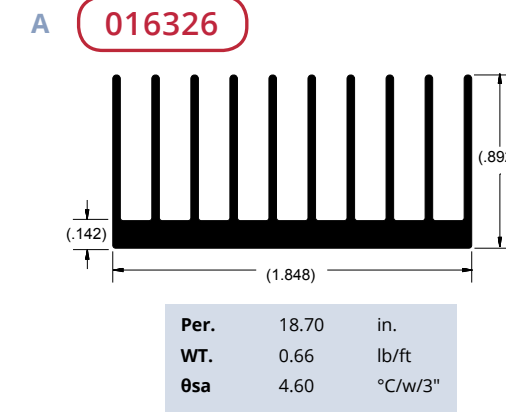
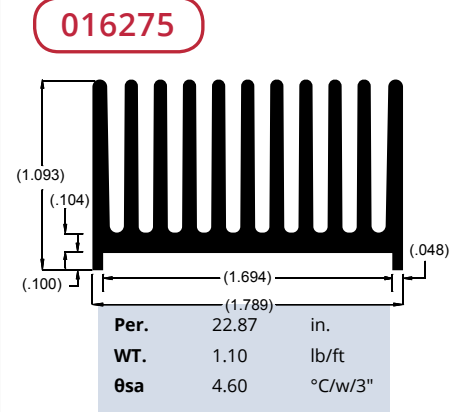
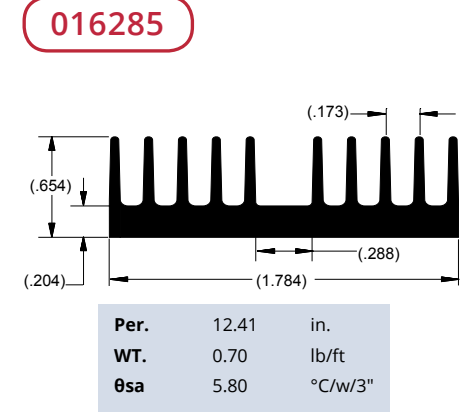
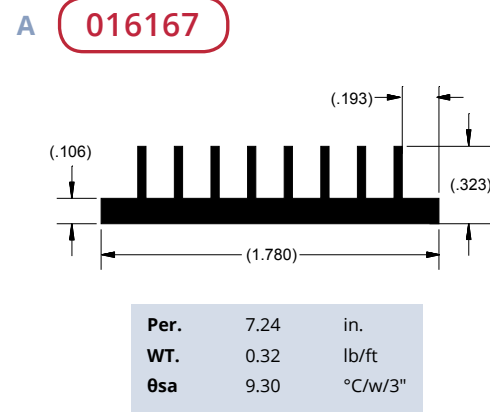



**A 15672**

Per.	12.95	in.
WT.	0.45	lb/ft
θsa	5.40	°C/w/3"

**015672**

Per.	17.78	in.
WT.	0.45	lb/ft
θsa	7.00	°C/w/3"

**012246**

Per.	15.39	in.
WT.	0.56	lb/ft
θsa	4.50	°C/w/3"

**A 013208**

Per.	18.07	in.
WT.	0.87	lb/ft
θsa	3.90	°C/w/3"

**013210**

Per.	20.61	in.
WT.	0.97	lb/ft
θsa	3.40	°C/w/3"

**015921**

Per.	7.86	in.
WT.	0.31	lb/ft
θsa	11.50	°C/w/3"

**B 013151**

Per.	13.69	in.
WT.	0.77	lb/ft
θsa	5.10	°C/w/3"

**XX2239**

Per.	13.56	in.
WT.	0.78	lb/ft
θsa	5.70	°C/w/3"

**011448**

Per.	14.76	in.
WT.	0.60	lb/ft
θsa	4.70	°C/w/3"

**B 016650**

Per.	11.98	in.
WT.	0.38	lb/ft
θsa	8.00	°C/w/3"

**004506**

Per.	11.50	in.
WT.	0.55	lb/ft
θsa	6.10	°C/w/3"

**014727**

Per.	13.66	in.
WT.	0.76	lb/ft
θsa	5.10	°C/w/3"

**C 016436**

Per.	9.20	in.
WT.	0.34	lb/ft
θsa	12.00	°C/w/3"

**008702**

Per.	18.34	in.
WT.	1.08	lb/ft
θsa	3.80	°C/w/3"

**XX8195**

Per.	77.43	in.
WT.	0.37	lb/ft
θsa	10.00	°C/w/3"

**C 013075**

Per.	25.12	in.
WT.	2.35	lb/ft
θsa	2.80	°C/w/3"

**016149**

Per.	24.02	in.
WT.	2.75	lb/ft
θsa	3.10	°C/w/3"

**016428**

Per.	21.98	in.
WT.	0.83	lb/ft
θsa	4.20	°C/w/3"

**D 011465**

Per.	10.46	in.
WT.	0.85	lb/ft
θsa	6.70	°C/w/3"

**013205**

Per.	10.63	in.
WT.	0.53	lb/ft
θsa	6.60	°C/w/3"

**013206**

Per.	13.63	in.
WT.	0.63	lb/ft
θsa	5.10	°C/w/3"

**D 012106**

Per.	22.81	in.
WT.	1.33	lb/ft
θsa	3.10	°C/w/3"

**014432**

Per.	8.15	in.
WT.	0.36	lb/ft
θsa	8.60	°C/w/3"

**010980**

Per.	15.60	in.
WT.	0.65	lb/ft
θsa	4.50	°C/w/3"

**A 016172**

Per.	19.10	in.
WT.	0.76	lb/ft
θsa	4.70	°C/w/3"

**016555**

Per.	15.29	in.
WT.	0.87	lb/ft
θsa	4.70	°C/w/3"

**014476**

Per.	15.75	in.
WT.	0.74	lb/ft
θsa	4.40	°C/w/3"

**A XX8641**

Per.	22.60	in.
WT.	1.36	lb/ft
θsa	5.20	°C/w/3"

**014235**

Per.	29.12	in.
WT.	1.79	lb/ft
θsa	2.40	°C/w/3"

**013647**

Per.	29.92	in.
WT.	1.41	lb/ft
θsa	2.60	°C/w/3"

**B 012712**

Per.	11.20	in.
WT.	0.30	lb/ft
θsa	6.20	°C/w/3"

**XX8355-40**

Per.	9.44	in.
WT.	0.67	lb/ft
θsa	7.00	°C/w/3"

**012182**

Per.	7.74	in.
WT.	0.36	lb/ft
θsa	9.00	°C/w/3"

**B 015955**

Per.	9.95	in.
WT.	0.43	lb/ft
θsa	7.40	°C/w/3"

**014802**

Per.	13.81	in.
WT.	0.53	lb/ft
θsa	6.10	°C/w/3"

**012103**

Per.	15.65	in.
WT.	0.72	lb/ft
θsa	4.50	°C/w/3"

**C 011740**

Per.	16.23	in.
WT.	0.45	lb/ft
θsa	4.30	°C/w/3"

**XX8355-65**

Per.	14.90	in.
WT.	0.95	lb/ft
θsa	5.20	°C/w/3"

**012242**

Per.	20.64	in.
WT.	0.68	lb/ft
θsa	3.40	°C/w/3"

**C 014249**

Per.	15.85	in.
WT.	1.18	lb/ft
θsa	4.40	°C/w/3"

**009239**

Per.	25.15	in.
WT.	2.23	lb/ft
θsa	2.80	°C/w/3"

**21884**

Per.	18.60	in.
WT.	3.49	lb/ft
θsa	3.76	°C/w/3"

**D 013513**

Per.	16.26	in.
WT.	0.97	lb/ft
θsa	4.30	°C/w/3"

**XX8355-80**

Per.	18.200	in.
WT.	1.120	lb/ft
θsa	4.40	°C/w/3"

**XX8355-100**

Per.	22.64	in.
WT.	1.39	lb/ft
θsa	3.80	°C/w/3"

**D 016510**

Per.	17.92	in.
WT.	1.09	lb/ft
θsa	4.80	°C/w/3"

**016256**

Per.	21.86	in.
WT.	1.28	lb/ft
θsa	5.10	°C/w/3"

**XX2035**

Per.	9.64	in.
WT.	0.66	lb/ft
θsa	4.30	°C/w/3"

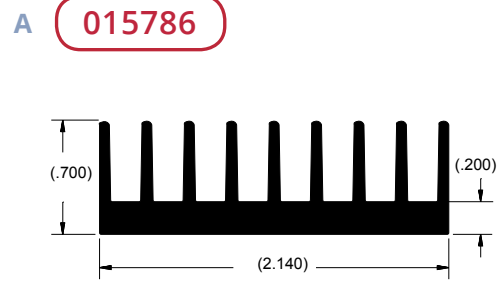

Per.	13.24	in.
WT.	0.87	lb/ft
θsa	5.10	°C/w/3"

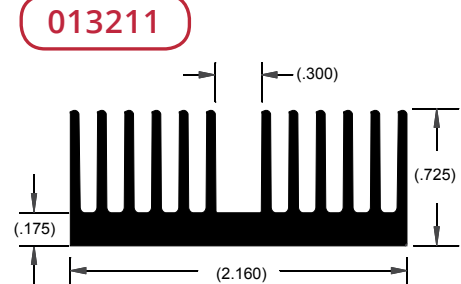

Per.	17.21	in.
WT.	0.90	lb/ft
θsa	4.10	°C/w/3"

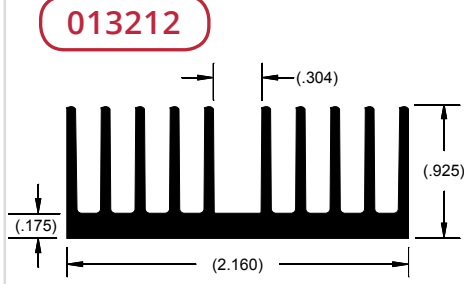

Per.	19.13	in.
WT.	0.96	lb/ft
θsa	3.70	°C/w/3"

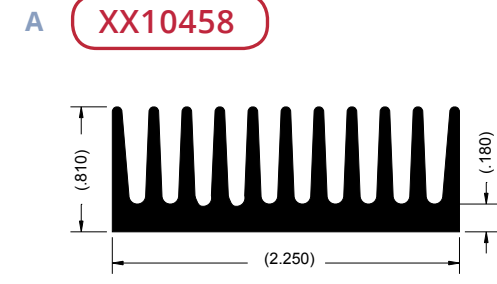

Per.	17.49	in.
WT.	1.21	lb/ft
θsa	4.80	°C/w/3"

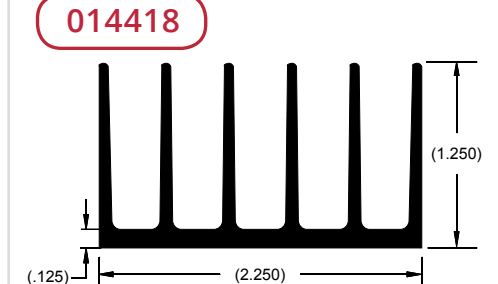

Per.	18.25	in.
WT.	0.84	lb/ft
θsa	3.80	°C/w/3"

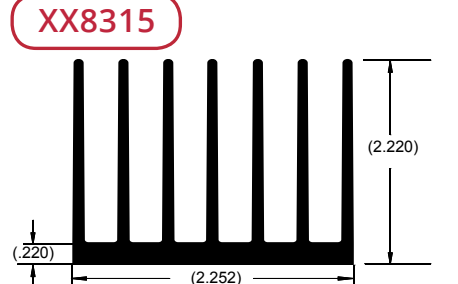

Per.	32.42	in.
WT.	1.79	lb/ft
θsa	2.40	°C/w/3"

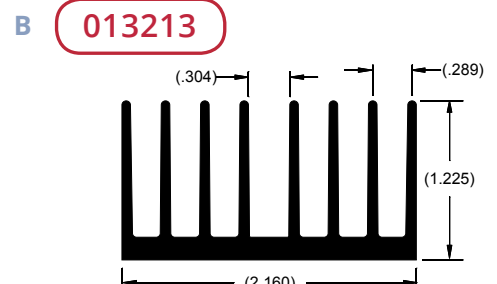

Per.	20.97	in.
WT.	1.12	lb/ft
θsa	3.30	°C/w/3"

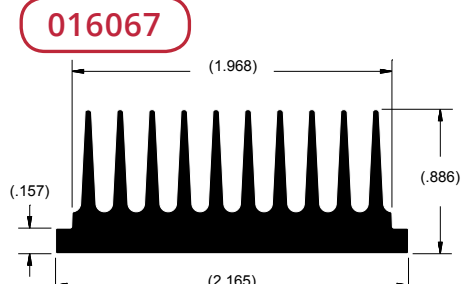

Per.	16.25	in.
WT.	1.17	lb/ft
θsa	5.20	°C/w/3"

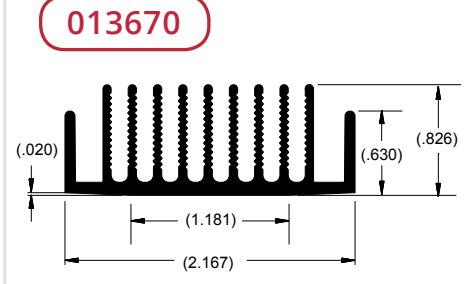

Per.	21.91	in.
WT.	0.81	lb/ft
θsa	3.20	°C/w/3"

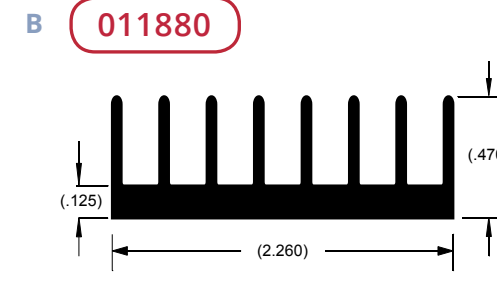

Per.	10.24	in.
WT.	0.54	lb/ft
θsa	6.80	°C/w/3"

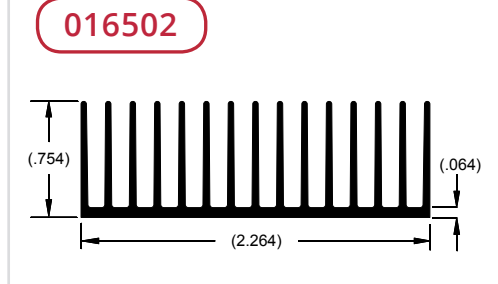

Per.	24.75	in.
WT.	0.67	lb/ft
θsa	4.80	°C/w/3"

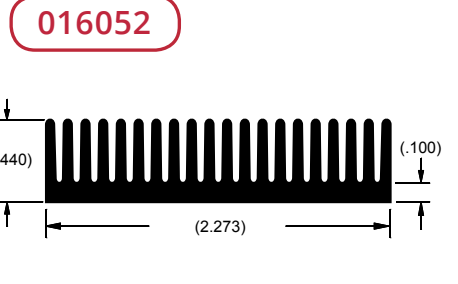

Per.	17.71	in.
WT.	0.72	lb/ft
θsa	7.60	°C/w/3"

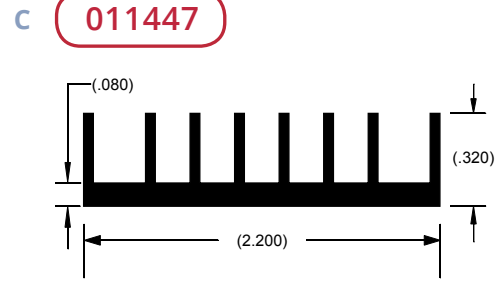

Per.	8.34	in.
WT.	0.34	lb/ft
θsa	8.40	°C/w/3"

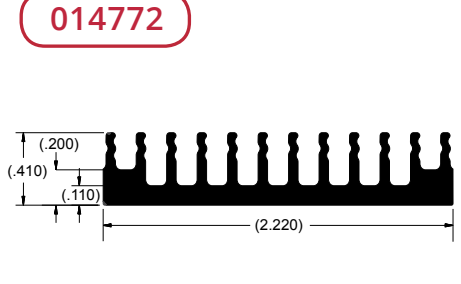

Per.	11.28	in.
WT.	0.56	lb/ft
θsa	7.00	°C/w/3"

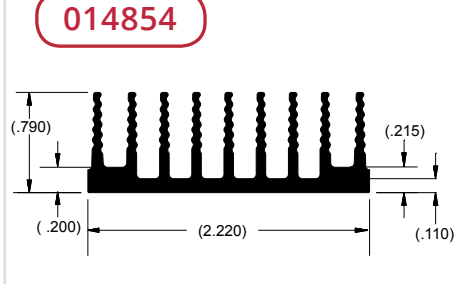

Per.	17.46	in.
WT.	0.80	lb/ft
θsa	4.60	°C/w/3"

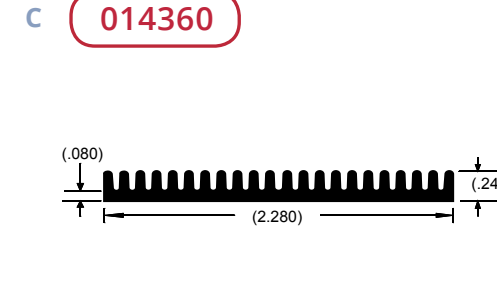

Per.	10.93	in.
WT.	0.39	lb/ft
θsa	10.40	°C/w/3"

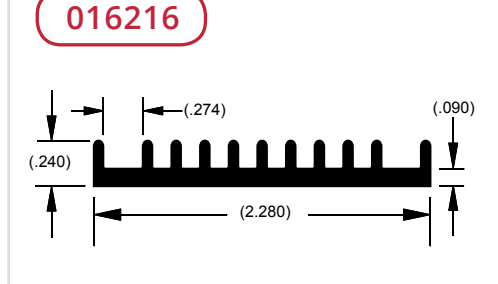

Per.	7.58	in.
WT.	0.36	lb/ft
θsa	9.20	°C/w/3"

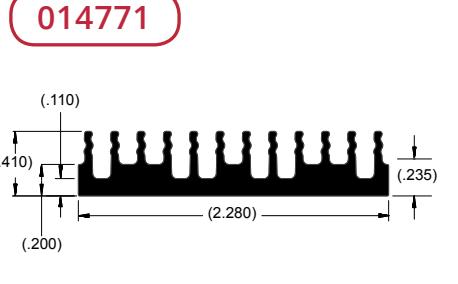

Per.	10.79	in.
WT.	0.63	lb/ft
θsa	7.80	°C/w/3"

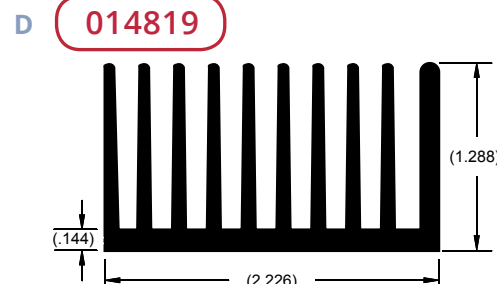

Per.	27.09	in.
WT.	1.48	lb/ft
θsa	3.50	°C/w/3"

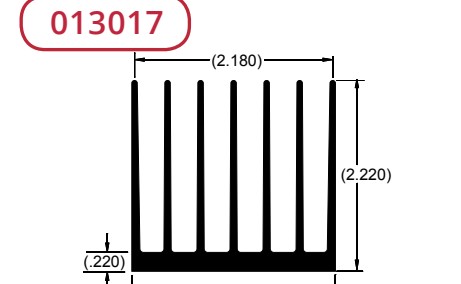

Per.	32.38	in.
WT.	1.79	lb/ft
θsa	2.40	°C/w/3"

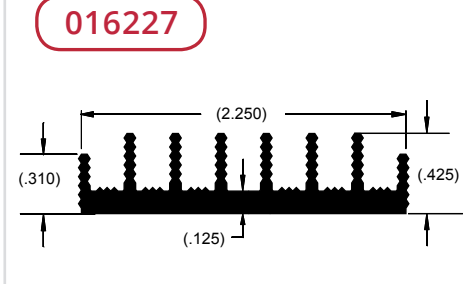

Per.	10.50	in.
WT.	0.53	lb/ft
θsa	6.60	°C/w/3"

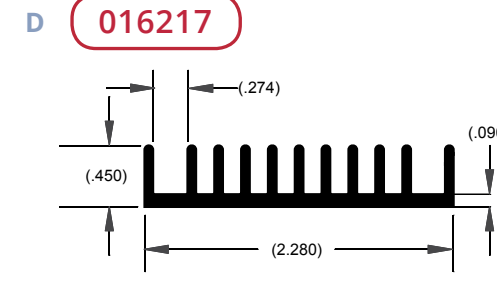

Per.	12.21	in.
WT.	0.52	lb/ft
θsa	6.40	°C/w/3"

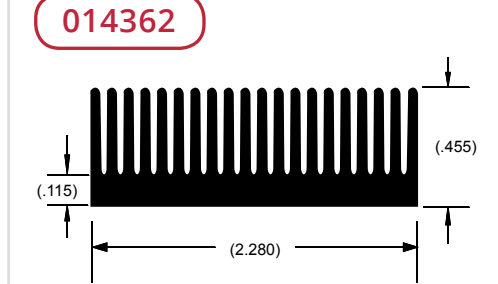

Per.	17.31	in.
WT.	0.73	lb/ft
θsa	4.00	°C/w/3"

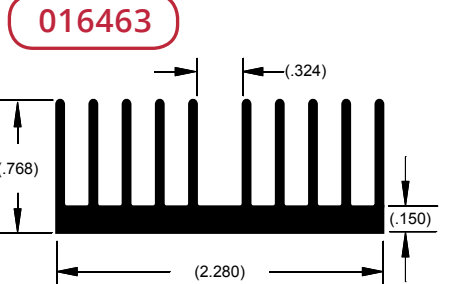

Per.	18.17	in.
WT.	0.75	lb/ft
θsa	4.20	°C/w/3"



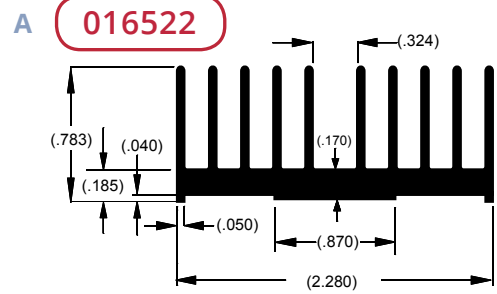

Per.	16.65	in.
WT.	0.79	lb/ft
θsa	4.80	°C/w/3"

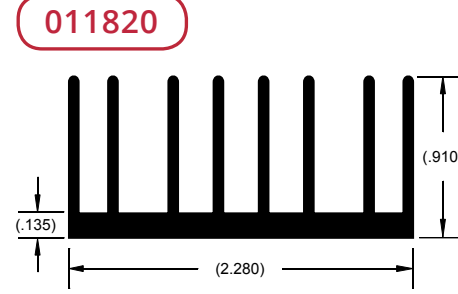

Per.	17.02	in.
WT.	0.81	lb/ft
θsa	4.10	°C/w/3"

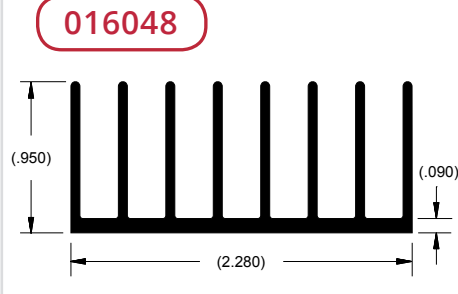

Per.	18.17	in.
WT.	0.75	lb/ft
θsa	4.20	°C/w/3"

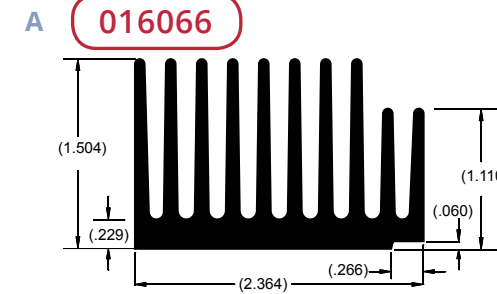

Per.	27.93	in.
WT.	1.95	lb/ft
θsa	3.20	°C/w/3"

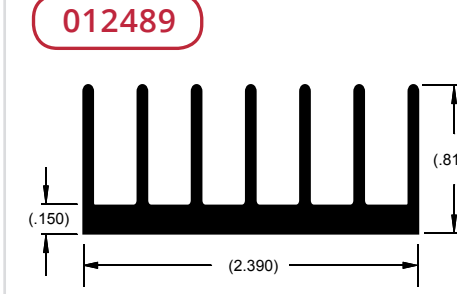

Per.	12.18	in.
WT.	0.79	lb/ft
θsa	5.70	°C/w/3"

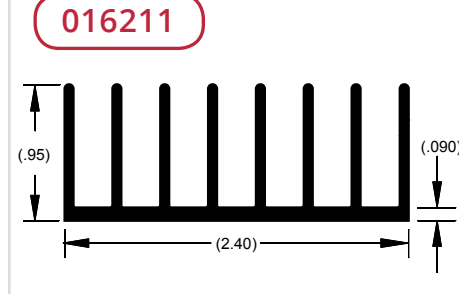

Per.	18.43	in.
WT.	0.75	lb/ft
θsa	3.80	°C/w/3"

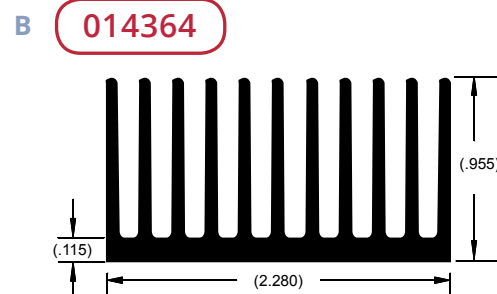

Per.	22.46	in.
WT.	1.03	lb/ft
θsa	3.10	°C/w/3"

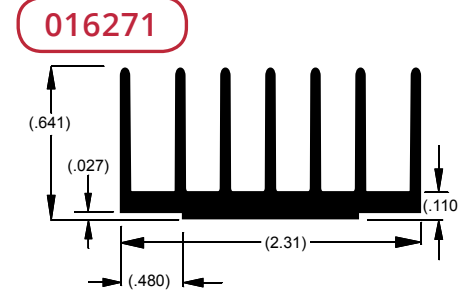

Per.	11.95	in.
WT.	0.56	lb/ft
θsa	5.10	°C/w/3"



Per.	22.26	in.
WT.	1.88	lb/ft
θsa	3.10	°C/w/3"

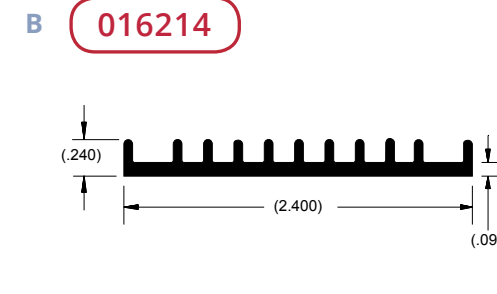

Per.	7.82	in.
WT.	0.37	lb/ft
θsa	9.10	°C/w/3"

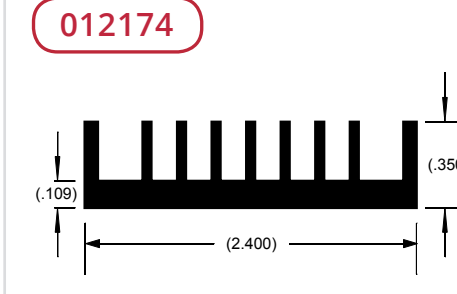

Per.	9.29	in.
WT.	0.48	lb/ft
θsa	7.50	°C/w/3"

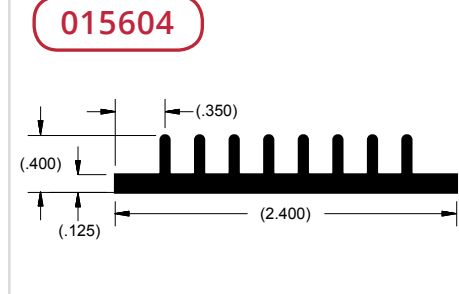

Per.	9.14	in.
WT.	0.51	lb/ft
θsa	8.00	°C/w/3"

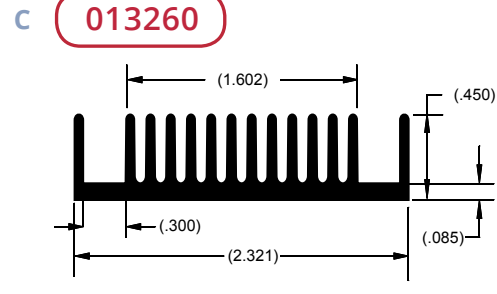

Per.	14.21	in.
WT.	0.58	lb/ft
θsa	4.90	°C/w/3"

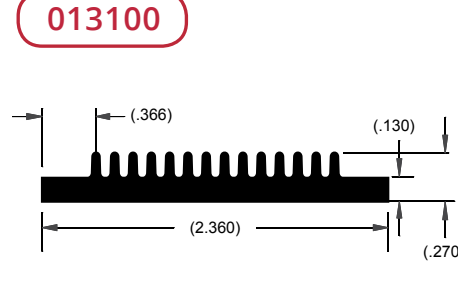

Per.	8.13	in.
WT.	0.48	lb/ft
θsa	8.60	°C/w/3"

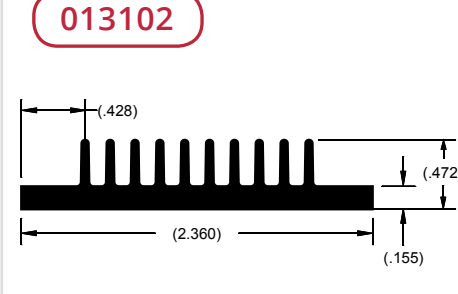

Per.	10.56	in.
WT.	0.63	lb/ft
θsa	6.60	°C/w/3"

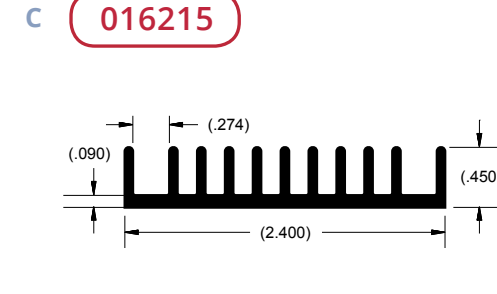

Per.	12.44	in.
WT.	0.54	lb/ft
θsa	6.30	°C/w/3"

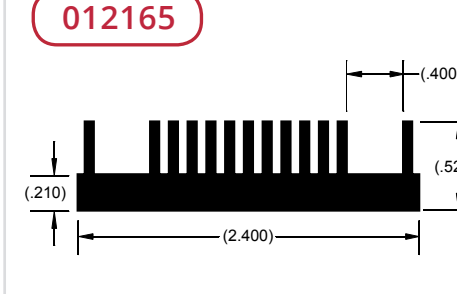

Per.	13.17	in.
WT.	0.87	lb/ft
θsa	5.30	°C/w/3"

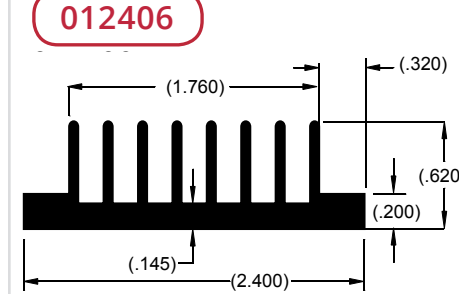

Per.	12.42	in.
WT.	0.71	lb/ft
θsa	5.60	°C/w/3"

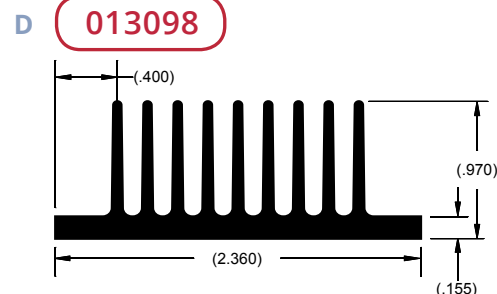

Per.	18.88	in.
WT.	0.95	lb/ft
θsa	3.70	°C/w/3"

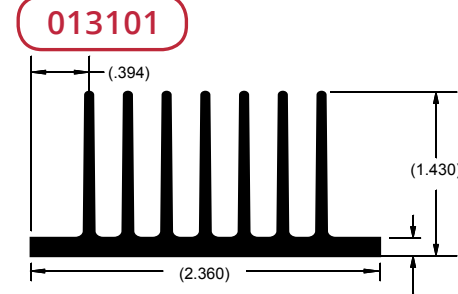

Per.	22.23	in.
WT.	1.07	lb/ft
θsa	3.10	°C/w/3"

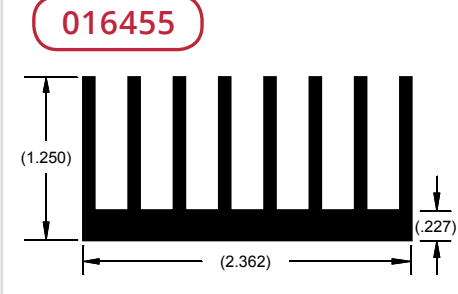

Per.	21.56	in.
WT.	1.42	lb/ft
θsa	3.30	°C/w/3"

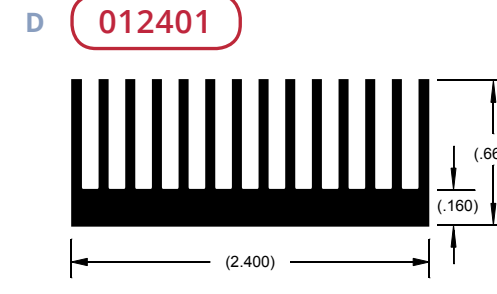

Per.	18.95	in.
WT.	0.86	lb/ft
θsa	3.70	°C/w/3"

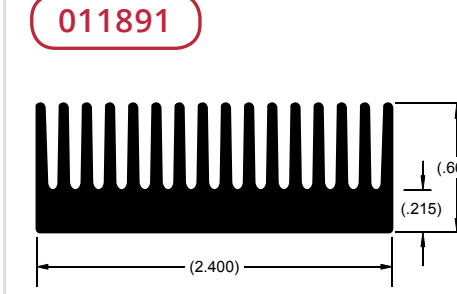

Per.	18.44	in.
WT.	1.25	lb/ft
θsa	3.80	°C/w/3"

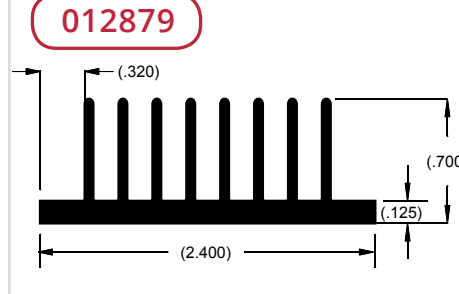

Per.	14.68	in.
WT.	0.70	lb/ft
θsa	4.80	°C/w/3"

**A 12540**

Per.	16.18	in.
WT.	0.87	lb/ft
θsa	4.32	°C/w/3"

**014964**

Per.	21.36	in.
WT.	0.79	lb/ft
θsa	3.30	°C/w/3"

**12407**

Per.	12.41	in.
WT.	0.90	lb/ft
θsa	5.64	°C/w/3"

**A 014326**

Per.	35.57	in.
WT.	1.30	lb/ft
θsa	2.00	°C/w/3"

**12487**

Per.	9.13	in.
WT.	0.48	lb/ft
θsa	7.66	°C/w/3"

**016618**

Per.	11.47	in.
WT.	0.60	lb/ft
θsa	7.30	°C/w/3"

**B 012613**

Per.	17.24	in.
WT.	0.80	lb/ft
θsa	4.10	°C/w/3"

**014427**

Per.	23.40	in.
WT.	0.89	lb/ft
θsa	3.00	°C/w/3"

**014373**

Per.	25.35	in.
WT.	1.13	lb/ft
θsa	2.80	°C/w/3"

**B 015941**

Per.	9.77	in.
WT.	0.38	lb/ft
θsa	9.30	°C/w/3"

**015920**

Per.	11.43	in.
WT.	0.43	lb/ft
θsa	8.40	°C/w/3"

**014269**

Per.	18.21	in.
WT.	0.78	lb/ft
θsa	3.80	°C/w/3"

**C 014960**

Per.	28.19	in.
WT.	1.29	lb/ft
θsa	2.50	°C/w/3"

**011890**

Per.	22.01	in.
WT.	1.41	lb/ft
θsa	3.20	°C/w/3"

**012661**

Per.	27.57	in.
WT.	1.33	lb/ft
θsa	2.50	°C/w/3"

**C 016010**

Per.	14.26	in.
WT.	0.71	lb/ft
θsa	5.00	°C/w/3"

**015902**

Per.	47.46	in.
WT.	3.06	lb/ft
θsa	4.10	°C/w/3"

**XX8410**

Per.	24.67	in.
WT.	3.88	lb/ft
θsa	2.10	°C/w/3"

**D 014701**

Per.	40.80	in.
WT.	2.09	lb/ft
θsa	1.70	°C/w/3"

**19803**

Per.	25.89	in.
WT.	1.25	lb/ft
θsa	2.70	°C/w/3"

**013141**

Per.	34.12	in.
WT.	1.33	lb/ft
θsa	2.10	°C/w/3"

**D 016225**

Per.	17.41	in.
WT.	0.85	lb/ft
θsa	7.10	°C/w/3"

**XX8373**

Per.	14.97	in.
WT.	0.76	lb/ft
θsa	6.00	°C/w/3"

**014762**

Per.	15.52	in.
WT.	0.70	lb/ft
θsa	4.50	°C/w/3"

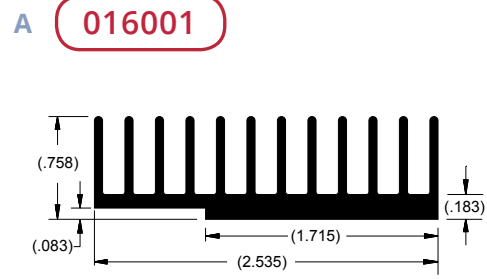

Per.	18.74	in.
WT.	0.97	lb/ft
θsa	4.60	°C/w/3"

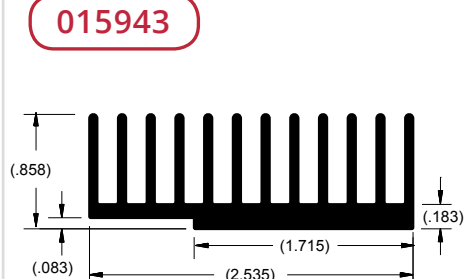

Per.	21.14	in.
WT.	1.14	lb/ft
θsa	4.20	°C/w/3"

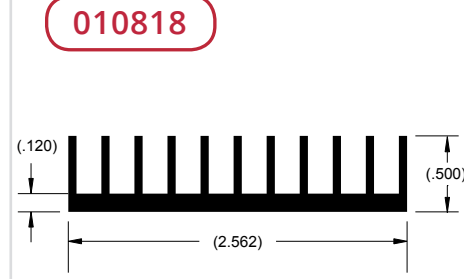

Per.	13.48	in.
WT.	0.68	lb/ft
θsa	5.20	°C/w/3"

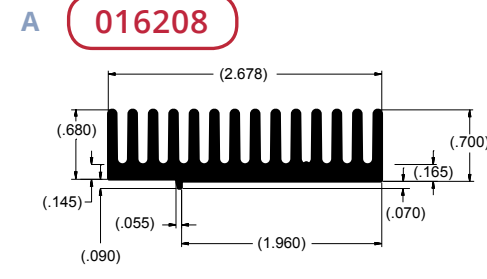

Per.	5.54	in.
WT.	0.03	lb/ft
θsa	5.90	°C/w/3"

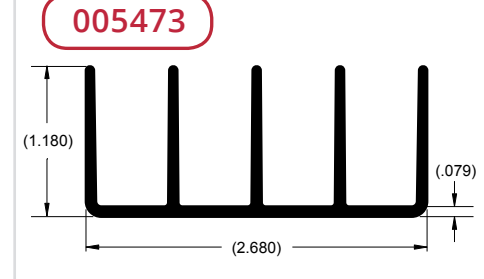

Per.	16.52	in.
WT.	0.70	lb/ft
θsa	4.20	°C/w/3"

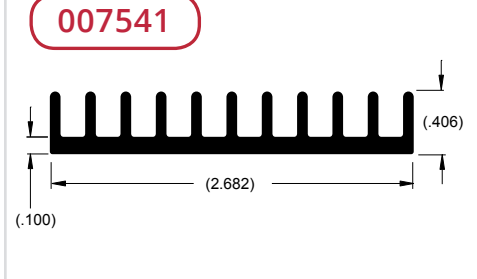

Per.	10.58	in.
WT.	0.50	lb/ft
θsa	6.60	°C/w/3"

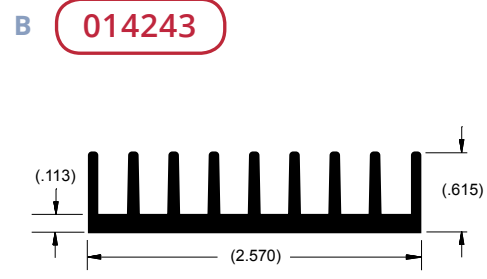

Per.	13.84	in.
WT.	0.76	lb/ft
θsa	5.10	°C/w/3"

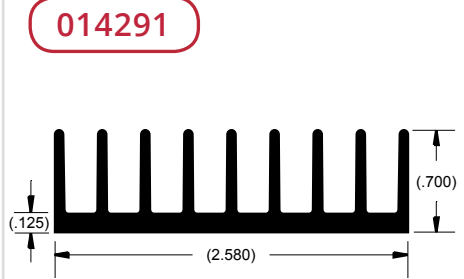

Per.	15.25	in.
WT.	0.79	lb/ft
θsa	4.60	°C/w/3"

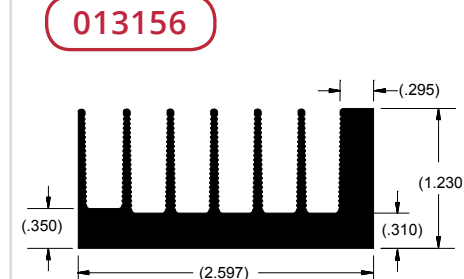

Per.	18.12	in.
WT.	1.74	lb/ft
θsa	3.90	°C/w/3"

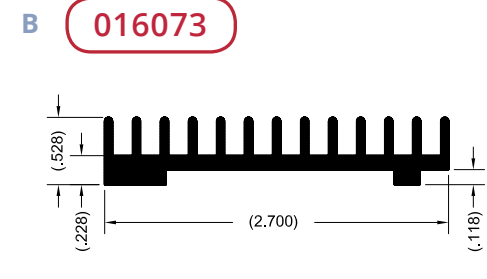

Per.	13.80	in.
WT.	0.71	lb/ft
θsa	5.30	°C/w/3"

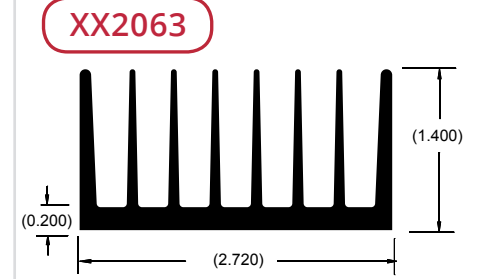

Per.	24.24	in.
WT.	1.65	lb/ft
θsa	1.90	°C/w/3"

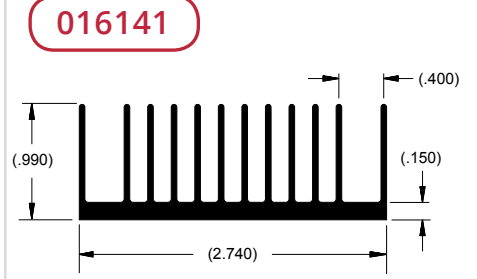

Per.	25.40	in.
WT.	1.10	lb/ft
θsa	3.60	°C/w/3"

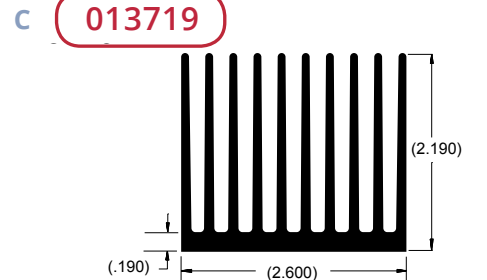

Per.	44.29	in.
WT.	2.58	lb/ft
θsa	1.60	°C/w/3"

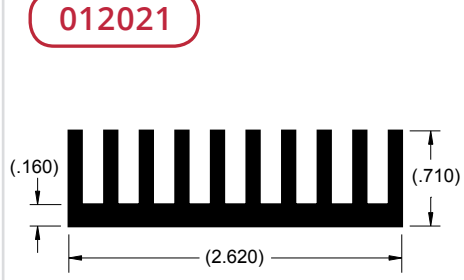

Per.	16.56	in.
WT.	1.16	lb/ft
θsa	4.20	°C/w/3"

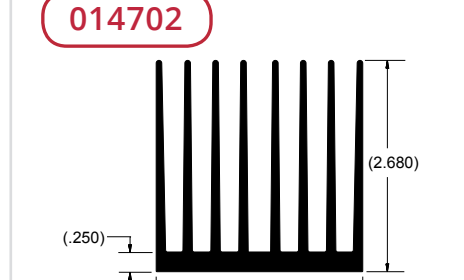

Per.	44.19	in.
WT.	2.91	lb/ft
θsa	1.60	°C/w/3"



Per.	22.07	in.
WT.	1.07	lb/ft
θsa	6.10	°C/w/3"

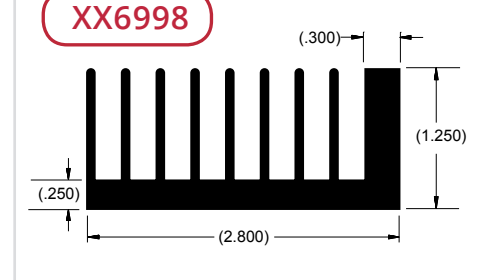

Per.	24.10	in.
WT.	1.80	lb/ft
θsa	2.90	°C/w/3"

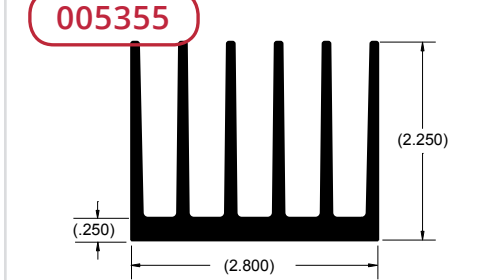

Per.	30.00	in.
WT.	2.33	lb/ft
θsa	2.30	°C/w/3"

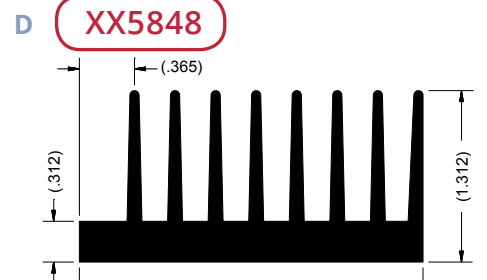

Per.	21.37	in.
WT.	1.63	lb/ft
θsa	3.50	°C/w/3"

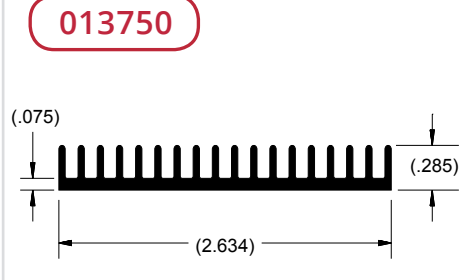

Per.	12.37	in.
WT.	0.47	lb/ft
θsa	5.70	°C/w/3"

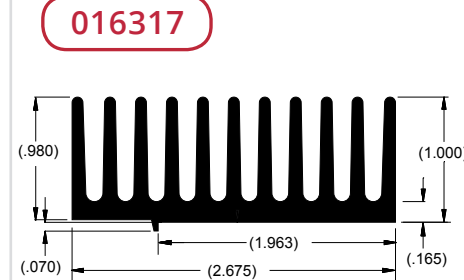

Per.	22.91	in.
WT.	1.67	lb/ft
θsa	3.90	°C/w/3"

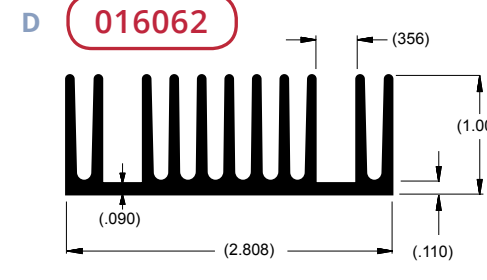

Per.	24.47	in.
WT.	1.20	lb/ft
θsa	3.40	°C/w/3"

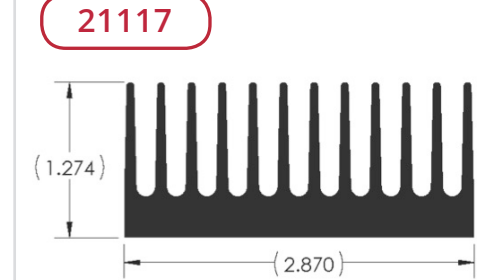

Per.	27.36	in.
WT.	2.32	lb/ft
θsa	2.56	°C/w/3"

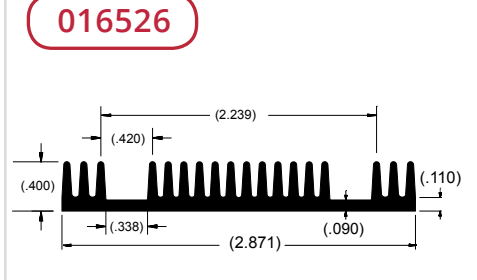

Per.	15.24	in.
WT.	0.77	lb/ft
θsa	7.00	°C/w/3"



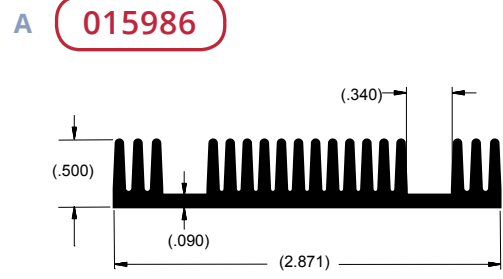

Per.	18.85	in.
WT.	0.88	lb/ft
θsa	6.30	°C/w/3"

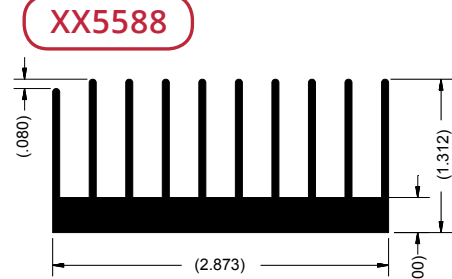

Per.	25.86	in.
WT.	1.81	lb/ft
θsa	2.80	°C/w/3"

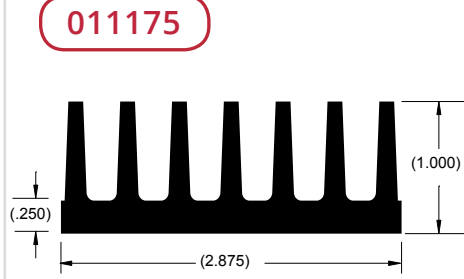

Per.	16.33	in.
WT.	1.86	lb/ft
θsa	4.30	°C/w/3"

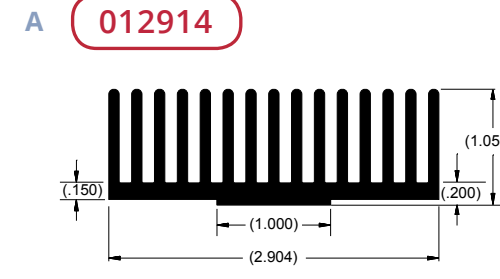

Per.	30.94	in.
WT.	1.86	lb/ft
θsa	2.30	°C/w/3"

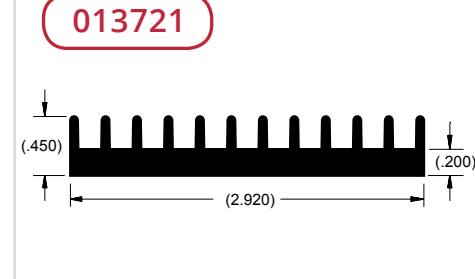

Per.	11.76	in.
WT.	0.91	lb/ft
θsa	6.00	°C/w/3"

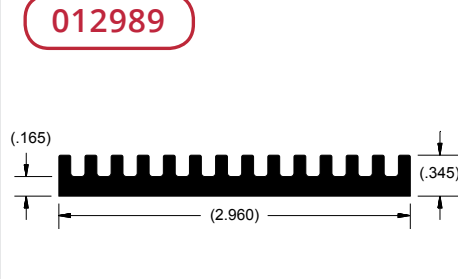

Per.	10.74	in.
WT.	0.89	lb/ft
θsa	6.50	°C/w/3"

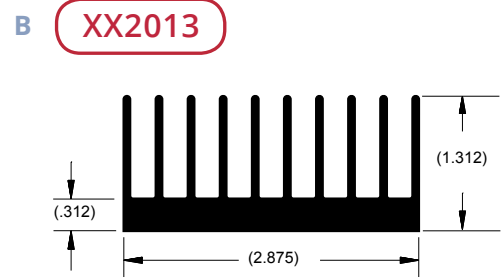

Per.	25.66	in.
WT.	1.76	lb/ft
θsa	2.30	°C/w/3"

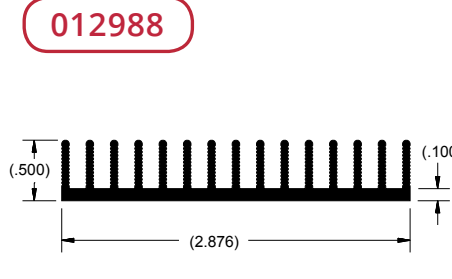

Per.	20.13	in.
WT.	0.72	lb/ft
θsa	3.50	°C/w/3"

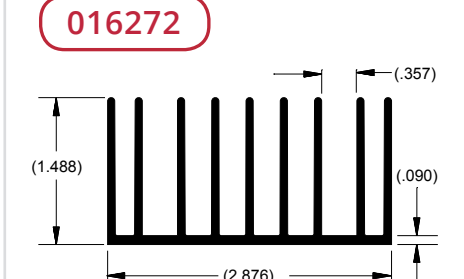

Per.	30.65	in.
WT.	1.44	lb/ft
θsa	2.60	°C/w/3"

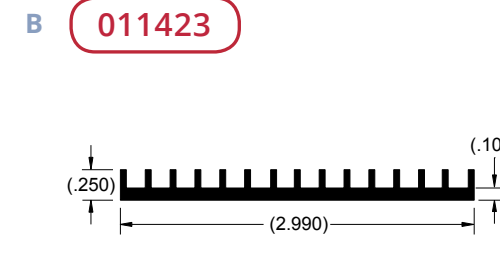

Per.	10.56	in.
WT.	0.48	lb/ft
θsa	6.60	°C/w/3"

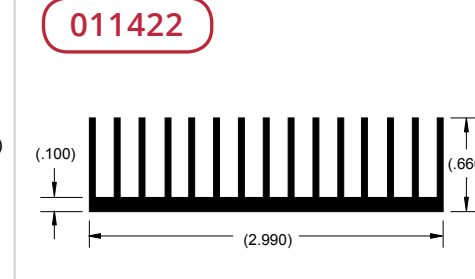

Per.	22.86	in.
WT.	0.84	lb/ft
θsa	3.10	°C/w/3"

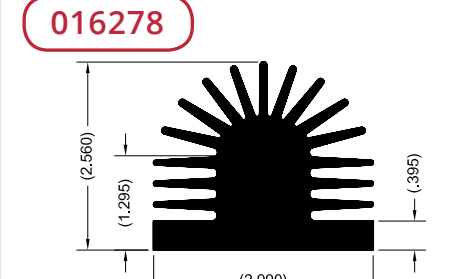

Per.	31.34	in.
WT.	4.84	lb/ft
θsa	2.30	°C/w/3"

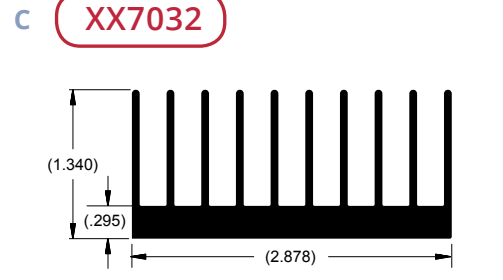

Per.	28.41	in.
WT.	1.91	lb/ft
θsa	2.80	°C/w/3"



Per.	48.21	in.
WT.	1.23	lb/ft
θsa	5.80	°C/w/3"

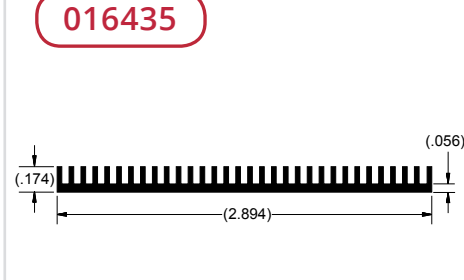

Per.	13.45	in.
WT.	0.36	lb/ft
θsa	12.10	°C/w/3"

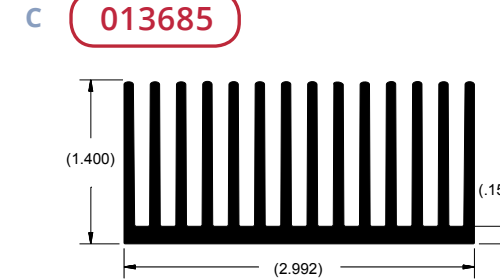

Per.	40.47	in.
WT.	2.32	lb/ft
θsa	1.70	°C/w/3"



Per.	33.84	in.
WT.	1.80	lb/ft
θsa	2.10	°C/w/3"

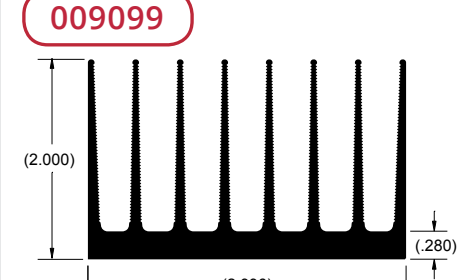

Per.	45.93	in.
WT.	2.56	lb/ft
θsa	1.50	°C/w/3"

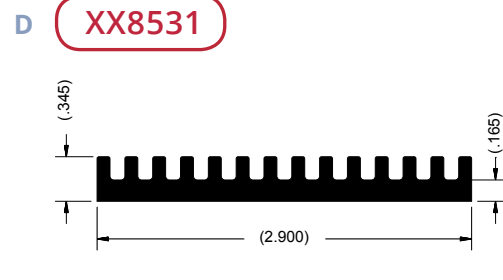

Per.	10.70	in.
WT.	0.83	lb/ft
θsa	8.50	°C/w/3"

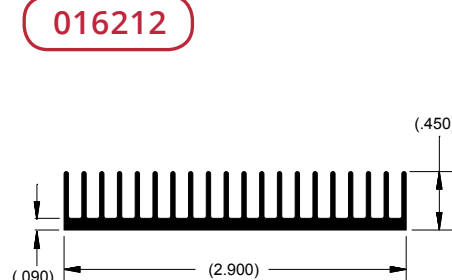

Per.	19.78	in.
WT.	0.63	lb/ft
θsa	5.60	°C/w/3"

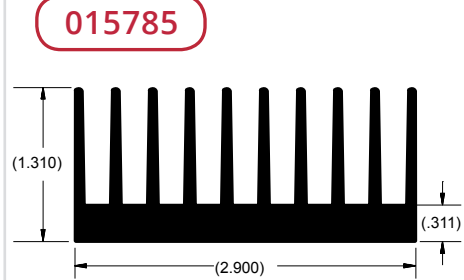

Per.	26.14	in.
WT.	1.82	lb/ft
θsa	3.10	°C/w/3"

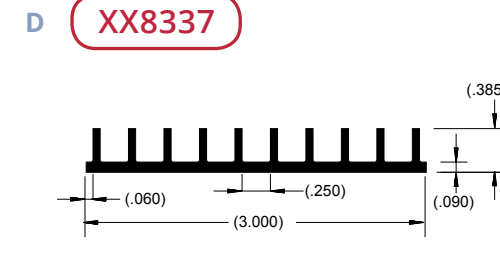

Per.	11.70	in.
WT.	0.51	lb/ft
θsa	5.50	°C/w/3"

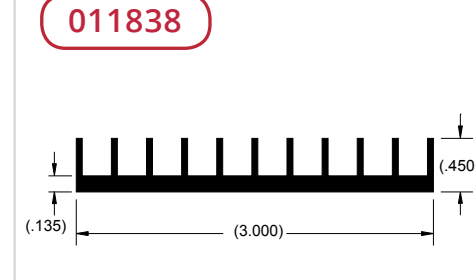

Per.	13.11	in.
WT.	0.67	lb/ft
θsa	5.30	°C/w/3"

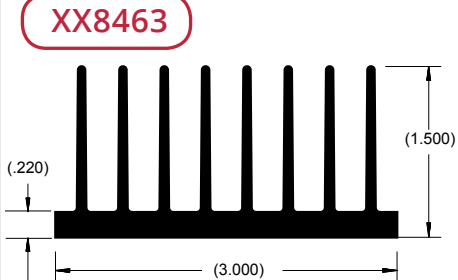

Per.	26.30	in.
WT.	1.54	lb/ft
θsa	2.80	°C/w/3"

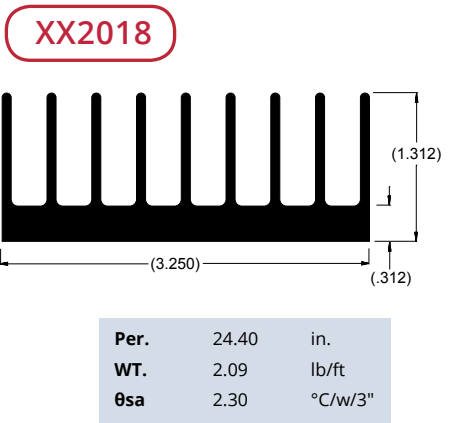
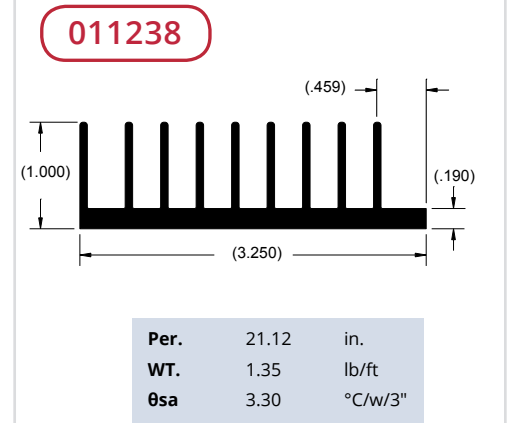
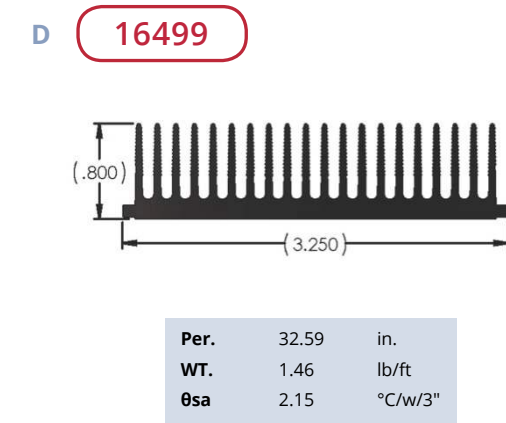
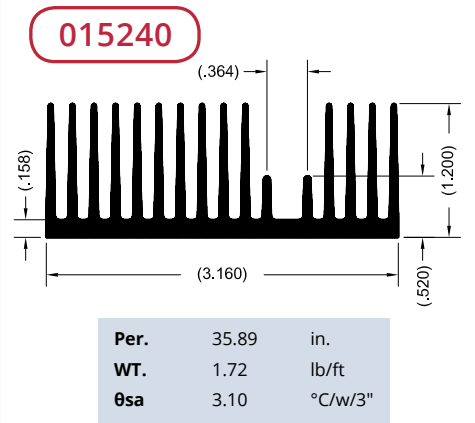
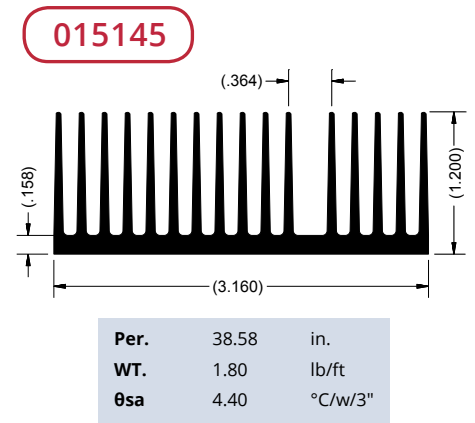
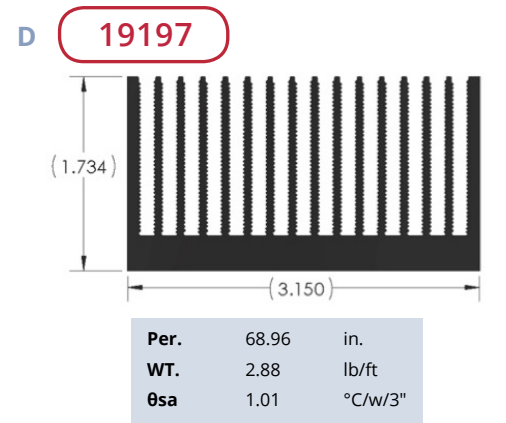
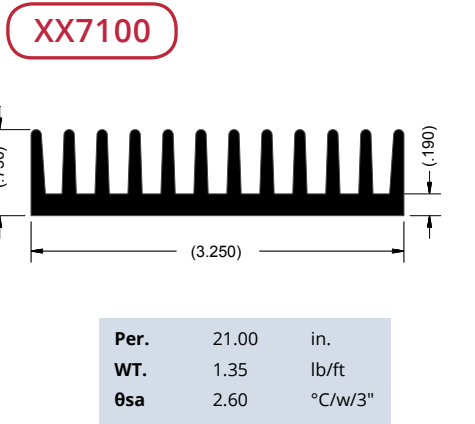
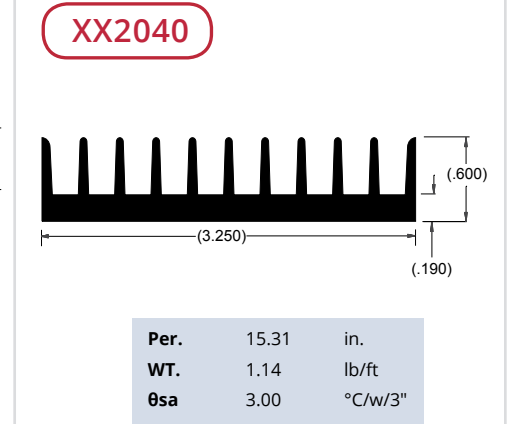
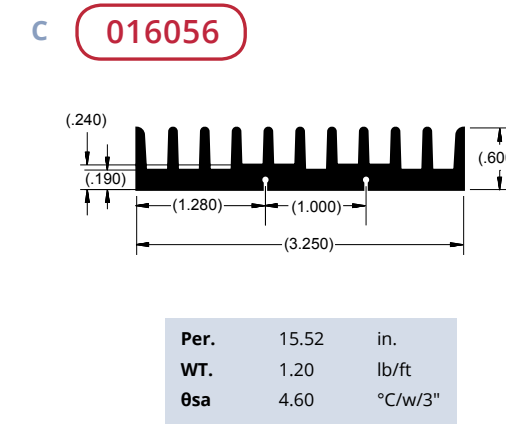
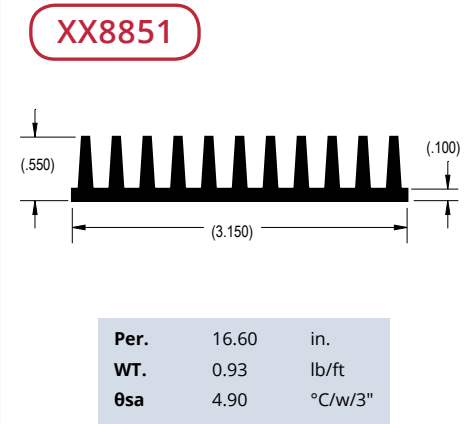
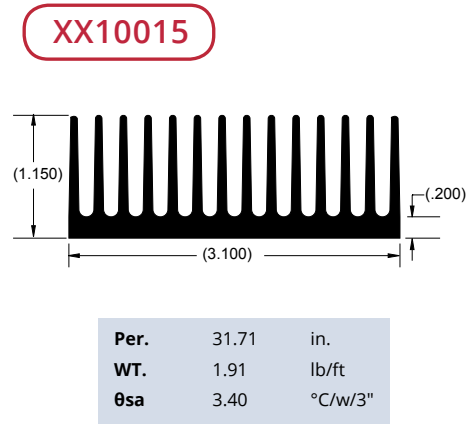
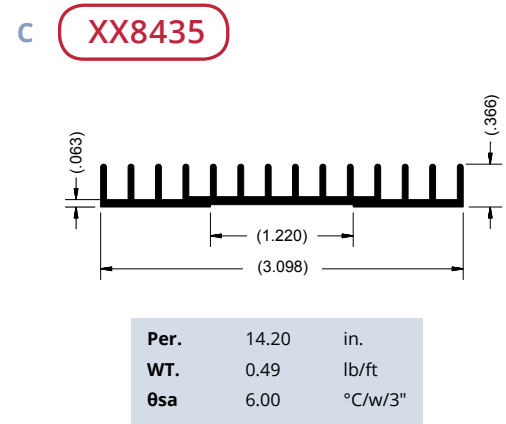
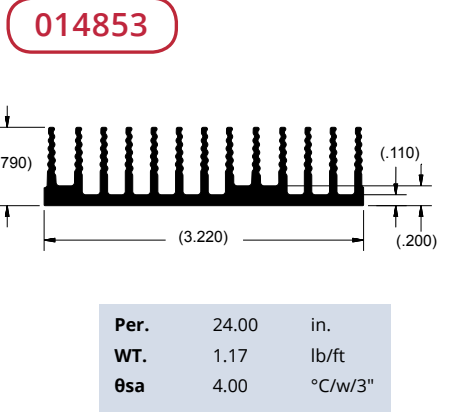
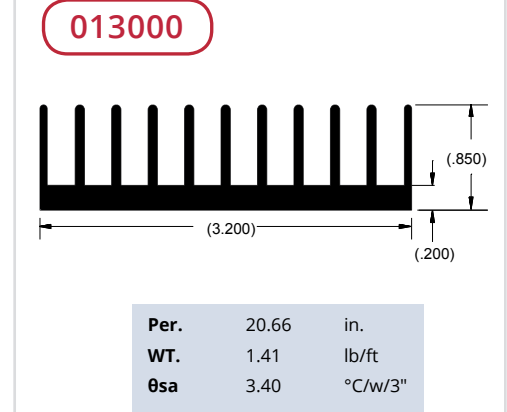
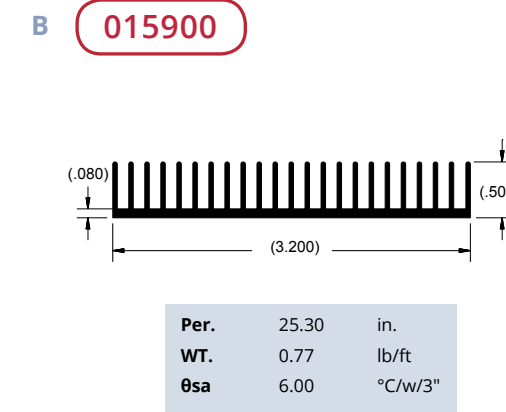
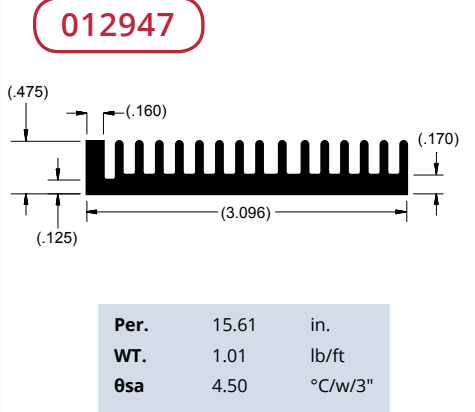
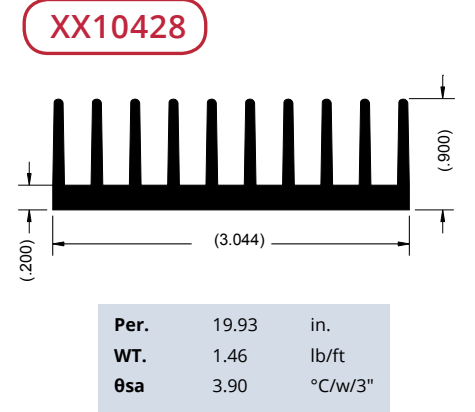
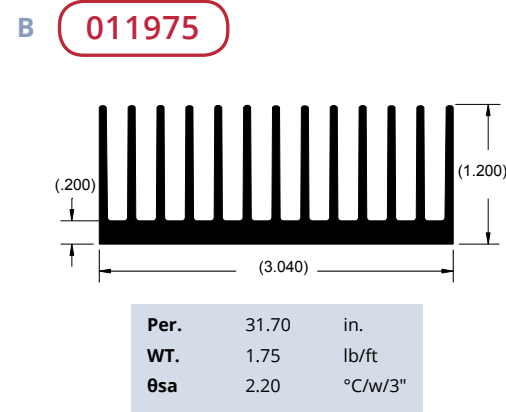
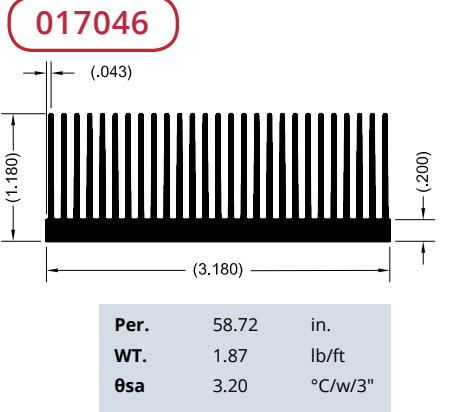
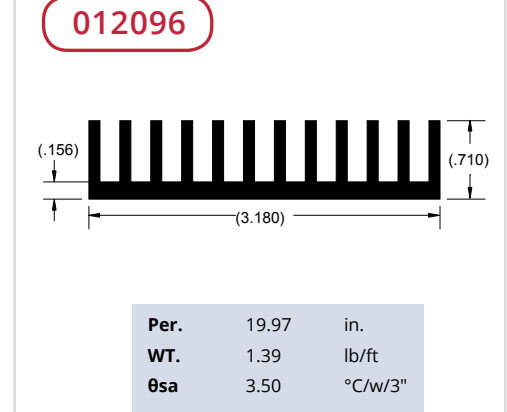
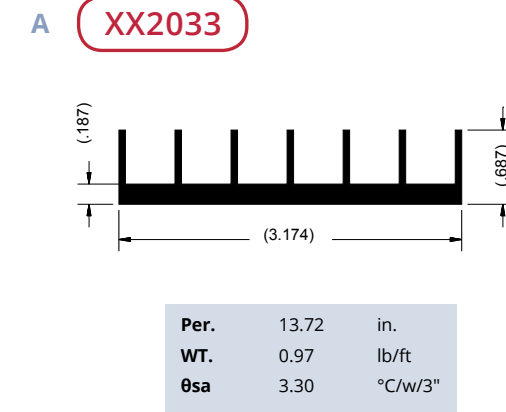
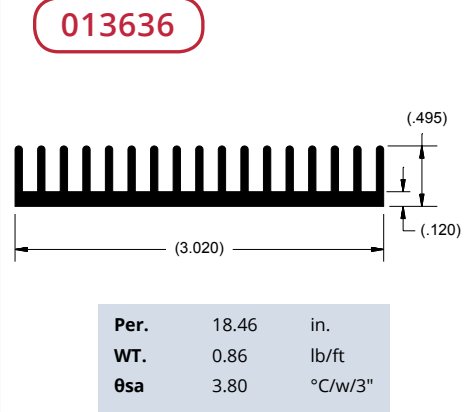
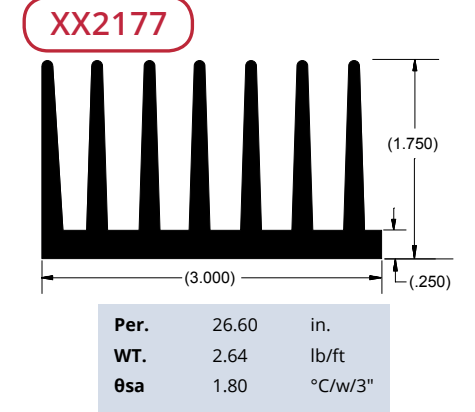
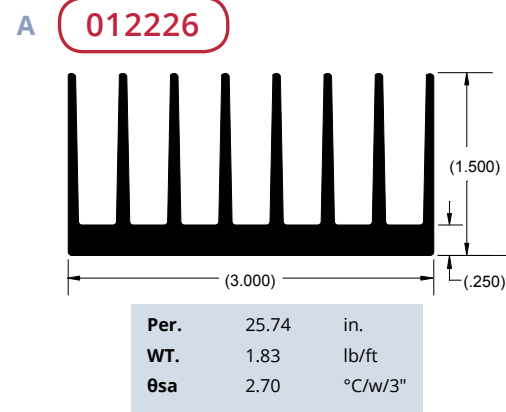

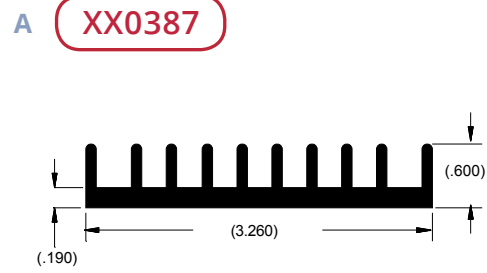

Per.	15.10	in.
WT.	1.23	lb/ft
θsa	4.40	°C/w/3"

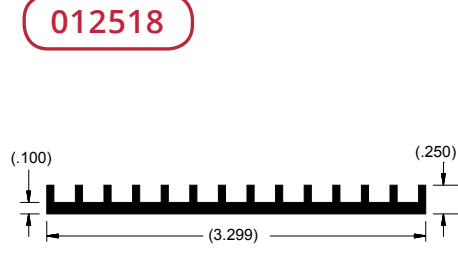

Per.	10.89	in.
WT.	0.54	lb/ft
θsa	6.40	°C/w/3"

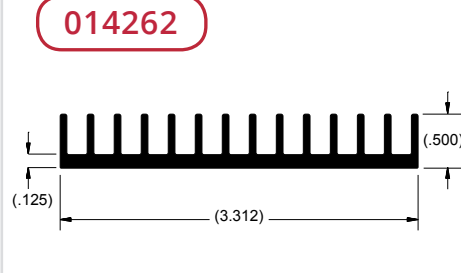

Per.	16.94	in.
WT.	0.88	lb/ft
θsa	4.10	°C/w/3"

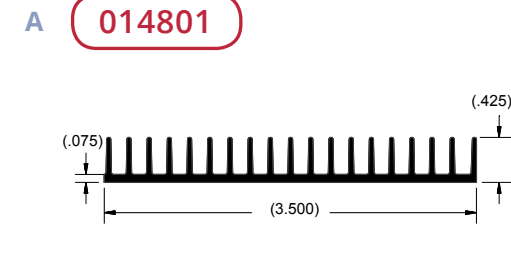

Per.	19.65	in.
WT.	0.67	lb/ft
θsa	5.30	°C/w/3"

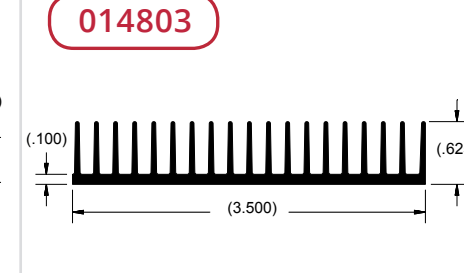

Per.	26.23	in.
WT.	0.98	lb/ft
θsa	4.50	°C/w/3"

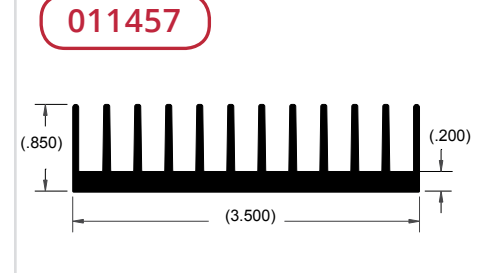

Per.	22.48	in.
WT.	1.48	lb/ft
θsa	3.00	°C/w/3"

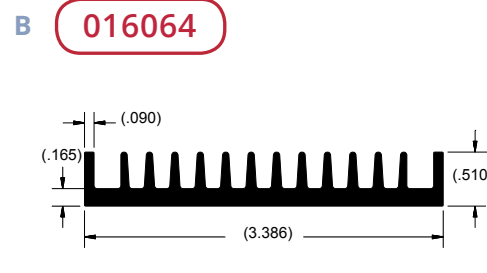

Per.	15.71	in.
WT.	1.13	lb/ft
θsa	5.20	°C/w/3"

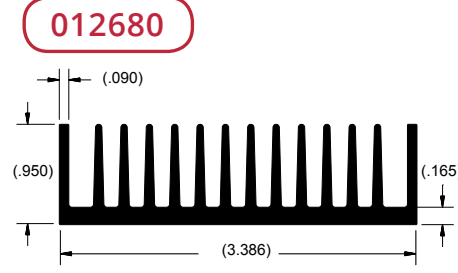

Per.	27.96	in.
WT.	1.74	lb/ft
θsa	2.50	°C/w/3"

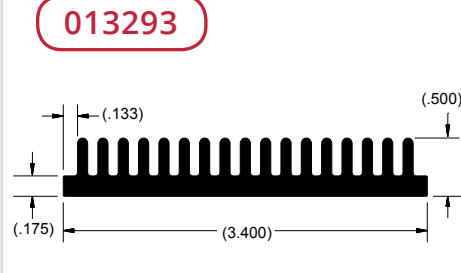

Per.	17.07	in.
WT.	1.29	lb/ft
θsa	4.10	°C/w/3"

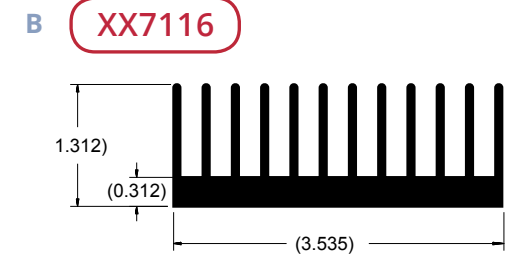

Per.	31.33	in.
WT.	2.32	lb/ft
θsa	2.40	°C/w/3"

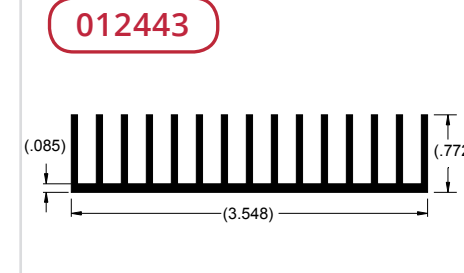

Per.	27.76	in.
WT.	1.10	lb/ft
θsa	2.50	°C/w/3"

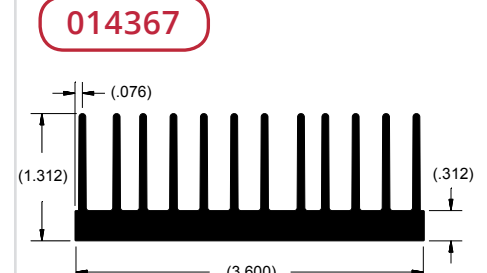

Per.	31.04	in.
WT.	2.42	lb/ft
θsa	2.30	°C/w/3"



Per.	47.29	in.
WT.	2.33	lb/ft
θsa	4.90	°C/w/3"

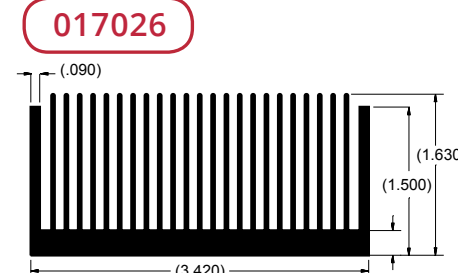

Per.	75.51	in.
WT.	2.47	lb/ft
θsa	5.40	°C/w/3"

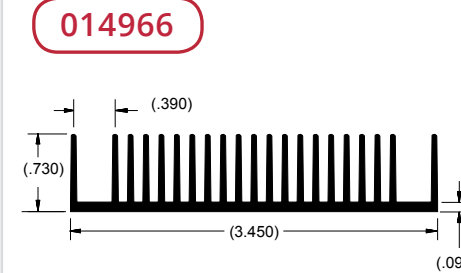

Per.	33.25	in.
WT.	1.22	lb/ft
θsa	4.80	°C/w/3"

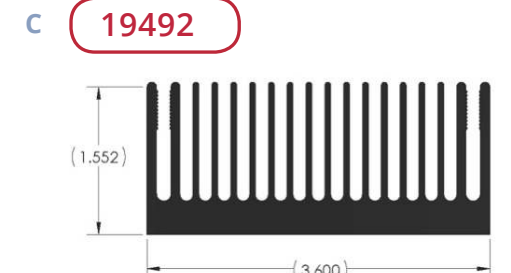

Per.	51.76	in.
WT.	3.39	lb/ft
θsa	1.35	°C/w/3"

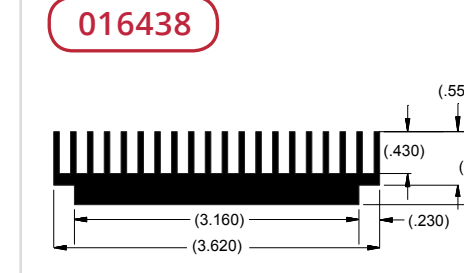

Per.	25.08	in.
WT.	1.92	lb/ft
θsa	4.20	°C/w/3"

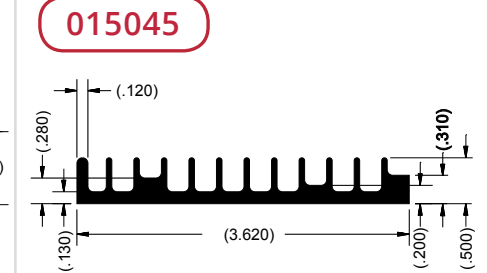

Per.	15.01	in.
WT.	1.04	lb/ft
θsa	4.90	°C/w/3"

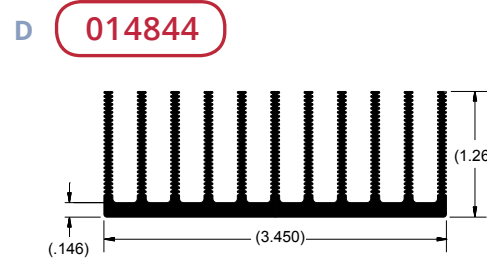

Per.	44.42	in.
WT.	1.62	lb/ft
θsa	1.60	°C/w/3"

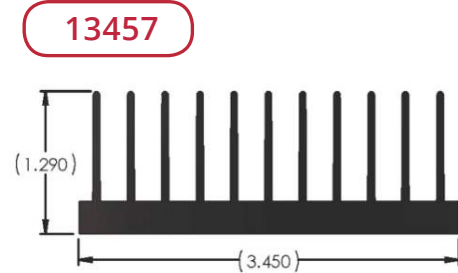

Per.	28.99	in.
WT.	2.07	lb/ft
θsa	2.41	°C/w/3"

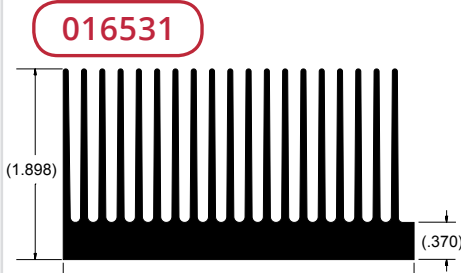

Per.	64.12	in.
WT.	3.67	lb/ft
θsa	2.60	°C/w/3"

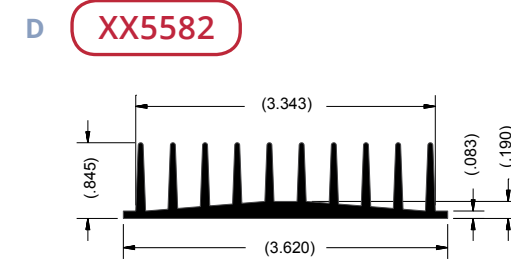

Per.	20.71	in.
WT.	1.26	lb/ft
θsa	2.80	°C/w/3"

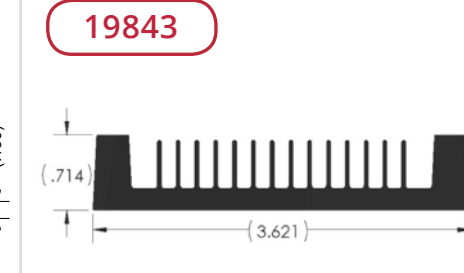

Per.	21.58	in.
WT.	1.67	lb/ft
θsa	3.24	°C/w/3"

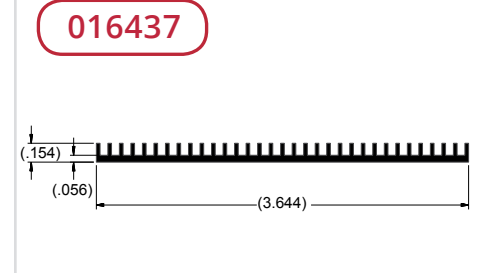

Per.	13.87	in.
WT.	0.38	lb/ft
θsa	12.00	°C/w/3"

Not all stocked. Example shapes are not all tooled.



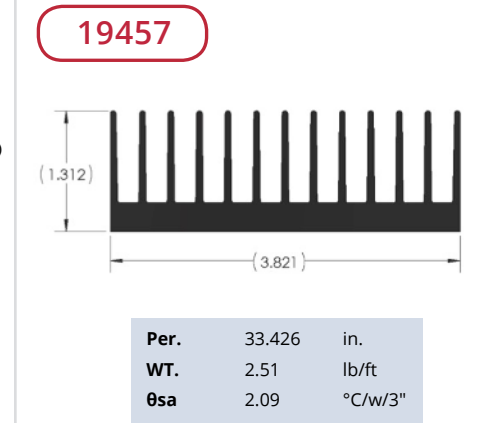
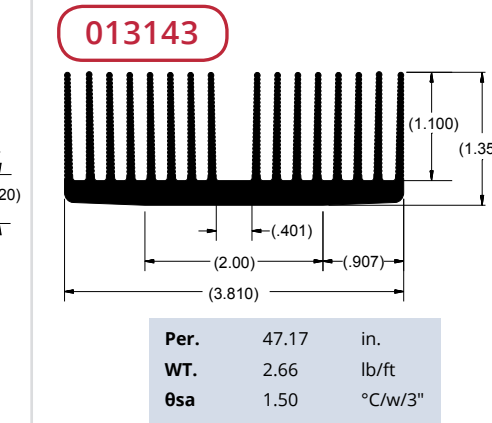
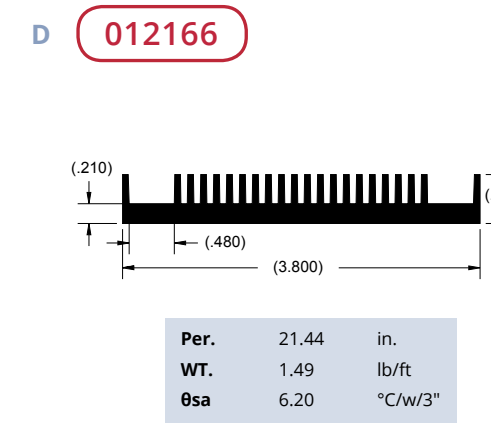
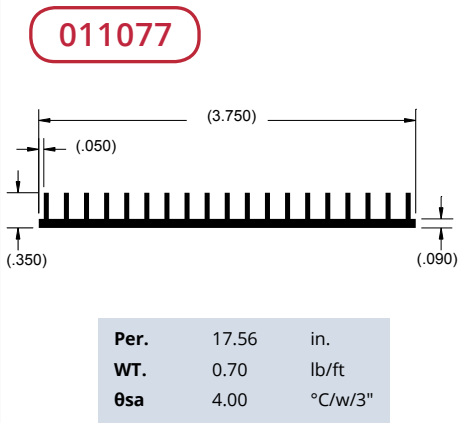
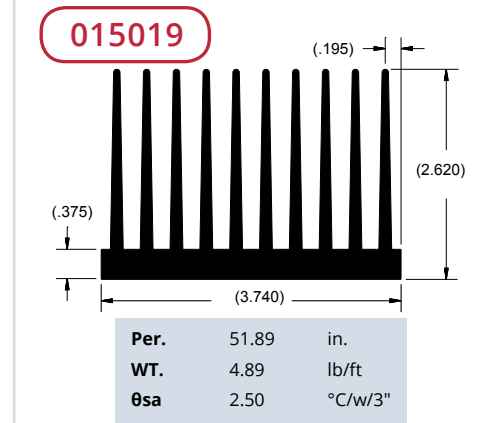
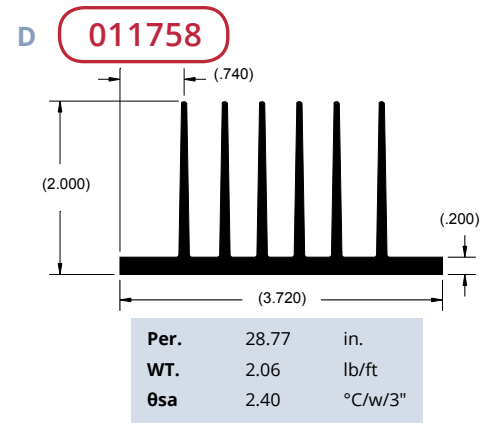
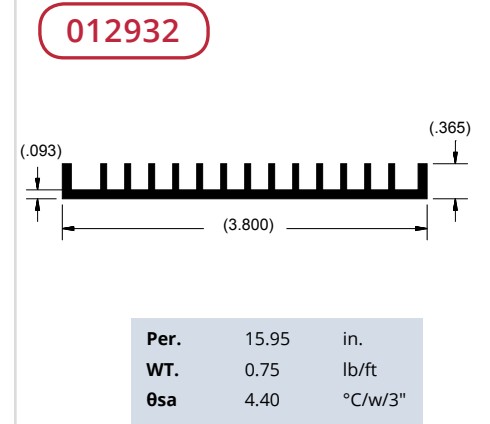
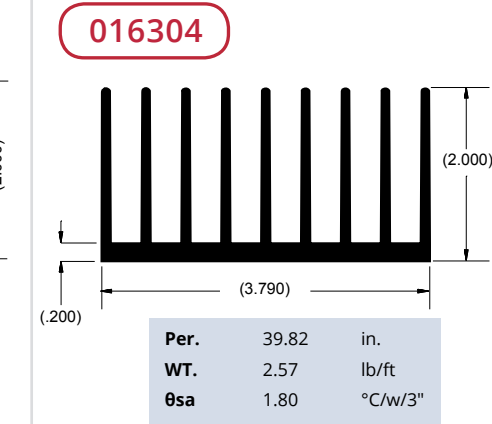
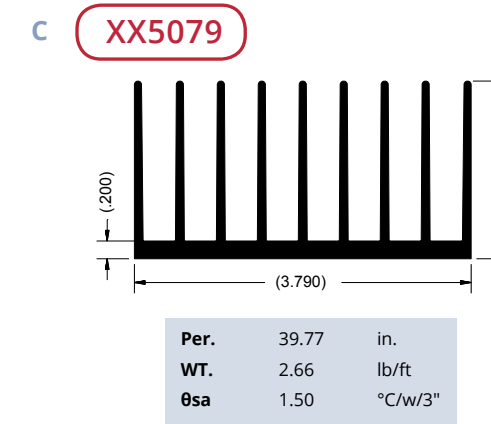
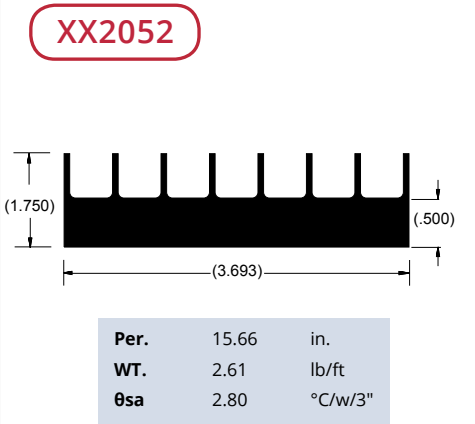
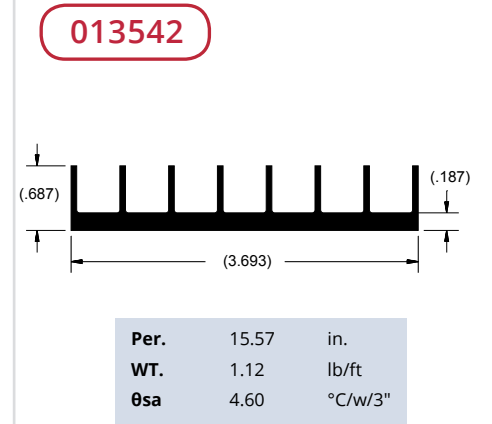
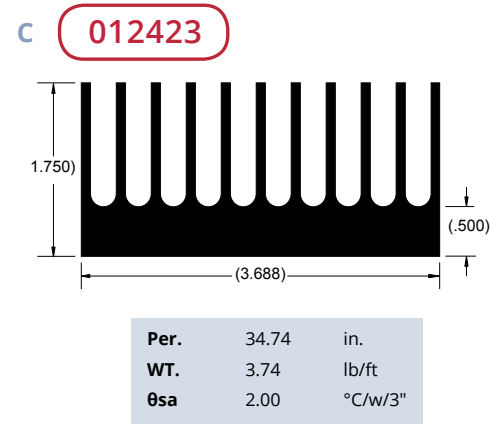
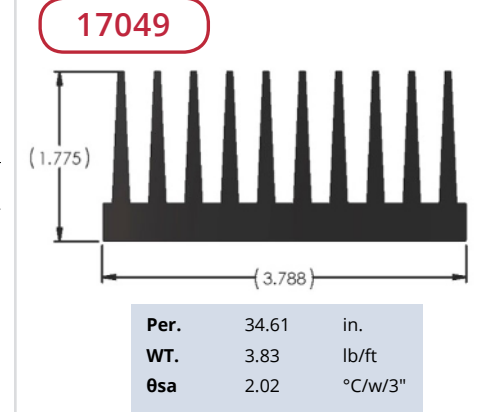
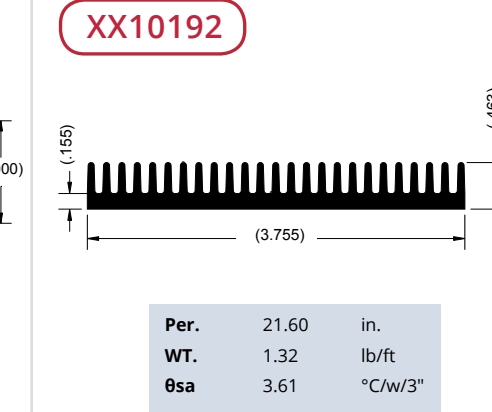
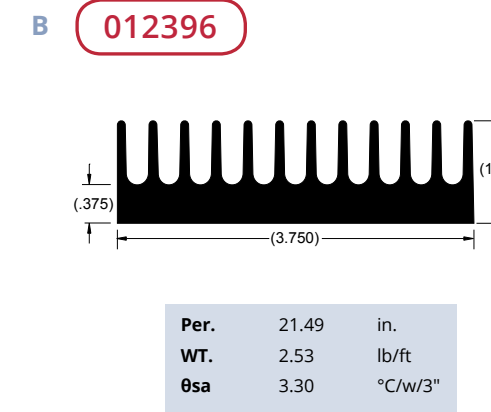
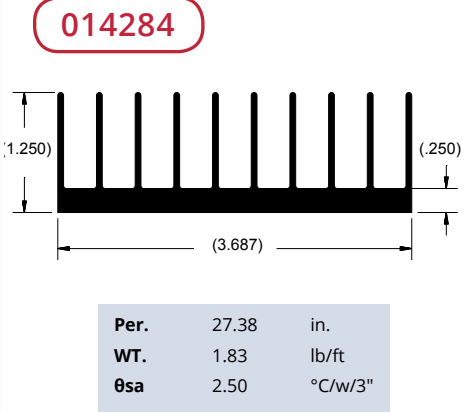
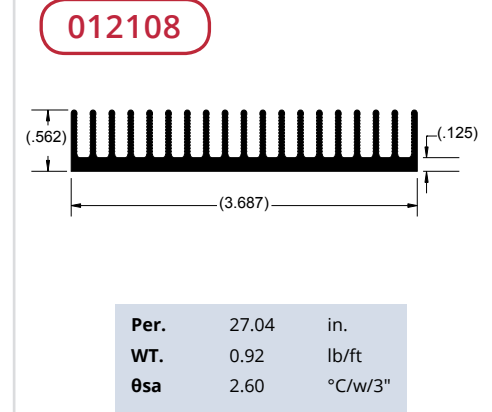
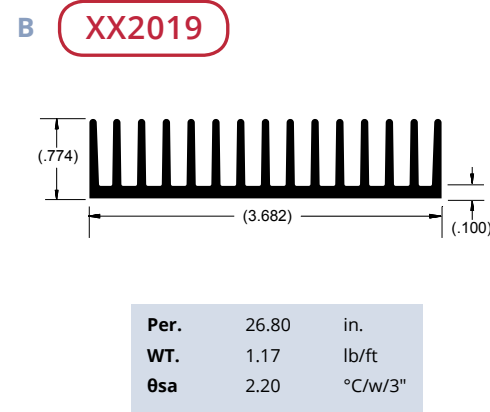
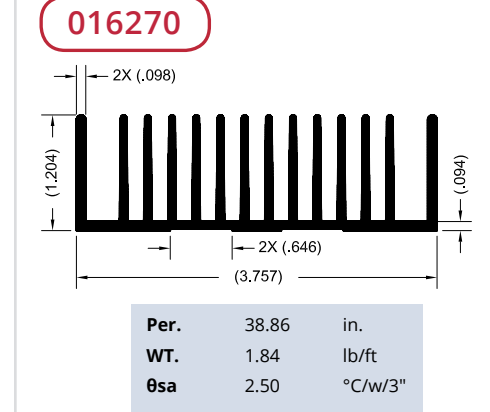
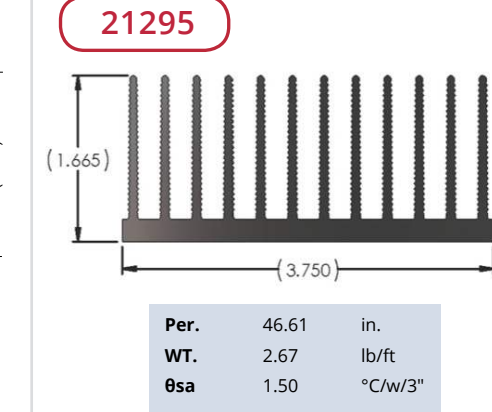
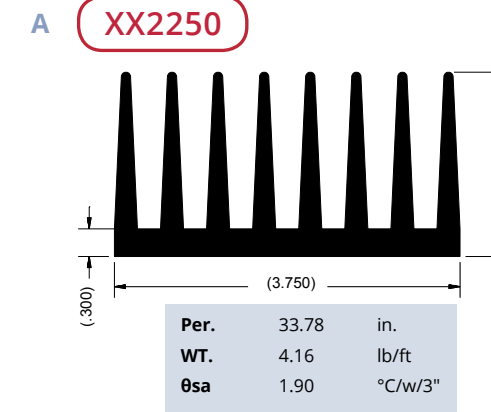
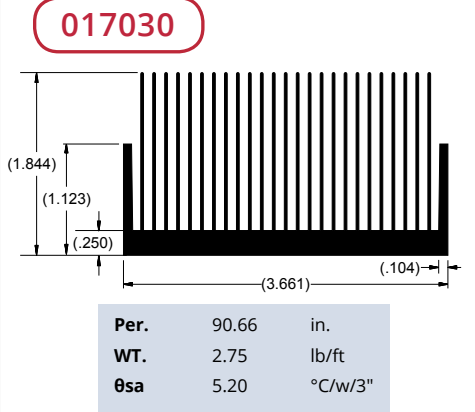
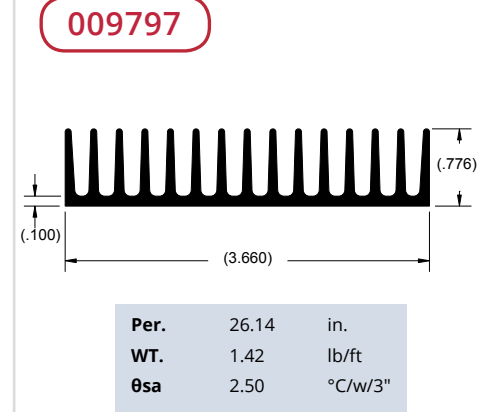
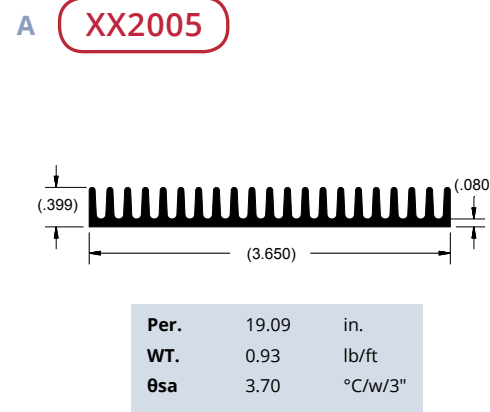

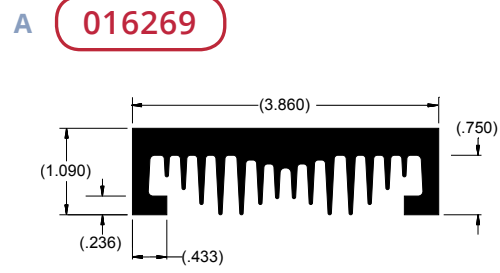

Per.	25.82	in.
WT.	2.93	lb/ft
θsa	3.30	°C/w/3"

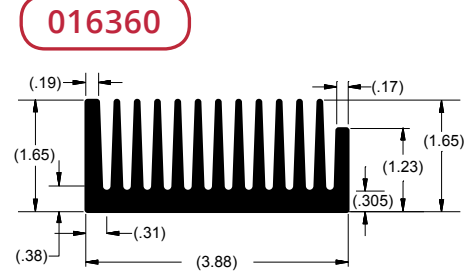

Per.	40.33	in.
WT.	3.89	lb/ft
θsa	2.90	°C/w/3"

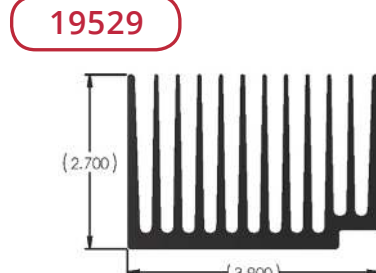

Per.	63.88	in.
WT.	4.66	lb/ft
θsa	1.09	°C/w/3"

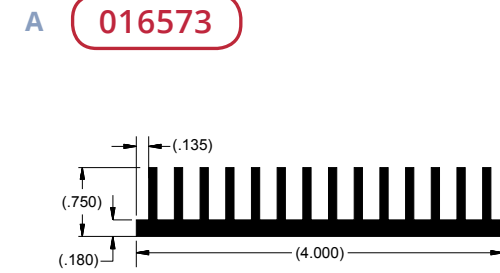

Per.	24.32	in.
WT.	1.73	lb/ft
θsa	3.70	°C/w/3"

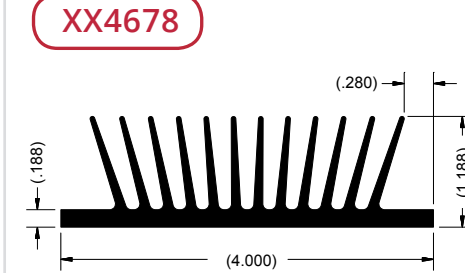

Per.	32.90	in.
WT.	1.93	lb/ft
θsa	2.30	°C/w/3"

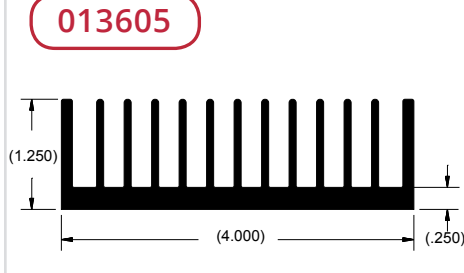

Per.	33.87	in.
WT.	2.55	lb/ft
θsa	2.10	°C/w/3"



Per.	51.63	in.
WT.	2.81	lb/ft
θsa	2.30	°C/w/3"

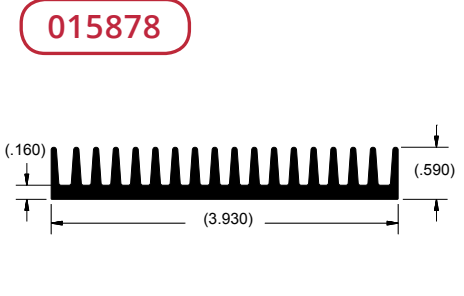

Per.	21.95	in.
WT.	1.54	lb/ft
θsa	9.70	°C/w/3"

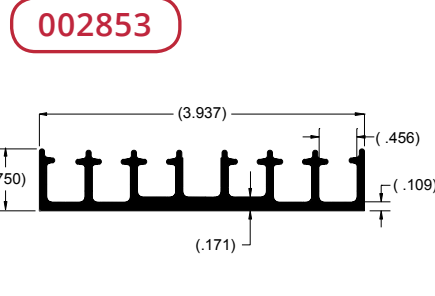

Per.	22.00	in.
WT.	1.20	lb/ft
θsa	3.20	°C/w/3"

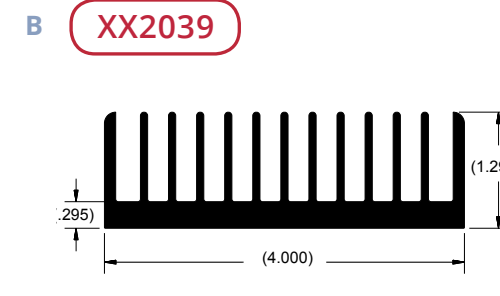

Per.	33.66	in.
WT.	2.75	lb/ft
θsa	1.90	°C/w/3"

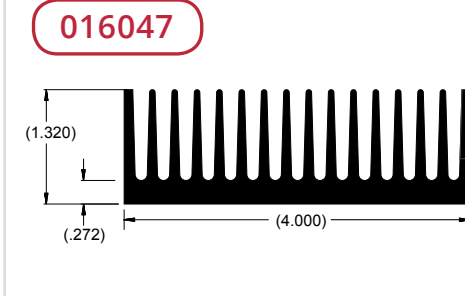

Per.	40.03	in.
WT.	3.15	lb/ft
θsa	2.70	°C/w/3"

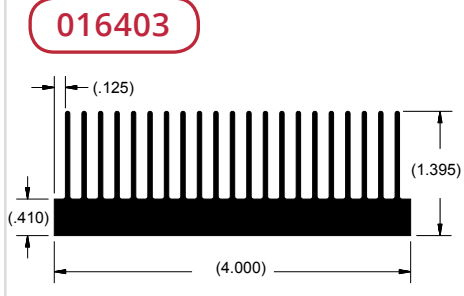

Per.	49.20	in.
WT.	3.21	lb/ft
θsa	3.40	°C/w/3"

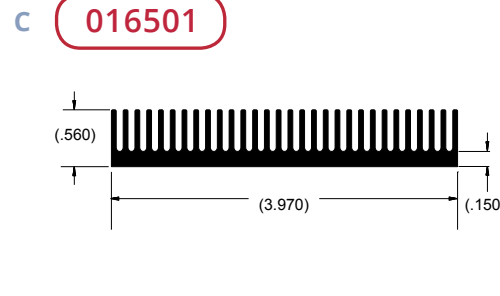

Per.	31.46	in.
WT.	1.55	lb/ft
θsa	6.10	°C/w/3"

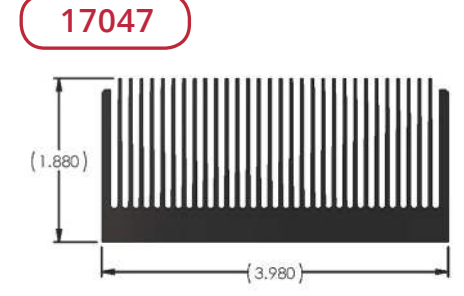

Per.	102.27	in.
WT.	4.33	lb/ft
θsa	0.68	°C/w/3"

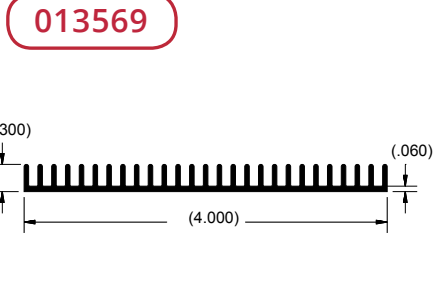

Per.	20.17	in.
WT.	0.67	lb/ft
θsa	7.20	°C/w/3"

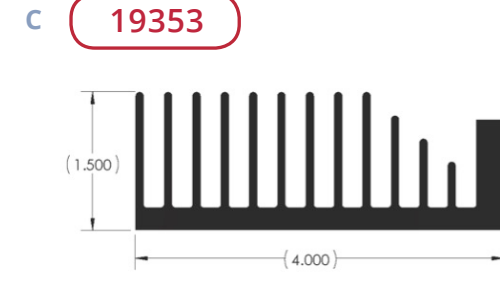

Per.	36.60	in.
WT.	2.99	lb/ft
θsa	1.91	°C/w/3"

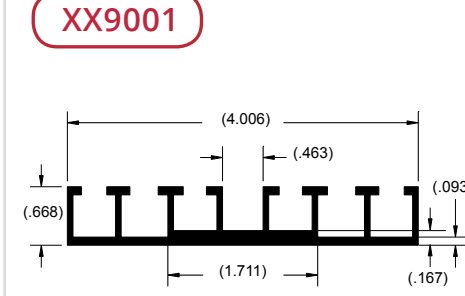

Per.	19.51	in.
WT.	1.08	lb/ft
θsa	2.40	°C/w/3"

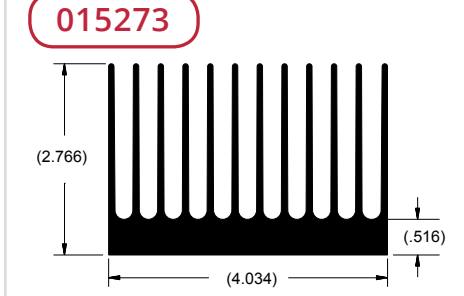

Per.	61.28	in.
WT.	5.37	lb/ft
θsa	1.80	°C/w/3"

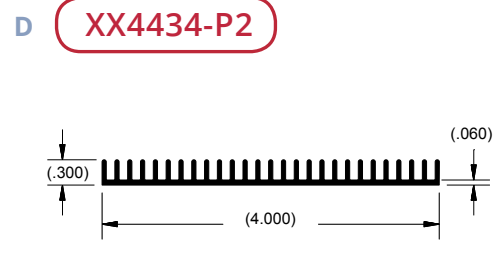

Per.	20.16	in.
WT.	0.67	lb/ft
θsa	2.70	°C/w/3"

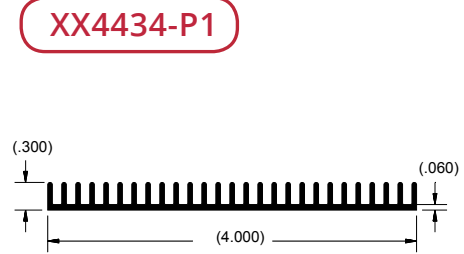

Per.	16.22	in.
WT.	0.55	lb/ft
θsa	3.00	°C/w/3"

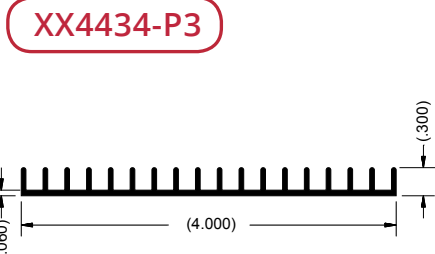

Per.	23.96	in.
WT.	0.76	lb/ft
θsa	7.00	°C/w/3"

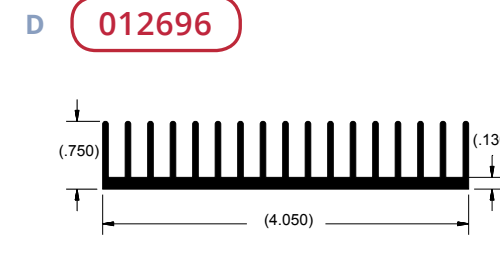

Per.	28.99	in.
WT.	1.41	lb/ft
θsa	2.40	°C/w/3"

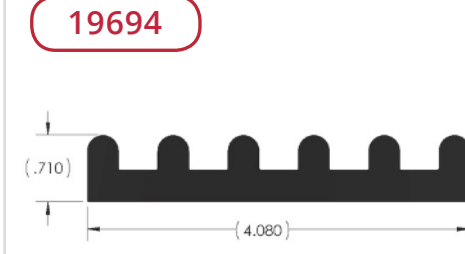

Per.	12.34	in.
WT.	2.50	lb/ft
θsa	5.66	°C/w/3"

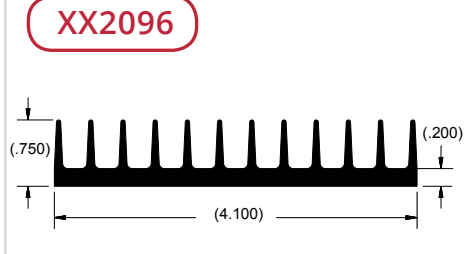

Per.	20.48	in.
WT.	1.56	lb/ft
θsa	2.50	°C/w/3"

**A 011299**

Per.	36.66	in.
WT.	3.41	lb/ft
θsa	1.90	°C/w/3"

**008658**

Per.	42.61	in.
WT.	2.41	lb/ft
θsa	2.20	°C/w/3"

**XX2012**

Per.	35.79	in.
WT.	3.30	lb/ft
θsa	2.00	°C/w/3"

**A 012677**

Per.	42.21	in.
WT.	3.16	lb/ft
θsa	1.70	°C/w/3"

**XX2004**

Per.	31.70	in.
WT.	2.75	lb/ft
θsa	2.20	°C/w/3"

**014793**

Per.	34.36	in.
WT.	1.78	lb/ft
θsa	4.30	°C/w/3"

**B XX5138**

Per.	37.30	in.
WT.	3.53	lb/ft
θsa	1.90	°C/w/3"

**009396**

Per.	31.61	in.
WT.	2.07	lb/ft
θsa	2.10	°C/w/3"

**010785**

Per.	21.17	in.
WT.	1.80	lb/ft
θsa	3.20	°C/w/3"

**B 015936**

Per.	21.39	in.
WT.	1.47	lb/ft
θsa	4.50	°C/w/3"

**013729**

Per.	49.27	in.
WT.	3.13	lb/ft
θsa	1.40	°C/w/3"

**016003**

Per.	18.90	in.
WT.	0.95	lb/ft
θsa	6.10	°C/w/3"

**C 013733**

Per.	41.06	in.
WT.	2.16	lb/ft
θsa	1.70	°C/w/3"

**016423**

Per.	38.35	in.
WT.	1.72	lb/ft
θsa	2.90	°C/w/3"

**014813**

Per.	50.61	in.
WT.	2.46	lb/ft
θsa	1.40	°C/w/3"

**C 015945**

Per.	22.40	in.
WT.	1.09	lb/ft
θsa	5.80	°C/w/3"

**015172**

Per.	28.44	in.
WT.	1.48	lb/ft
θsa	4.20	°C/w/3"

**XX1527**

Per.	36.45	in.
WT.	2.58	lb/ft
θsa	1.40	°C/w/3"

**D 016192**

Per.	45.16	in.
WT.	1.88	lb/ft
θsa	3.60	°C/w/3"

**016232**

Per.	50.70	in.
WT.	2.49	lb/ft
θsa	3.70	°C/w/3"

**009168**

Per.	59.90	in.
WT.	3.30	lb/ft
θsa	3.50	°C/w/3"

**D 013564**

Per.	25.37	in.
WT.	1.74	lb/ft
θsa	2.80	°C/w/3"

**19249**

Per.	60.91	in.
WT.	5.27	lb/ft
θsa	1.15	°C/w/3"

**XX10253**

Per.	58.56	in.
WT.	5.24	lb/ft
θsa	1.36	°C/w/3"

**A 17080**

Per.	118.88	in.
WT.	6.34	lb/ft
θsa	0.59	°C/w/3"

**012397**

Per.	18.60	in.
WT.	1.52	lb/ft
θsa	3.80	°C/w/3"

**XX2050**

Per.	38.94	in.
WT.	3.32	lb/ft
θsa	2.20	°C/w/3"

**A 013096**

Per.	16.43	in.
WT.	0.97	lb/ft
θsa	4.30	°C/w/3"

**013099**

Per.	22.70	in.
WT.	1.20	lb/ft
θsa	3.10	°C/w/3"

**012894**

Per.	44.20	in.
WT.	2.13	lb/ft
θsa	1.60	°C/w/3"

**B 017033**

Per.	69.28	in.
WT.	3.57	lb/ft
θsa	3.60	°C/w/3"

**012749**

Per.	36.08	in.
WT.	3.14	lb/ft
θsa	1.90	°C/w/3"

**19787**

Per.	61.33	in.
WT.	2.97	lb/ft
θsa	1.14	°C/w/3"

**B 016321**

Per.	106.91	in.
WT.	6.57	lb/ft
θsa	3.40	°C/w/3"

**015712**

Per.	149.60	in.
WT.	9.13	lb/ft
θsa	2.90	°C/w/3"

**003676**

Per.	32.39	in.
WT.	1.56	lb/ft
θsa	2.20	°C/w/3"

**C 010998**

Per.	26.42	in.
WT.	1.78	lb/ft
θsa	2.60	°C/w/3"

**XX4652**

Per.	40.32	in.
WT.	2.37	lb/ft
θsa	1.80	°C/w/3"

**015174**

Per.	57.50	in.
WT.	4.19	lb/ft
θsa	1.20	°C/w/3"

**C 007657**

Per.	24.83	in.
WT.	1.27	lb/ft
θsa	3.40	°C/w/3"

**XX3286**

Per.	24.92	in.
WT.	1.28	lb/ft
θsa	2.40	°C/w/3"

**012987**

Per.	45.36	in.
WT.	3.07	lb/ft
θsa	1.50	°C/w/3"

**D XX0233**

Per.	36.00	in.
WT.	3.15	lb/ft
θsa	1.90	°C/w/3"

**19409**

Per.	47.335	in.
WT.	3.37	lb/ft
θsa	1.48	°C/w/3"

**013756**

Per.	42.33	in.
WT.	2.61	lb/ft
θsa	1.70	°C/w/3"

**D 015862**

Per.	65.91	in.
WT.	2.55	lb/ft
θsa	1.80	°C/w/3"

**011944**

Per.	19.85	in.
WT.	1.16	lb/ft
θsa	3.90	°C/w/3"

**014770**

Per.	22.28	in.
WT.	1.18	lb/ft
θsa	6.20	°C/w/3"



**A 013618**

Per.	17.69	in.
WT.	1.14	lb/ft
θsa	4.00	°C/w/3"

**013716**

Per.	31.72	in.
WT.	1.54	lb/ft
θsa	2.20	°C/w/3"

**012823**

Per.	27.45	in.
WT.	1.40	lb/ft
θsa	2.50	°C/w/3"

**A 014320**

Per.	33.46	in.
WT.	2.81	lb/ft
θsa	2.10	°C/w/3"

**21153**

Per.	21.43	in.
WT.	0.89	lb/ft
θsa	3.26	°C/w/3"

**XX7150**

Per.	32.42	in.
WT.	2.85	lb/ft
θsa	2.40	°C/w/3"

**B 012614**

Per.	33.85	in.
WT.	1.63	lb/ft
θsa	2.10	°C/w/3"

**012777**

Per.	39.24	in.
WT.	1.77	lb/ft
θsa	1.80	°C/w/3"

**013717**

Per.	55.74	in.
WT.	2.44	lb/ft
θsa	1.30	°C/w/3"

**B 013664**

Per.	33.16	in.
WT.	3.45	lb/ft
θsa	2.10	°C/w/3"

**12447**

Per.	42.64	in.
WT.	5.23	lb/ft
θsa	1.64	°C/w/3"

**016652**

Per.	36.63	in.
WT.	3.66	lb/ft
θsa	1.70	°C/w/3"

**C 016374**

Per.	57.59	in.
WT.	3.29	lb/ft
θsa	2.30	°C/w/3"

**012918**

Per.	58.19	in.
WT.	3.74	lb/ft
θsa	1.20	°C/w/3"

**21105**

Per.	34.97	in.
WT.	4.20	lb/ft
θsa	2.00	°C/w/3"

**C 016242**

Per.	32.67	in.
WT.	3.07	lb/ft
θsa	2.30	°C/w/3"

**XX2030**

Per.	19.68	in.
WT.	1.40	lb/ft
θsa	2.40	°C/w/3"

**011005**

Per.	20.12	in.
WT.	1.05	lb/ft
θsa	3.50	°C/w/3"

**D 21139**

Per.	55.67	in.
WT.	5.45	lb/ft
θsa	1.26	°C/w/3"

**014965**

Per.	40.63	in.
WT.	1.52	lb/ft
θsa	1.70	°C/w/3"

**013203**

Per.	50.60	in.
WT.	3.17	lb/ft
θsa	1.40	°C/w/3"

**D 12405**

Per.	21.41	in.
WT.	1.30	lb/ft
θsa	3.27	°C/w/3"

**011942**

Per.	30.87	in.
WT.	1.60	lb/ft
θsa	2.30	°C/w/3"

**016123**

Per.	37.14	in.
WT.	3.09	lb/ft
θsa	3.60	°C/w/3"

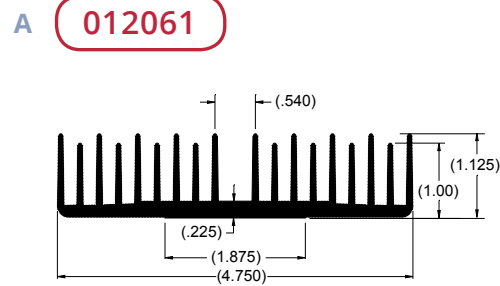

Per.	47.09	in.
WT.	2.40	lb/ft
θsa	1.50	°C/w/3"

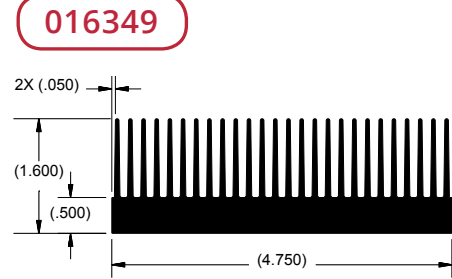

Per.	65.77	in.
WT.	5.04	lb/ft
θsa	3.80	°C/w/3"

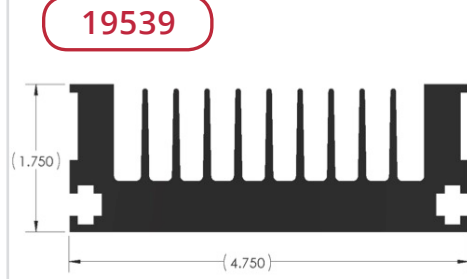

Per.	36.72	in.
WT.	5.37	lb/ft
θsa	1.90	°C/w/3"

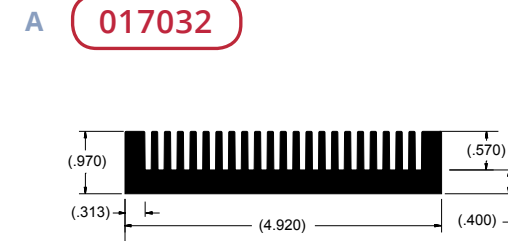

Per.	2.70	in.
WT.	4.11	lb/ft
θsa	4.80	°C/w/3"

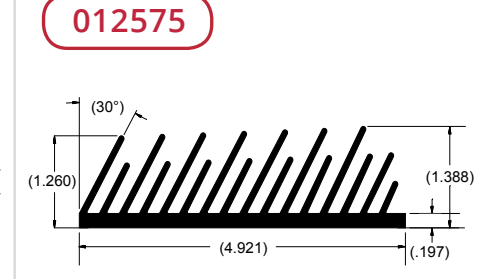

Per.	45.17	in.
WT.	2.92	lb/ft
θsa	1.50	°C/w/3"

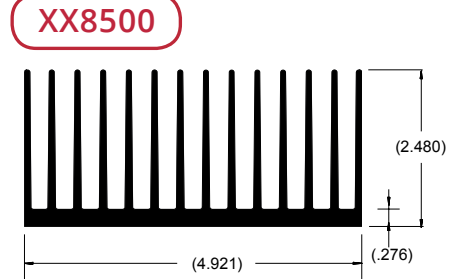

Per.	60.50	in.
WT.	6.47	lb/ft
θsa	1.30	°C/w/3"

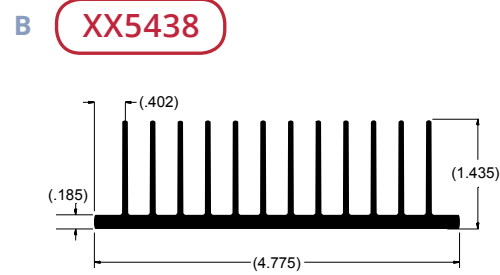

Per.	39.26	in.
WT.	2.41	lb/ft
θsa	1.80	°C/w/3"

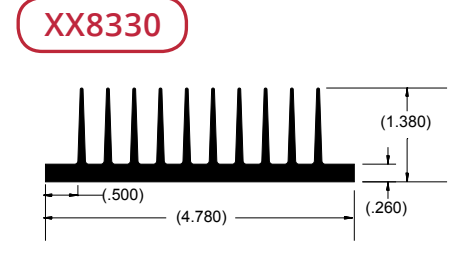

Per.	31.15	in.
WT.	2.50	lb/ft
θsa	1.90	°C/w/3"

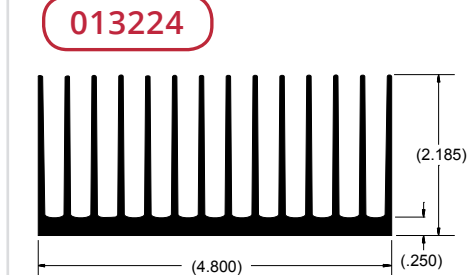

Per.	63.47	in.
WT.	3.88	lb/ft
θsa	1.10	°C/w/3"

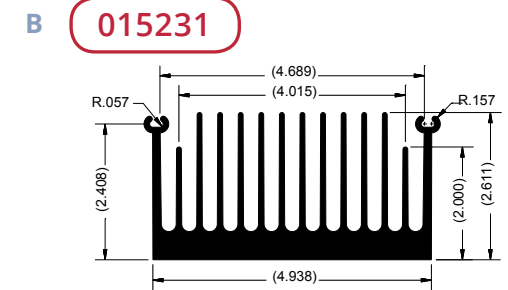

Per.	66.74	in.
WT.	6.52	lb/ft
θsa	1.60	°C/w/3"

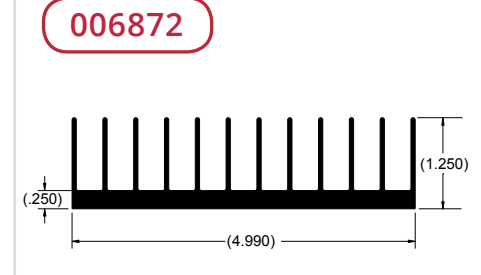

Per.	34.48	in.
WT.	2.39	lb/ft
θsa	2.00	°C/w/3"

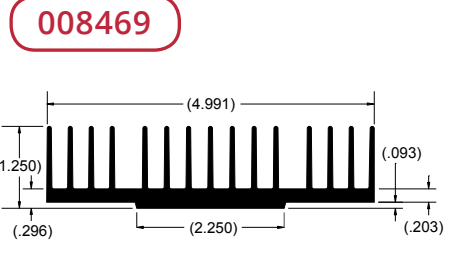

Per.	38.65	in.
WT.	2.74	lb/ft
θsa	2.40	°C/w/3"

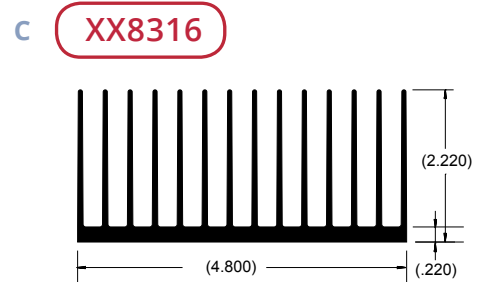

Per.	64.95	in.
WT.	3.52	lb/ft
θsa	1.40	°C/w/3"

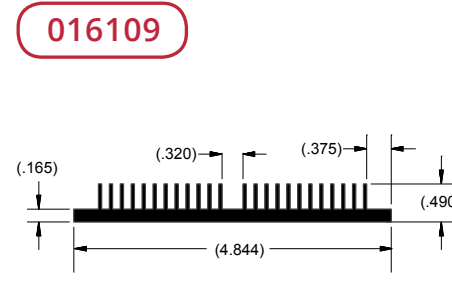

Per.	25.62	in.
WT.	1.43	lb/ft
θsa	4.84	°C/w/3"

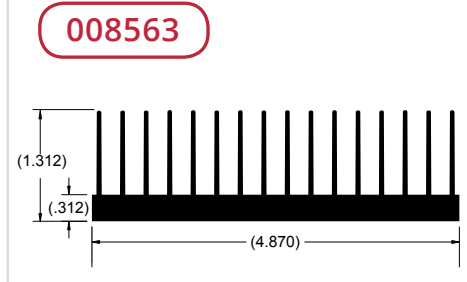

Per.	42.36	in.
WT.	3.07	lb/ft
θsa	1.70	°C/w/3"

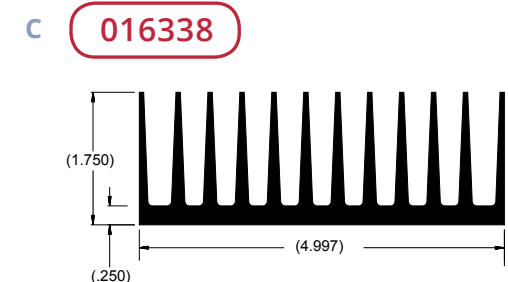

Per.	44.54	in.
WT.	4.08	lb/ft
θsa	1.70	°C/w/3"

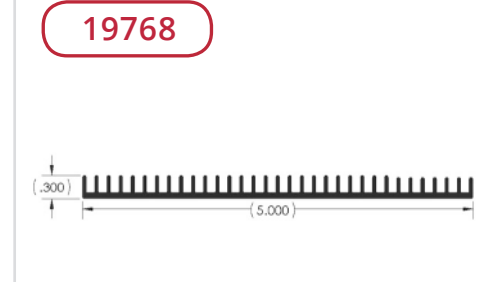

Per.	23.34	in.
WT.	0.89	lb/ft
θsa	3.00	°C/w/3"

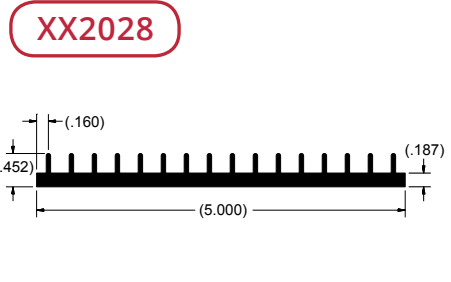

Per.	18.44	in.
WT.	1.42	lb/ft
θsa	3.00	°C/w/3"

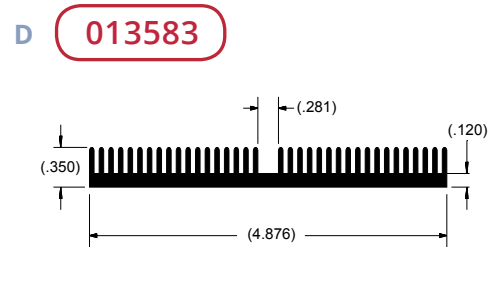

Per.	25.59	in.
WT.	1.30	lb/ft
θsa	2.70	°C/w/3"

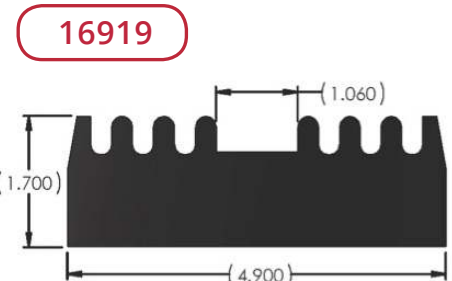

Per.	18.51	in.
WT.	8.34	lb/ft
θsa	3.78	°C/w/3"

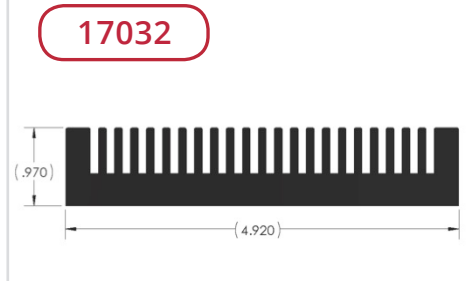

Per.	36.47	in.
WT.	4.31	lb/ft
θsa	1.92	°C/w/3"

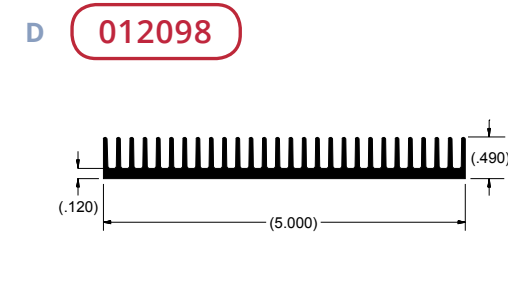

Per.	29.33	in.
WT.	1.38	lb/ft
θsa	2.40	°C/w/3"

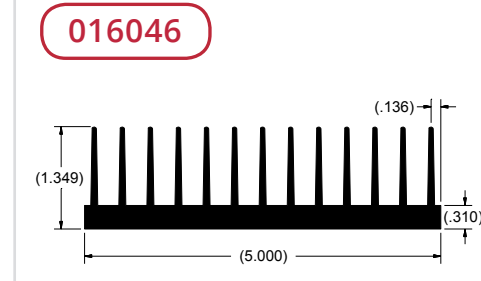

Per.	18.44	in.
WT.	1.42	lb/ft
θsa	2.10	°C/w/3"

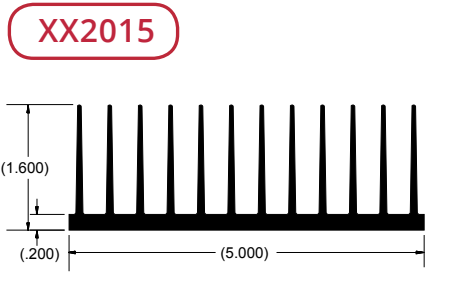

Per.	42.85	in.
WT.	2.75	lb/ft
θsa	1.60	°C/w/3"

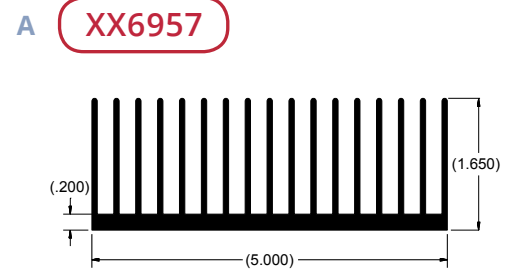

Per.	58.68	in.
WT.	3.32	lb/ft
θsa	1.50	°C/w/3"

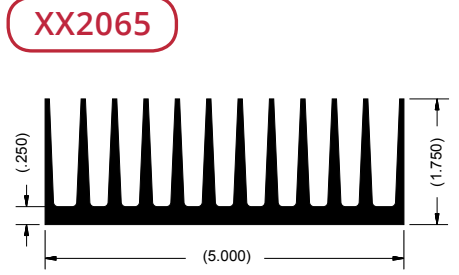

Per.	44.59	in.
WT.	4.08	lb/ft
θsa	1.60	°C/w/3"

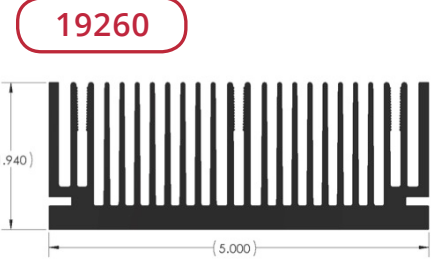

Per.	87.86	in.
WT.	5.49	lb/ft
θsa	0.80	°C/w/3"

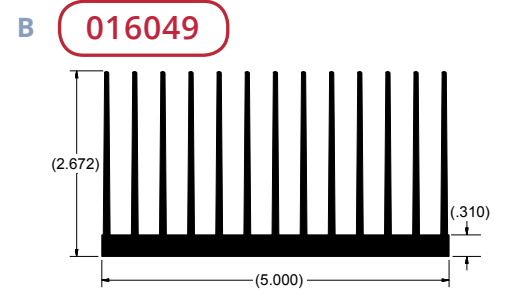

Per.	71.21	in.
WT.	4.76	lb/ft
θsa	1.40	°C/w/3"

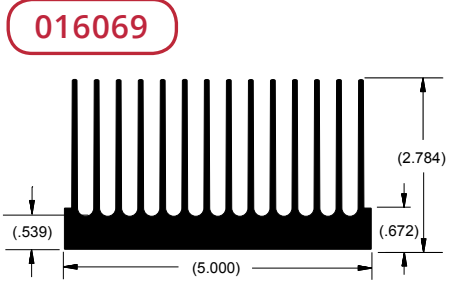

Per.	71.73	in.
WT.	6.65	lb/ft
θsa	1.50	°C/w/3"

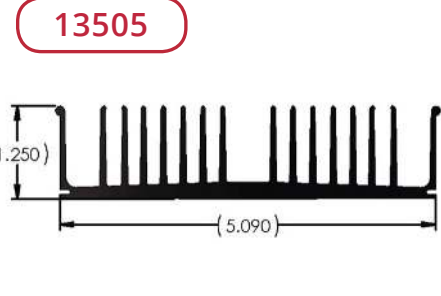

Per.	43.60	in.
WT.	2.61	lb/ft
θsa	1.60	°C/w/3"

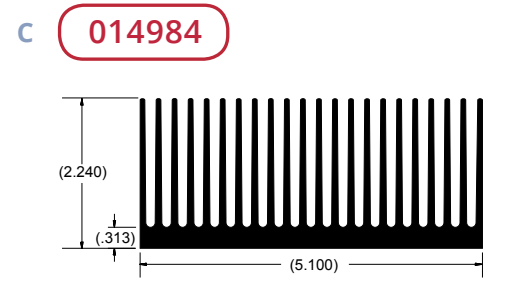

Per.	93.10	in.
WT.	5.28	lb/ft
θsa	1.80	°C/w/3"

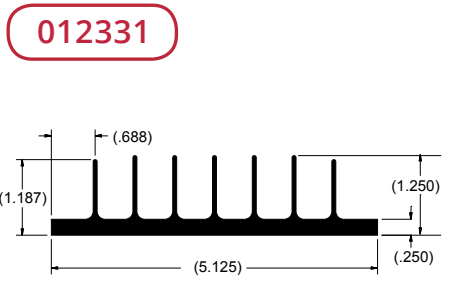

Per.	23.69	in.
WT.	2.04	lb/ft
θsa	3.00	°C/w/3"

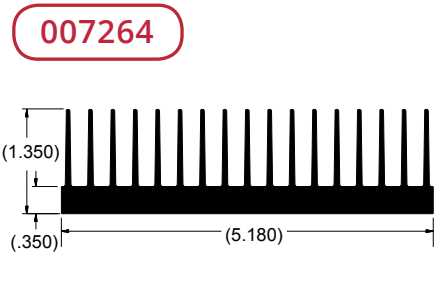

Per.	45.06	in.
WT.	3.50	lb/ft
θsa	1.60	°C/w/3"

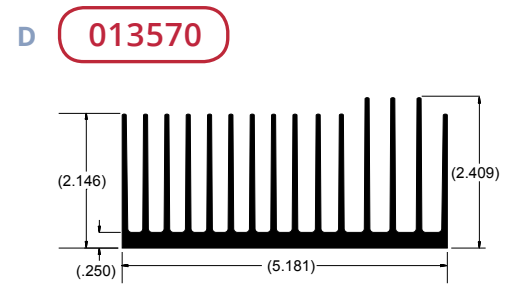

Per.	67.82	in.
WT.	4.28	lb/ft
θsa	1.60	°C/w/3"

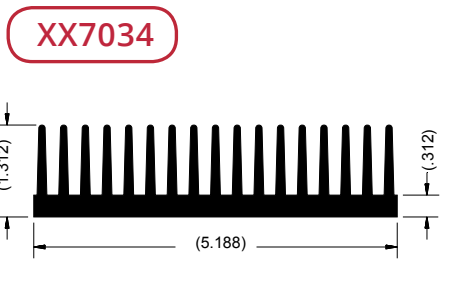

Per.	43.85	in.
WT.	3.52	lb/ft
θsa	1.70	°C/w/3"

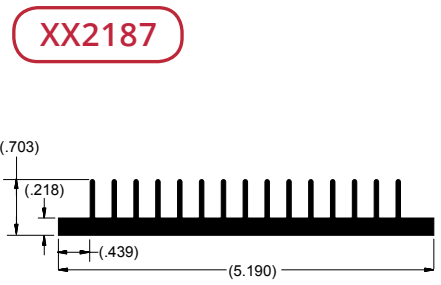

Per.	24.79	in.
WT.	1.90	lb/ft
θsa	2.90	°C/w/3"

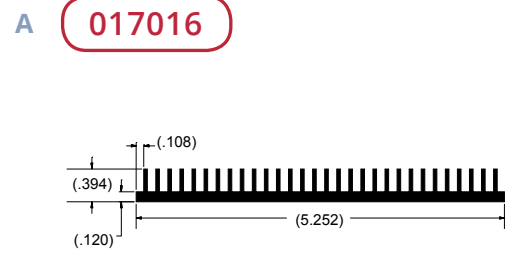

Per.	27.19	in.
WT.	1.26	lb/ft
θsa	4.90	°C/w/3"

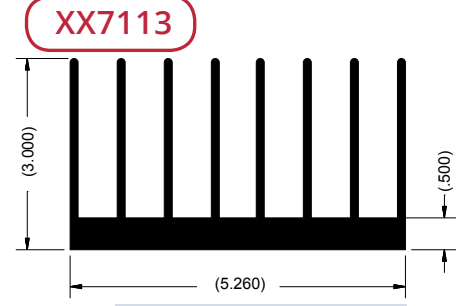

Per.	51.00	in.
WT.	6.73	lb/ft
θsa	1.10	°C/w/3"

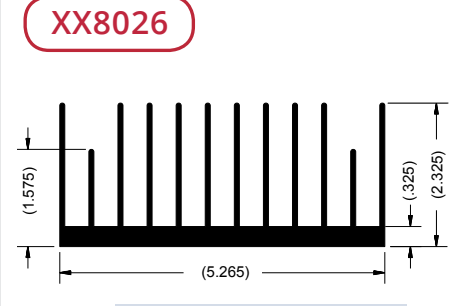

Per.	55.37	in.
WT.	4.40	lb/ft
θsa	1.30	°C/w/3"

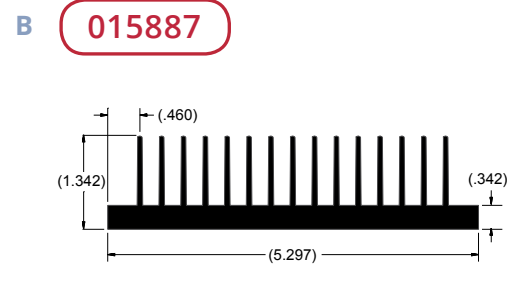

Per.	40.63	in.
WT.	3.46	lb/ft
θsa	2.40	°C/w/3"

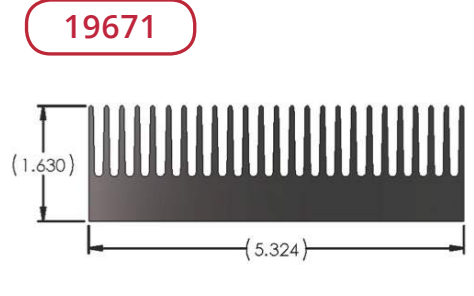

Per.	59.37	in.
WT.	6.37	lb/ft
θsa	1.18	°C/w/3"

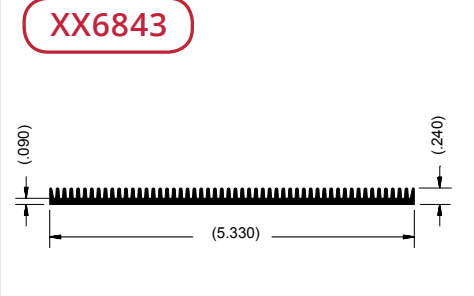

Per.	23.00	in.
WT.	1.02	lb/ft
θsa	1.02	°C/w/3"

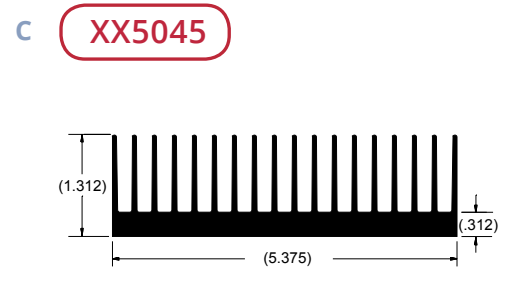

Per.	47.33	in.
WT.	3.55	lb/ft
θsa	1.80	°C/w/3"

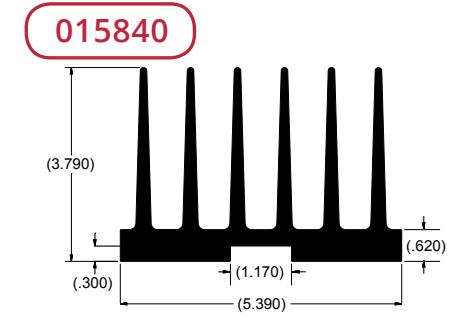

Per.	49.36	in.
WT.	8.43	lb/ft
θsa	1.10	°C/w/3"

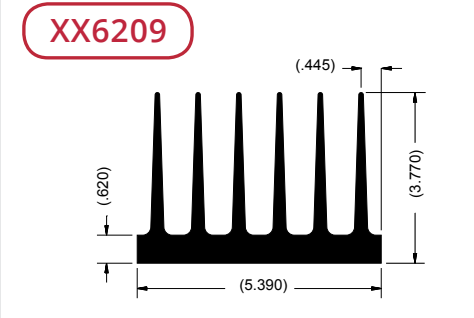

Per.	47.52	in.
WT.	8.60	lb/ft
θsa	1.40	°C/w/3"

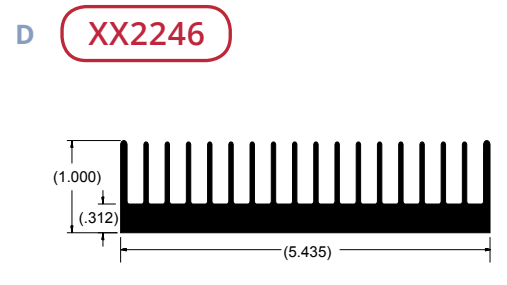

Per.	35.25	in.
WT.	3.02	lb/ft
θsa	1.90	°C/w/3"

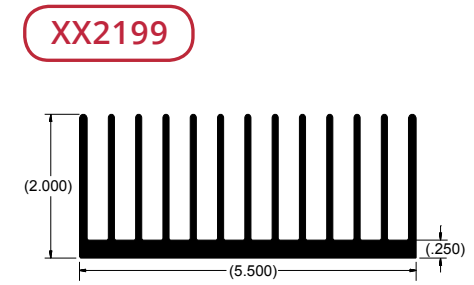

Per.	57.00	in.
WT.	4.48	lb/ft
θsa	1.20	°C/w/3"

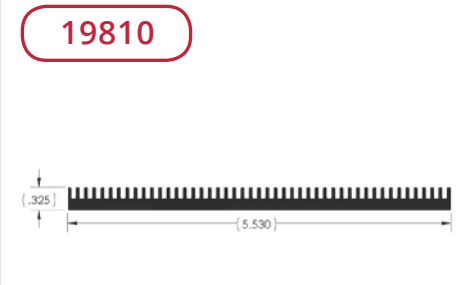

Per.	24.76	in.
WT.	1.60	lb/ft
θsa	2.82	°C/w/3"

**A XX2002**

Per.	41.90	in.
WT.	3.67	lb/ft
θsa	1.50	°C/w/3"

**XX6933**

Per.	35.45	in.
WT.	1.85	lb/ft
θsa	1.80	°C/w/3"

**19036**

Per.	65.83	in.
WT.	3.26	lb/ft
θsa	1.06	°C/w/3"

**A XX8415**

Per.	81.69	in.
WT.	7.37	lb/ft
θsa	1.30	°C/w/3"

**013237**

Per.	38.67	in.
WT.	2.10	lb/ft
θsa	1.80	°C/w/3"

**016060**

Per.	81.06	in.
WT.	7.97	lb/ft
θsa	1.30	°C/w/3"

**B 19350**

Per.	138.05	in.
WT.	7.10	lb/ft
θsa	0.51	°C/w/3"

**016253**

Per.	41.36	in.
WT.	4.06	lb/ft
θsa	2.00	°C/w/3"

**016138**

Per.	64.08	in.
WT.	5.62	lb/ft
θsa	2.20	°C/w/3"

**B 013601**

Per.	59.01	in.
WT.	2.86	lb/ft
θsa	1.20	°C/w/3"

**014462**

Per.	65.25	in.
WT.	3.89	lb/ft
θsa	1.10	°C/w/3"

**19343**

Per.	74.30	in.
WT.	7.79	lb/ft
θsa	0.94	°C/w/3"

**C 19155**

Per.	44.62	in.
WT.	2.73	lb/ft
θsa	1.57	°C/w/3"

**012671**

Per.	26.67	in.
WT.	1.29	lb/ft
θsa	2.60	°C/w/3"

**XX2903**

Per.	23.87	in.
WT.	1.72	lb/ft
θsa	2.80	°C/w/3"

**C 002981**

Per.	40.00	in.
WT.	2.90	lb/ft
θsa	1.70	°C/w/3"

**21257**

Per.	49.78	in.
WT.	7.73	lb/ft
θsa	1.40	°C/w/3"

**14407**

Per.	85.79	in.
WT.	5.47	lb/ft
θsa	0.81	°C/w/3"

**D 013532**

Per.	64.81	in.
WT.	4.02	lb/ft
θsa	1.10	°C/w/3"

**010248**

Per.	59.80	in.
WT.	5.31	lb/ft
θsa	1.20	°C/w/3"

**15037**

Per.	40.40	in.
WT.	1.89	lb/ft
θsa	1.73	°C/w/3"

**D 016168**

Per.	72.89	in.
WT.	3.78	lb/ft
θsa	1.90	°C/w/3"

**011743**

Per.	36.74	in.
WT.	1.59	lb/ft
θsa	1.90	°C/w/3"

**012464**

Per.	49.68	in.
WT.	3.61	lb/ft
θsa	1.40	°C/w/3"



**A 013796**

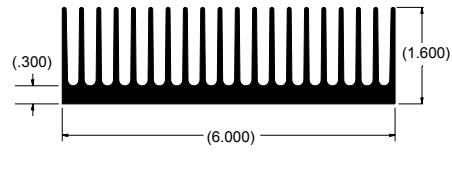

Per.	61.82	in.
WT.	4.76	lb/ft
θsa	1.10	°C/w/3"

**19341**

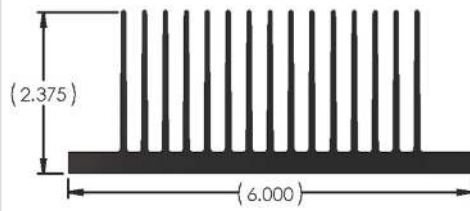

Per.	73.88	in.
WT.	5.07	lb/ft
θsa	0.95	°C/w/3"

**19864**

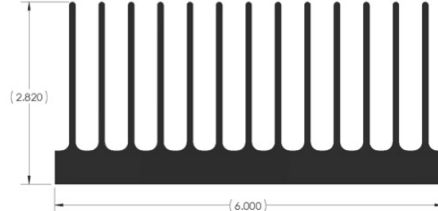

Per.	70.81	in.
WT.	7.43	lb/ft
θsa	0.99	°C/w/3"

**A 016188**

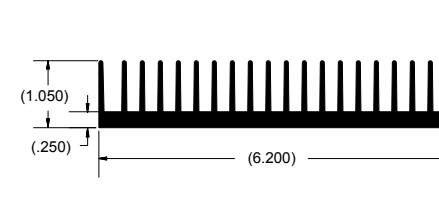

Per.	43.90	in.
WT.	3.38	lb/ft
θsa	2.50	°C/w/3"

**016187**

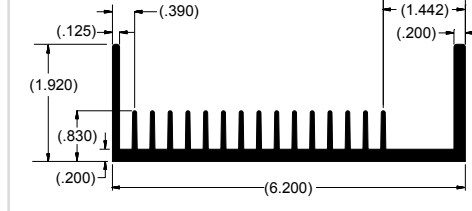

Per.	37.74	in.
WT.	3.05	lb/ft
θsa	2.70	°C/w/3"

**012693**

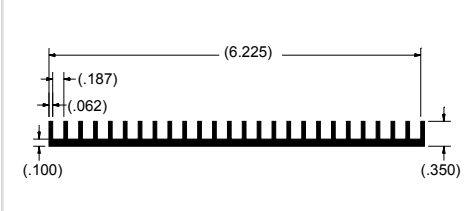

Per.	25.77	in.
WT.	1.24	lb/ft
θsa	2.70	°C/w/3"

**B 016070**

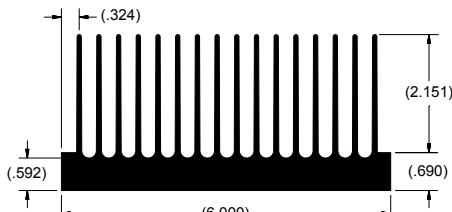

Per.	82.68	in.
WT.	8.16	lb/ft
θsa	1.60	°C/w/3"

**XX10138**

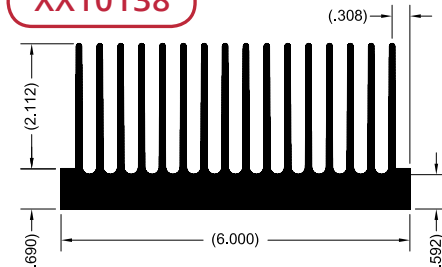

Per.	82.67	in.
WT.	8.17	lb/ft
θsa	0.97	°C/w/3"

**012054**

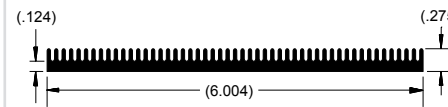

Per.	25.08	in.
WT.	1.32	lb/ft
θsa	2.80	°C/w/3"

**B XX8144**



Per.	61.81	in.
WT.	3.78	lb/ft
θsa	1.70	°C/w/3"

**XX5067**

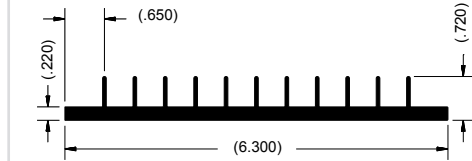

Per.	23.76	in.
WT.	2.07	lb/ft
θsa	2.70	°C/w/3"

**21848**

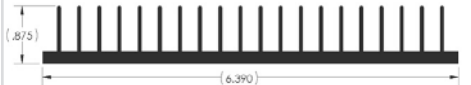

Per.	40.03	in.
WT.	2.47	lb/ft
θsa	1.75	°C/w/3"

**C 016250**

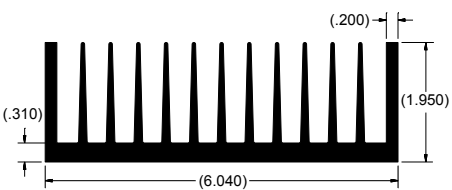

Per.	53.84	in.
WT.	5.27	lb/ft
θsa	1.40	°C/w/3"

**XX6676**



Per.	50.73	in.
WT.	3.56	lb/ft
θsa	1.30	°C/w/3"

**013277**

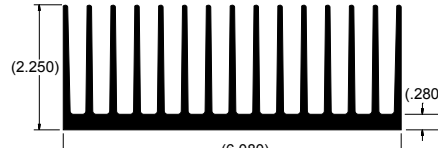

Per.	69.93	in.
WT.	5.53	lb/ft
θsa	1.40	°C/w/3"

**C 12382**

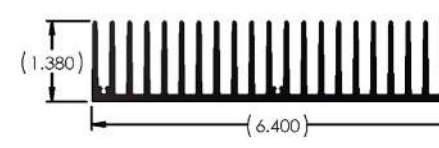

Per.	66.42	in.
WT.	3.81	lb/ft
θsa	1.05	°C/w/3"

**003385**

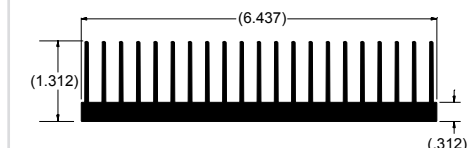

Per.	54.75	in.
WT.	4.03	lb/ft
θsa	1.30	°C/w/3"

**21107**

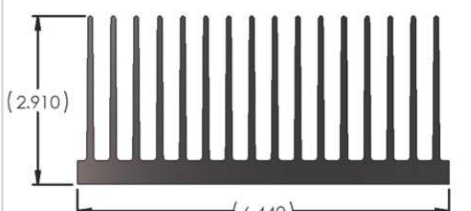

Per.	91.72	in.
WT.	7.98	lb/ft
θsa	0.76	°C/w/3"

**D 013512**

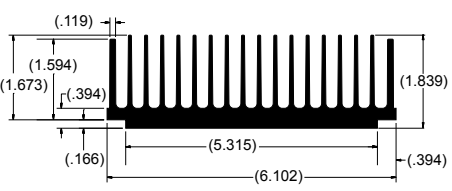

Per.	62.47	in.
WT.	5.21	lb/ft
θsa	1.10	°C/w/3"

**XX2161**

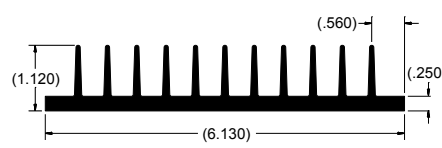

Per.	30.72	in.
WT.	2.96	lb/ft
θsa	1.80	°C/w/3"

**011425**

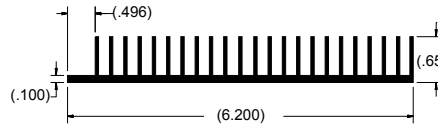

Per.	37.71	in.
WT.	1.61	lb/ft
θsa	1.90	°C/w/3"

**D 013266**

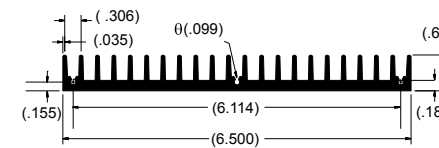

Per.	32.29	in.
WT.	2.38	lb/ft
θsa	2.20	°C/w/3"

**006664**

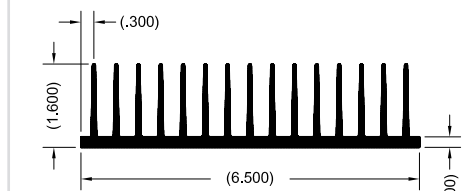

Per.	56.00	in.
WT.	3.42	lb/ft
θsa	0.0	°C/w/3"

**XX8403**

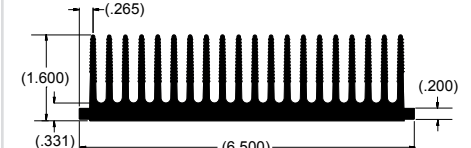

Per.	61.19	in.
WT.	5.49	lb/ft
θsa	1.30	°C/w/3"

**A XX4509**

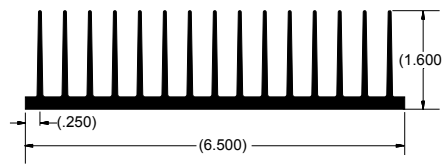

Per.	53.80	in.
WT.	3.45	lb/ft
θsa	1.30	°C/w/3"

**016593**

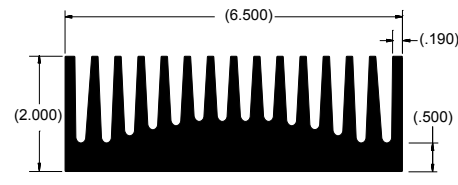

Per.	50.24	in.
WT.	10.17	lb/ft
θsa	1.60	°C/w/3"

**016607**

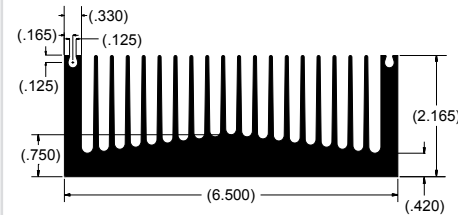

Per.	75.67	in.
WT.	8.54	lb/ft
θsa	1.40	°C/w/3"

**A XX2494**

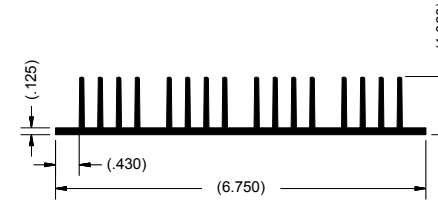

Per.	46.37	in.
WT.	2.65	lb/ft
θsa	1.70	°C/w/3"

**XX2027**

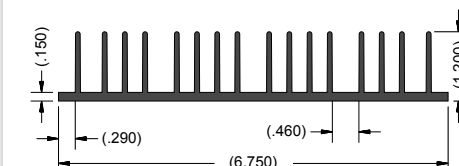

Per.	46.69	in.
WT.	2.91	lb/ft
θsa	1.40	°C/w/3"

**19596**

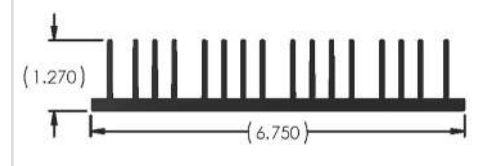

Per.	47.01	in.
WT.	3.49	lb/ft
θsa	1.49	°C/w/3"

**B 016222**

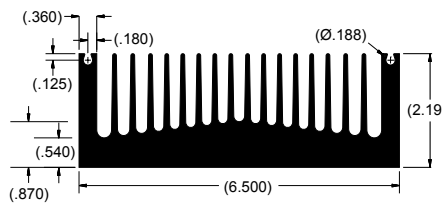

Per.	65.32	in.
WT.	9.66	lb/ft
θsa	1.40	°C/w/3"

**013621**

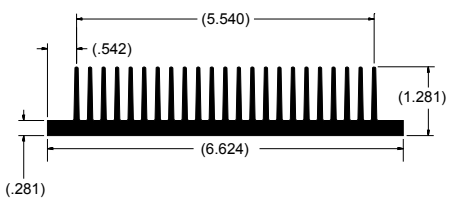

Per.	57.72	in.
WT.	4.31	lb/ft
θsa	2.70	°C/w/3"

**XX7031**

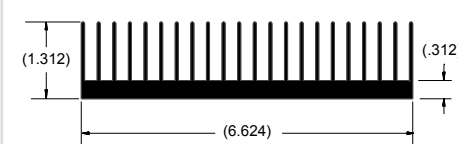

Per.	57.29	in.
WT.	4.12	lb/ft
θsa	1.30	°C/w/3"

**B 012116**

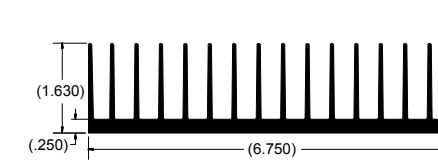

Per.	56.90	in.
WT.	4.00	lb/ft
θsa	1.60	°C/w/3"

**015769**

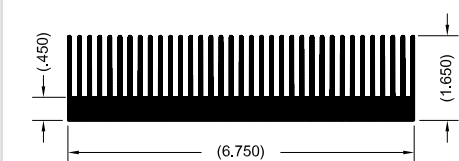

Per.	97.40	in.
WT.	6.53	lb/ft
θsa	1.70	°C/w/3"

**XX7029**

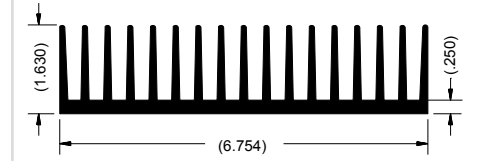

Per.	57.28	in.
WT.	4.08	lb/ft
θsa	1.30	°C/w/3"

**C 12714**

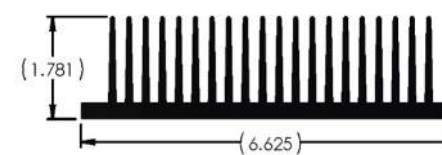

Per.	71.70	in.
WT.	5.99	lb/ft
θsa	0.98	°C/w/3"

**015906**

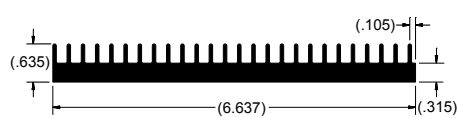

Per.	29.17	in.
WT.	3.15	lb/ft
θsa	3.30	°C/w/3"

**19679**

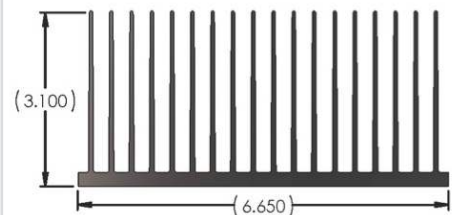

Per.	116.00	in.
WT.	6.65	lb/ft
θsa	0.60	°C/w/3"

**C 19333**

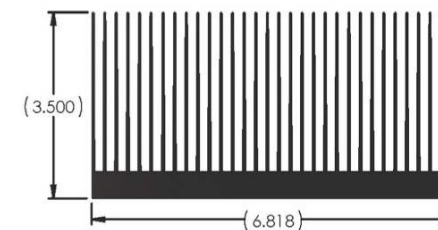

Per.	205.33	in.
WT.	9.80	lb/ft
θsa	0.34	°C/w/3"

**16335**

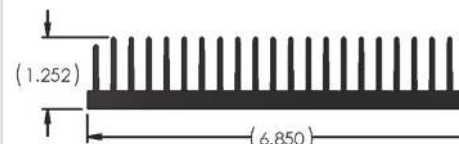

Per.	53.53	in.
WT.	4.67	lb/ft
θsa	1.31	°C/w/3"

**016362**

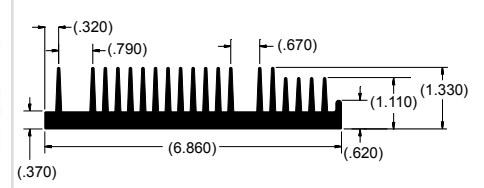

Per.	47.30	in.
WT.	5.14	lb/ft
θsa	2.50	°C/w/3"

**D 014746**

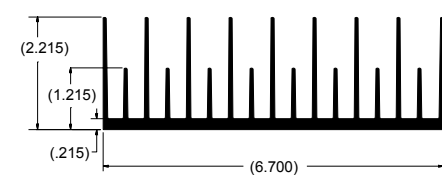

Per.	65.00	in.
WT.	3.80	lb/ft
θsa	1.20	°C/w/3"

**21081**

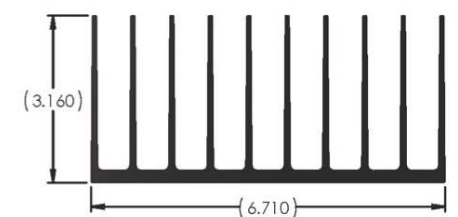

Per.	70.97	in.
WT.	5.55	lb/ft
θsa	0.99	°C/w/3"

**013659**

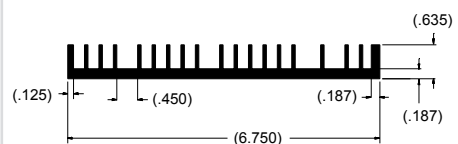

Per.	31.75	in.
WT.	2.40	lb/ft
θsa	2.20	°C/w/3"

**D XX2071**

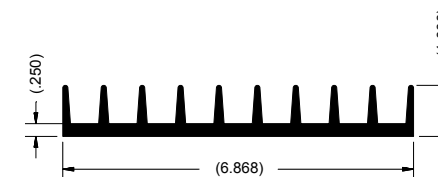

Per.	27.94	in.
WT.	3.33	lb/ft
θsa	1.90	°C/w/3"

**015633**

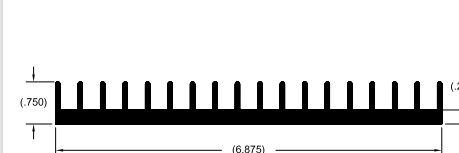

Per.	31.38	in.
WT.	2.86	lb/ft
θsa	2.30	°C/w/3"

**016290**

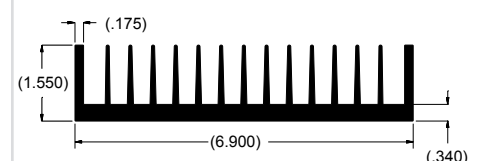

Per.	49.47	in.
WT.	5.04	lb/ft
θsa	1.50	°C/w/3"

**A 015745**

Per.	79.31	in.
WT.	6.91	lb/ft
θsa	1.40	°C/w/3"

**XX6274**

Per.	97.90	in.
WT.	9.15	lb/ft
θsa	0.80	°C/w/3"

**XX2091**

Per.	57.81	in.
WT.	4.70	lb/ft
θsa	1.20	°C/w/3"

**B 16373**

Per.	78.13	in.
WT.	8.87	lb/ft
θsa	0.89	°C/w/3"

**19493**

Per.	26.00	in.
WT.	1.63	lb/ft
θsa	2.69	°C/w/3"

**015837**

Per.	123.97	in.
WT.	9.16	lb/ft
θsa	1.30	°C/w/3"

**C 014306**

Per.	127.28	in.
WT.	10.34	lb/ft
θsa	0.90	°C/w/3"

**006369**

Per.	54.70	in.
WT.	4.57	lb/ft
θsa	1.70	°C/w/3"

**014757**

Per.	33.06	in.
WT.	2.34	lb/ft
θsa	2.10	°C/w/3"

**D 014401**

Per.	45.17	in.
WT.	3.79	lb/ft
θsa	1.60	°C/w/3"

**006663**

Per.	44.10	in.
WT.	5.28	lb/ft
θsa	2.50	°C/w/3"

**016556**

Per.	49.55	in.
WT.	2.47	lb/ft
θsa	5.30	°C/w/3"

**A XX7063**

Per.	59.37	in.
WT.	4.74	lb/ft
θsa	1.20	°C/w/3"

**012414**

Per.	46.41	in.
WT.	1.77	lb/ft
θsa	1.50	°C/w/3"

**19536**

Per.	47.12	in.
WT.	2.77	lb/ft
θsa	1.48	°C/w/3"

**B 013929**

Per.	80.79	in.
WT.	6.03	lb/ft
θsa	0.90	°C/w/3"

**19113**

Per.	62.04	in.
WT.	5.99	lb/ft
θsa	1.13	°C/w/3"

**012395**

Per.	52.74	in.
WT.	6.18	lb/ft
θsa	1.30	°C/w/3"

**C XX4771**

Per.	61.75	in.
WT.	4.54	lb/ft
θsa	1.10	°C/w/3"

**013597**

Per.	59.05	in.
WT.	4.20	lb/ft
θsa	1.20	°C/w/3"

**XX5523**

Per.	46.78	in.
WT.	2.88	lb/ft
θsa	1.80	°C/w/3"

**D 19273**

Per.	136.54	in.
WT.	17.21	lb/ft
θsa	0.51	°C/w/3"

**014113**

Per.	116.11	in.
WT.	7.30	lb/ft
θsa	0.60	°C/w/3"

**013677**

Per.	107.22	in.
WT.	7.68	lb/ft
θsa	0.60	°C/w/3"

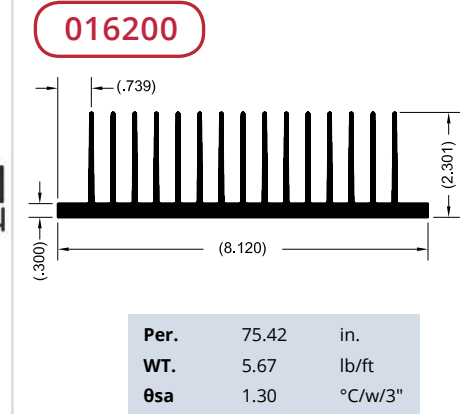
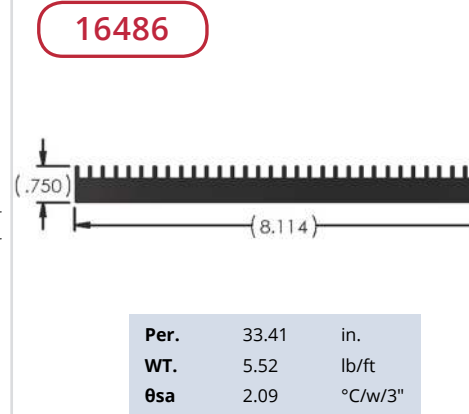
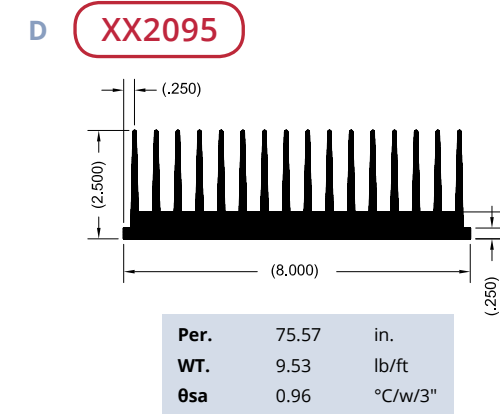
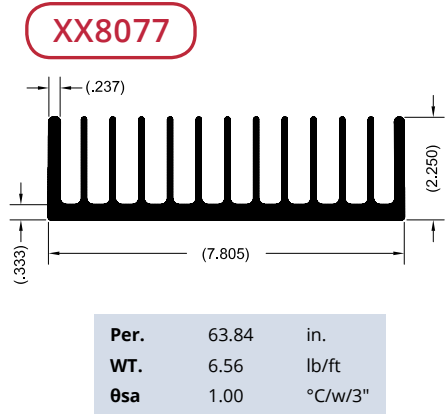
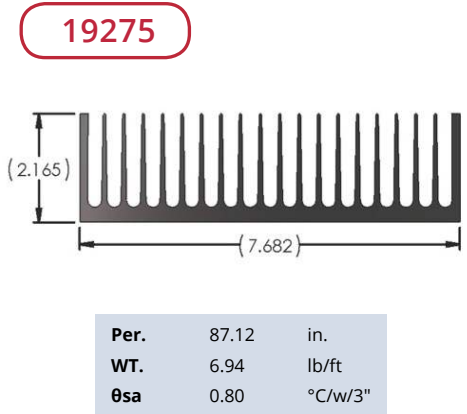
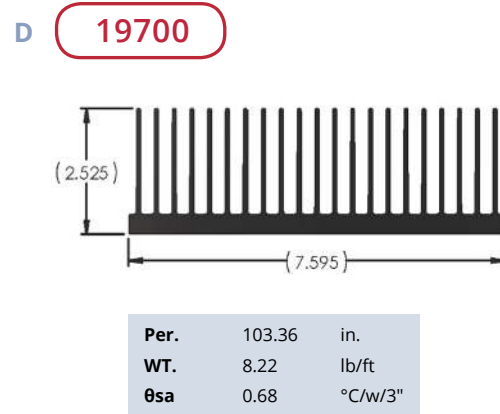
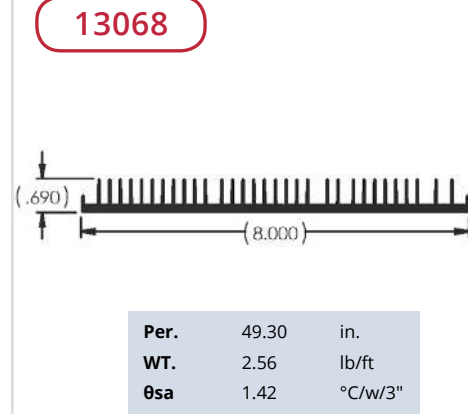
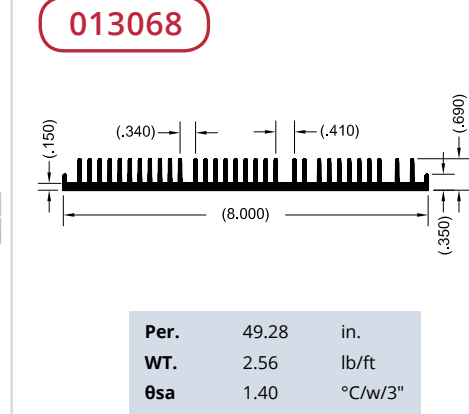
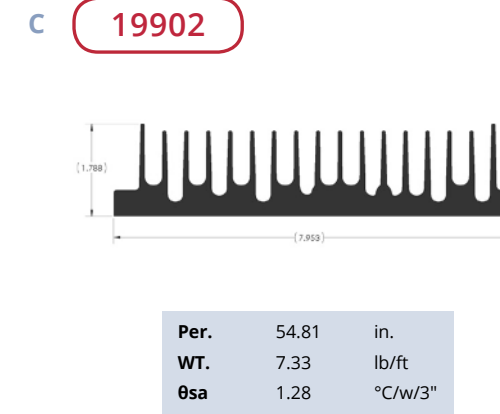
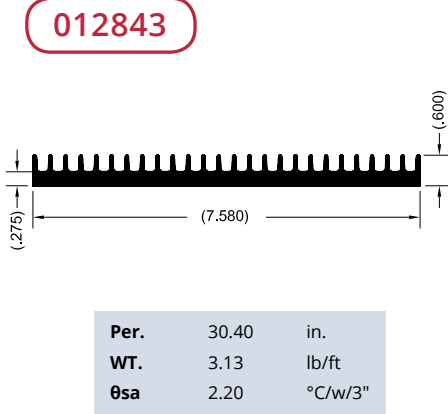
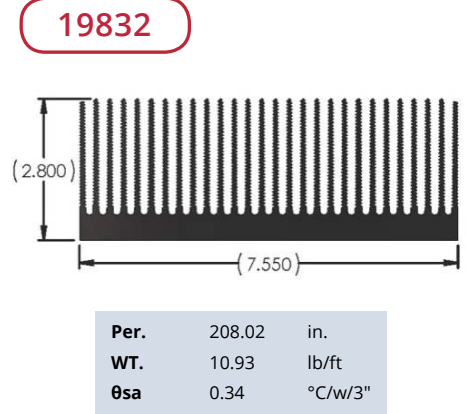
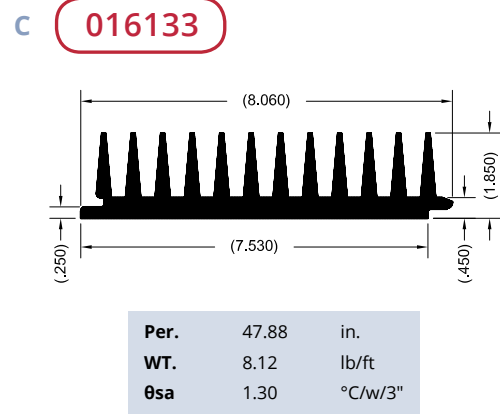
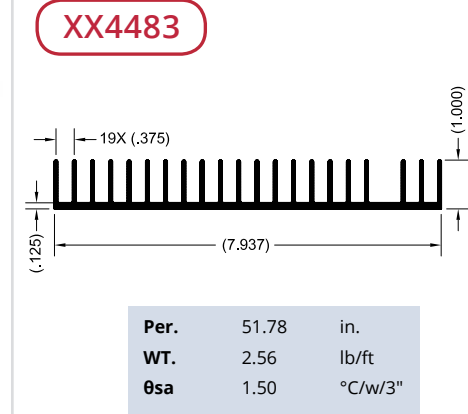
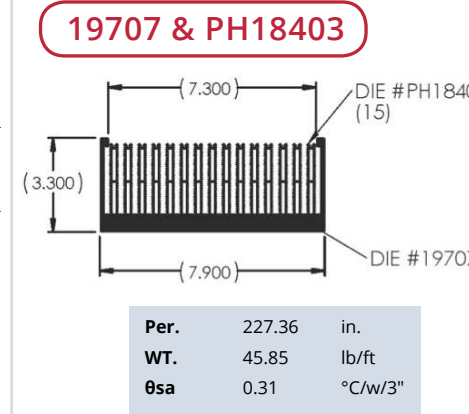
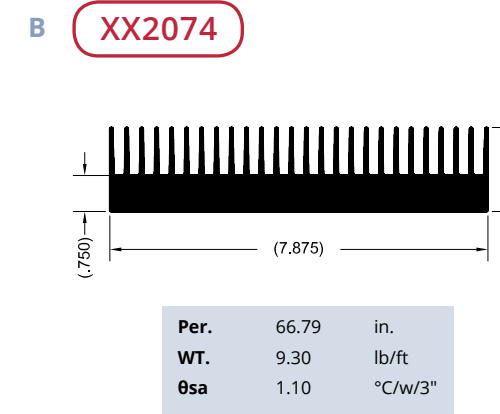
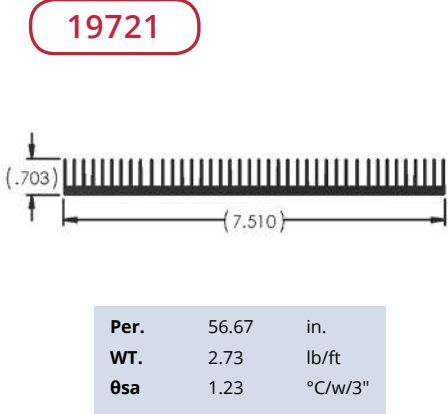
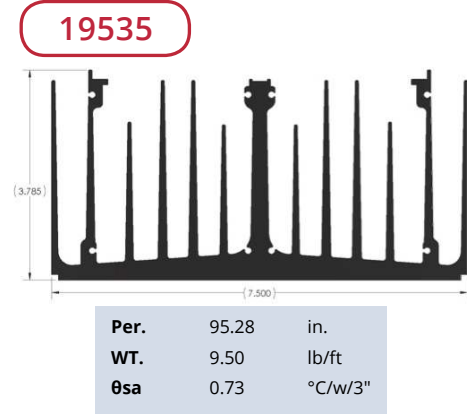
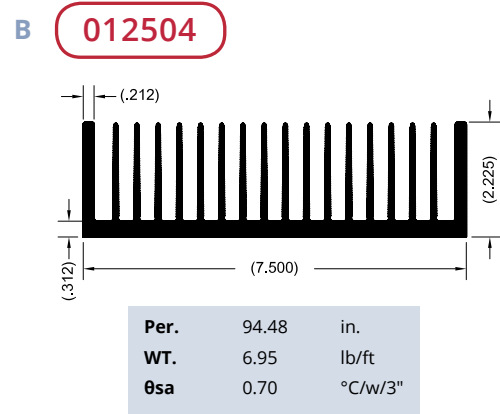
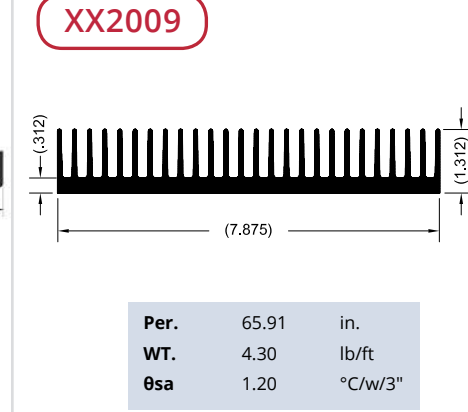
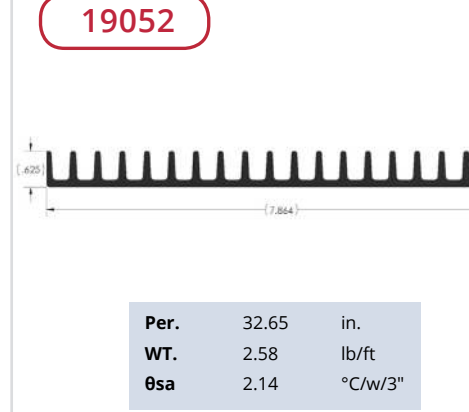
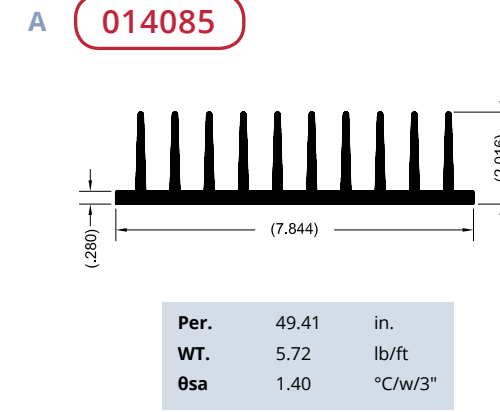
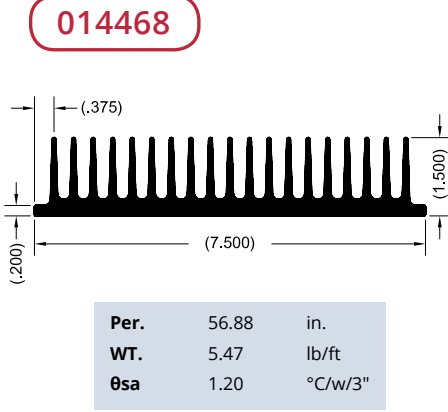
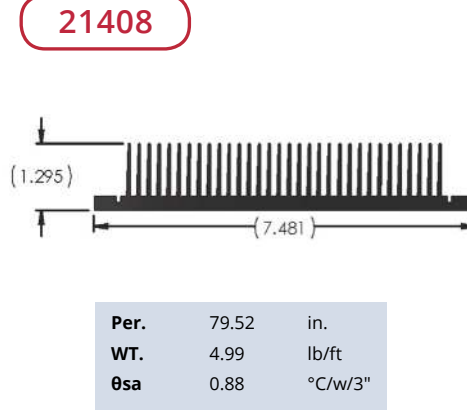
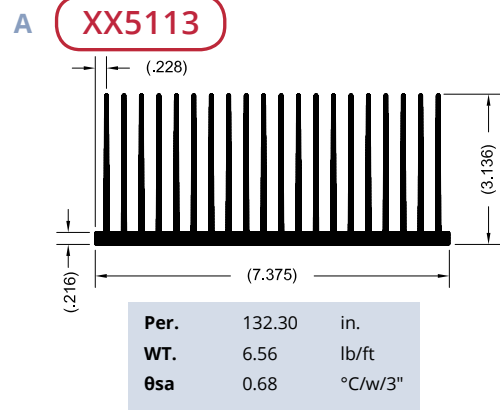



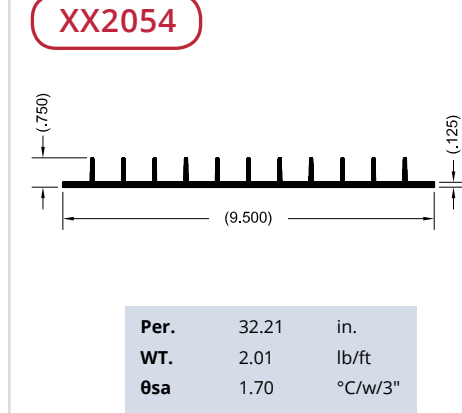
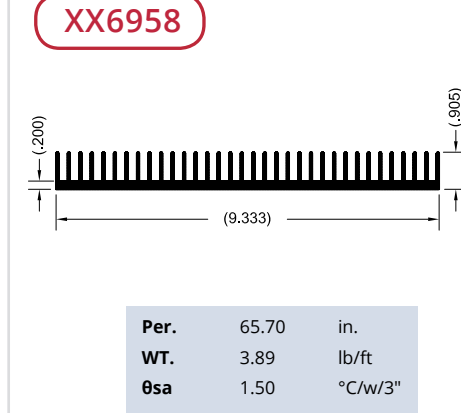
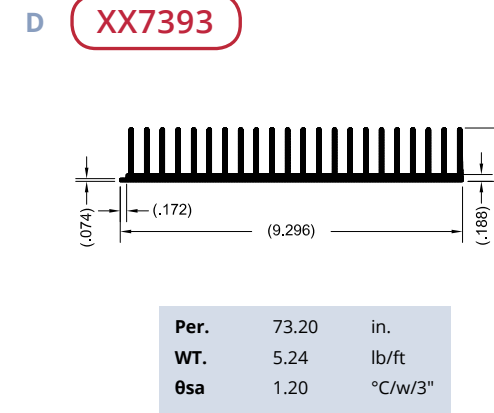
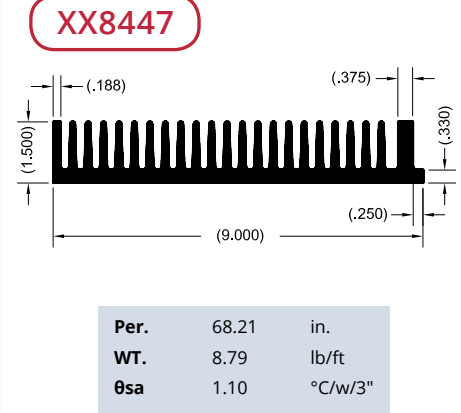
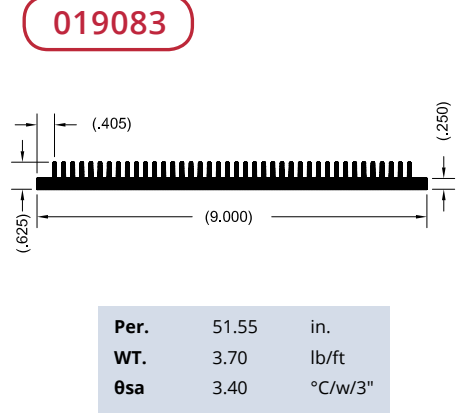
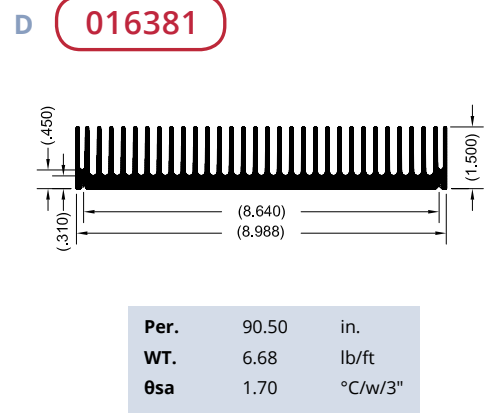
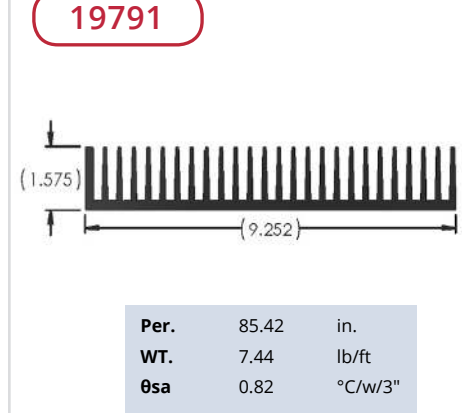
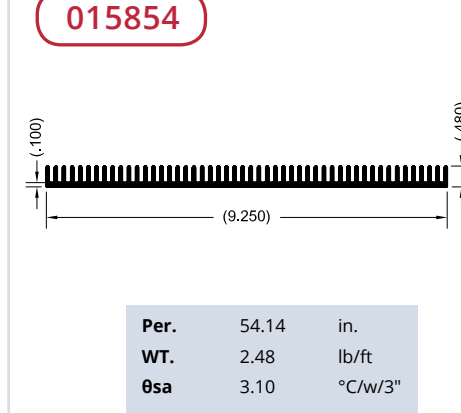
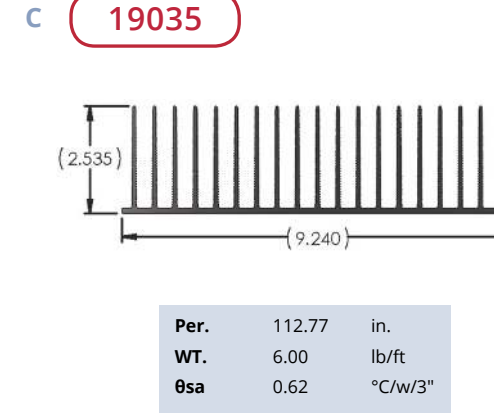
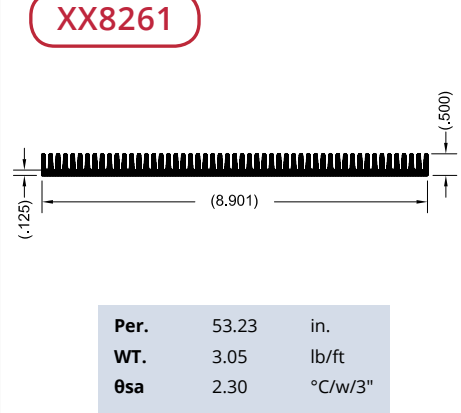
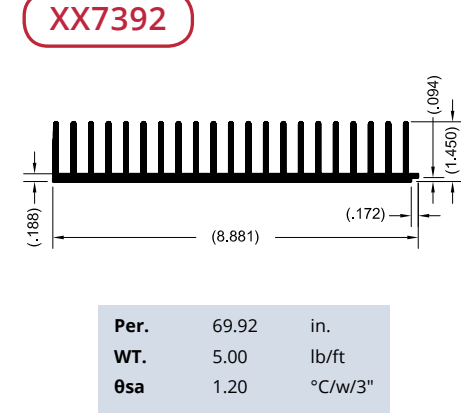
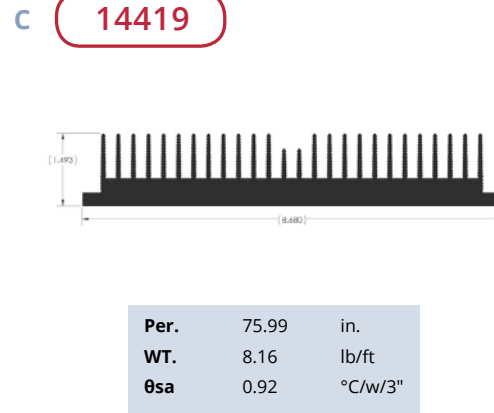
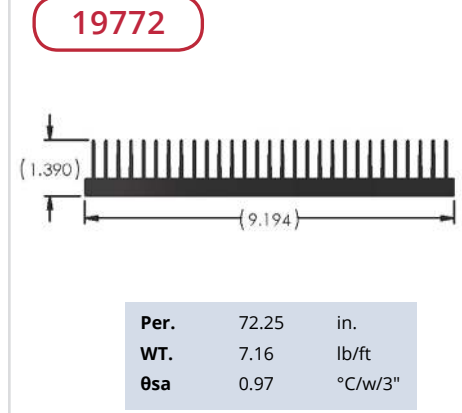
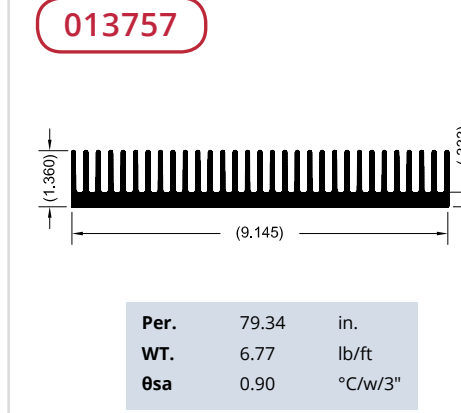
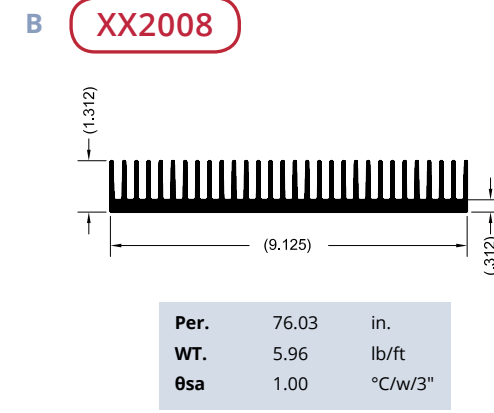
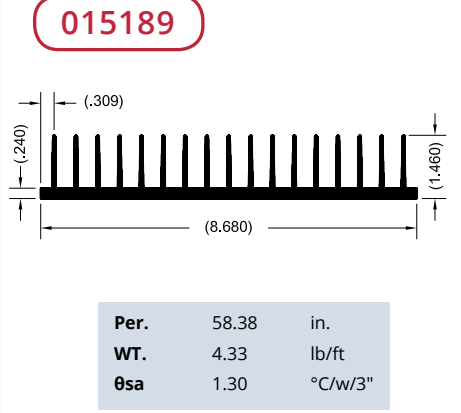
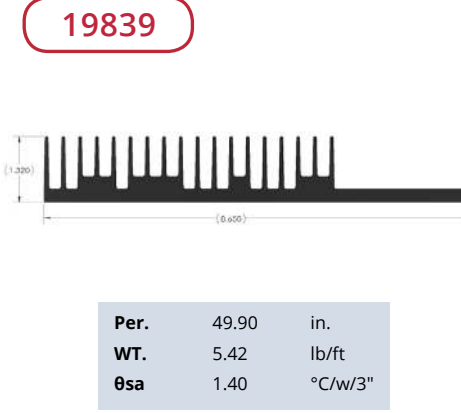
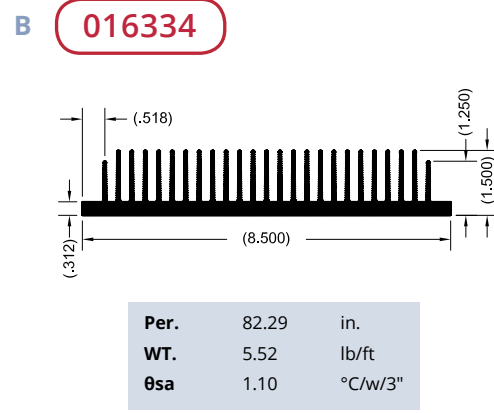
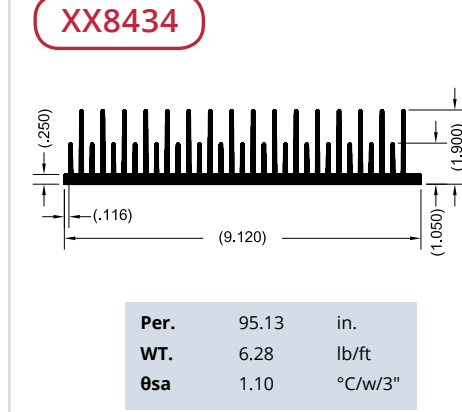
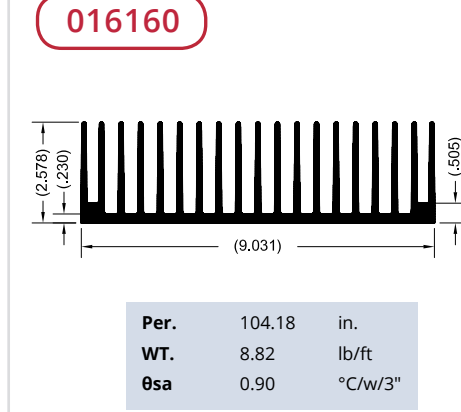
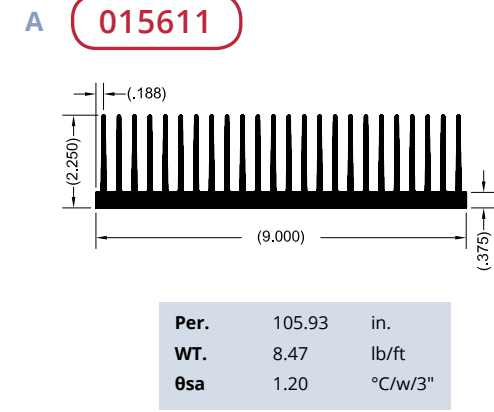
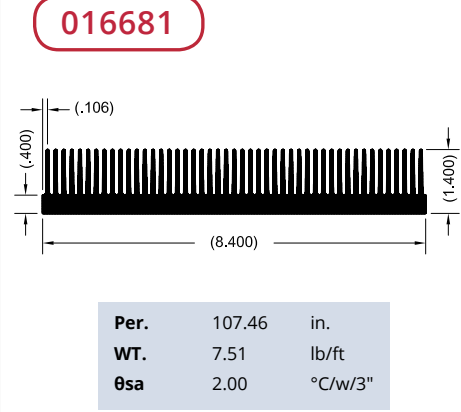
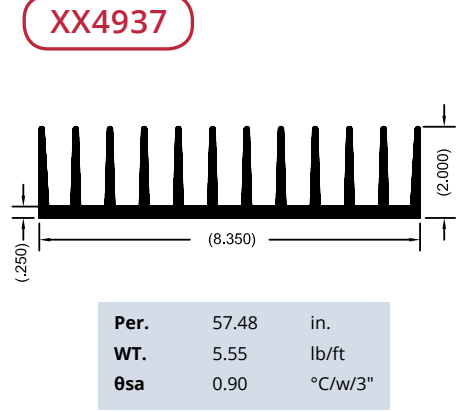
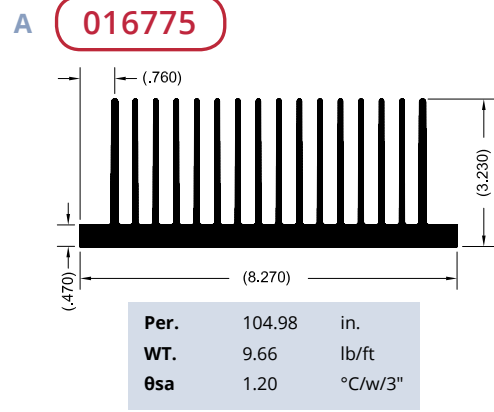

**A 016789**

Per.	73.30	in.
WT.	7.25	lb/ft
θsa	2.10	°C/w/3"

**XX5384**

Per.	98.46	in.
WT.	7.40	lb/ft
θsa	0.75	°C/w/3"

**16758**

Per.	55.45	in.
WT.	5.02	lb/ft
θsa	1.26	°C/w/3"

**A XX2194**

Per.	45.13	in.
WT.	3.24	lb/ft
θsa	1.50	°C/w/3"

**015138**

Per.	53.93	in.
WT.	5.24	lb/ft
θsa	1.30	°C/w/3"

**B XX2021**

Per.	66.42	in.
WT.	5.58	lb/ft
θsa	1.20	°C/w/3"

**XX2017**

Per.	73.22	in.
WT.	6.38	lb/ft
θsa	1.10	°C/w/3"

**XX1703**

Per.	78.03	in.
WT.	6.15	lb/ft
θsa	0.91	°C/w/3"

**B 014236**

Per.	100.80	in.
WT.	15.28	lb/ft
θsa	1.10	°C/w/3"

**XX5772**

Per.	99.79	in.
WT.	15.90	lb/ft
θsa	0.71	°C/w/3"

**C 013849**

Per.	76.21	in.
WT.	7.25	lb/ft
θsa	1.00	°C/w/3"

**015774**

Per.	84.68	in.
WT.	10.74	lb/ft
θsa	0.90	°C/w/3"

**21265**

Per.	100.37	in.
WT.	12.27	lb/ft
θsa	0.70	°C/w/3"

**C XX10087**

Per.	56.77	in.
WT.	5.17	lb/ft
θsa	1.40	°C/w/3"

**XX7253**

Per.	151.74	in.
WT.	13.89	lb/ft
θsa	0.69	°C/w/3"

**D 013953**

Per.	114.78	in.
WT.	11.26	lb/ft
θsa	0.60	°C/w/3"

**21052**

Per.	137.98	in.
WT.	12.10	lb/ft
θsa	0.51	°C/w/3"

**D 17096**

Per.	154.23	in.
WT.	15.86	lb/ft
θsa	0.45	°C/w/3"

**016990**

Per.	75.47	in.
WT.	10.06	lb/ft
θsa	1.30	°C/w/3"

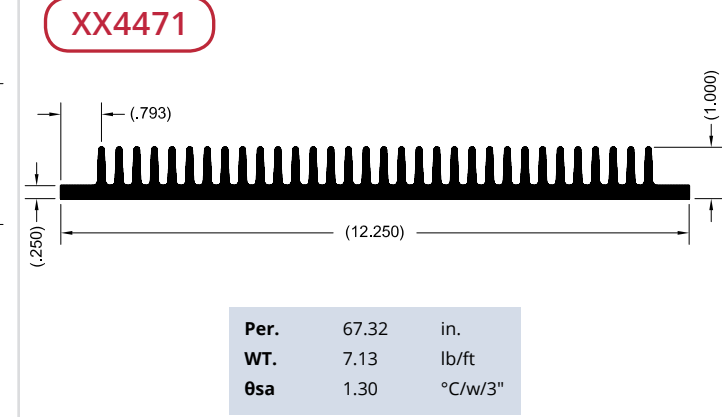
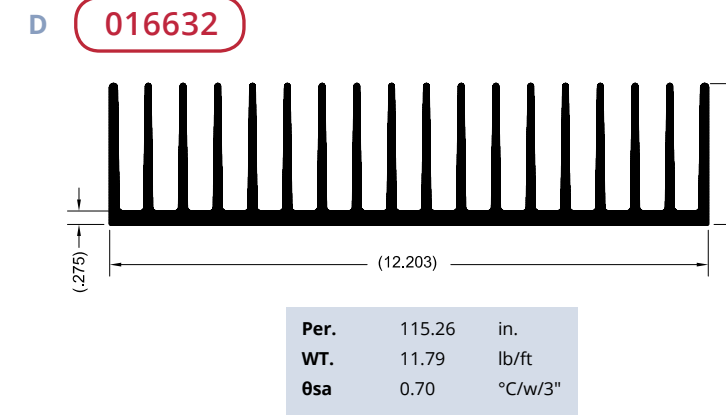
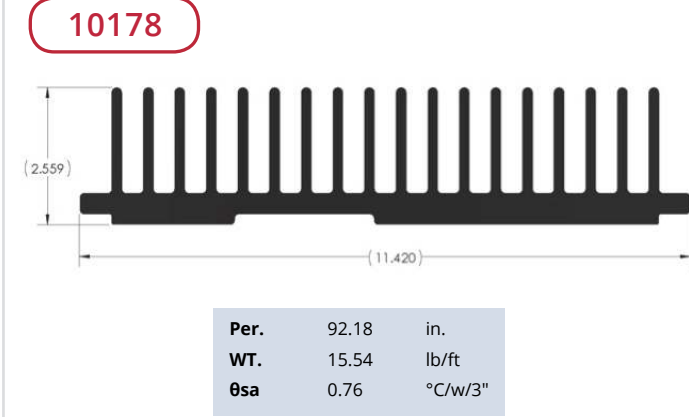
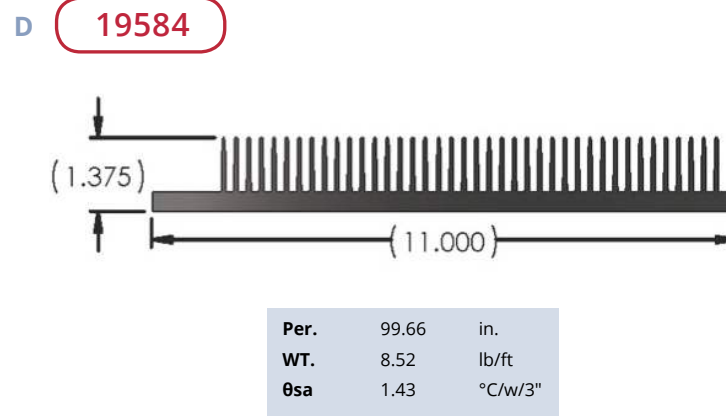
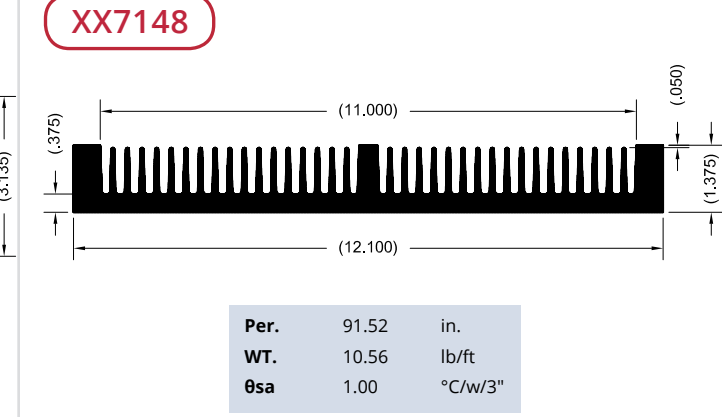
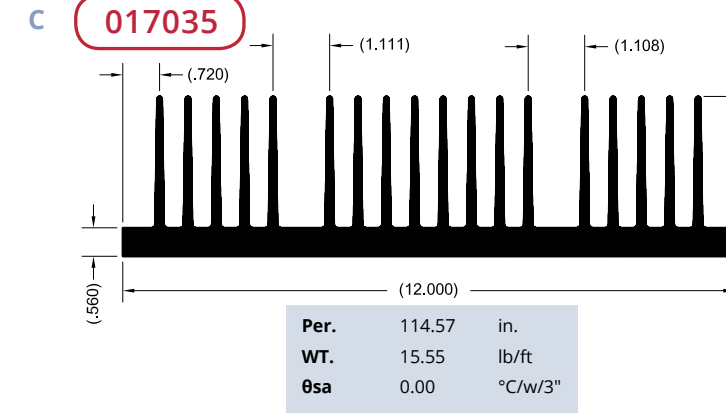
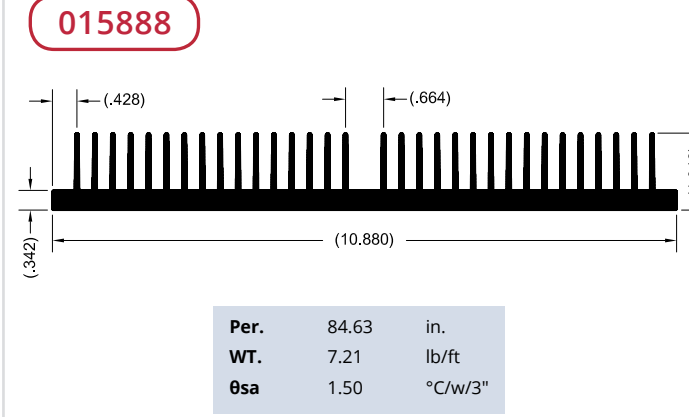
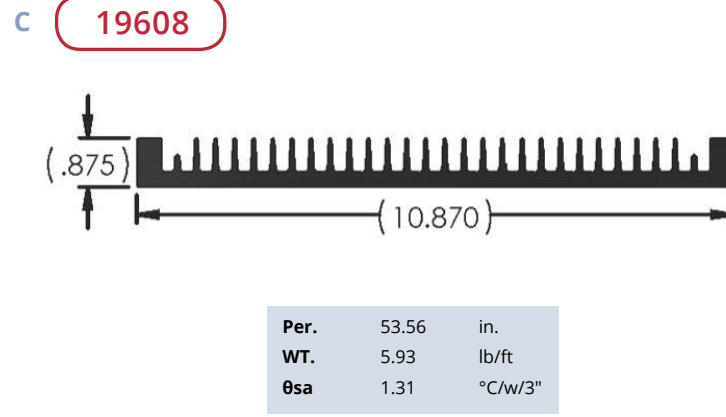
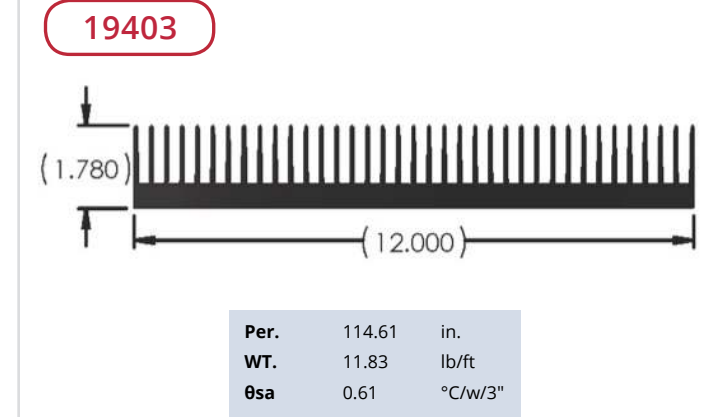
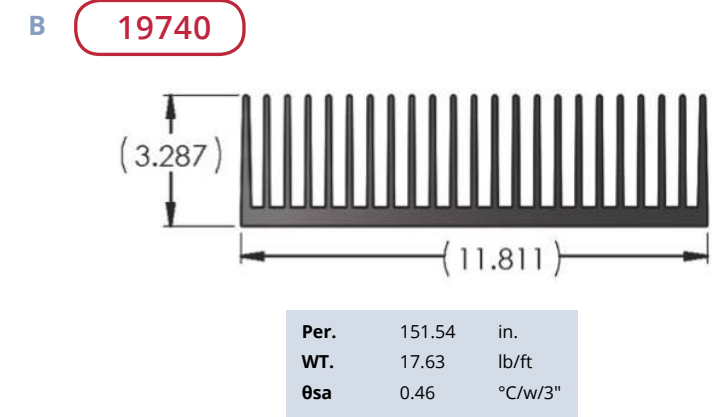
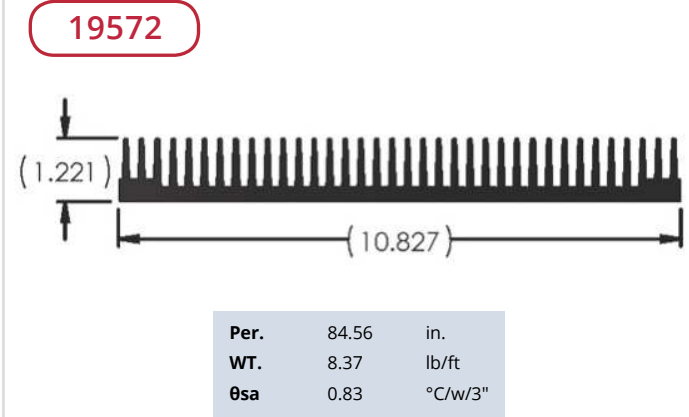
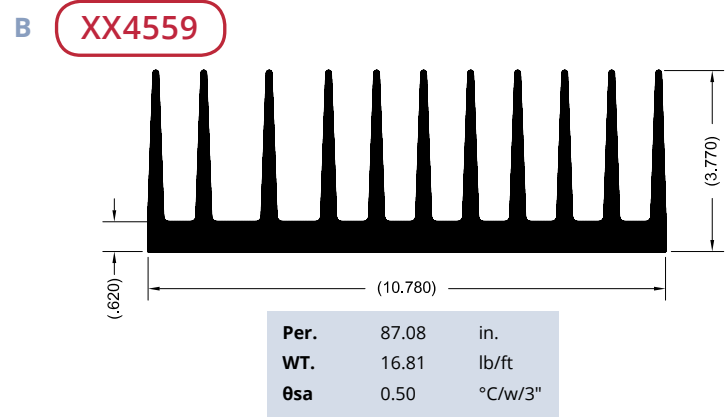
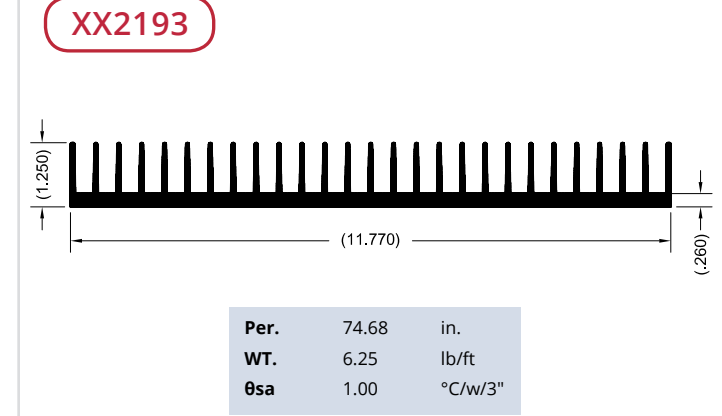
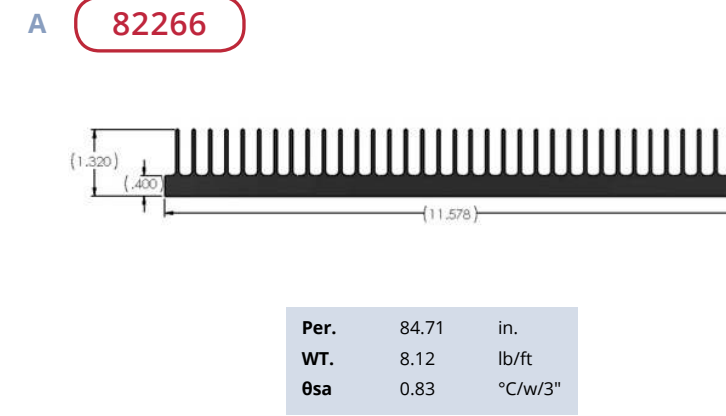
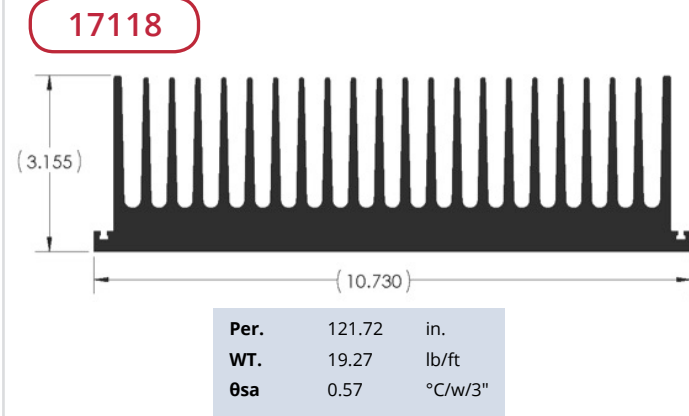
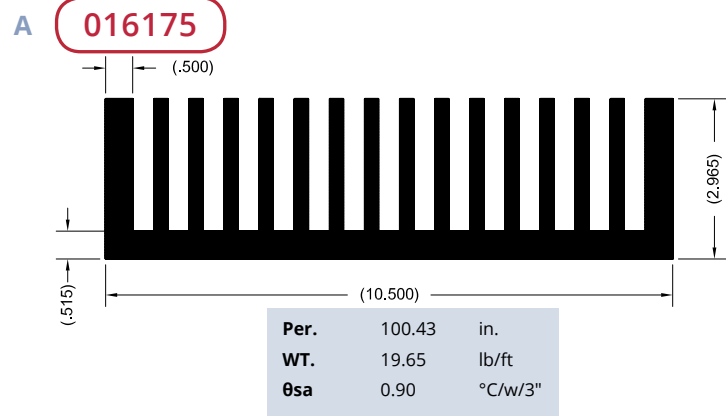

A

**XX2170**

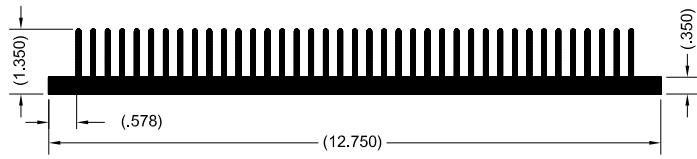

Per.	102.86	in.
WT.	9.07	lb/ft
θsa	0.60	°C/w/3"

**XX2044**

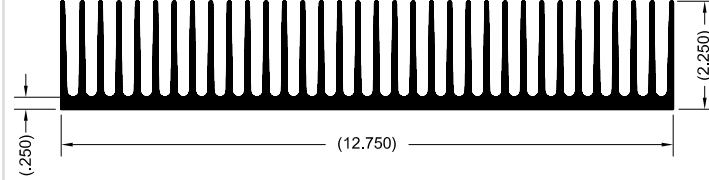

Per.	155.65	in.
WT.	11.00	lb/ft
θsa	0.56	°C/w/3"

B

**XX7214**

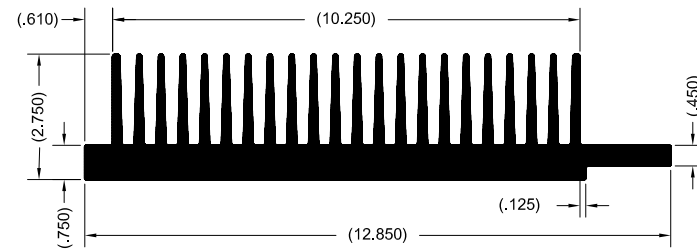

Per.	110.91	in.
WT.	18.71	lb/ft
θsa	0.65	°C/w/3"

**XX5429**

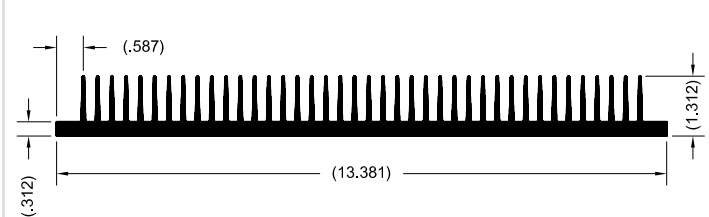

Per.	110.91	in.
WT.	18.71	lb/ft
θsa	0.65	°C/w/3"

C

**013772**

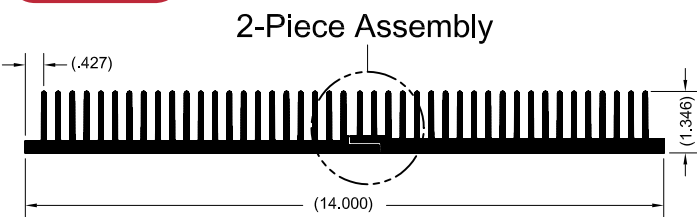

Per.	60.84	in.
WT.	5.08	lb/ft
θsa	0.60	°C/w/3"

**016543**

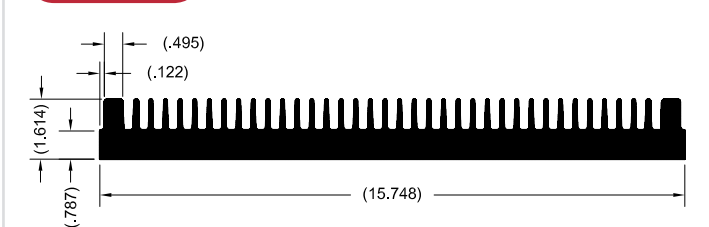

Per.	91.53	in.
WT.	19.20	lb/ft
θsa	1.10	°C/w/3"

D

**XX2016**

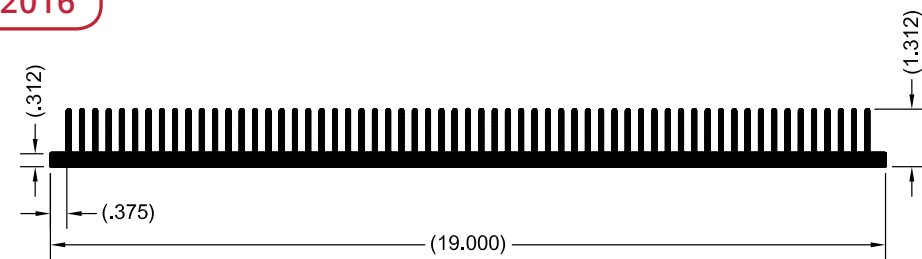

Per.	110.91	in.
WT.	18.71	lb/ft
θsa	0.65	°C/w/3"

A

**19081 & 19082**

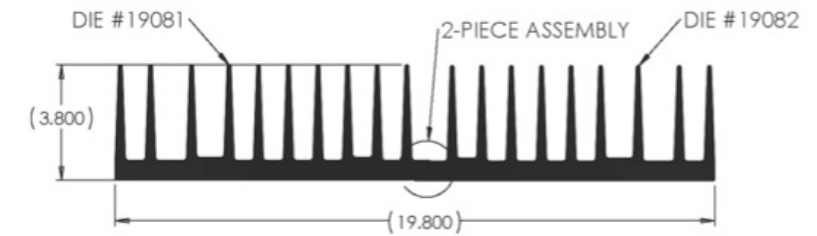

Per.	153.20	in.
WT.	30.19	lb/ft
θsa	0.46	°C/w/3"

B

**009350**

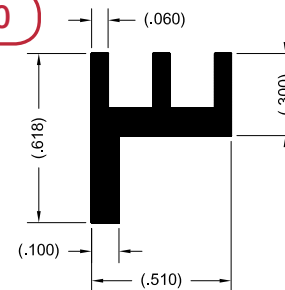

Per.	3.07	in.
WT.	0.14	lb/ft
θsa	22.80	°C/w/3"

**012732**

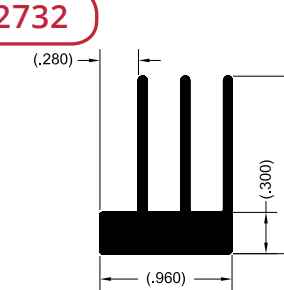

Per.	8.22	in.
WT.	0.56	lb/ft
θsa	6.50	°C/w/3"

**009304**

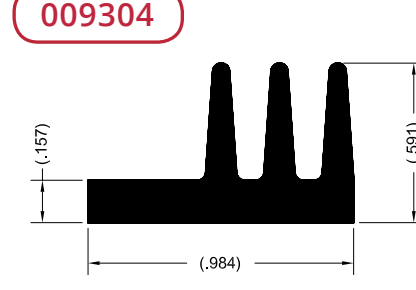

Per.	4.89	in.
WT.	0.33	lb/ft
θsa	14.30	°C/w/3"

C

**009893**

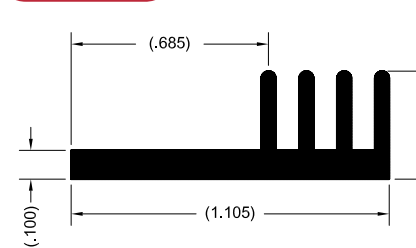

Per.	4.61	in.
WT.	0.20	lb/ft
θsa	15.20	°C/w/3"

**013691**

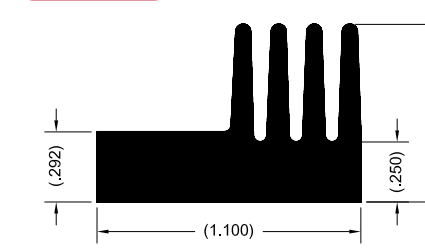

Per.	6.31	in.
WT.	0.52	lb/ft
θsa	11.10	°C/w/3"

**XX5269**

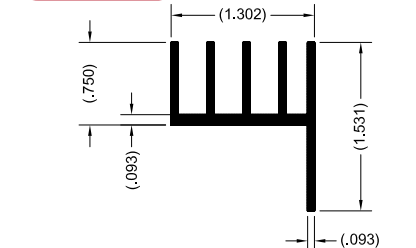

Per.	10.92	in.
WT.	0.48	lb/ft
θsa	7.30	°C/w/3"

D

**014755**

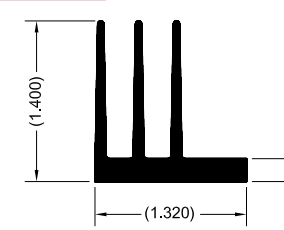

Per.	9.97	in.
WT.	0.63	lb/ft
θsa	5.70	°C/w/3"

**XX8627**

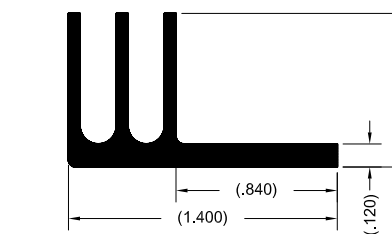

Per.	6.92	in.
WT.	0.36	lb/ft
θsa	7.00	°C/w/3"

**006248**

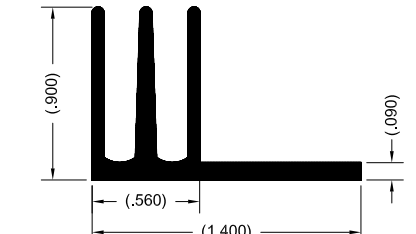

Per.	7.61	in.
WT.	0.37	lb/ft
θsa	9.20	°C/w/3"



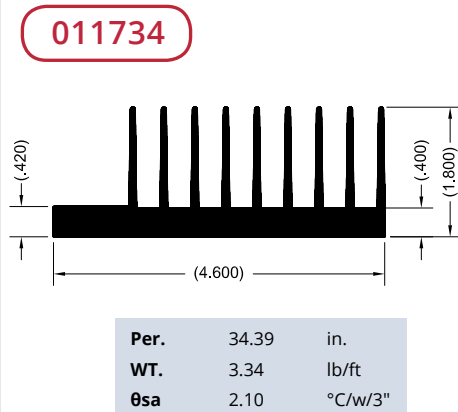
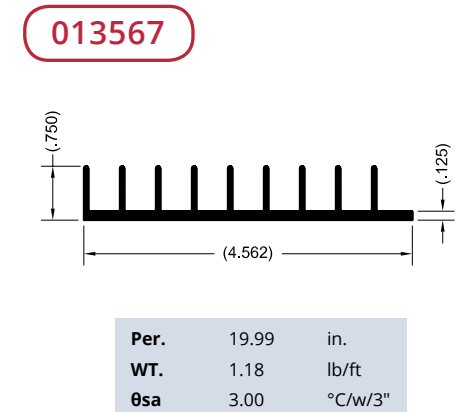
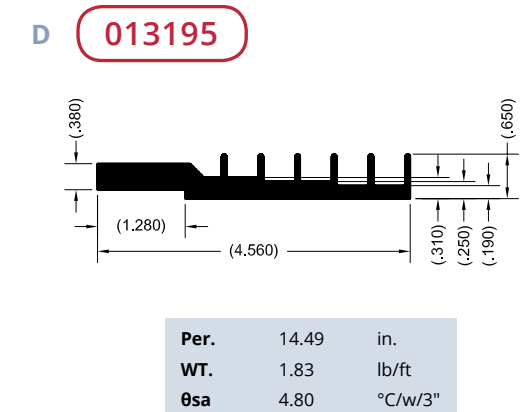
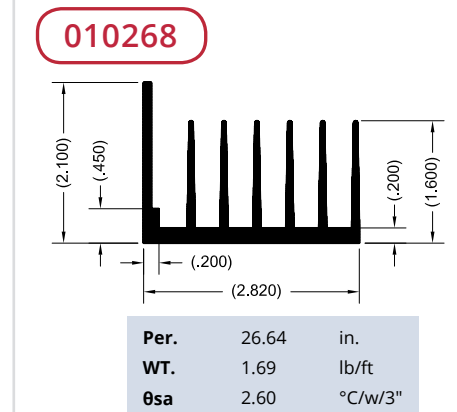
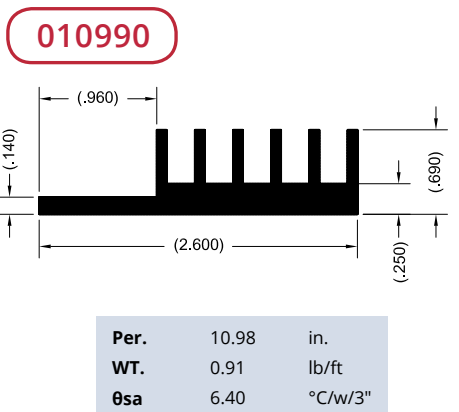
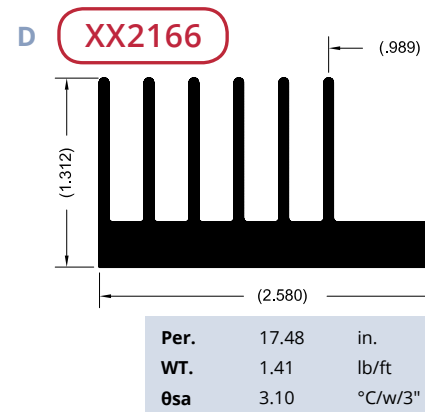
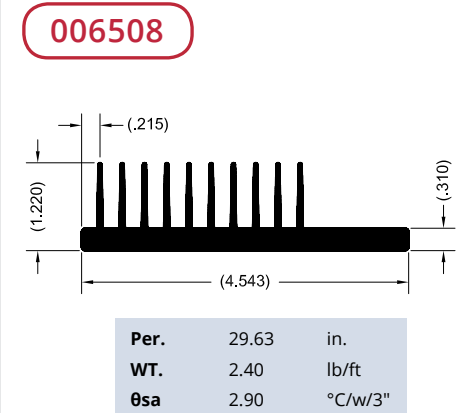
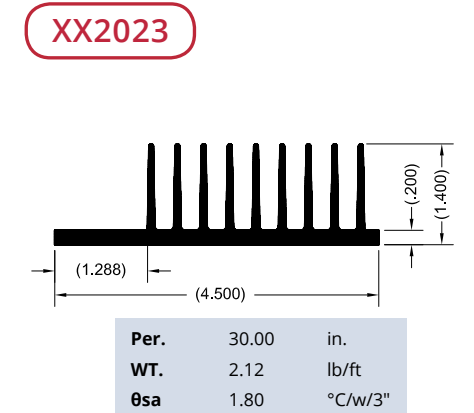
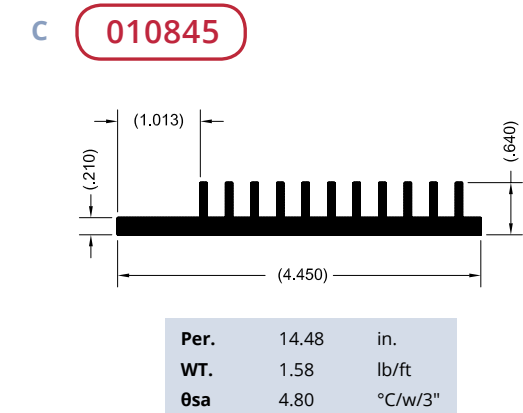
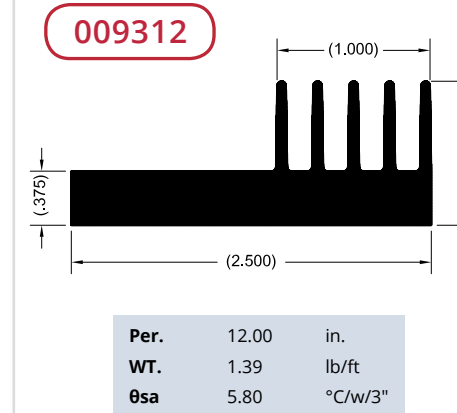
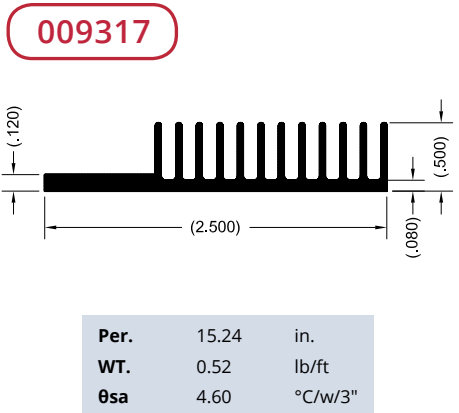
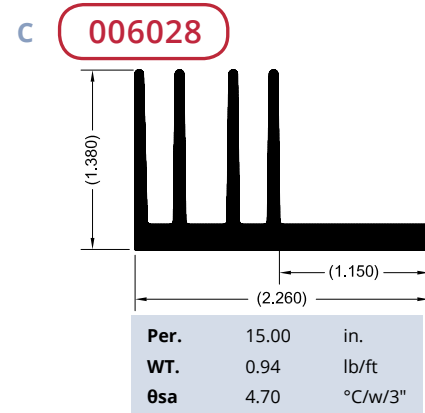
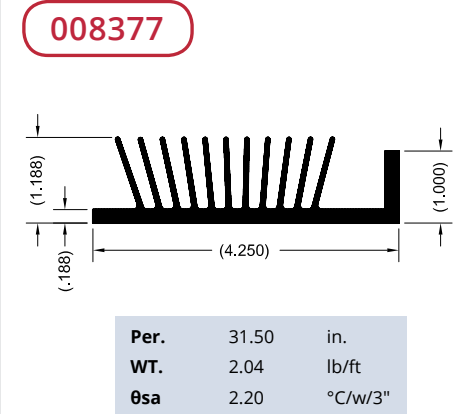
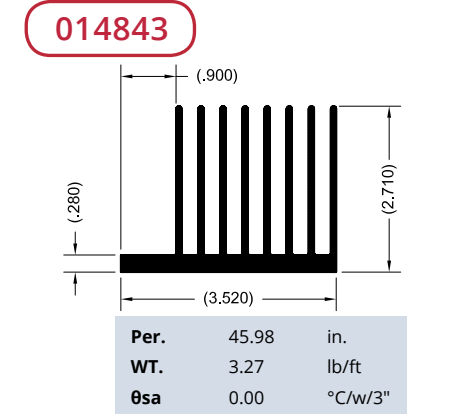
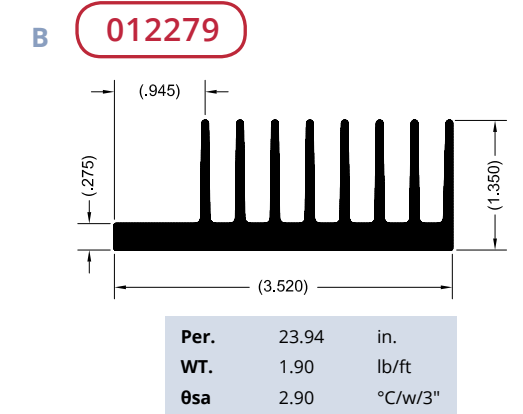
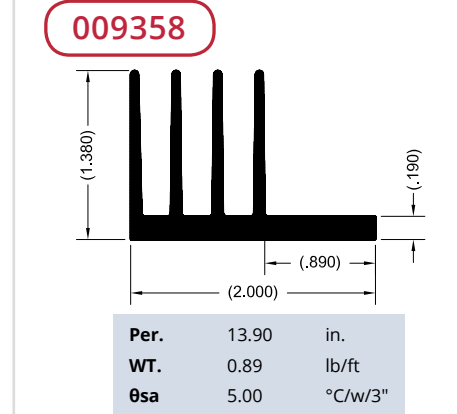
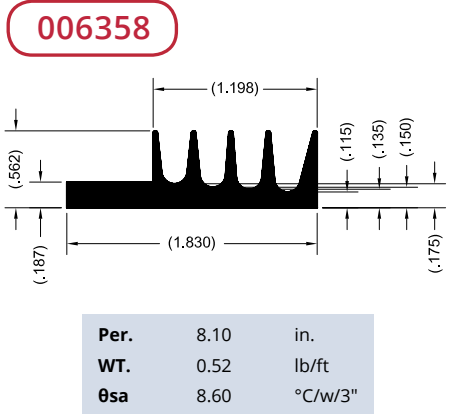
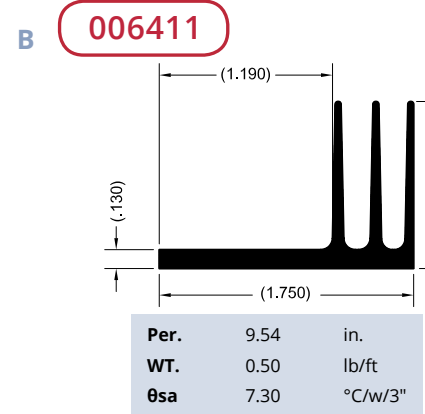
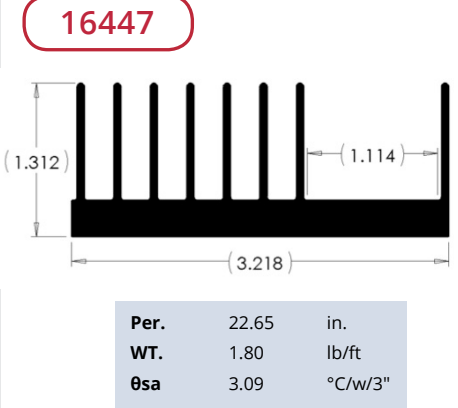
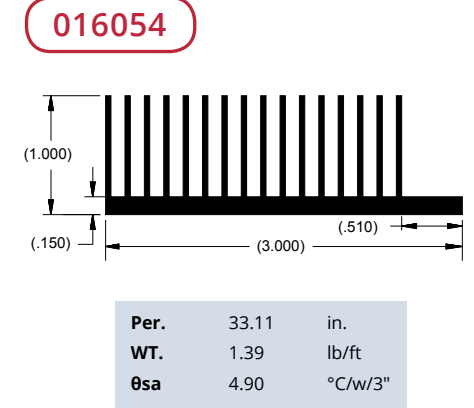
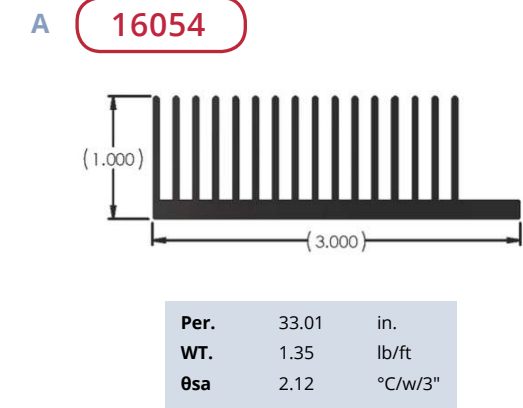
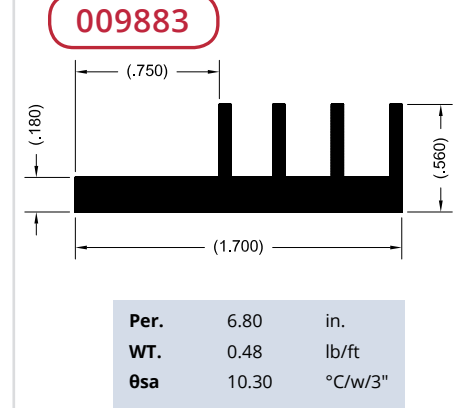
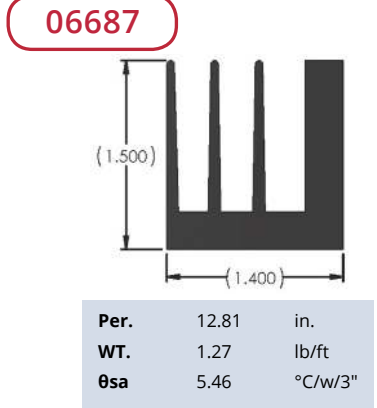
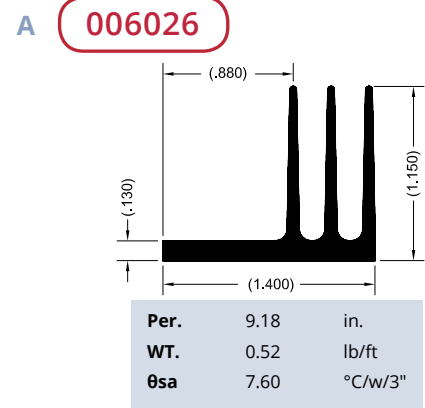

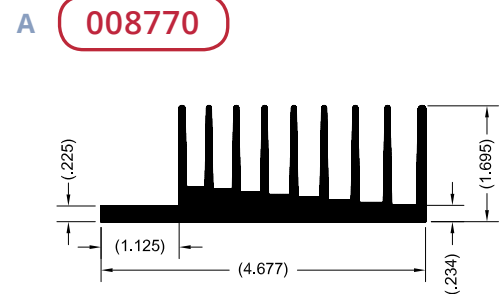

Per.	32.75	in.
WT.	3.04	lb/ft
θsa	2.10	°C/w/3"

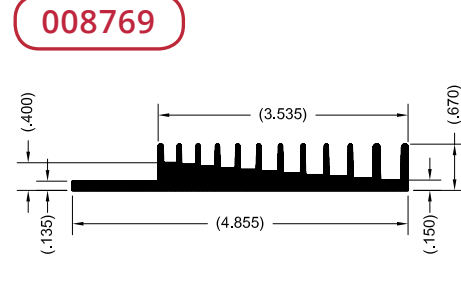

Per.	19.24	in.
WT.	1.65	lb/ft
θsa	3.60	°C/w/3"

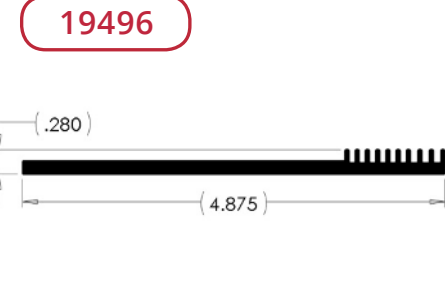

Per.	12.75	in.
WT.	0.93	lb/ft
θsa	5.48	°C/w/3"

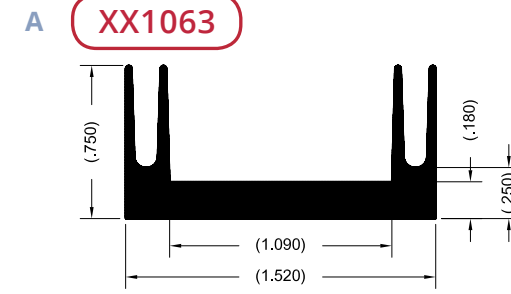

Per.	7.45	in.
WT.	0.46	lb/ft
θsa	5.10	°C/w/3"

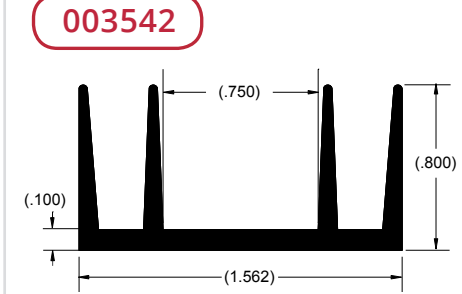

Per.	8.95	in.
WT.	0.41	lb/ft
θsa	7.80	°C/w/3"

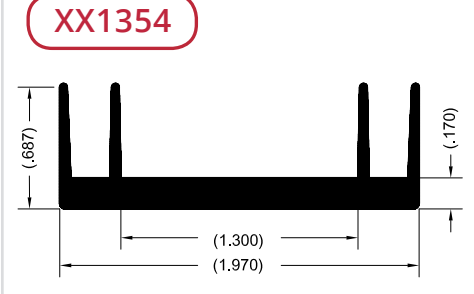

Per.	8.24	in.
WT.	0.52	lb/ft
θsa	4.30	°C/w/3"

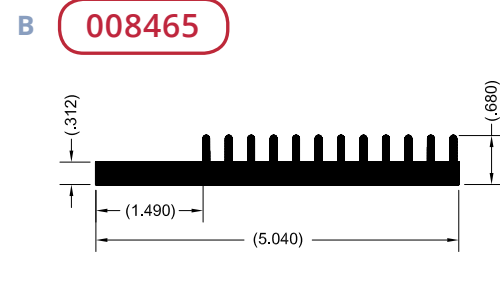

Per.	19.54	in.
WT.	2.34	lb/ft
θsa	3.60	°C/w/3"

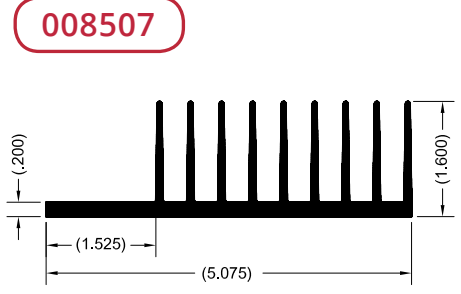

Per.	35.08	in.
WT.	2.43	lb/ft
θsa	2.60	°C/w/3"

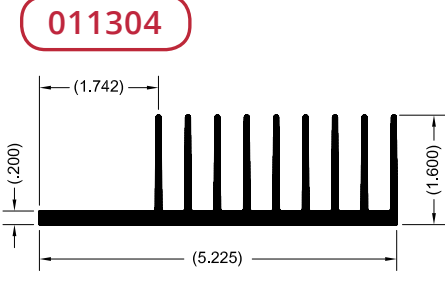

Per.	34.60	in.
WT.	2.37	lb/ft
θsa	2.00	°C/w/3"

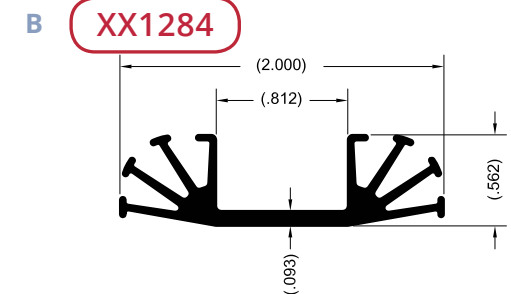

Per.	9.96	in.
WT.	0.37	lb/ft
θsa	6.50	°C/w/3"

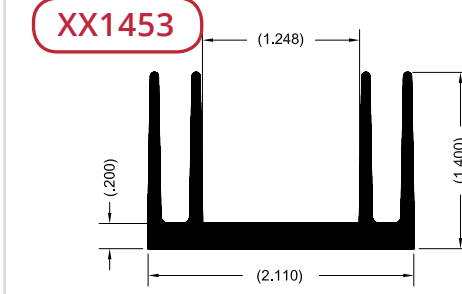

Per.	13.86	in.
WT.	1.00	lb/ft
θsa	3.50	°C/w/3"

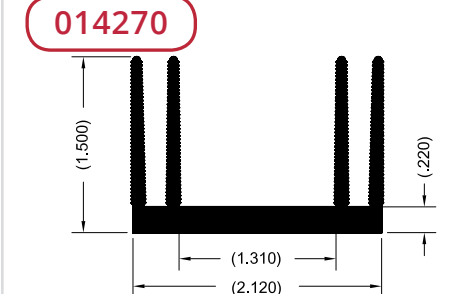

Per.	22.50	in.
WT.	1.07	lb/ft
θsa	3.10	°C/w/3"

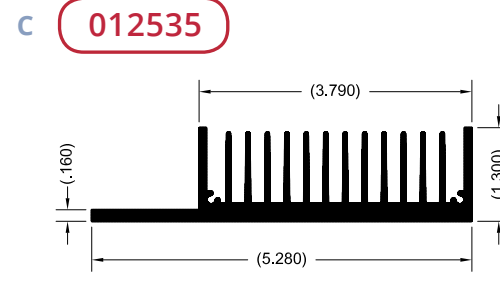

Per.	39.12	in.
WT.	2.54	lb/ft
θsa	1.80	°C/w/3"

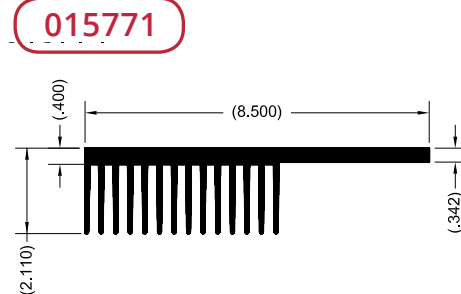

Per.	64.44	in.
WT.	6.35	lb/ft
θsa	0.00	°C/w/3"

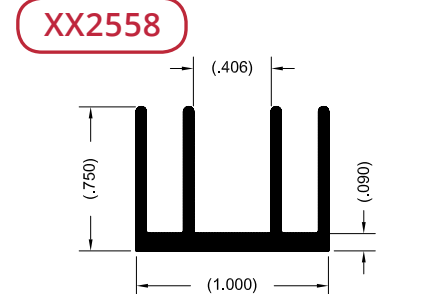

Per.	7.46	in.
WT.	0.27	lb/ft
θsa	8.00	°C/w/3"

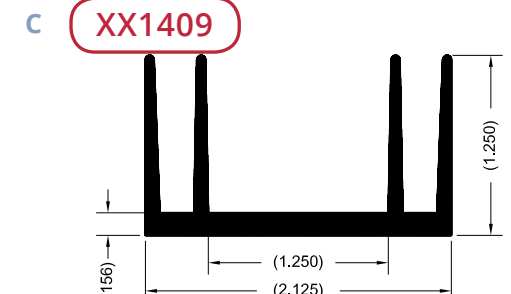

Per.	13.05	in.
WT.	0.81	lb/ft
θsa	3.80	°C/w/3"

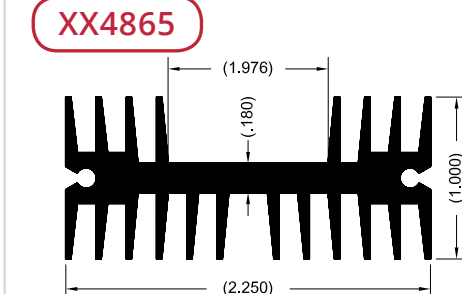

Per.	20.15	in.
WT.	1.02	lb/ft
θsa	3.50	°C/w/3"

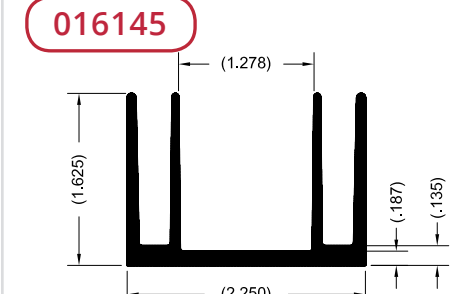

Per.	16.17	in.
WT.	1.01	lb/ft
θsa	3.70	°C/w/3"

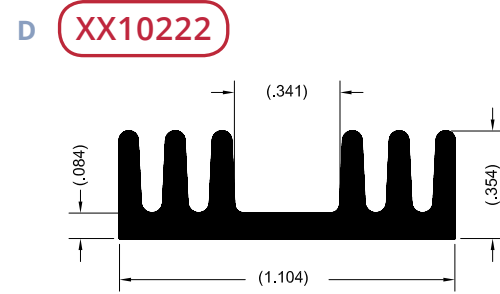

Per.	5.15	in.
WT.	0.99	lb/ft
θsa	10.00	°C/w/3"

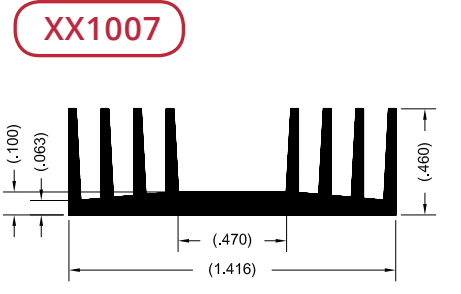

Per.	8.88	in.
WT.	0.29	lb/ft
θsa	6.40	°C/w/3"

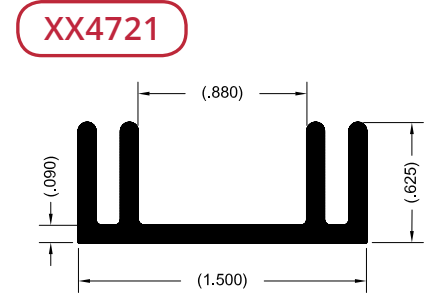

Per.	7.23	in.
WT.	0.39	lb/ft
θsa	10.30	°C/w/3"

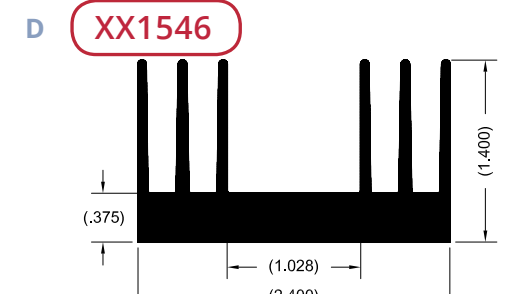

Per.	17.49	in.
WT.	1.61	lb/ft
θsa	3.70	°C/w/3"

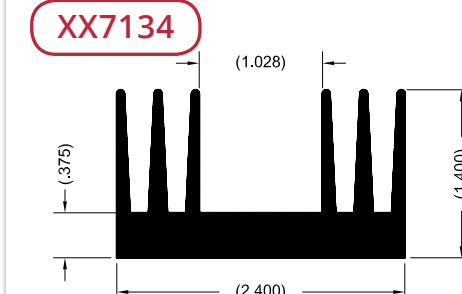

Per.	17.32	in.
WT.	1.76	lb/ft
θsa	2.00	°C/w/3"

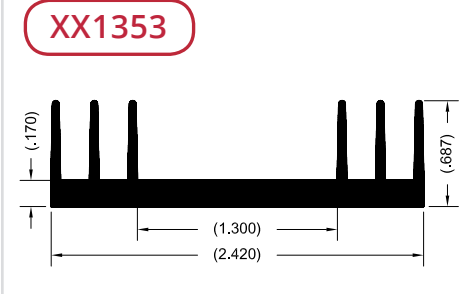

Per.	11.16	in.
WT.	0.68	lb/ft
θsa	4.00	°C/w/3"

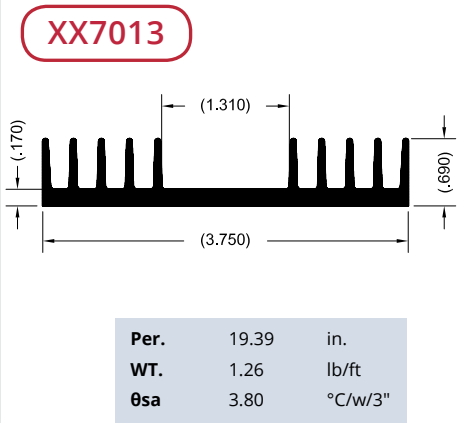
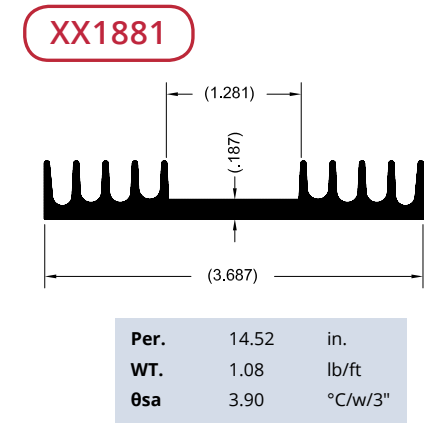
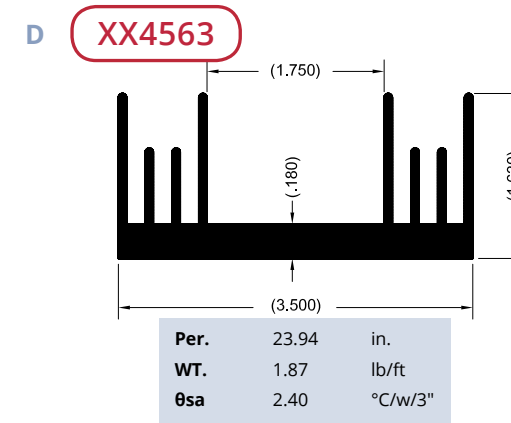
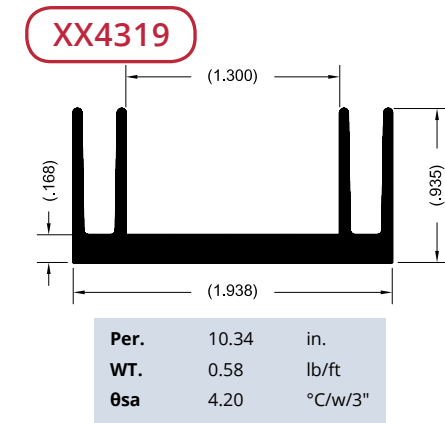
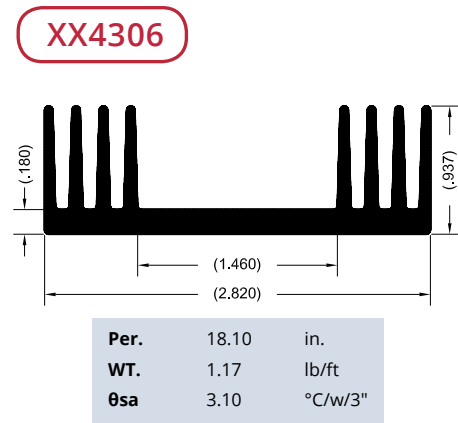
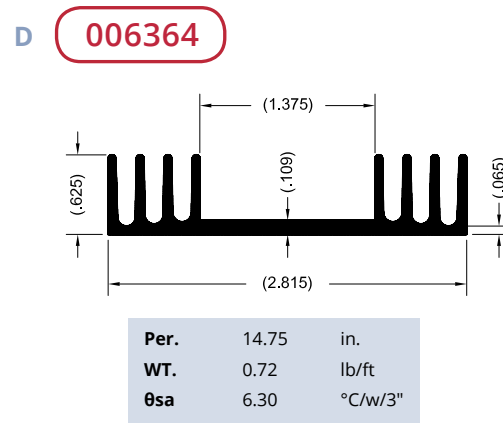
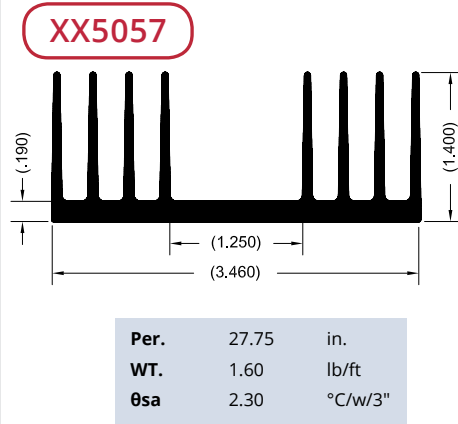
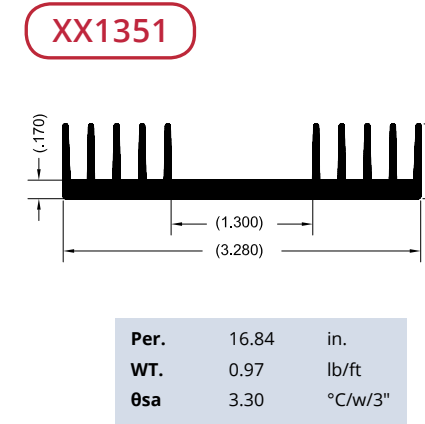
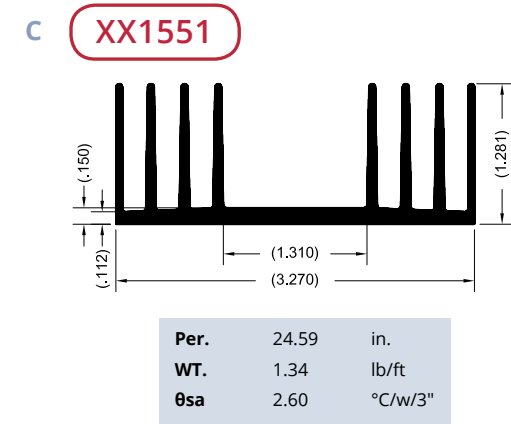
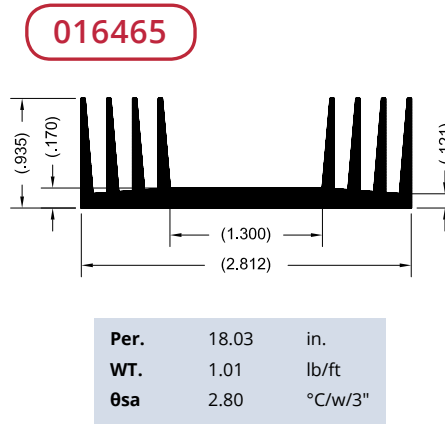
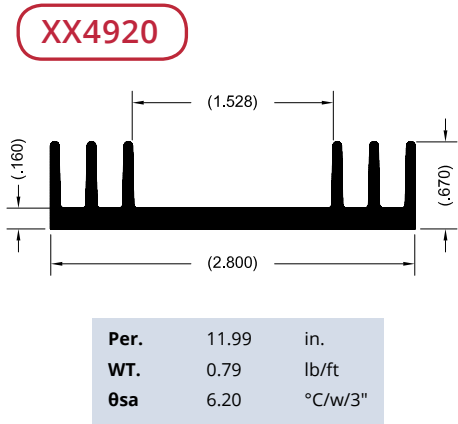
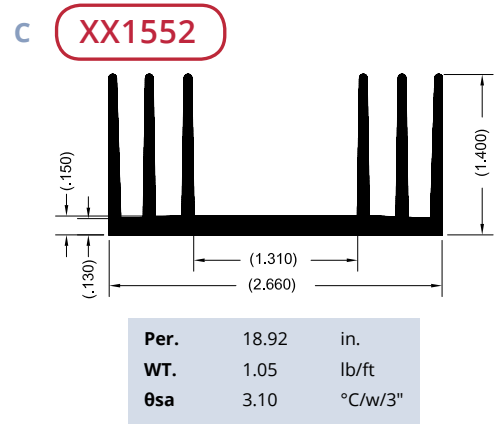
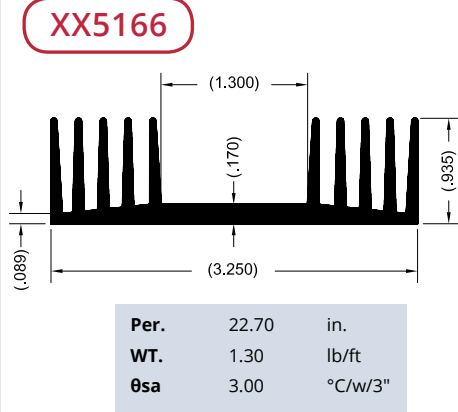
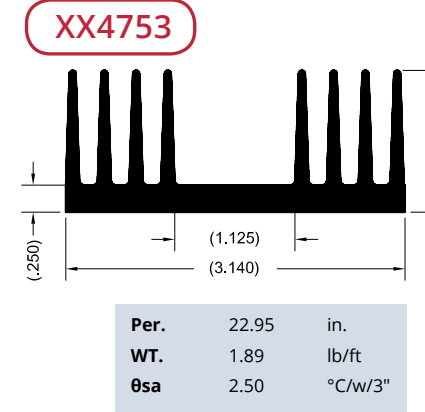
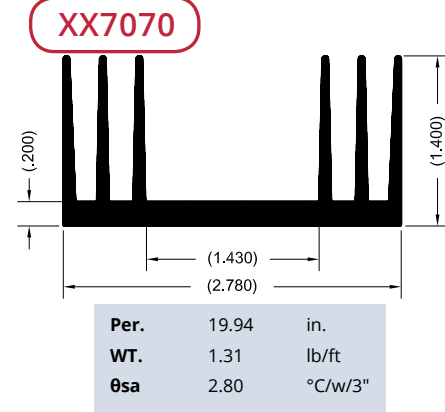
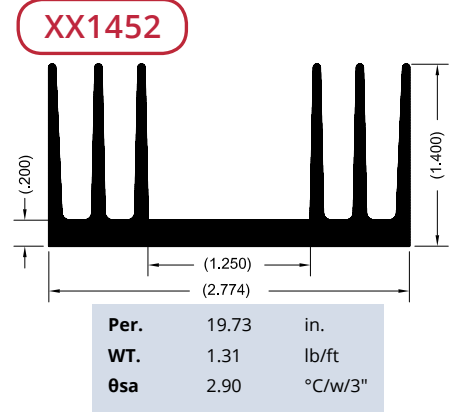
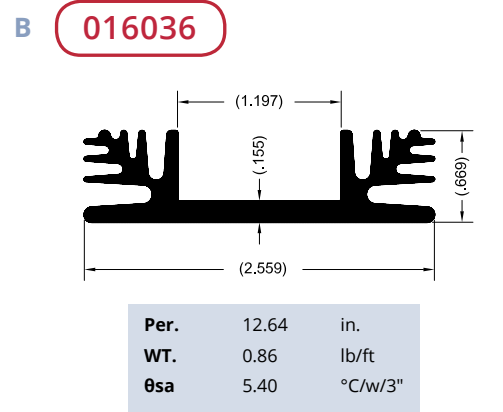
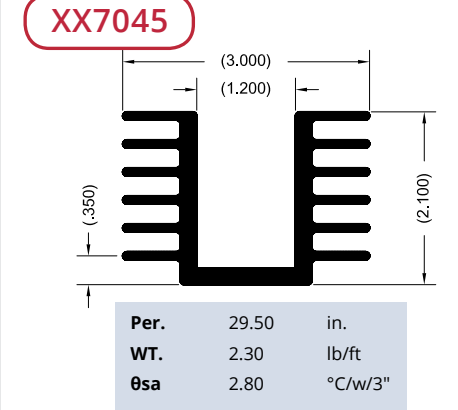
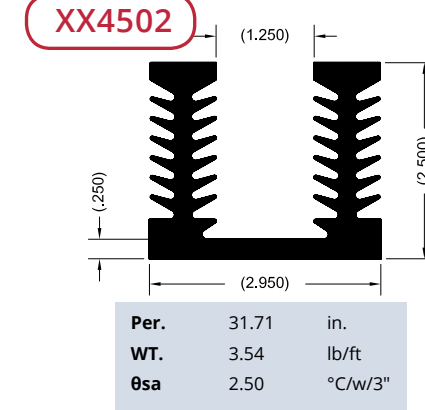
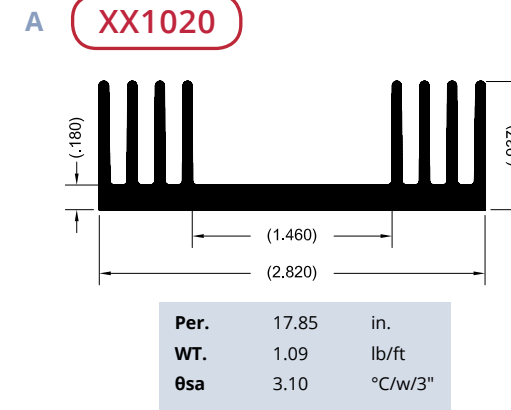
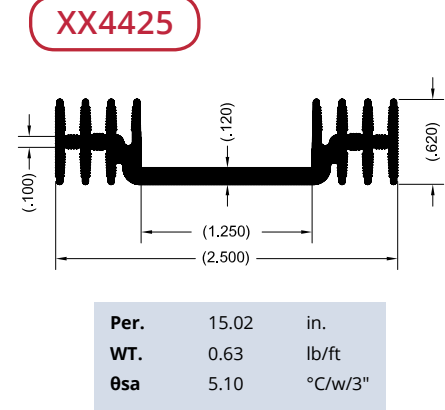
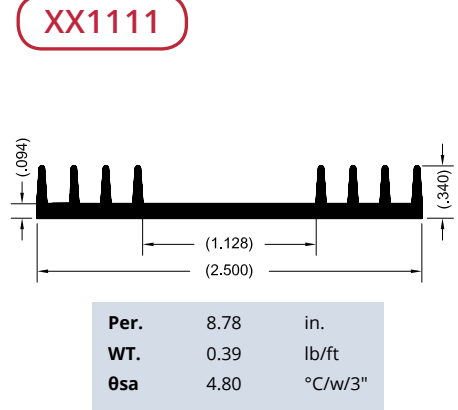
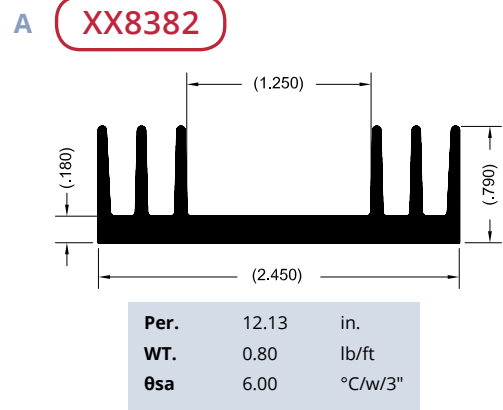

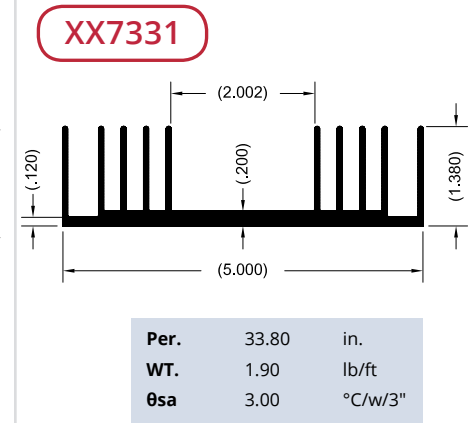
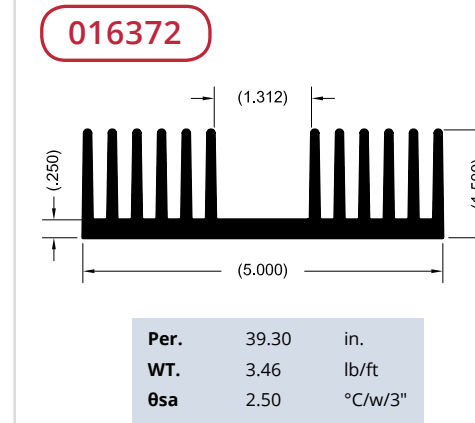
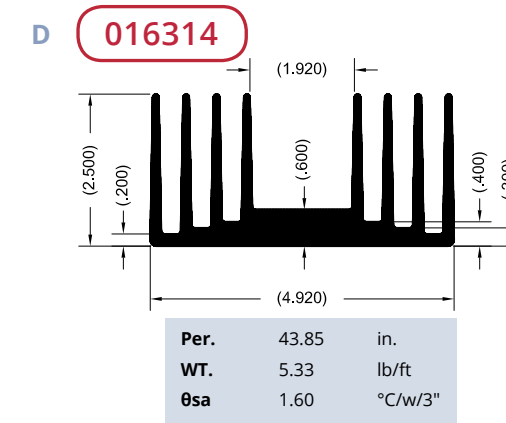
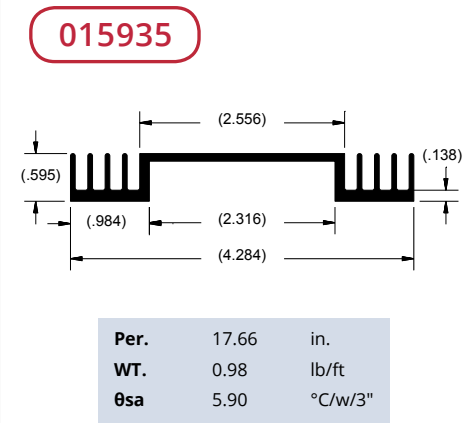
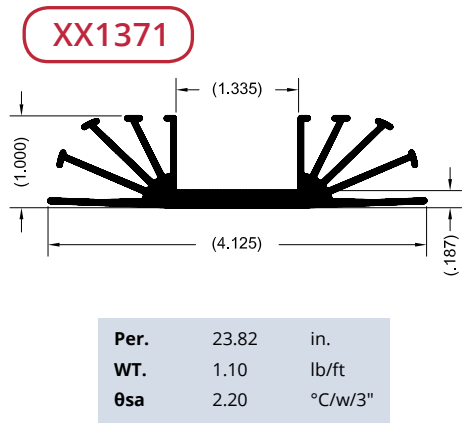
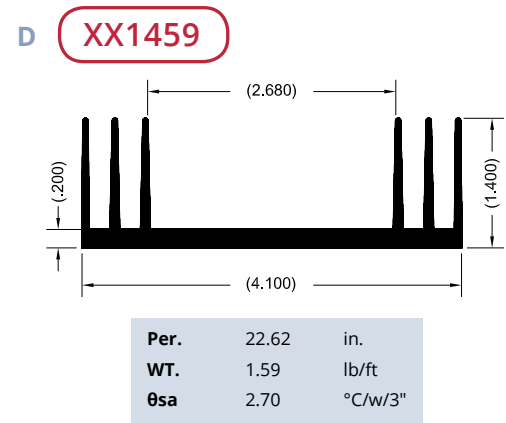
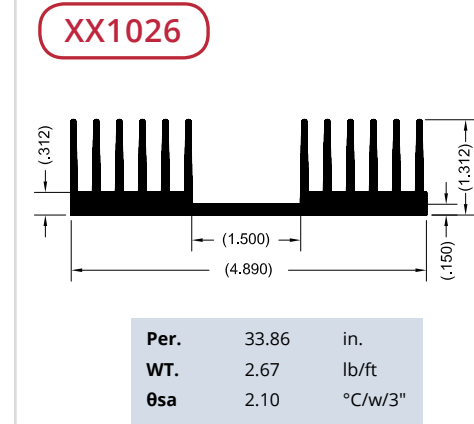
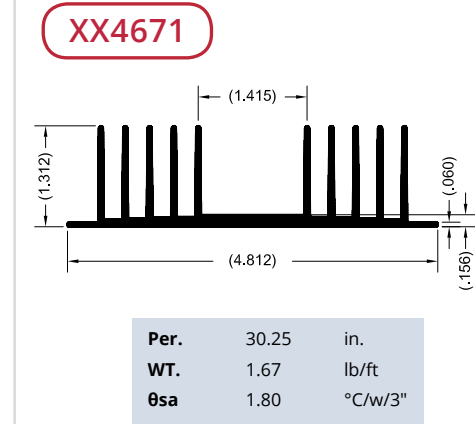
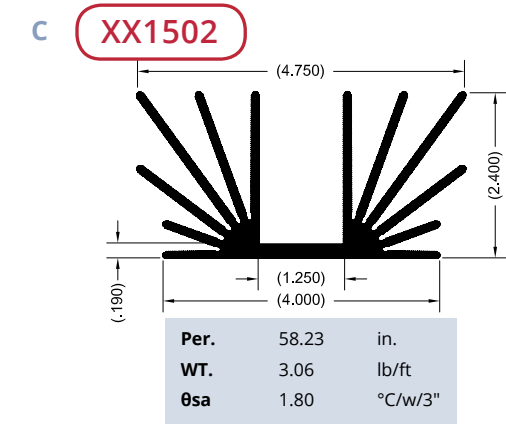
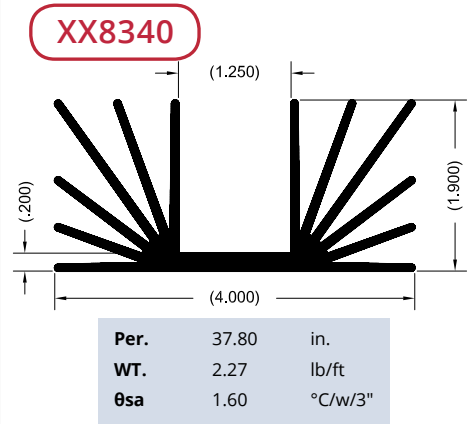
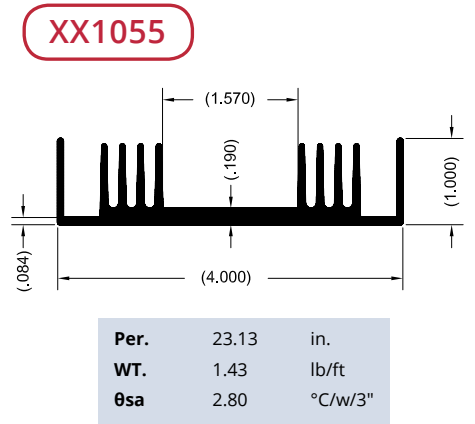
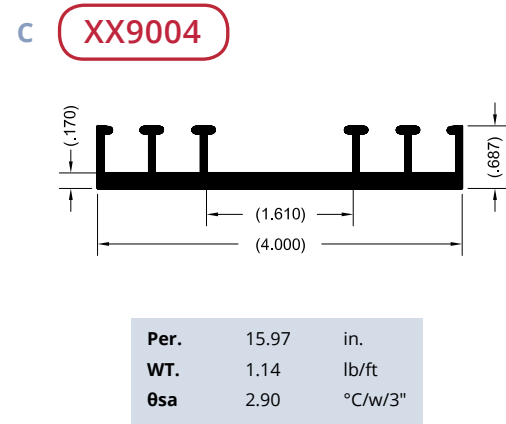
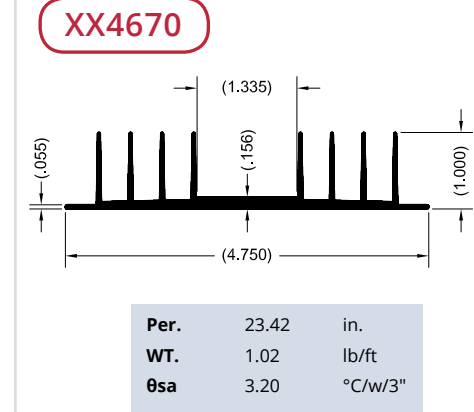
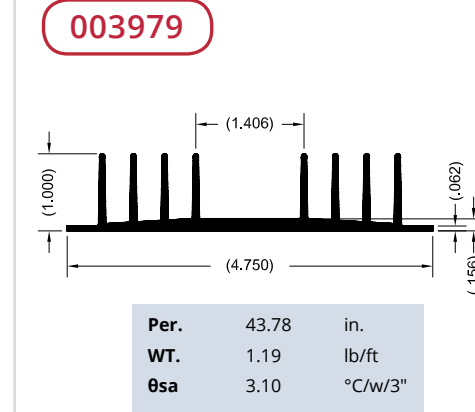
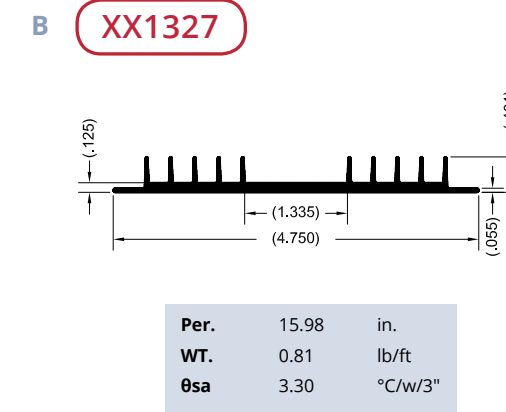
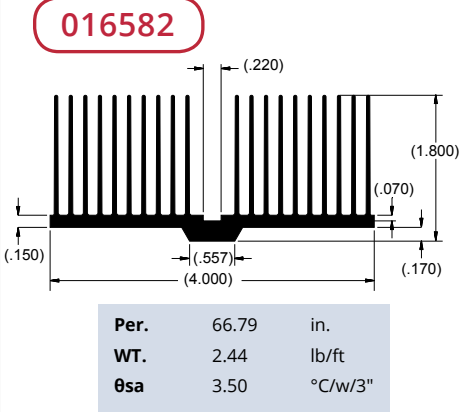
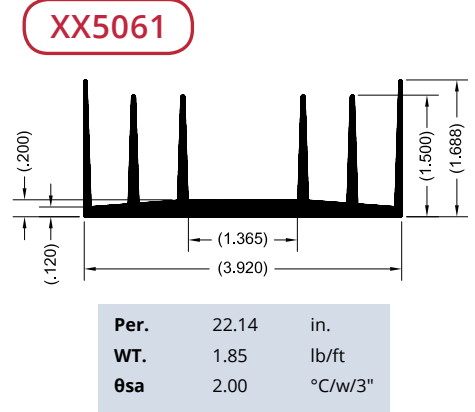
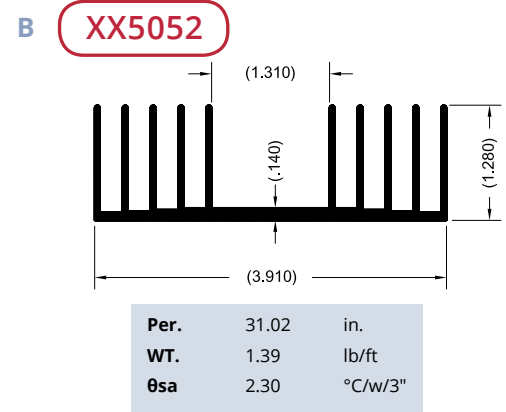
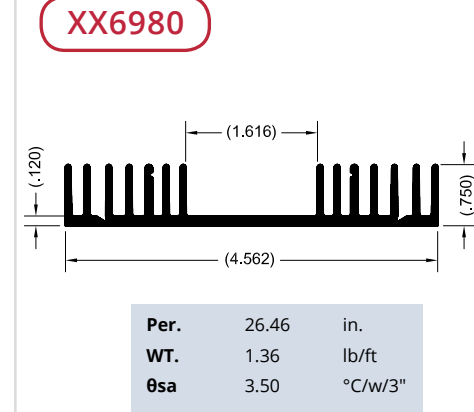
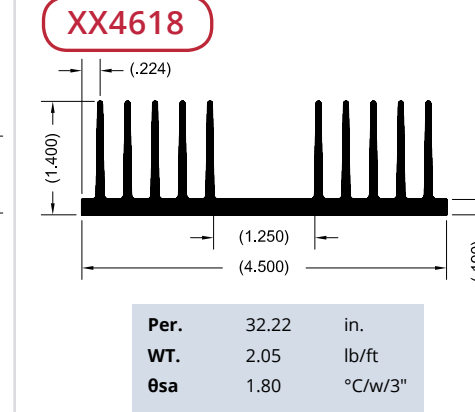
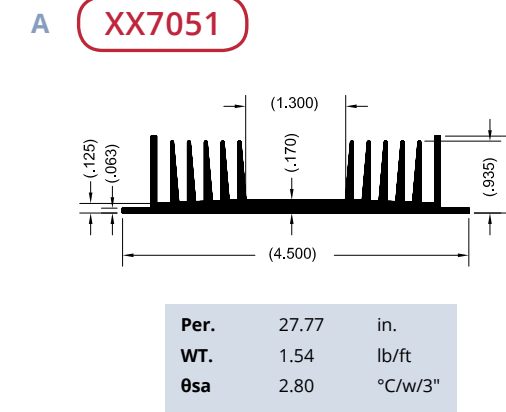
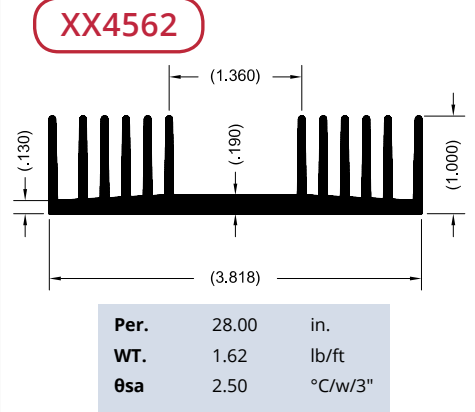
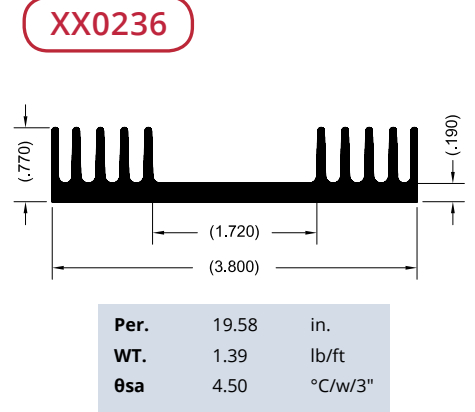
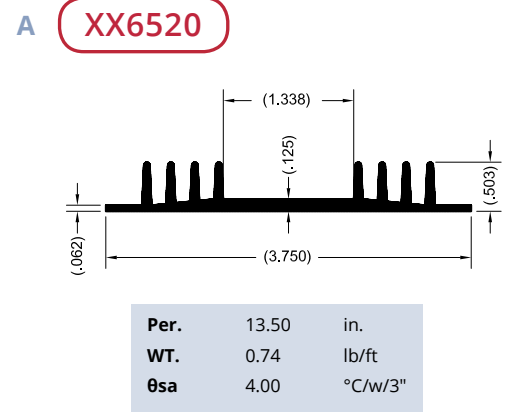



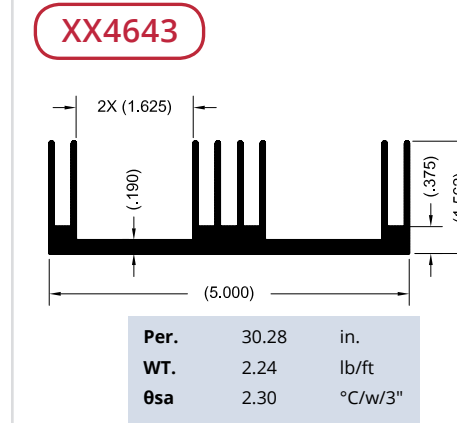
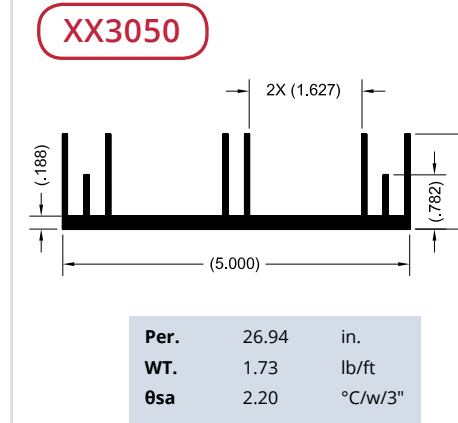
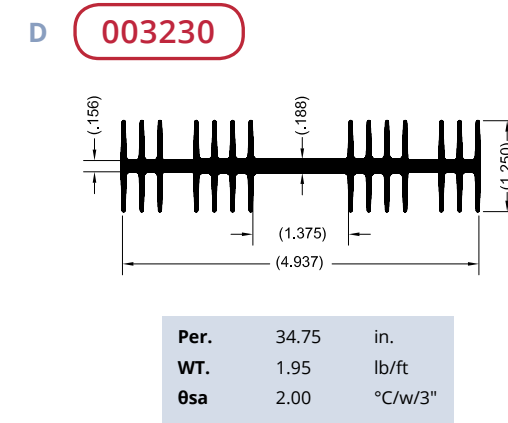
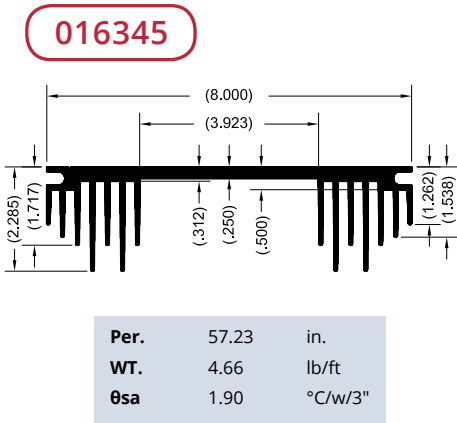
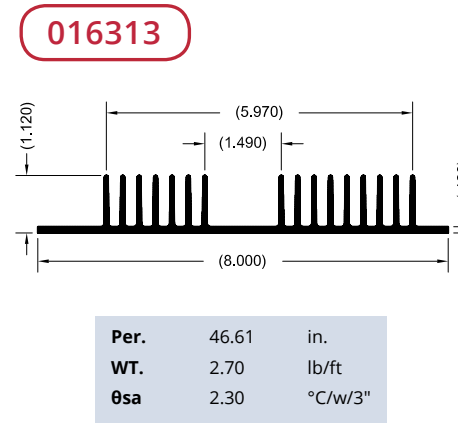
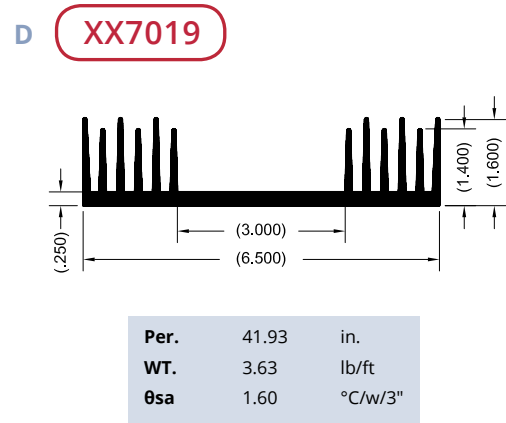
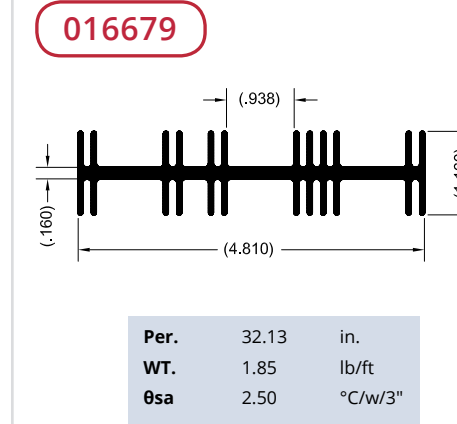
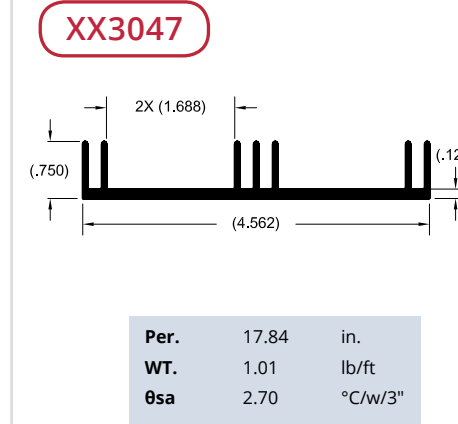
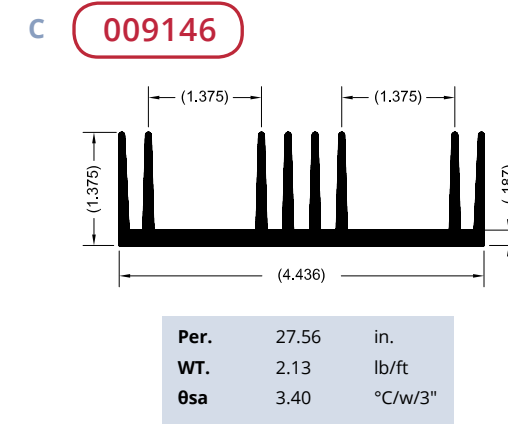
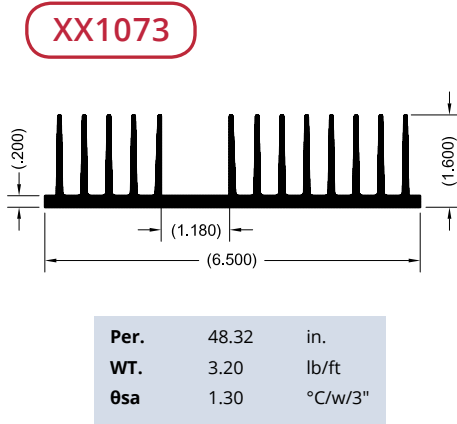
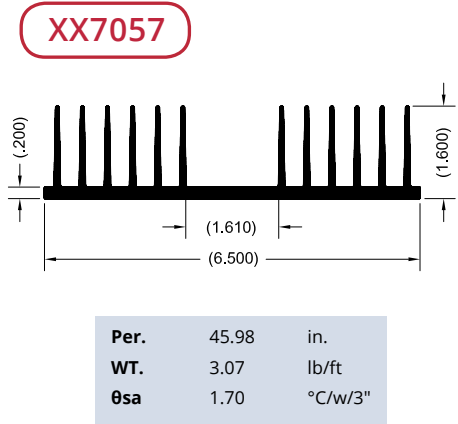
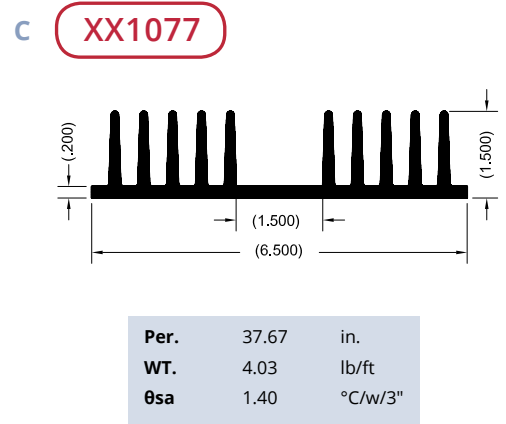
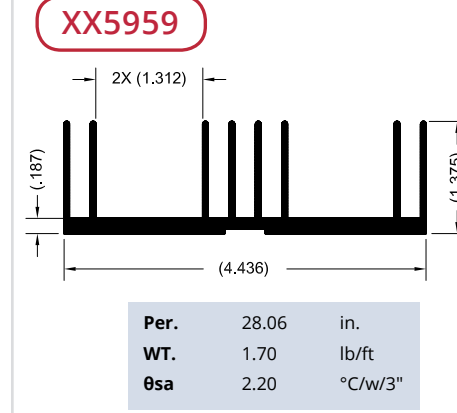
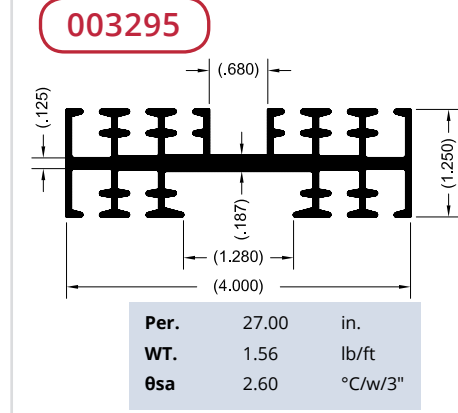
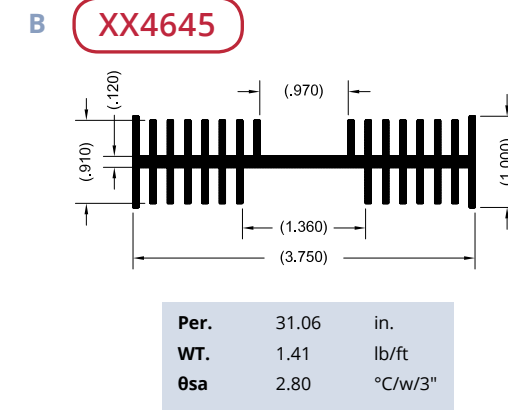
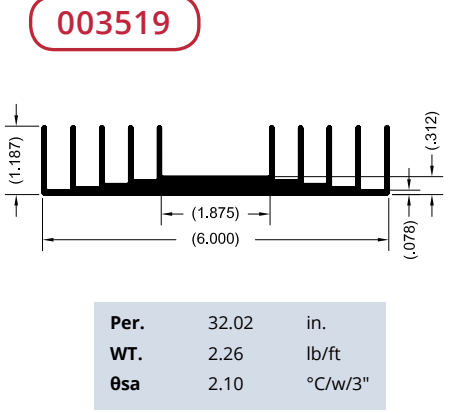
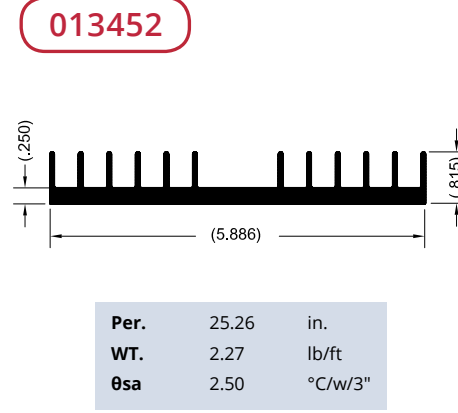
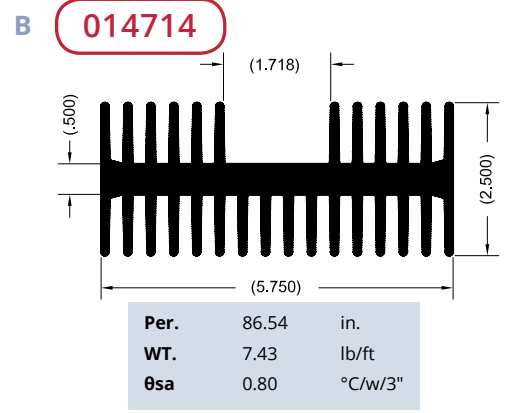
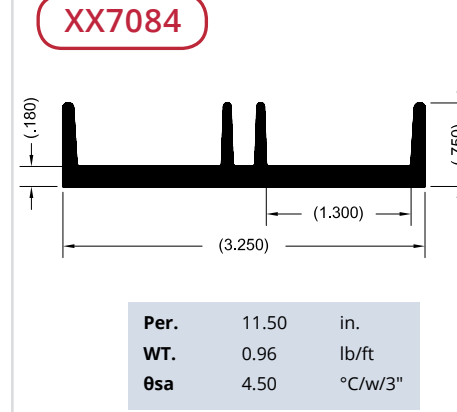
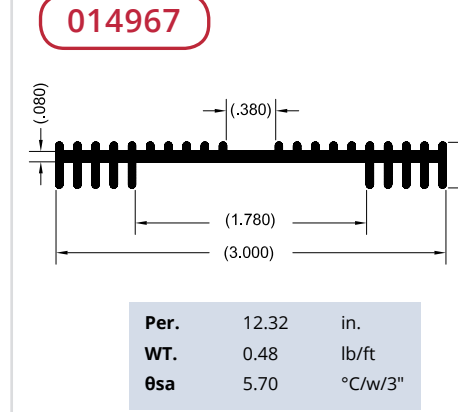
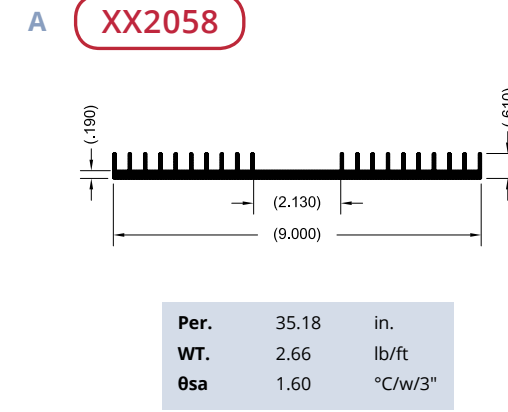
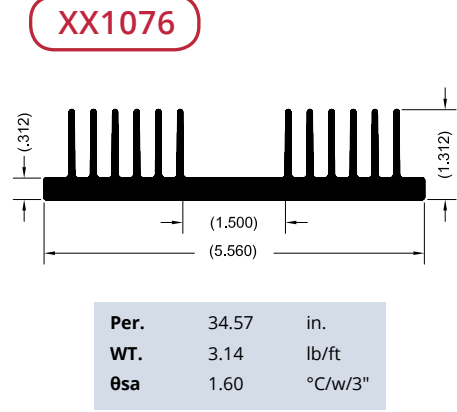
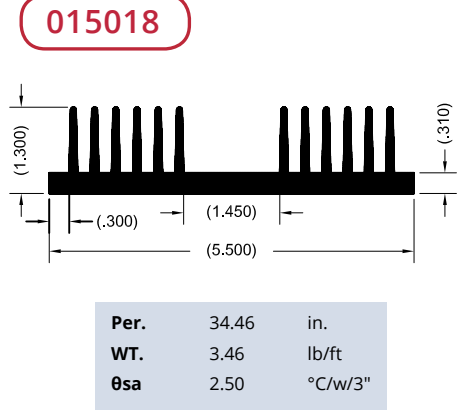
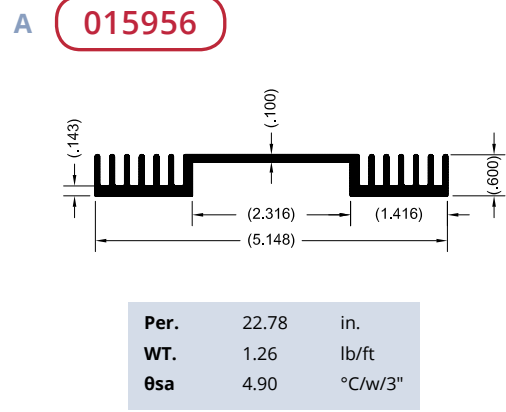

**A XX9014**

Per.	26.40	in.
WT.	1.99	lb/ft
θsa	2.20	°C/w/3"

**007999**

Per.	31.80	in.
WT.	2.04	lb/ft
θsa	2.26	°C/w/3"

**XX4917**

Per.	35.65	in.
WT.	2.47	lb/ft
θsa	1.25	°C/w/3"

**A 014324**

Per.	53.57	in.
WT.	3.94	lb/ft
θsa	1.30	°C/w/3"

**016333**

Per.	48.03	in.
WT.	4.08	lb/ft
θsa	2.20	°C/w/3"

**XX3002**

Per.	72.21	in.
WT.	4.83	lb/ft
θsa	1.10	°C/w/3"

**B 04842**

Per.	28.36	in.
WT.	1.68	lb/ft
θsa	2.47	°C/w/3"

**XX4617**

Per.	45.00	in.
WT.	2.74	lb/ft
θsa	1.40	°C/w/3"

**XX1112**

Per.	29.37	in.
WT.	1.58	lb/ft
θsa	2.40	°C/w/3"

**B XX5060**

Per.	62.78	in.
WT.	5.21	lb/ft
θsa	0.87	°C/w/3"

**XX8182**

Per.	48.81	in.
WT.	3.49	lb/ft
θsa	1.30	°C/w/3"

**XX5541**

Per.	66.93	in.
WT.	5.14	lb/ft
θsa	1.10	°C/w/3"

**C 016529**

Per.	29.12	in.
WT.	1.81	lb/ft
θsa	3.50	°C/w/3"

**XX3022**

Per.	42.99	in.
WT.	3.04	lb/ft
θsa	1.50	°C/w/3"

**XX3017**

Per.	43.15	in.
WT.	3.21	lb/ft
θsa	1.60	°C/w/3"

**C 016503**

Per.	64.61	in.
WT.	4.07	lb/ft
θsa	1.90	°C/w/3"

**XX7055**

Per.	23.50	in.
WT.	1.15	lb/ft
θsa	2.40	°C/w/3"

**019133**

Per.	54.48	in.
WT.	4.04	lb/ft
θsa	2.40	°C/w/3"

**D 006412**

Per.	41.00	in.
WT.	2.82	lb/ft
θsa	1.70	°C/w/3"

**XX3012**

Per.	53.45	in.
WT.	4.46	lb/ft
θsa	1.50	°C/w/3"

**XX3013**

Per.	49.20	in.
WT.	3.21	lb/ft
θsa	1.60	°C/w/3"

**D 014343**

Per.	29.47	in.
WT.	1.71	lb/ft
θsa	2.40	°C/w/3"

**014344**

Per.	17.43	in.
WT.	0.90	lb/ft
θsa	4.00	°C/w/3"

**XX4874**

Per.	30.64	in.
WT.	2.60	lb/ft
θsa	2.10	°C/w/3"

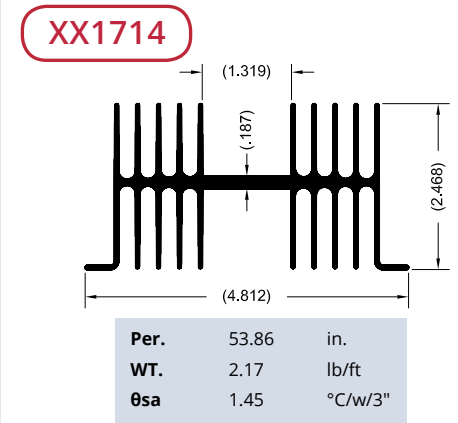
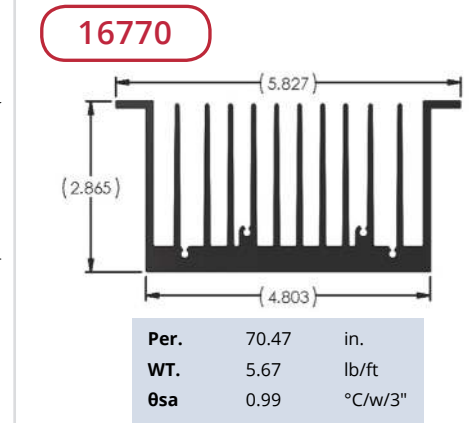
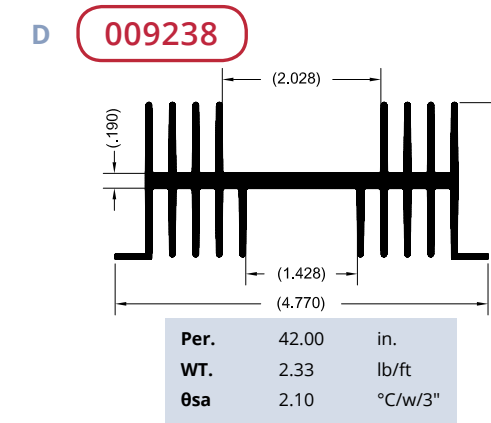
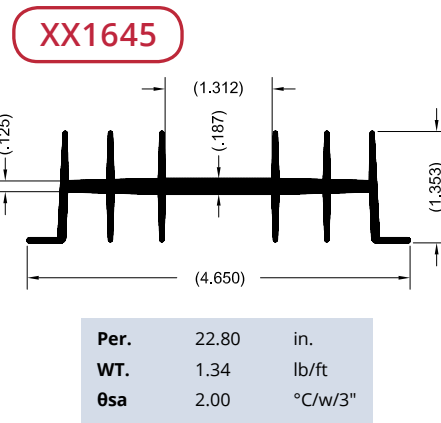
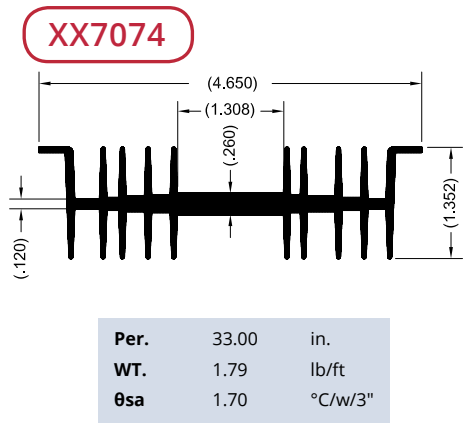
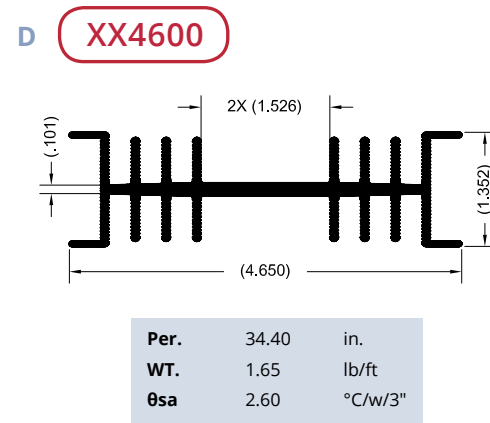
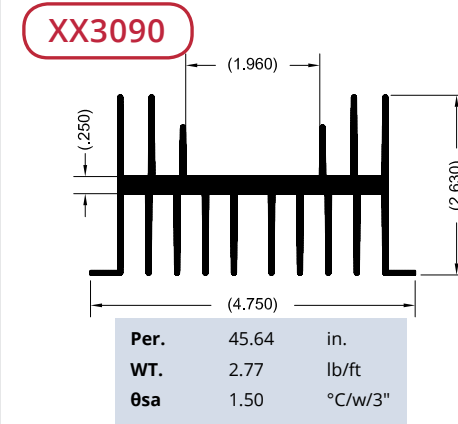
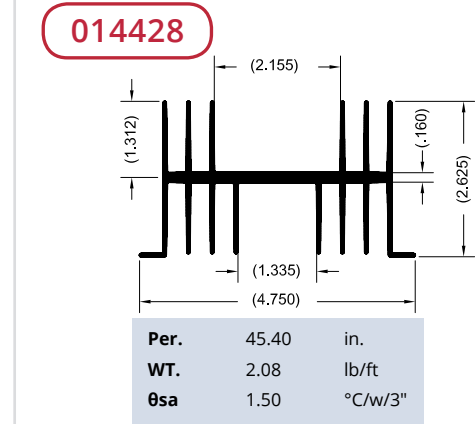
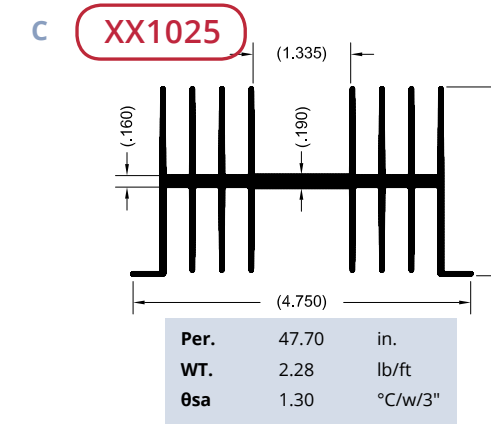
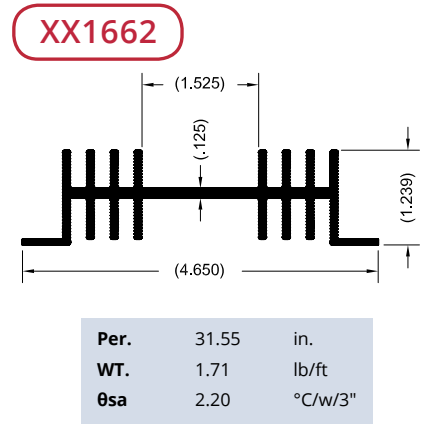
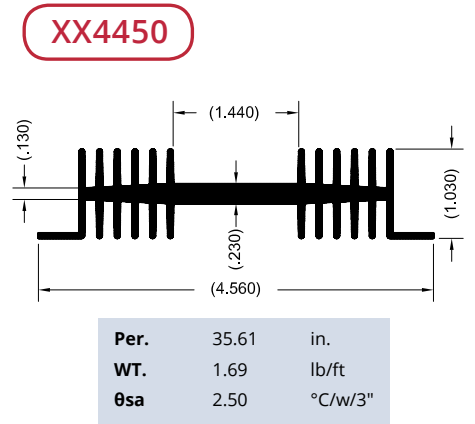
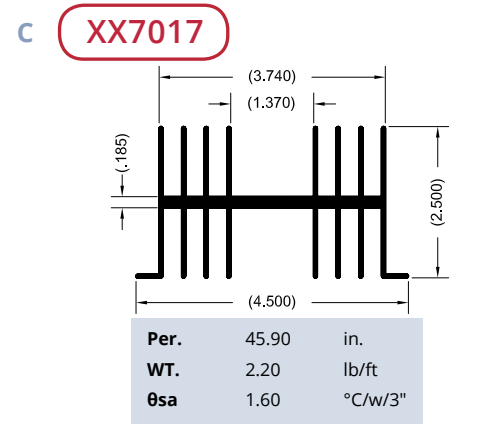
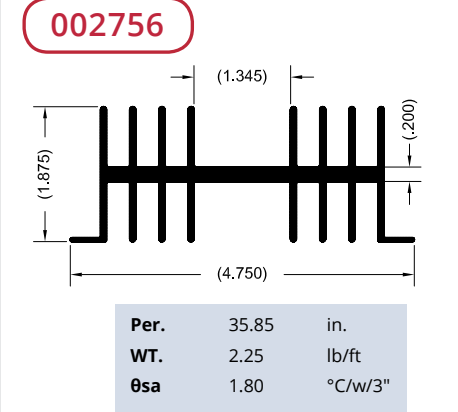
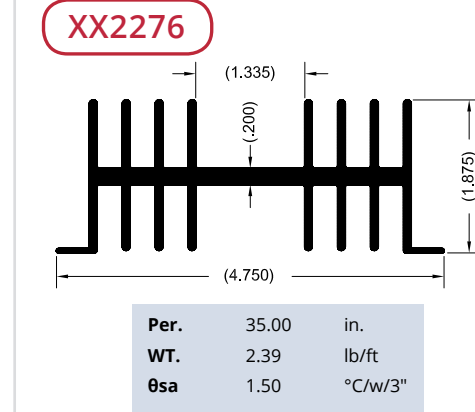
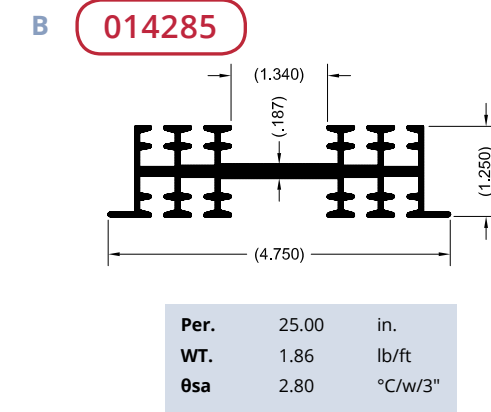
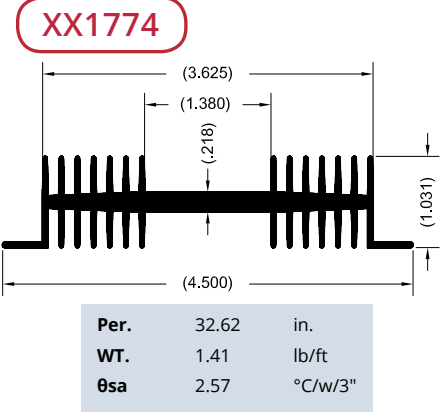
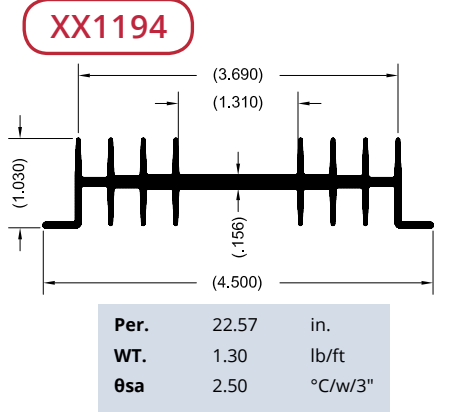
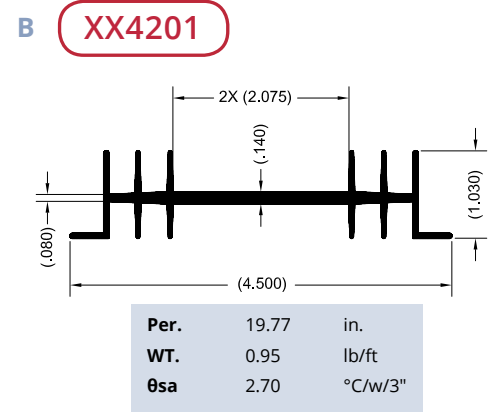
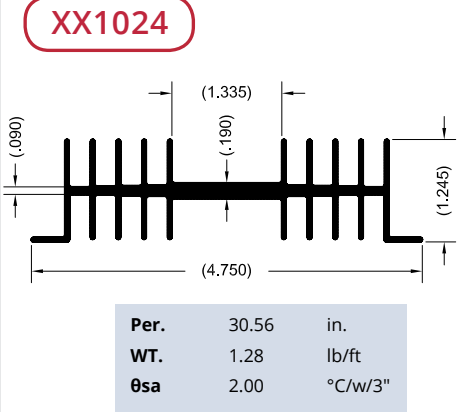
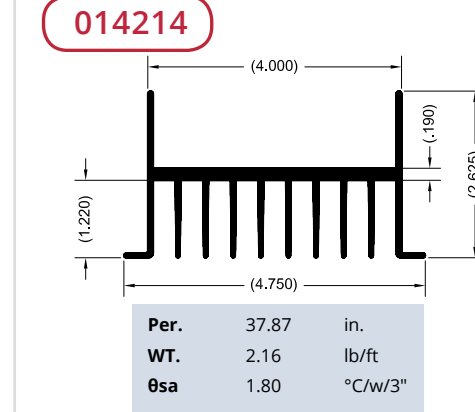
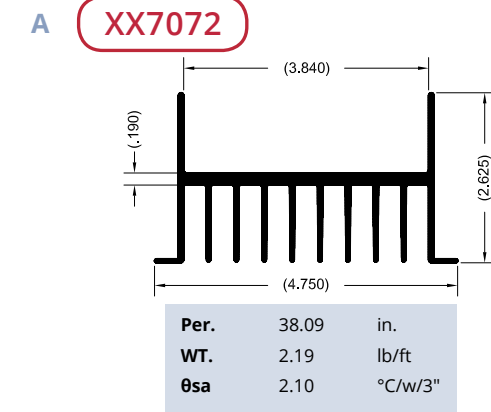
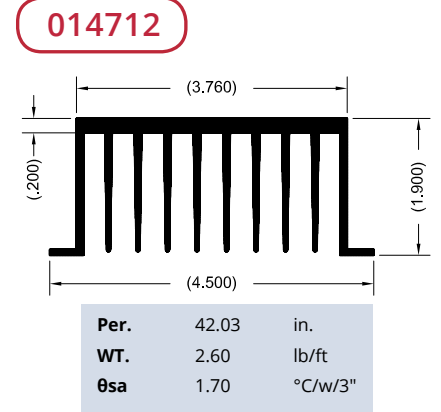
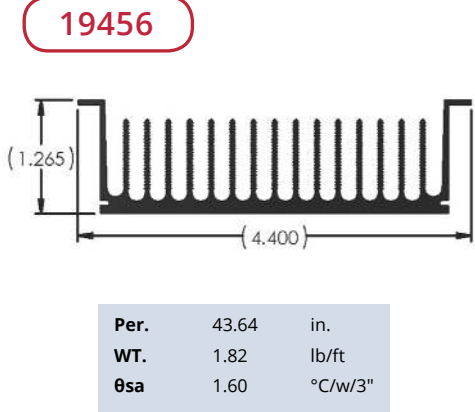
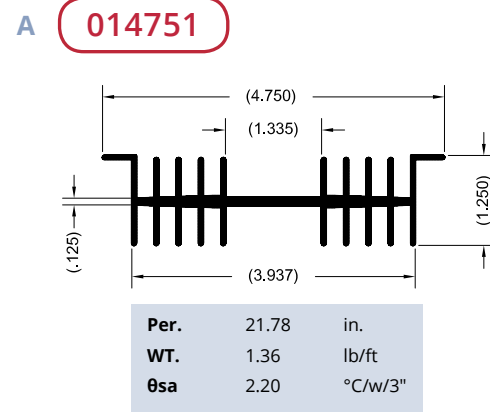

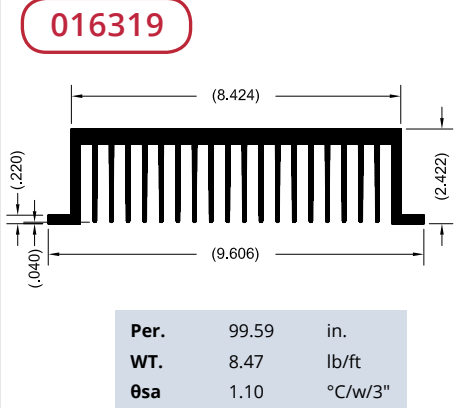
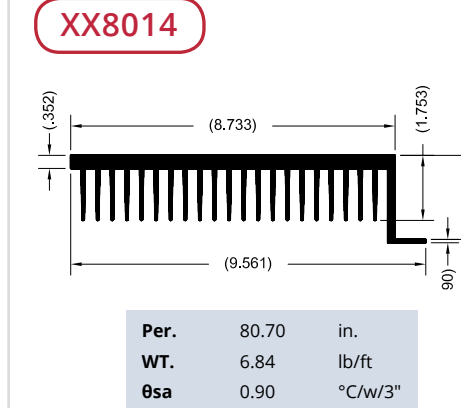
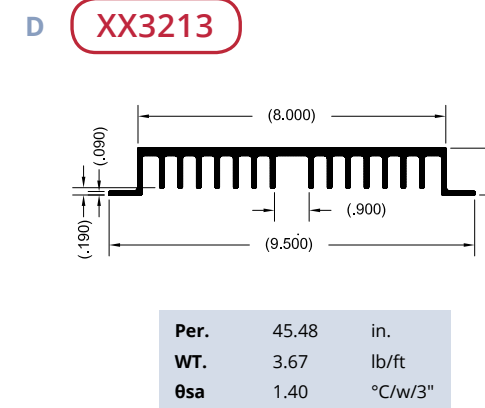
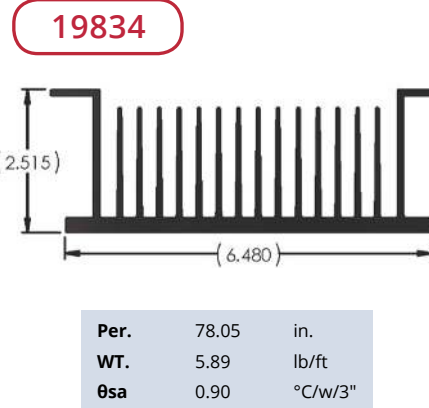
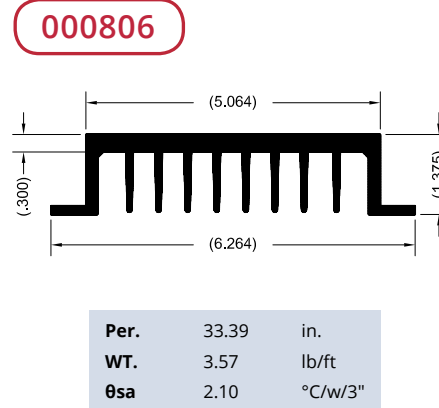
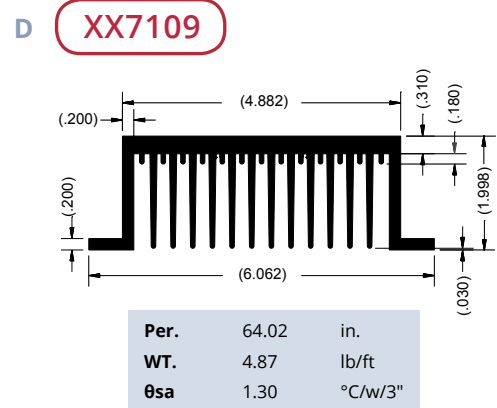
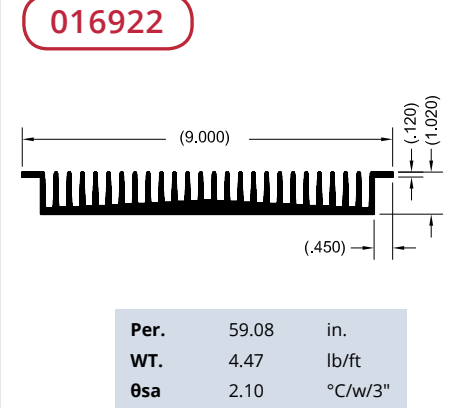
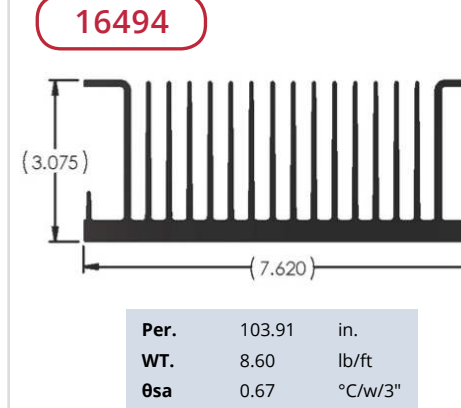
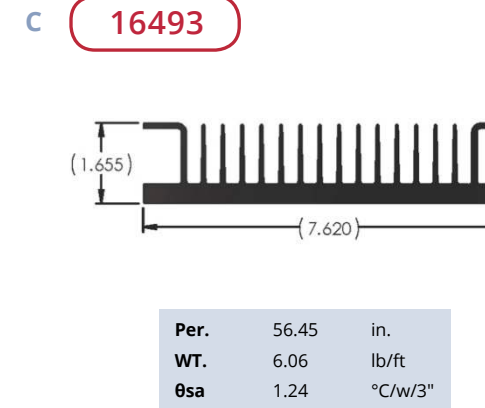
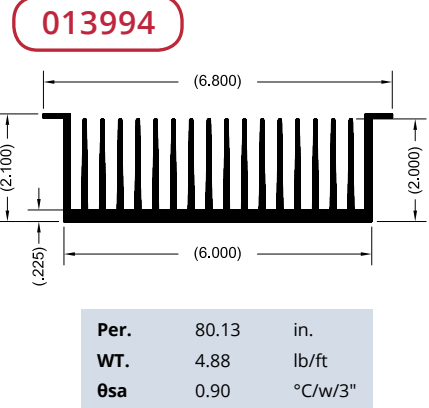
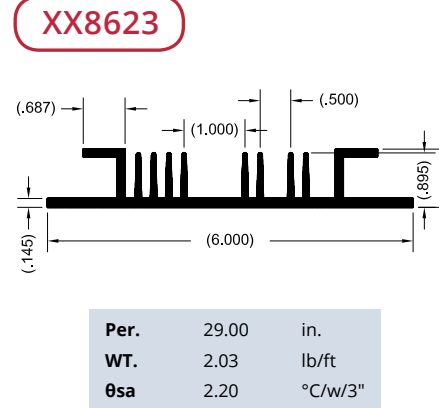
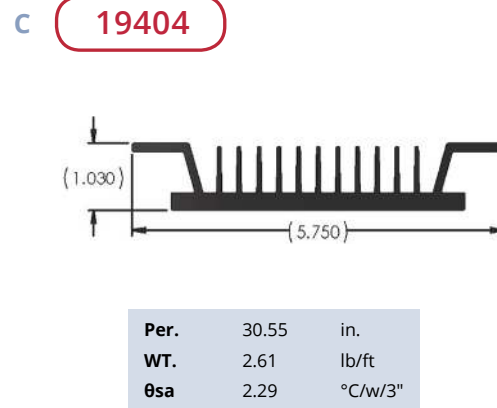
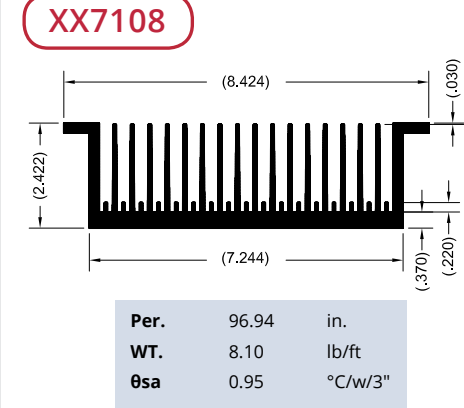
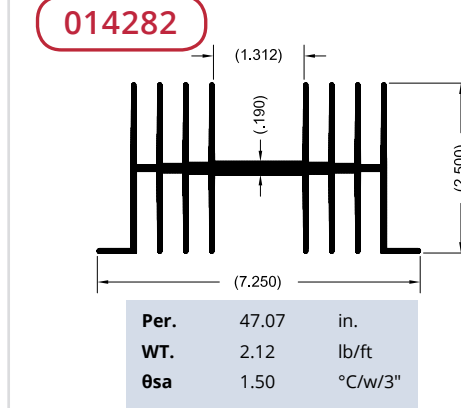
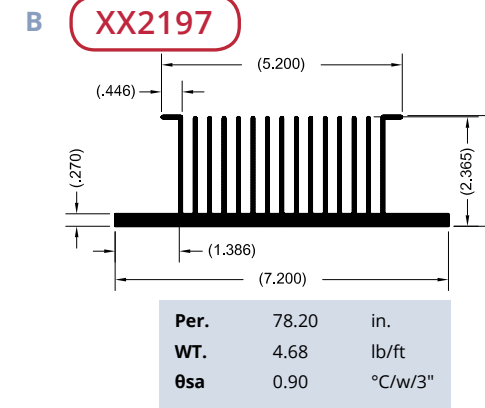
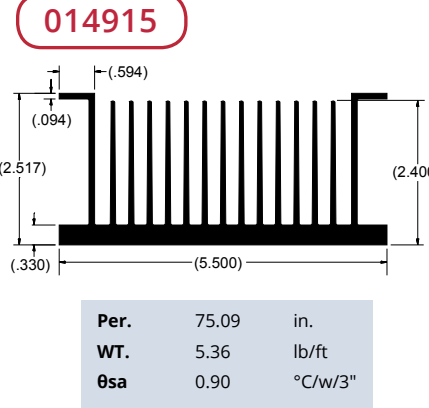
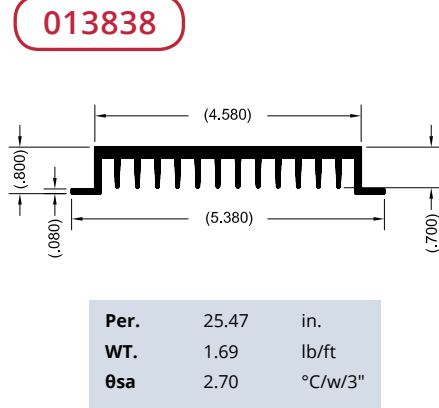
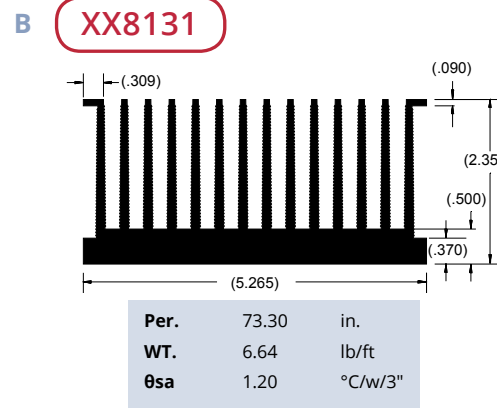
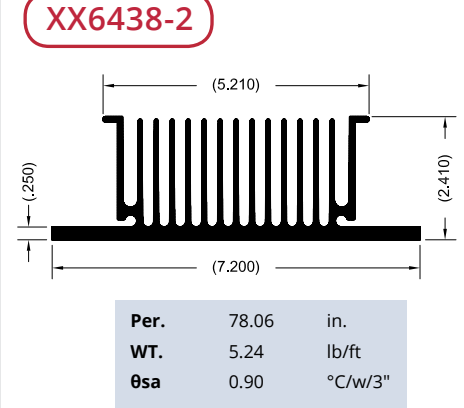
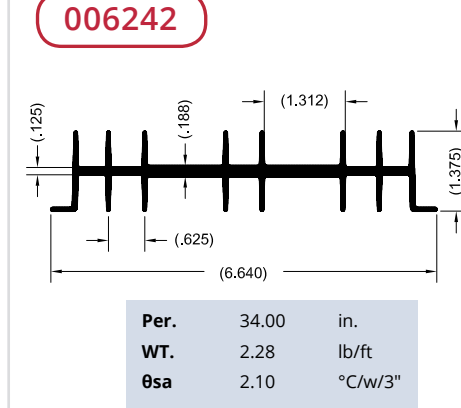
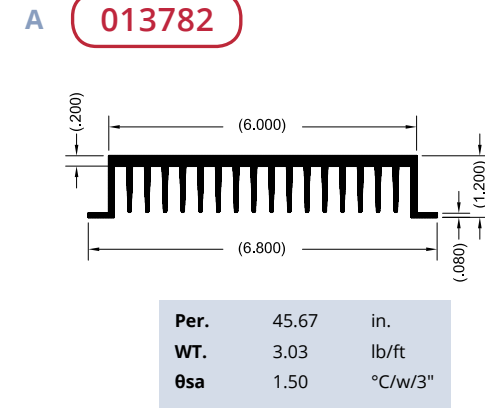
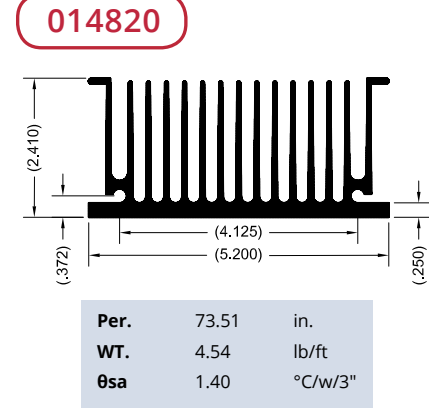
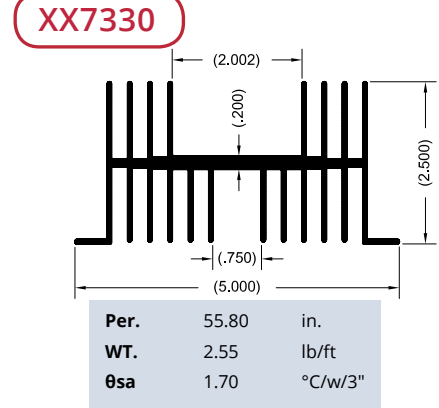
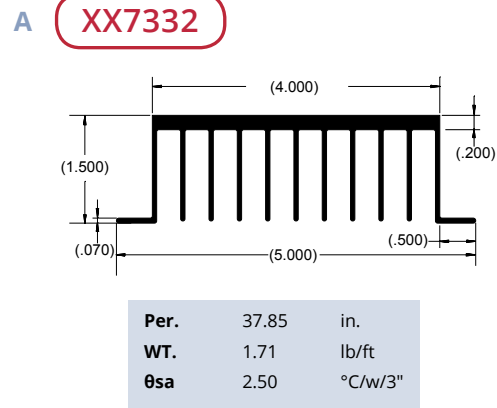



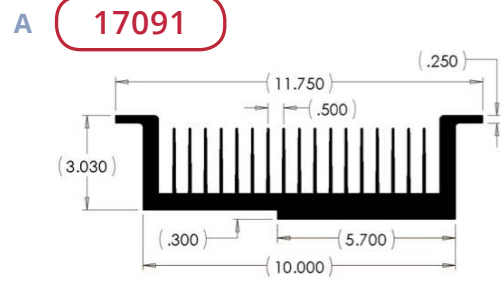

Per.	105.27	in.
WT.	15.43	lb/ft
θsa	0.66	°C/w/3"

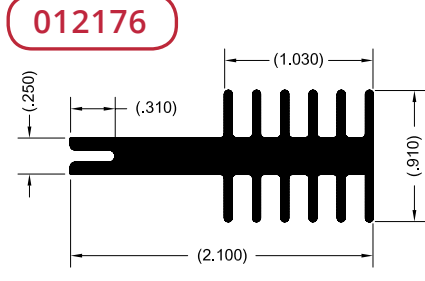

Per.	12.65	in.
WT.	0.81	lb/ft
θsa	5.50	°C/w/3"

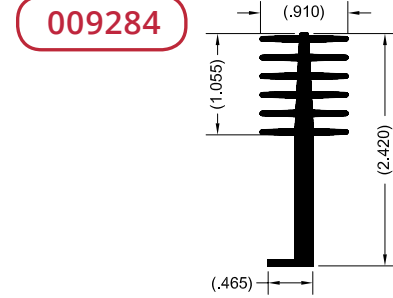

Per.	15.24	in.
WT.	0.80	lb/ft
θsa	4.60	°C/w/3"

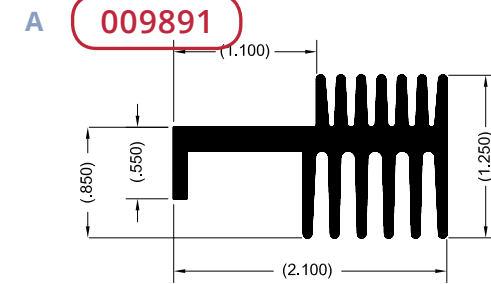

Per.	14.74	in.
WT.	1.11	lb/ft
θsa	4.70	°C/w/3"

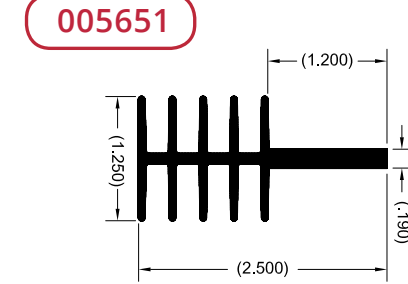

Per.	18.00	in.
WT.	0.88	lb/ft
θsa	3.90	°C/w/3"

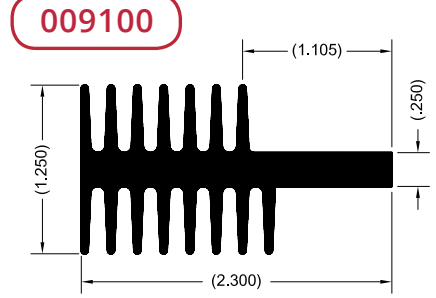

Per.	20.10	in.
WT.	1.23	lb/ft
θsa	3.50	°C/w/3"

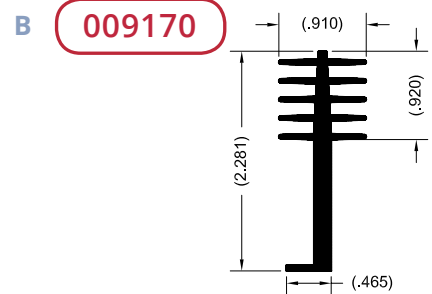

Per.	13.50	in.
WT.	0.73	lb/ft
θsa	5.20	°C/w/3"

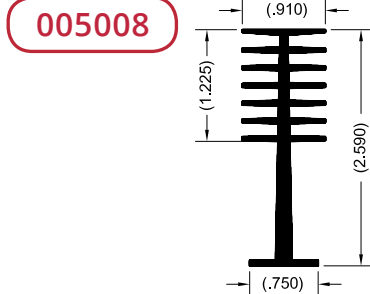

Per.	20.00	in.
WT.	0.81	lb/ft
θsa	3.50	°C/w/3"

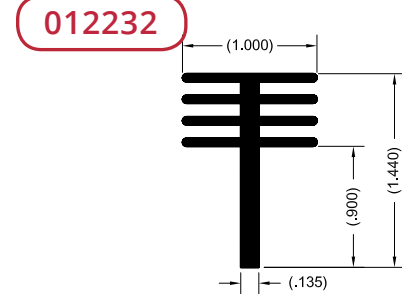

Per.	9.80	in.
WT.	0.47	lb/ft
θsa	7.10	°C/w/3"

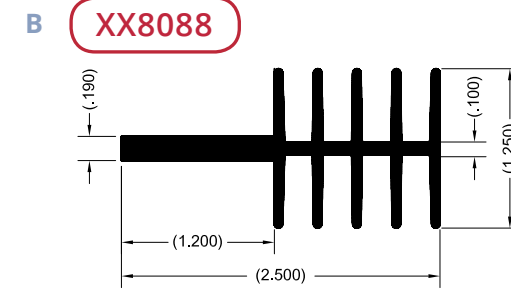

Per.	14.65	in.
WT.	0.93	lb/ft
θsa	4.20	°C/w/3"

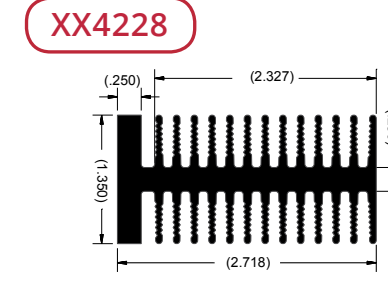

Per.	38.93	in.
WT.	2.29	lb/ft
θsa	1.90	°C/w/3"

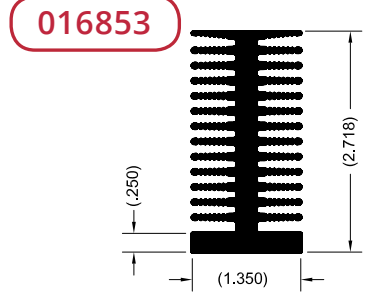

Per.	39.17	in.
WT.	2.28	lb/ft
θsa	3.10	°C/w/3"

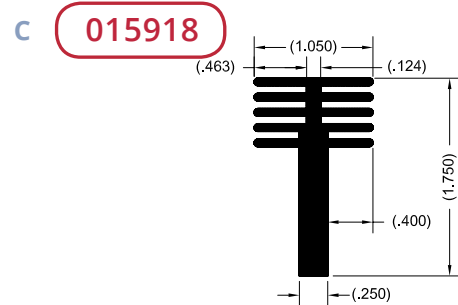

Per.	13.22	in.
WT.	0.78	lb/ft
θsa	0.00	°C/w/3"

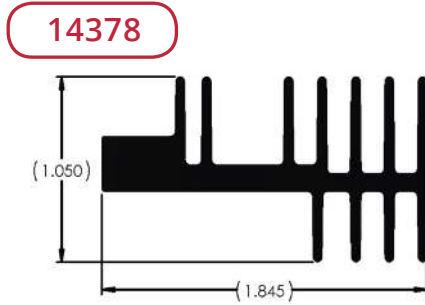

Per.	13.90	in.
WT.	0.72	lb/ft
θsa	5.03	°C/w/3"

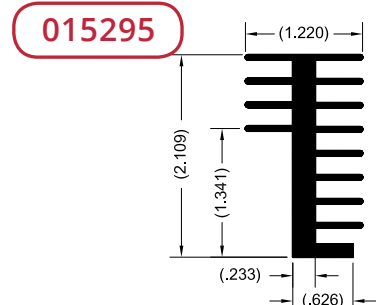

Per.	17.15	in.
WT.	1.04	lb/ft
θsa	0.00	°C/w/3"

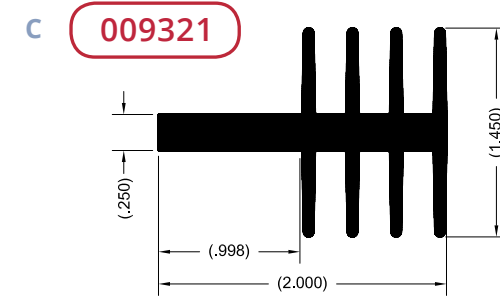

Per.	14.83	in.
WT.	1.02	lb/ft
θsa	4.70	°C/w/3"

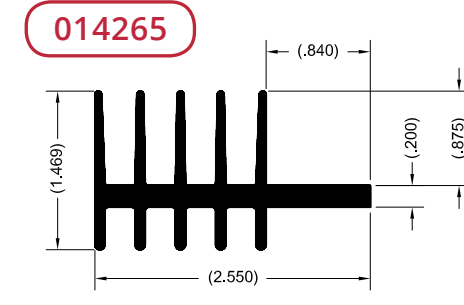

Per.	17.37	in.
WT.	1.33	lb/ft
θsa	4.00	°C/w/3"

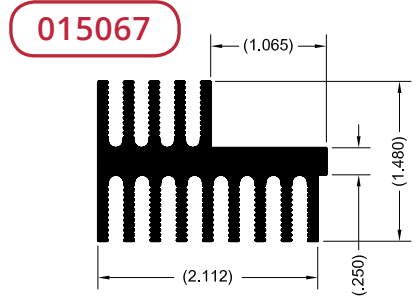

Per.	24.06	in.
WT.	1.50	lb/ft
θsa	2.90	°C/w/3"

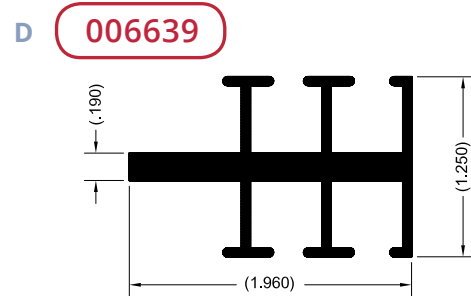

Per.	16.00	in.
WT.	0.73	lb/ft
θsa	4.40	°C/w/3"

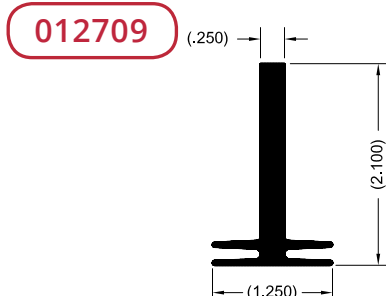

Per.	8.40	in.
WT.	0.76	lb/ft
θsa	8.30	°C/w/3"

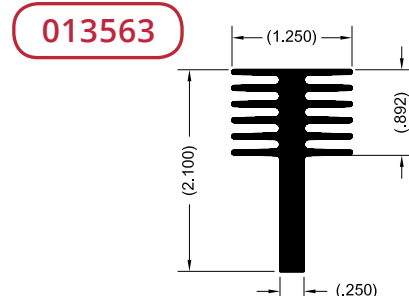

Per.	15.81	in.
WT.	1.02	lb/ft
θsa	4.40	°C/w/3"

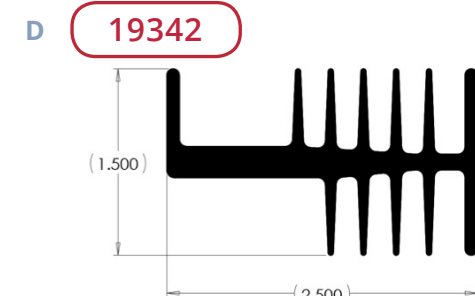

Per.	19.99	in.
WT.	1.32	lb/ft
θsa	3.50	°C/w/3"

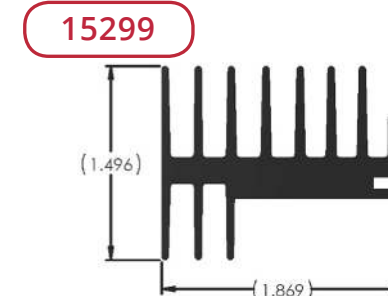

Per.	18.01	in.
WT.	1.14	lb/ft
θsa	3.88	°C/w/3"

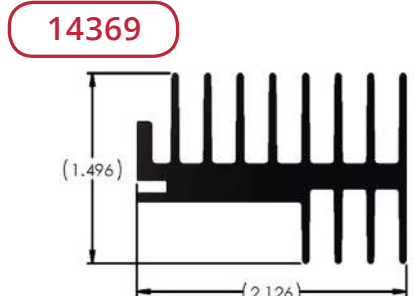

Per.	21.10	in.
WT.	1.23	lb/ft
θsa	3.31	°C/w/3"

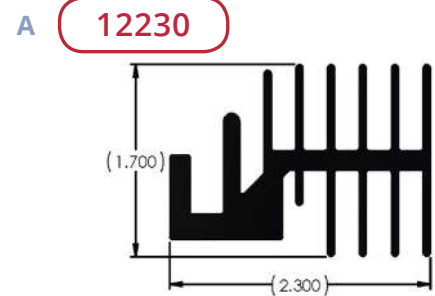

Per.	23.61	in.
WT.	1.66	lb/ft
θsa	2.96	°C/w/3"

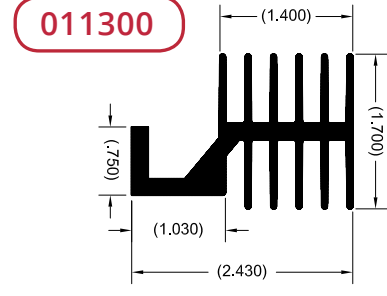

Per.	24.26	in.
WT.	1.71	lb/ft
θsa	2.90	°C/w/3"

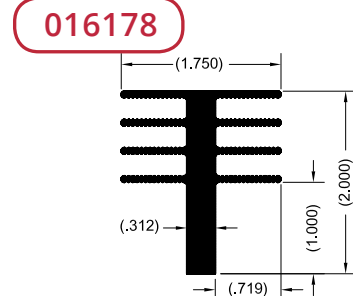

Per.	17.80	in.
WT.	1.33	lb/ft
θsa	4.00	°C/w/3"

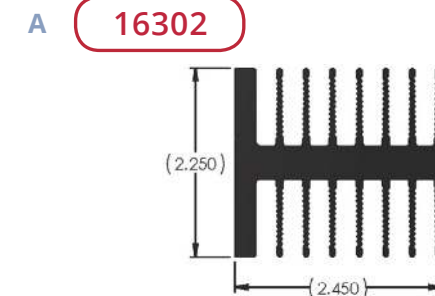

Per.	37.98	in.
WT.	2.74	lb/ft
θsa	1.84	°C/w/3"

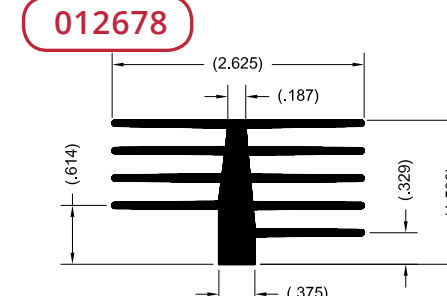

Per.	24.10	in.
WT.	1.39	lb/ft
θsa	2.90	°C/w/3"

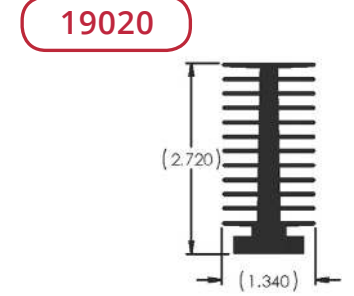

Per.	31.44	in.
WT.	1.98	lb/ft
θsa	2.22	°C/w/3"

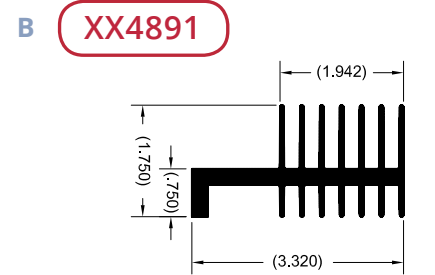

Per.	28.31	in.
WT.	1.96	lb/ft
θsa	2.00	°C/w/3"

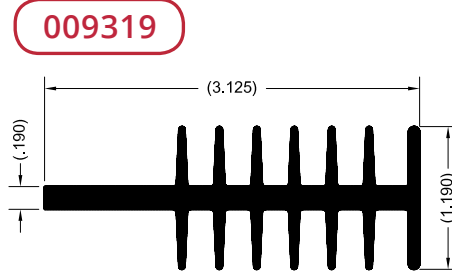

Per.	21.63	in.
WT.	1.33	lb/ft
θsa	3.20	°C/w/3"

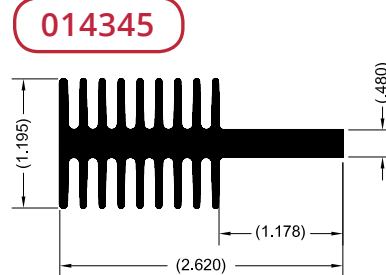

Per.	21.30	in.
WT.	1.33	lb/ft
θsa	3.30	°C/w/3"

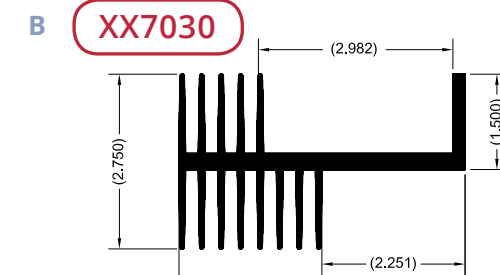

Per.	44.00	in.
WT.	3.58	lb/ft
θsa	1.70	°C/w/3"

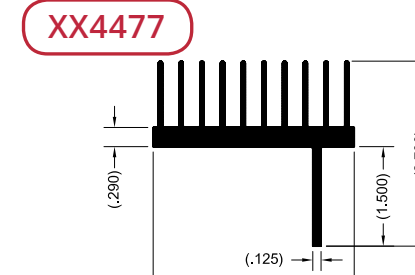

Per.	29.64	in.
WT.	2.00	lb/ft
θsa	3.00	°C/w/3"

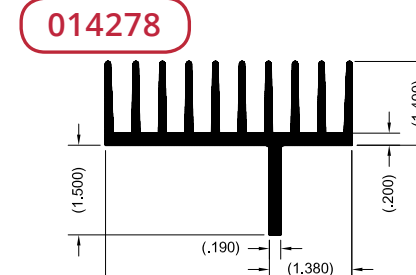

Per.	32.37	in.
WT.	2.80	lb/ft
θsa	2.20	°C/w/3"

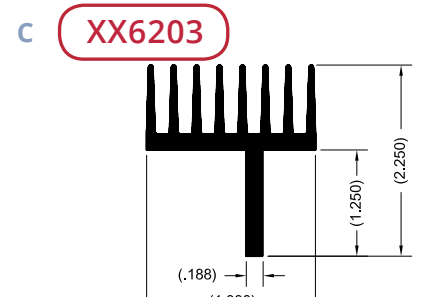

Per.	19.11	in.
WT.	1.31	lb/ft
θsa	2.50	°C/w/3"

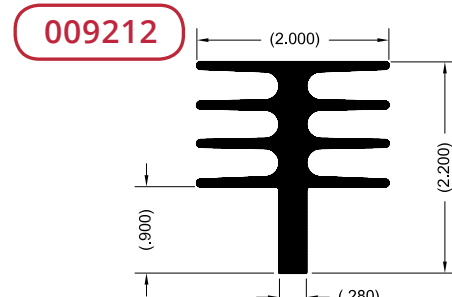

Per.	18.17	in.
WT.	1.48	lb/ft
θsa	3.90	°C/w/3"

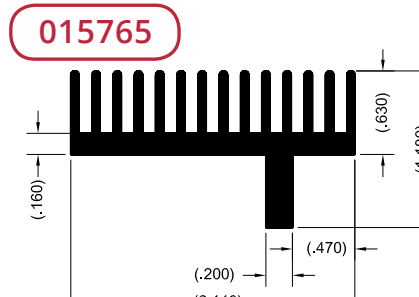

Per.	18.94	in.
WT.	1.01	lb/ft
θsa	0.00	°C/w/3"

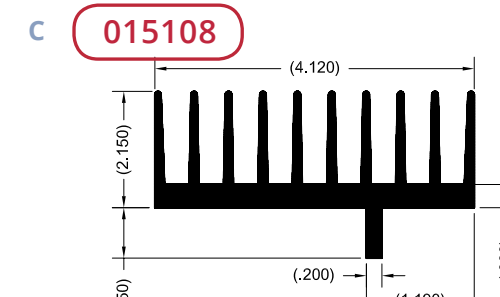

Per.	33.37	in.
WT.	3.10	lb/ft
θsa	2.10	°C/w/3"

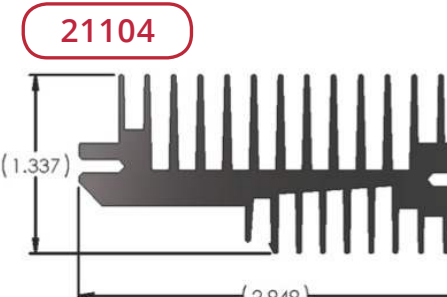

Per.	33.30	in.
WT.	1.75	lb/ft
θsa	2.10	°C/w/3"

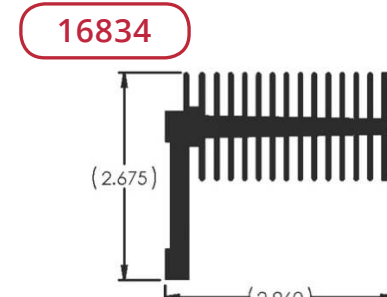

Per.	43.16	in.
WT.	2.69	lb/ft
θsa	1.62	°C/w/3"

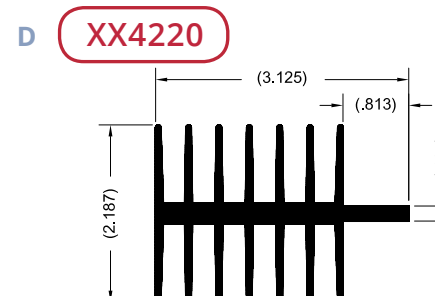

Per.	33.07	in.
WT.	2.17	lb/ft
θsa	2.40	°C/w/3"

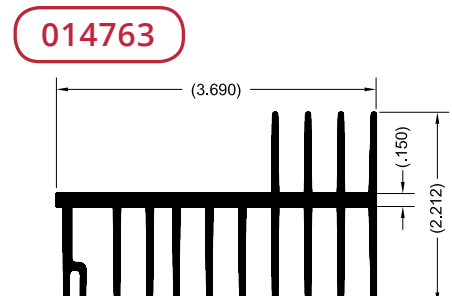

Per.	53.62	in.
WT.	1.71	lb/ft
θsa	1.30	°C/w/3"

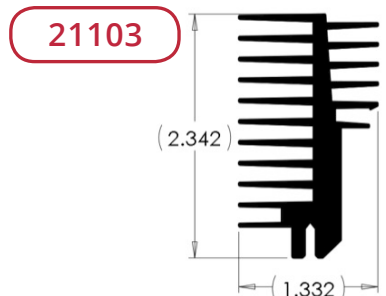

Per.	25.34	in.
WT.	1.30	lb/ft
θsa	2.76	°C/w/3"

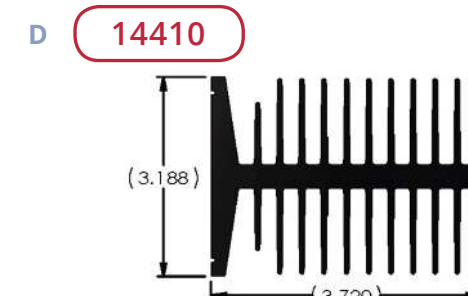

Per.	70.72	in.
WT.	5.27	lb/ft
θsa	0.99	°C/w/3"

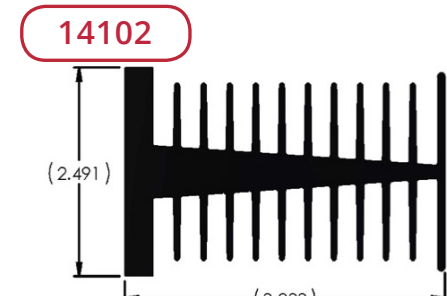

Per.	49.55	in.
WT.	4.43	lb/ft
θsa	1.41	°C/w/3"

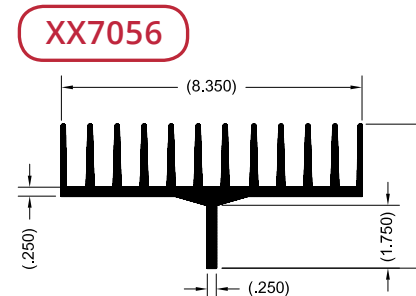

Per.	61.07	in.
WT.	6.95	lb/ft
θsa	1.30	°C/w/3"

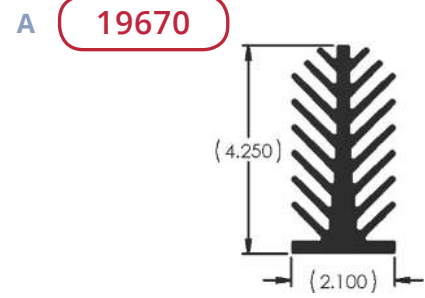

Per.	41.76	in.
WT.	5.11	lb/ft
θsa	1.67	°C/w/3"

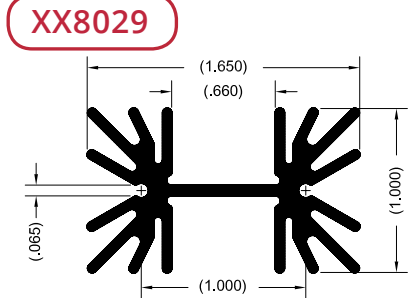

Per.	14.60	in.
WT.	0.48	lb/ft
θsa	3.40	°C/w/3"

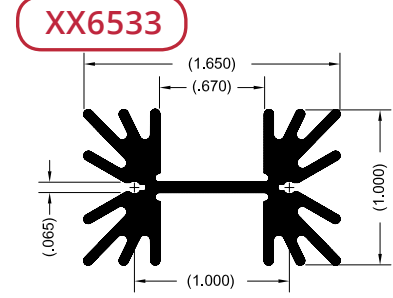

Per.	10.80	in.
WT.	0.65	lb/ft
θsa	3.60	°C/w/3"

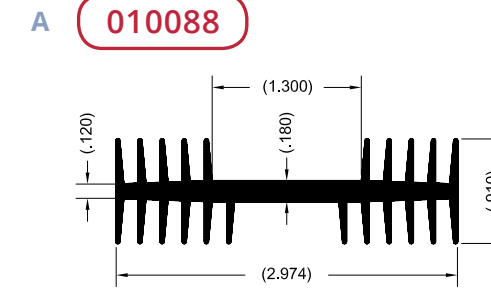

Per.	23.50	in.
WT.	1.12	lb/ft
θsa	3.00	°C/w/3"

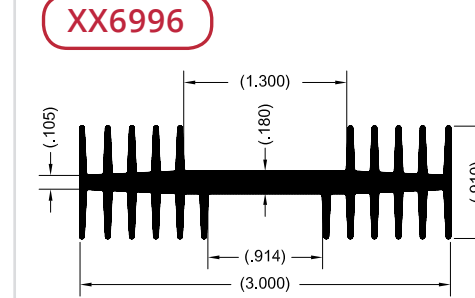

Per.	22.52	in.
WT.	1.02	lb/ft
θsa	3.20	°C/w/3"

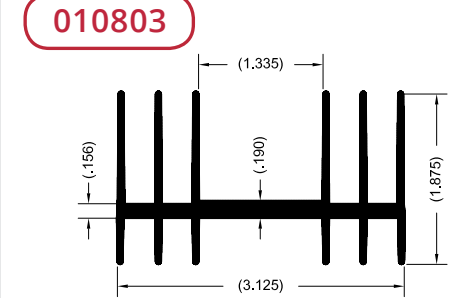

Per.	27.00	in.
WT.	1.47	lb/ft
θsa	2.60	°C/w/3"

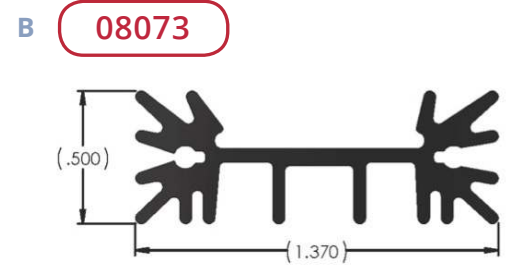

Per.	7.78	in.
WT.	0.28	lb/ft
θsa	8.98	°C/w/3"

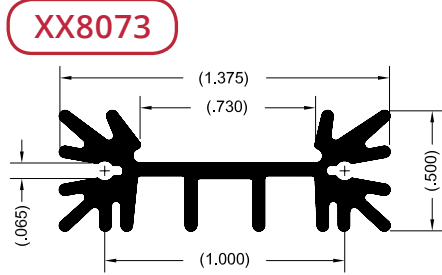

Per.	7.79	in.
WT.	0.27	lb/ft
θsa	6.80	°C/w/3"

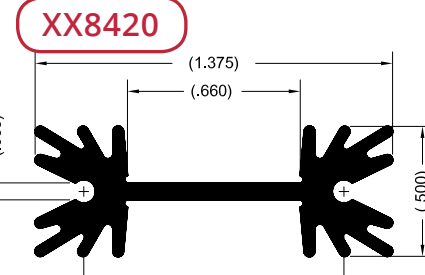

Per.	7.07	in.
WT.	0.29	lb/ft
θsa	6.80	°C/w/3"

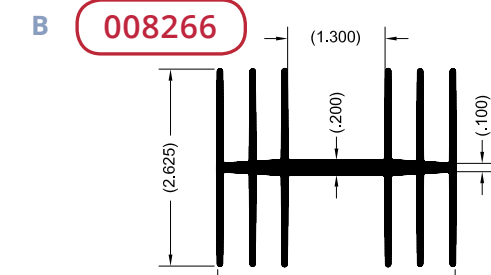

Per.	35.50	in.
WT.	1.80	lb/ft
θsa	2.00	°C/w/3"

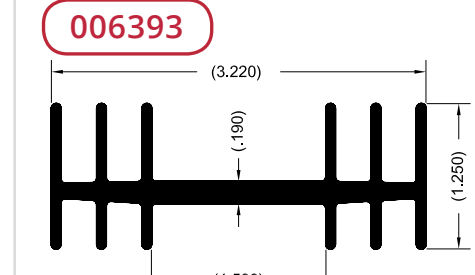

Per.	19.00	in.
WT.	1.36	lb/ft
θsa	3.70	°C/w/3"

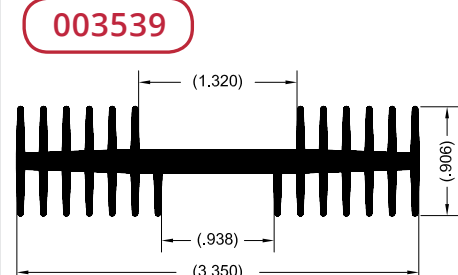

Per.	26.50	in.
WT.	1.18	lb/ft
θsa	2.60	°C/w/3"

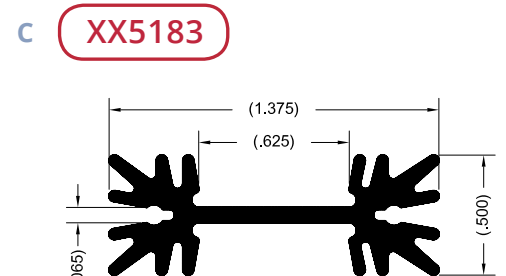

Per.	7.35	in.
WT.	0.34	lb/ft
θsa	7.00	°C/w/3"

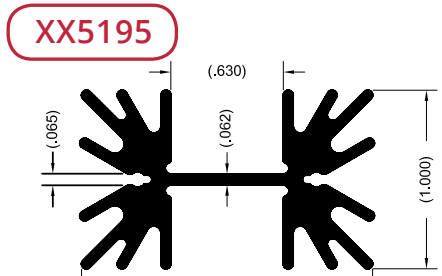

Per.	12.58	in.
WT.	0.68	lb/ft
θsa	3.60	°C/w/3"

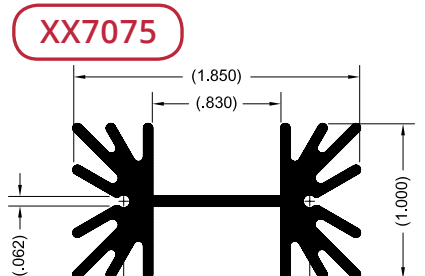

Per.	12.55	in.
WT.	0.70	lb/ft
θsa	6.00	°C/w/3"

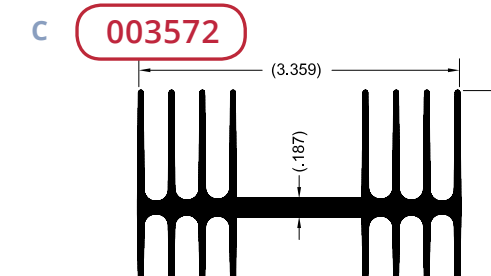

Per.	36.20	in.
WT.	1.62	lb/ft
θsa	1.90	°C/w/3"

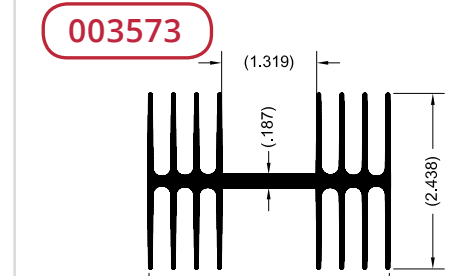

Per.	43.20	in.
WT.	1.91	lb/ft
θsa	1.60	°C/w/3"

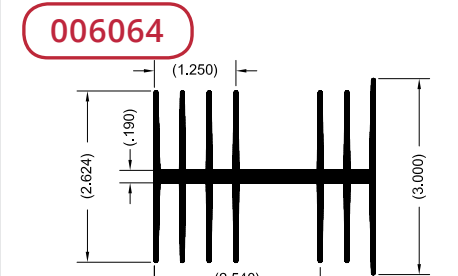

Per.	42.00	in.
WT.	2.45	lb/ft
θsa	1.70	°C/w/3"

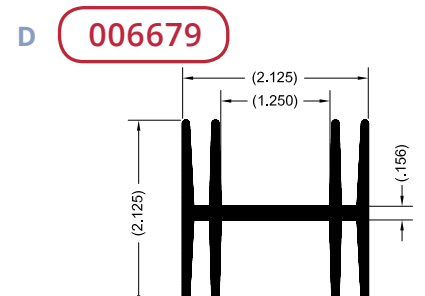

Per.	20.31	in.
WT.	1.34	lb/ft
θsa	3.40	°C/w/3"

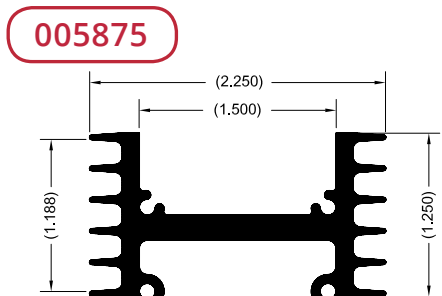

Per.	16.50	in.
WT.	1.04	lb/ft
θsa	4.20	°C/w/3"

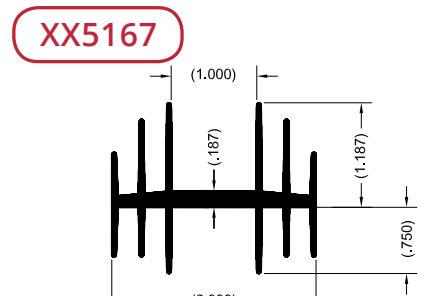

Per.	21.80	in.
WT.	1.09	lb/ft
θsa	3.40	°C/w/3"

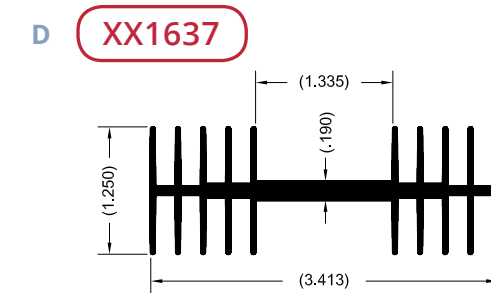

Per.	28.00	in.
WT.	1.20	lb/ft
θsa	2.50	°C/w/3"

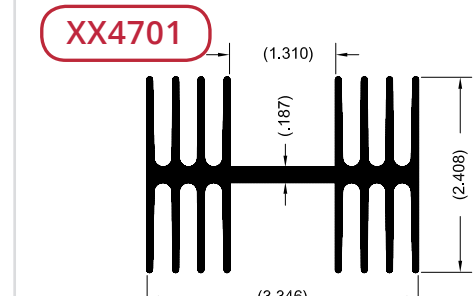

Per.	40.71	in.
WT.	2.35	lb/ft
θsa	1.90	°C/w/3"

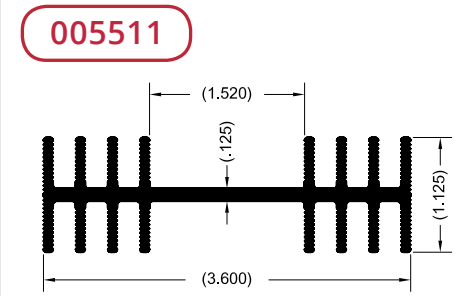

Per.	24.00	in.
WT.	1.31	lb/ft
θsa	2.90	°C/w/3"

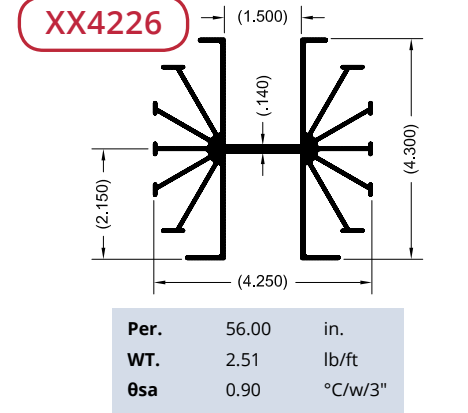
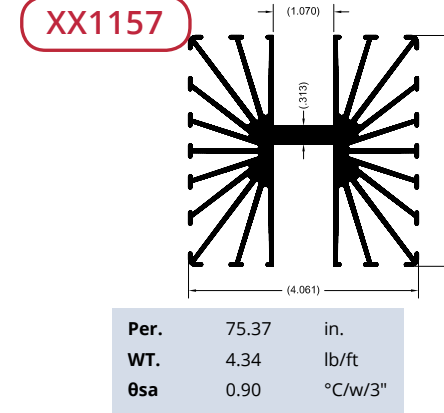
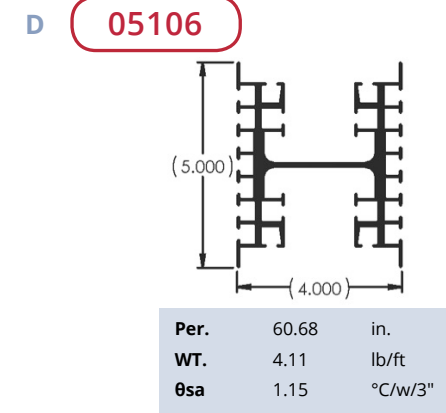
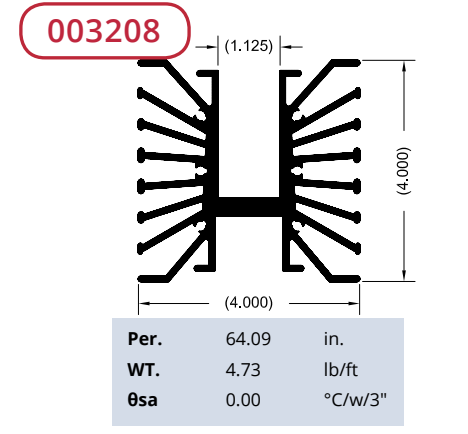
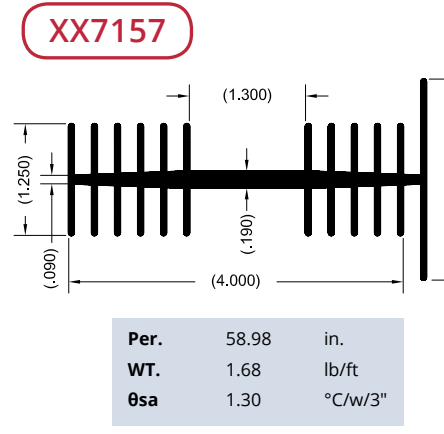
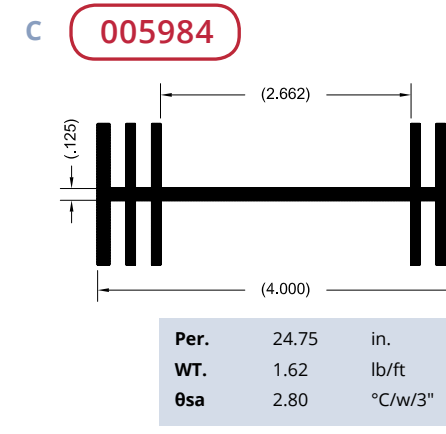
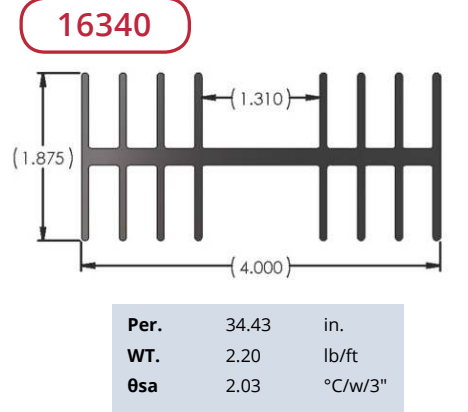
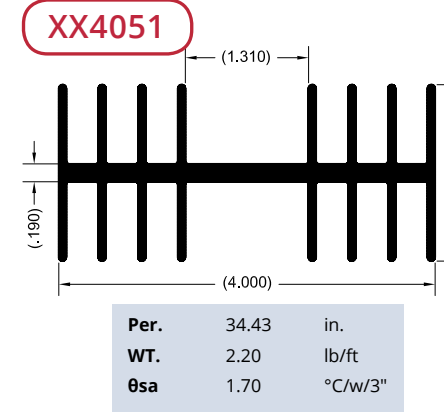
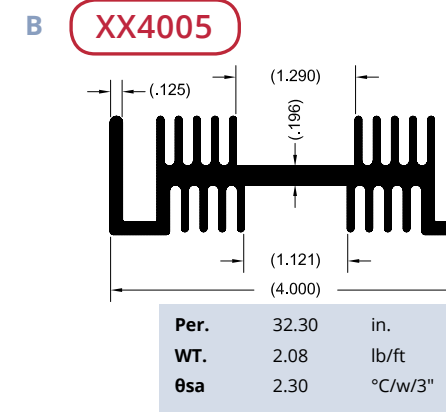
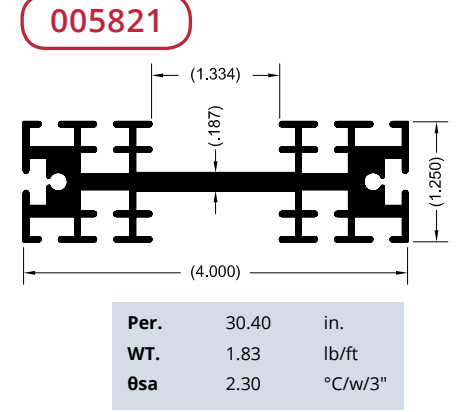
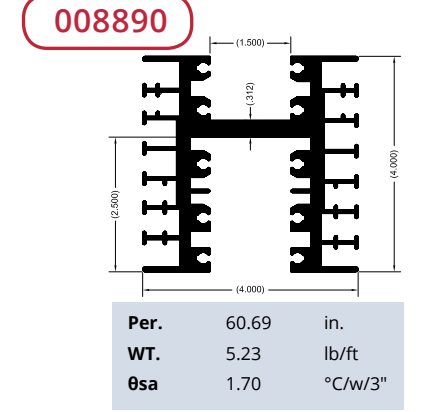
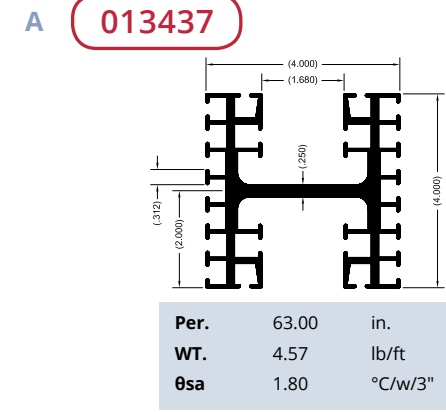
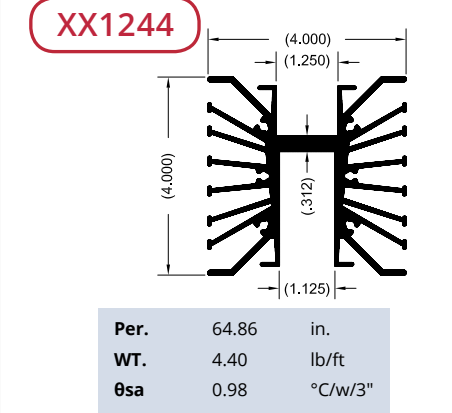
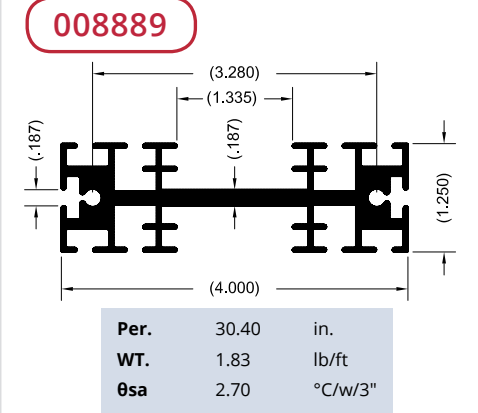
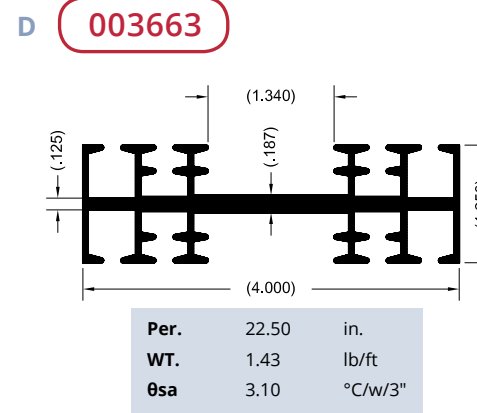
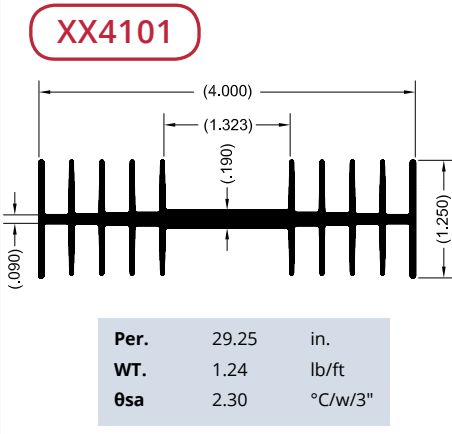
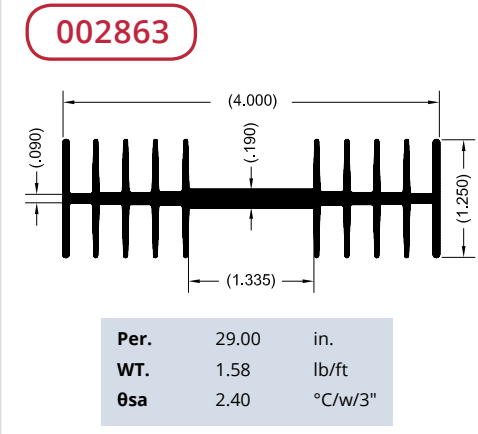
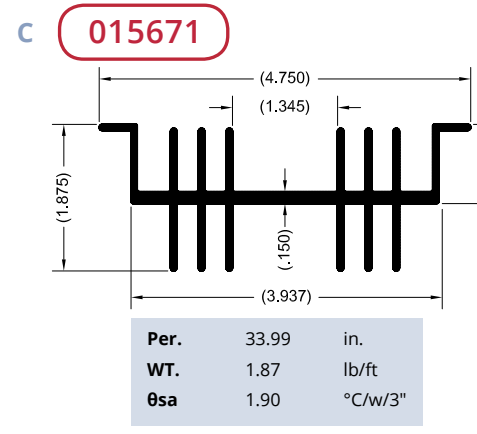
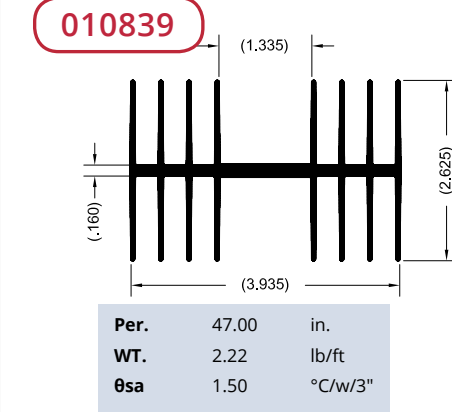
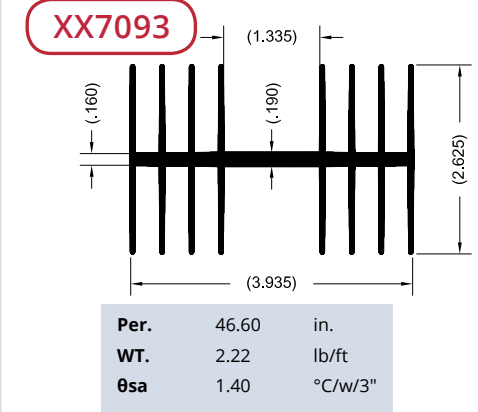
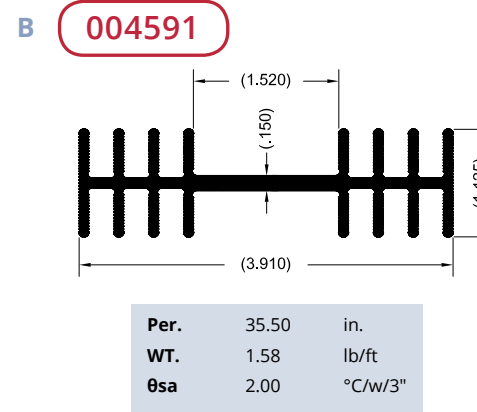
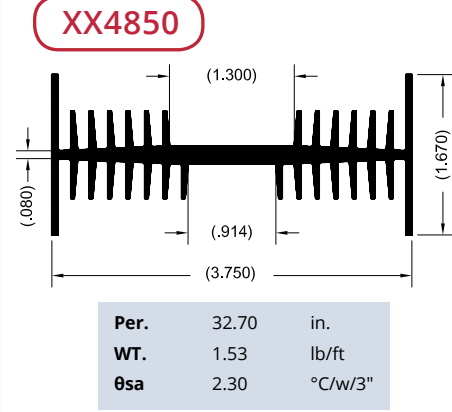
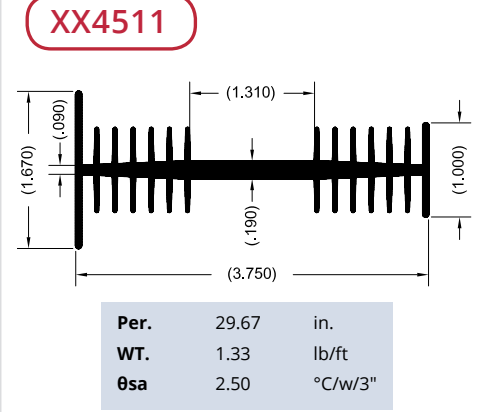
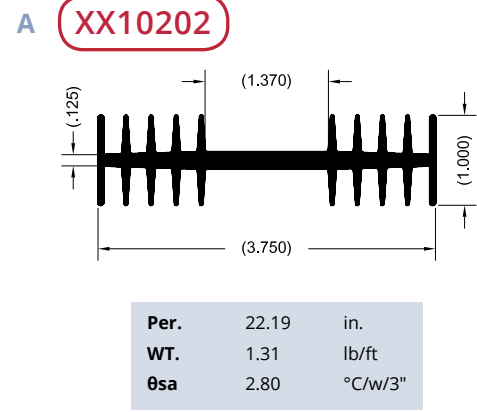



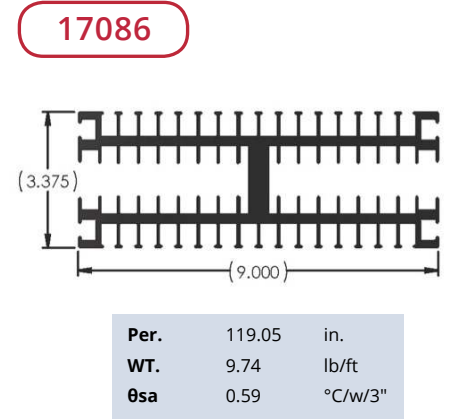
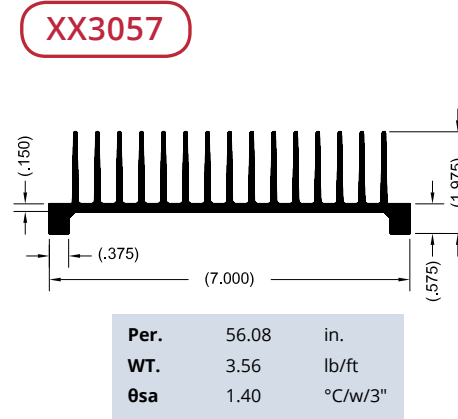
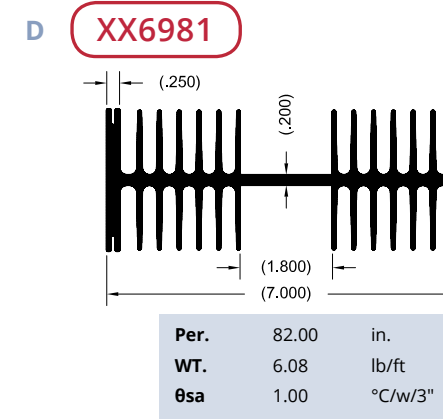
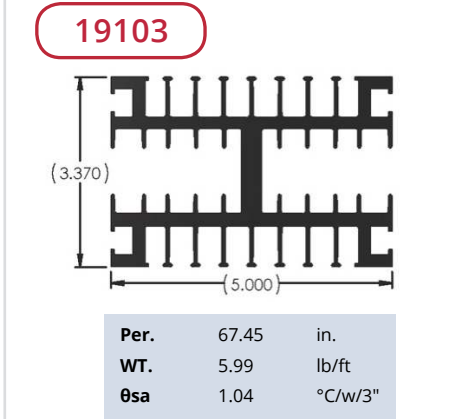
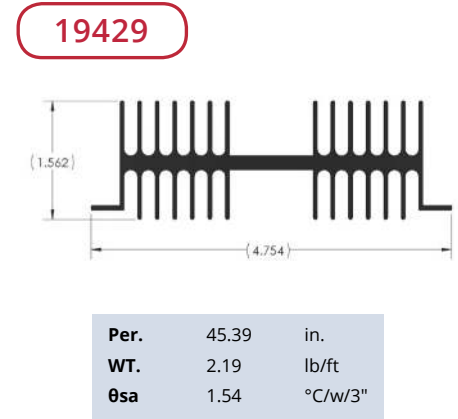
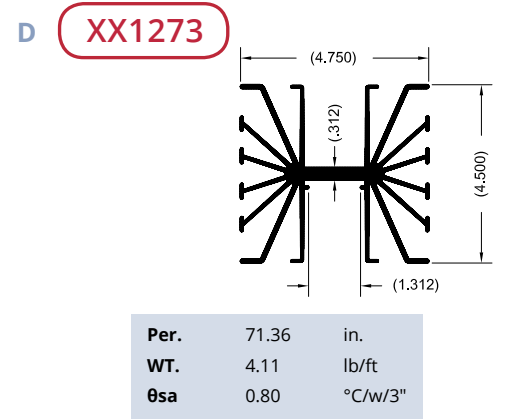
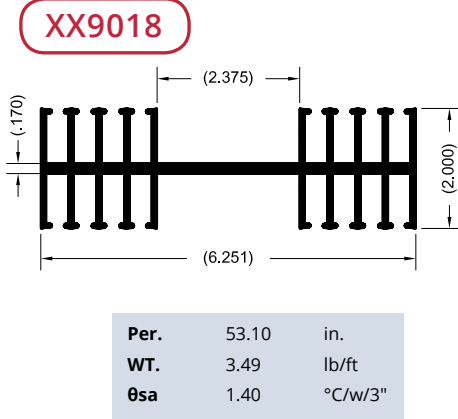
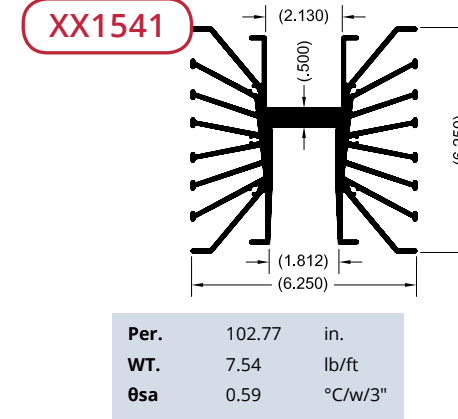
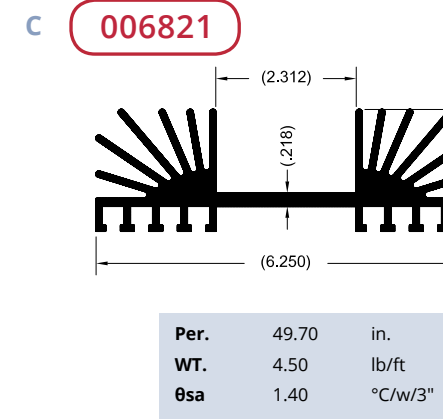
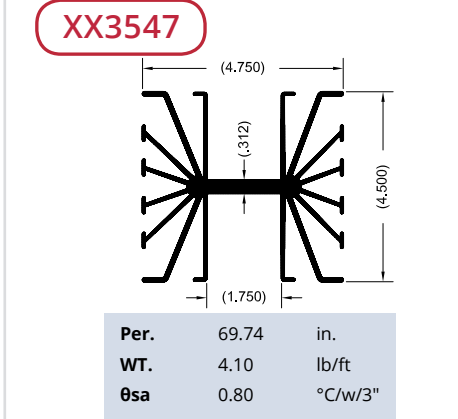
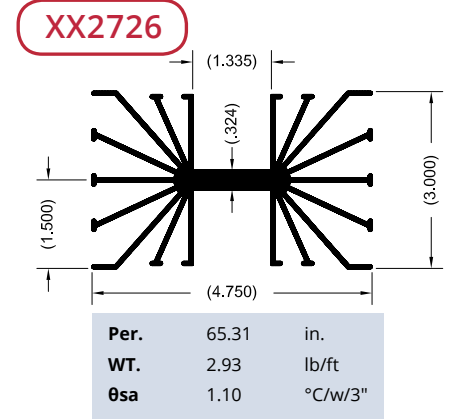
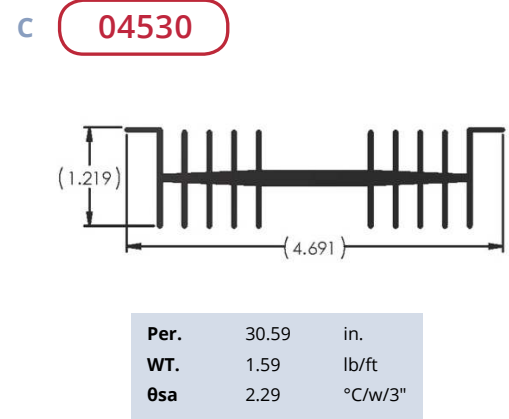
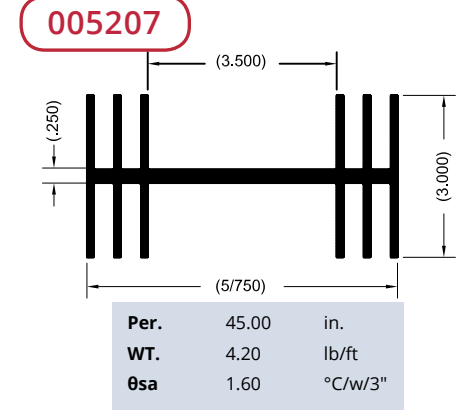
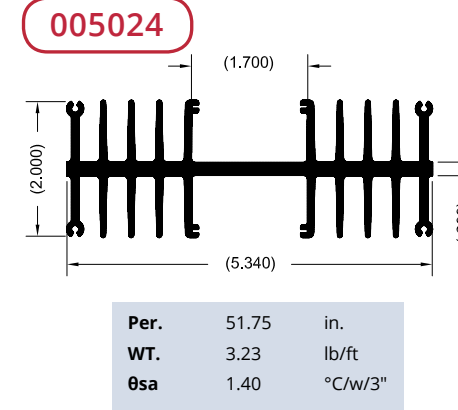
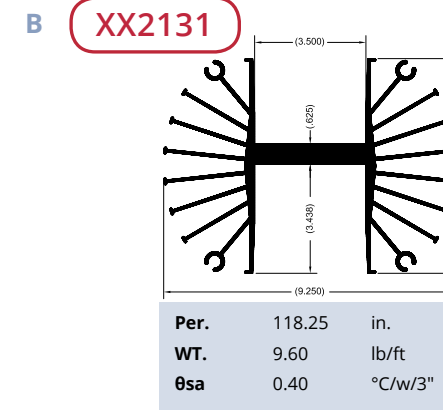
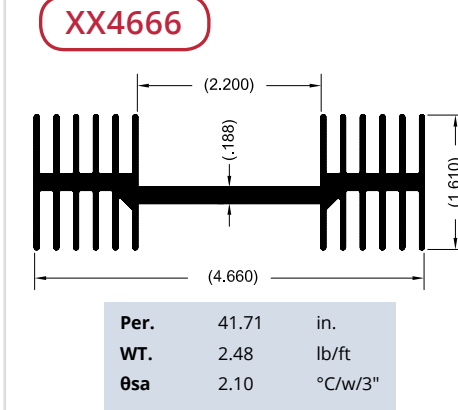
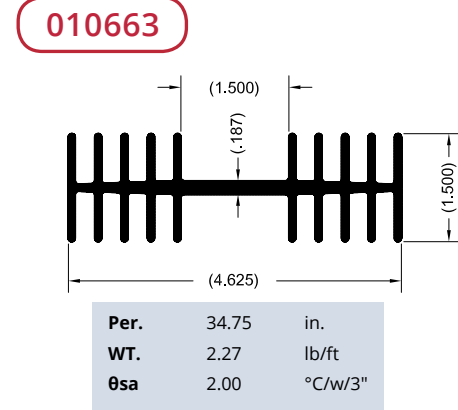
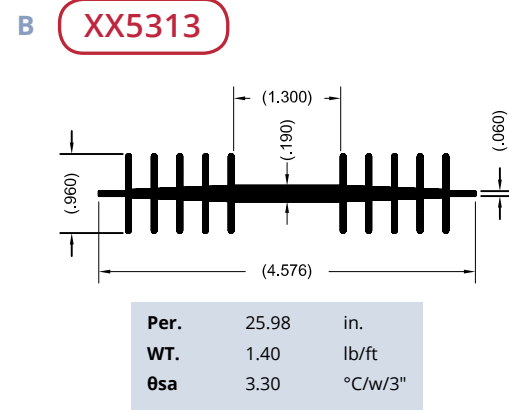
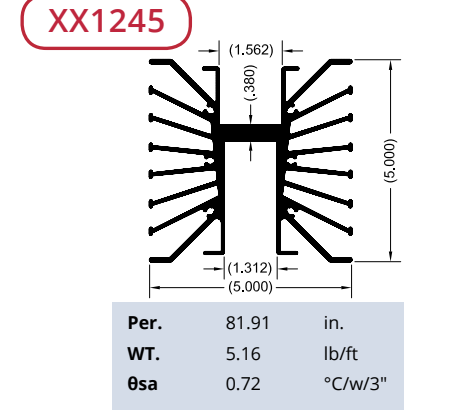
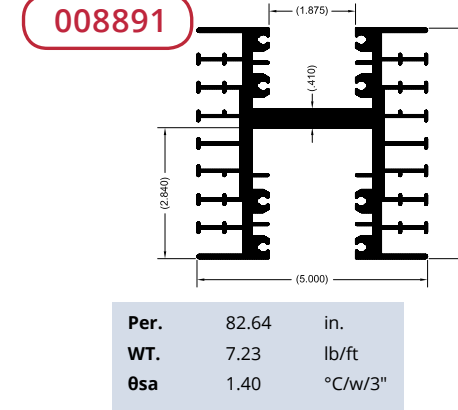
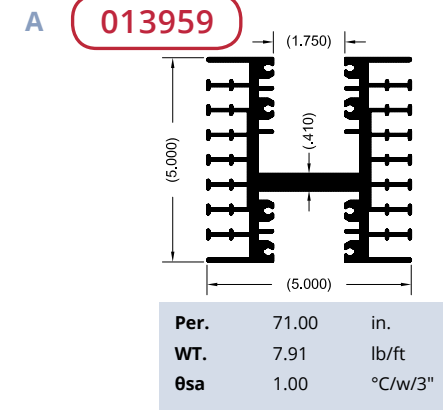
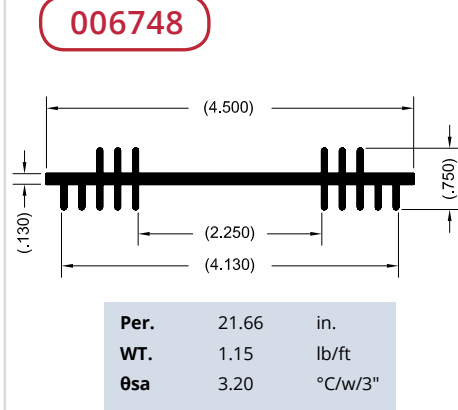
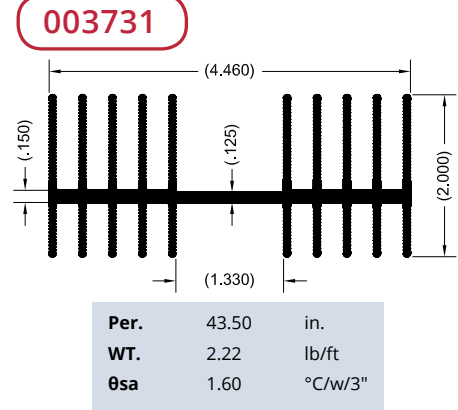
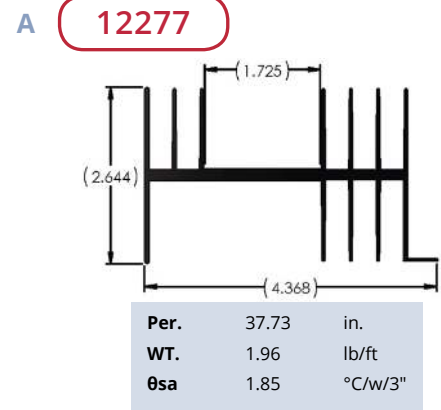

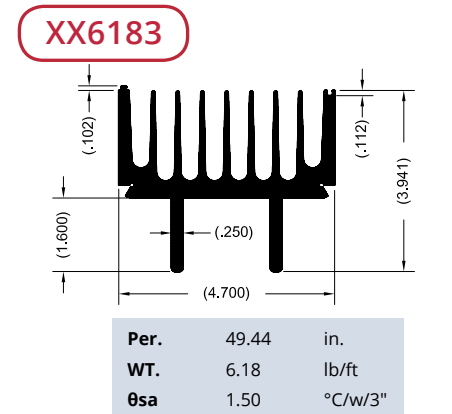
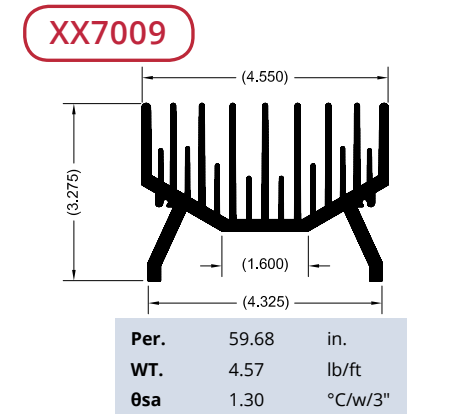
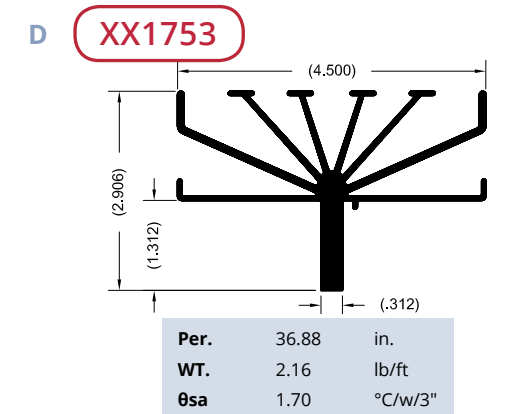
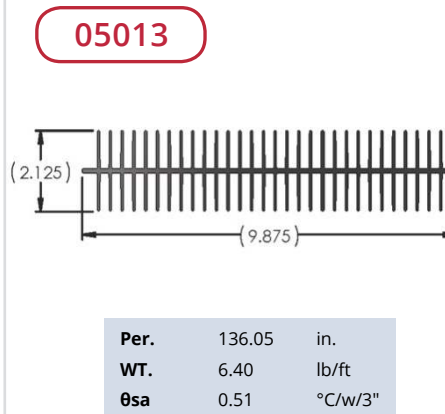
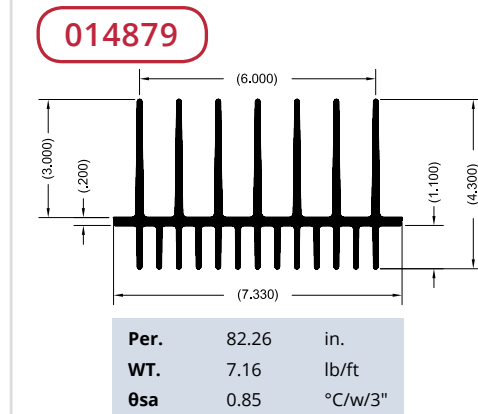
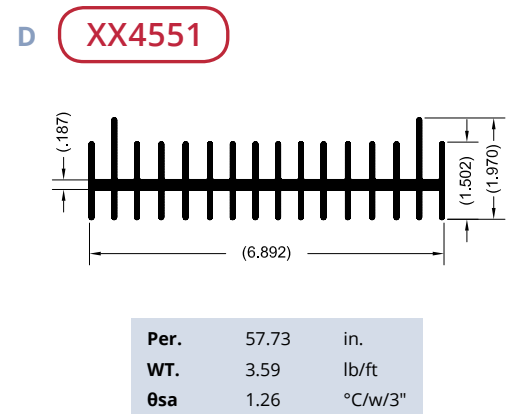
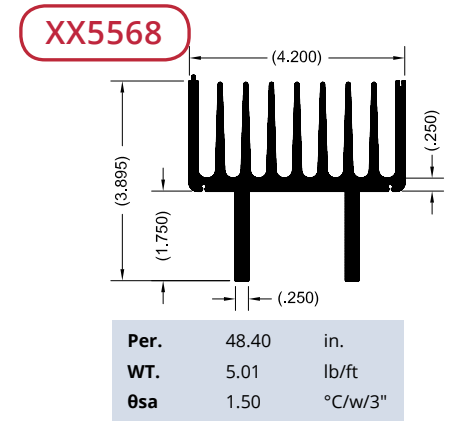
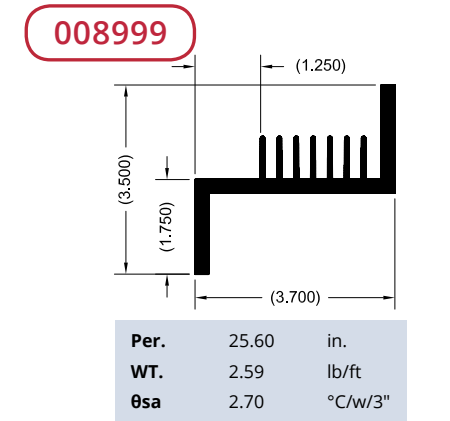
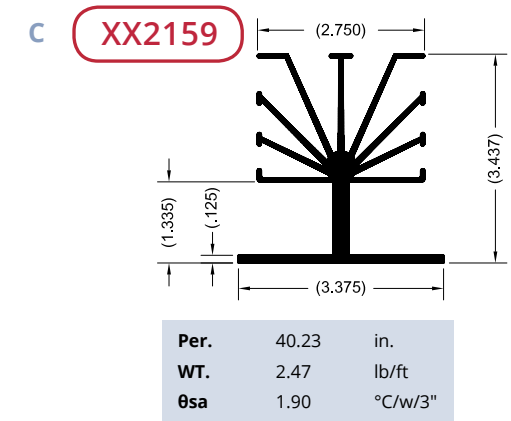
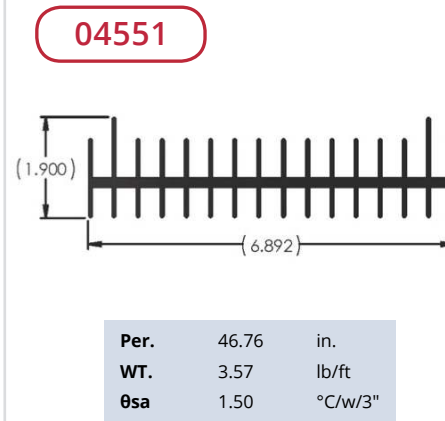
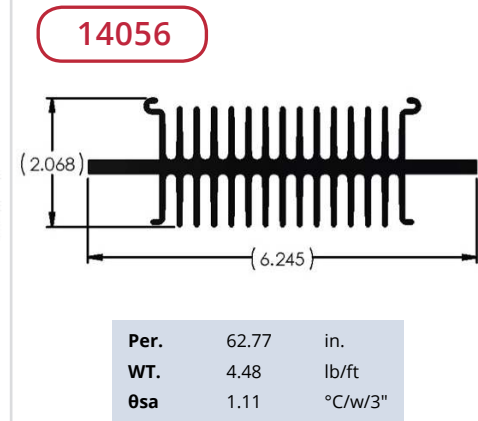
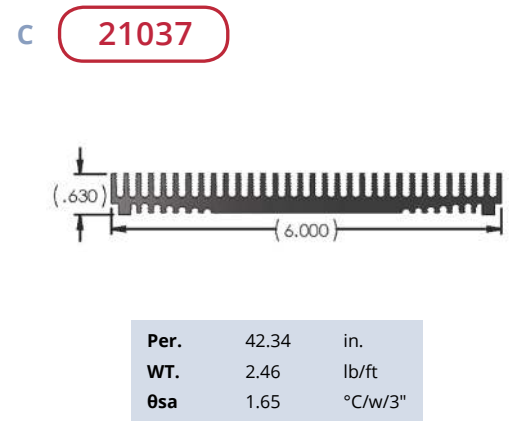
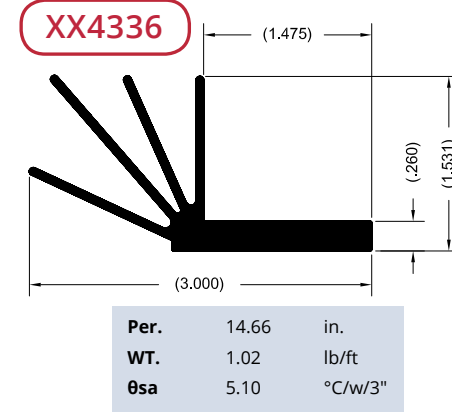
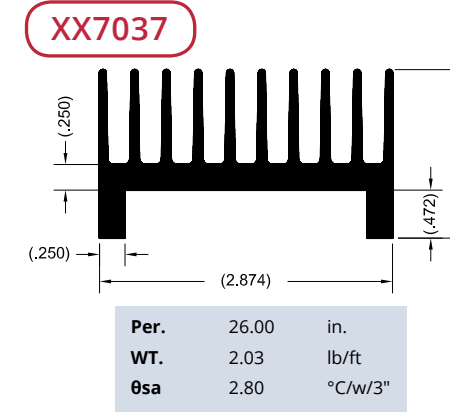
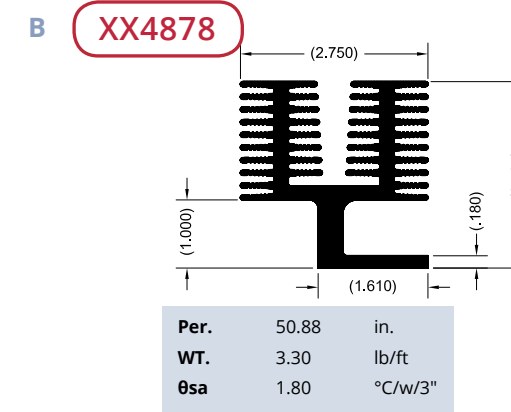
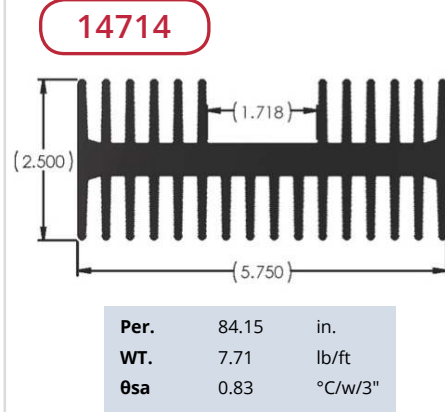
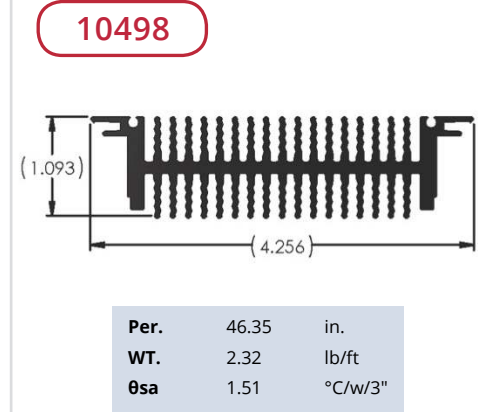
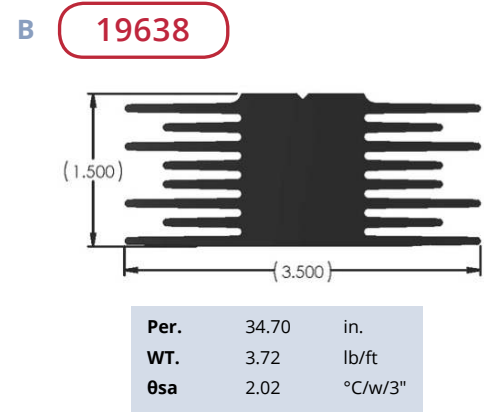
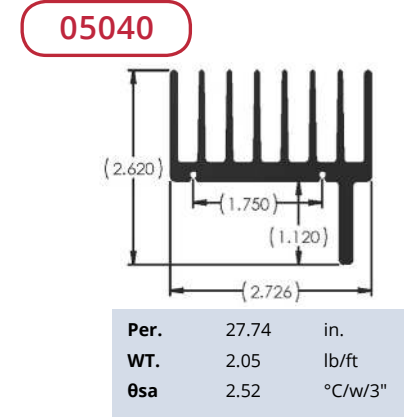
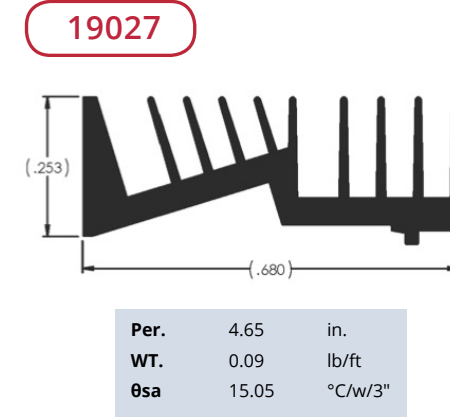
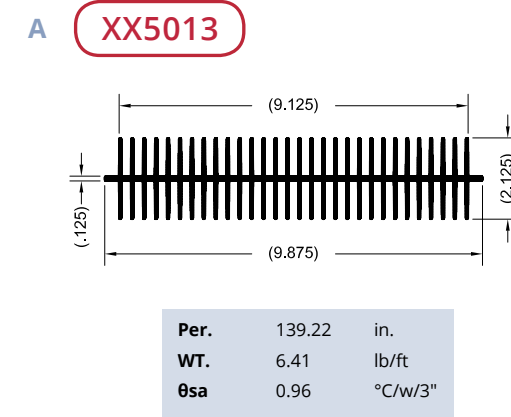
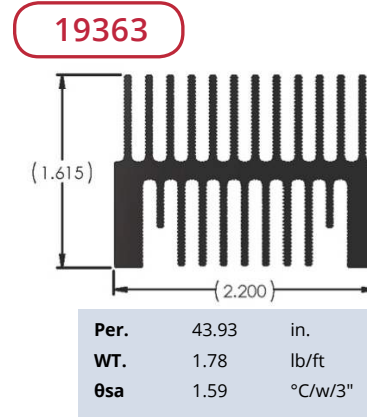
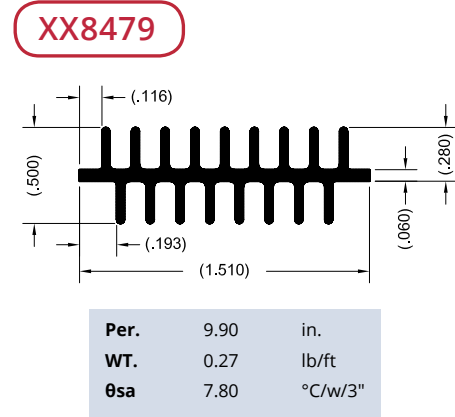
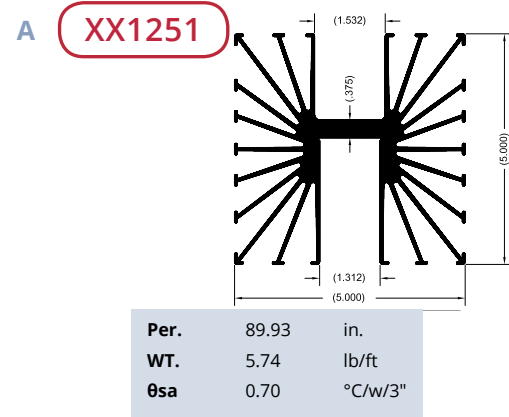

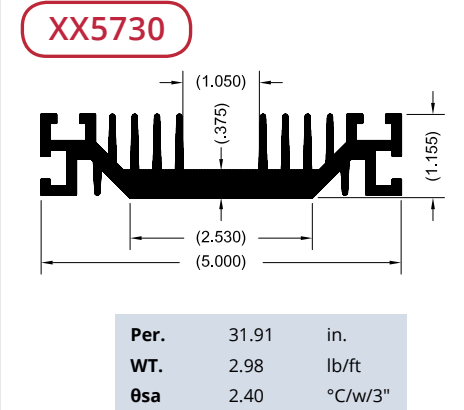
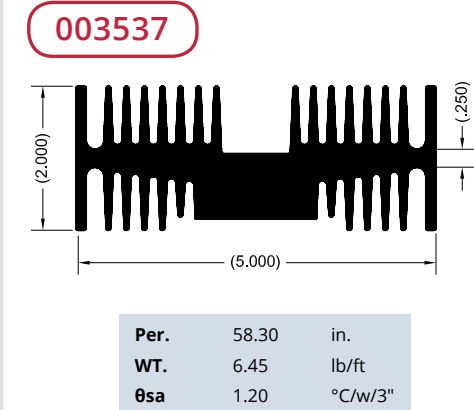
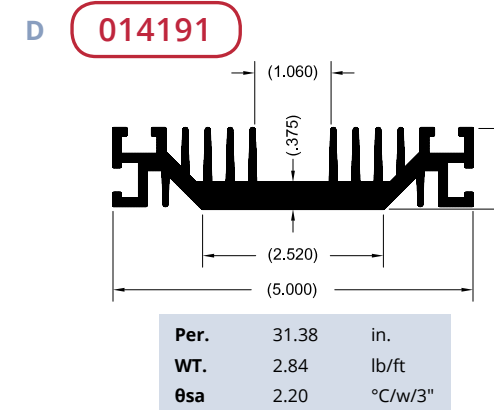
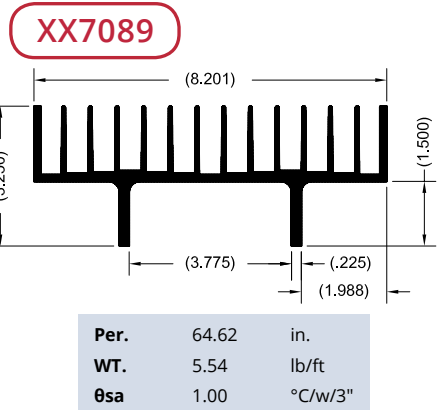
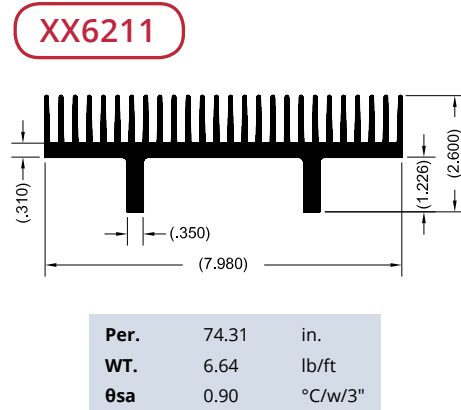
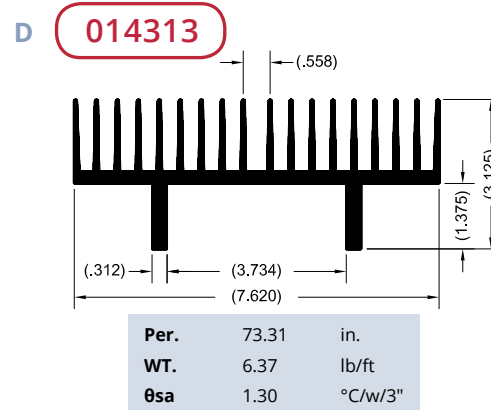
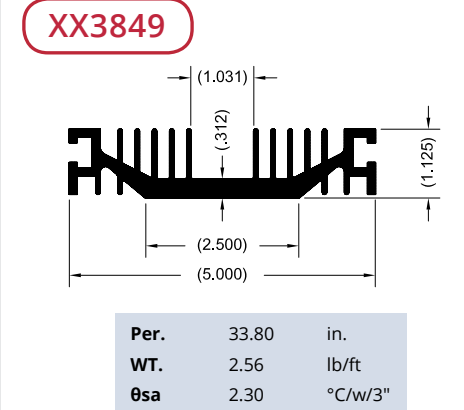
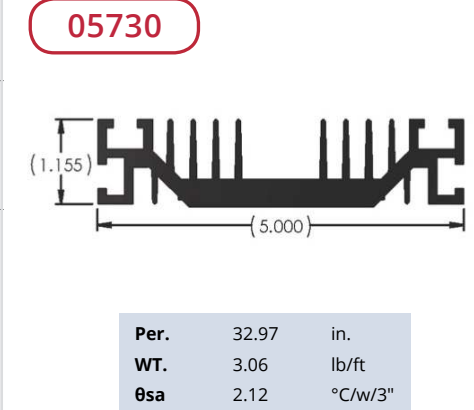
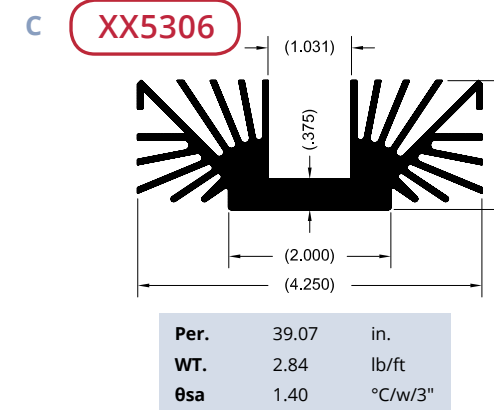
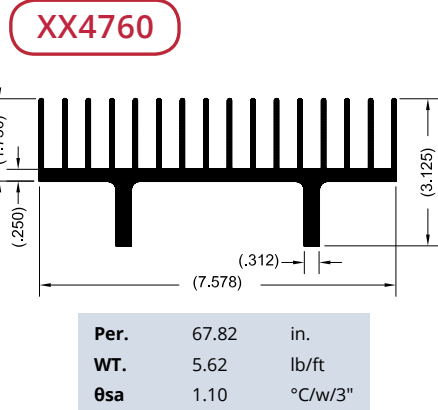
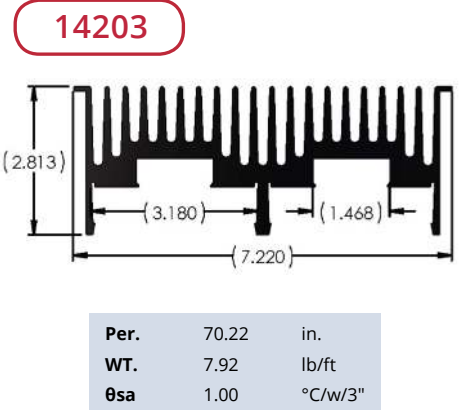
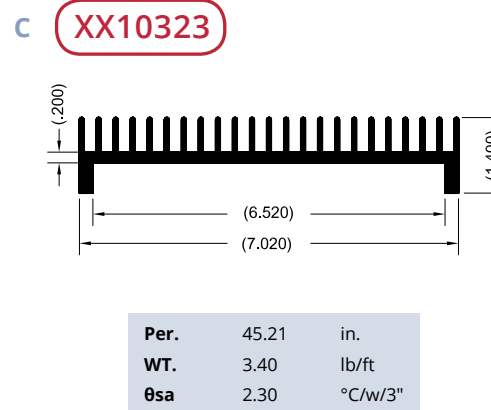
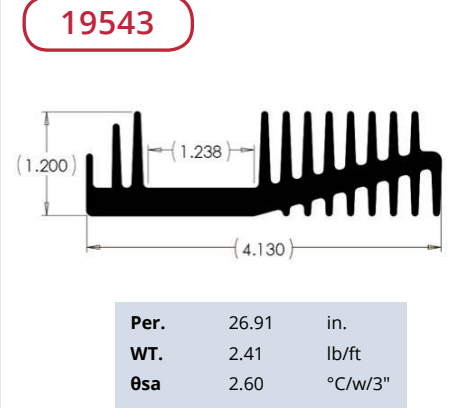
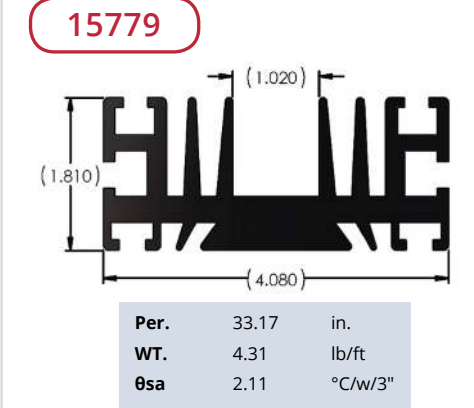
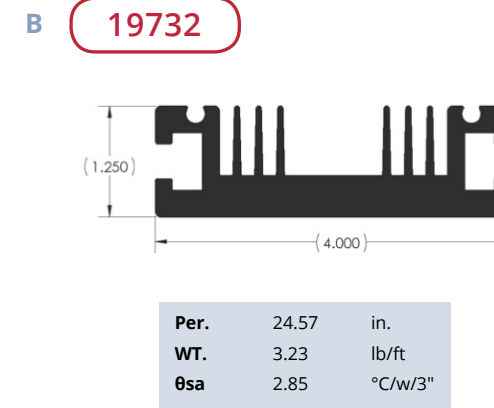
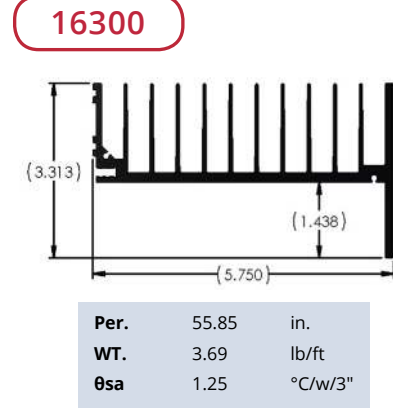
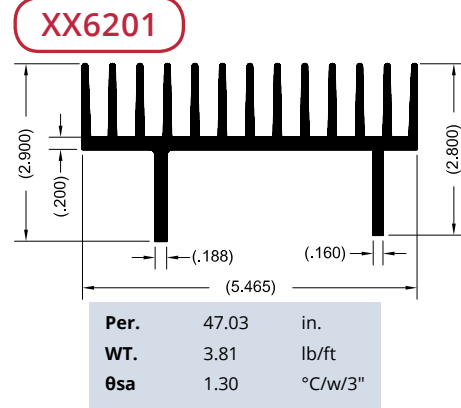
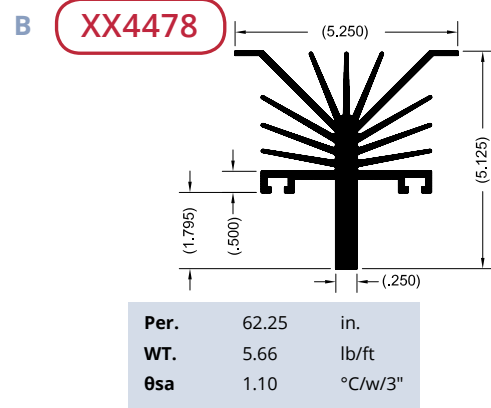
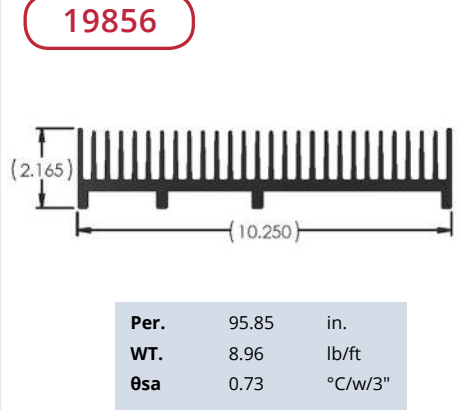
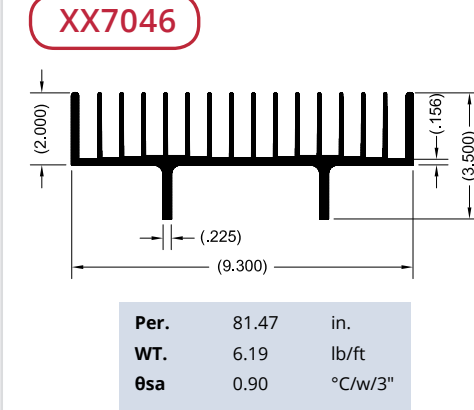
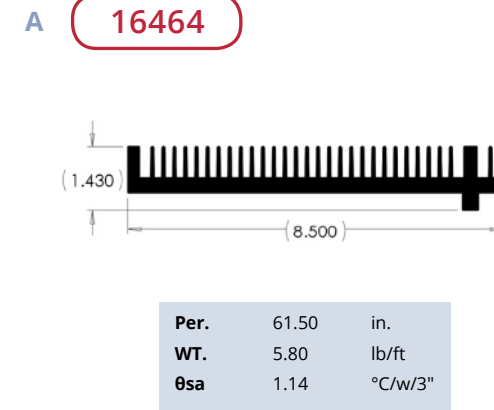
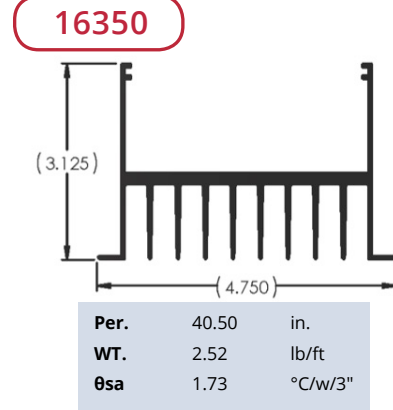
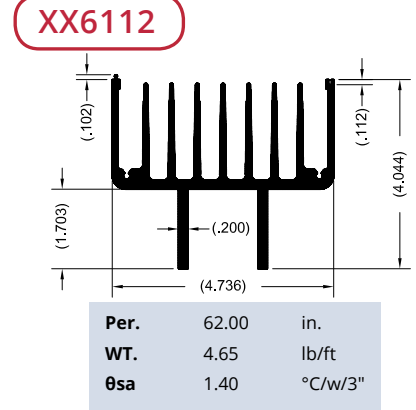
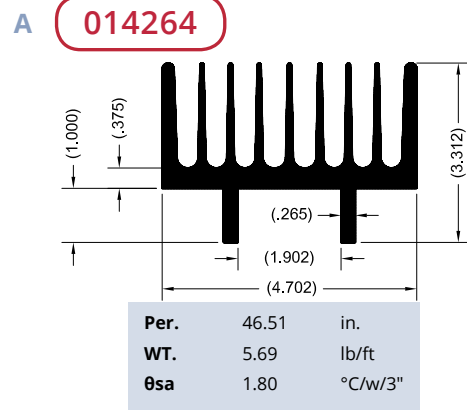

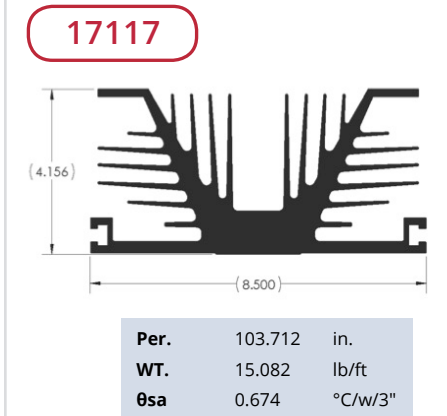
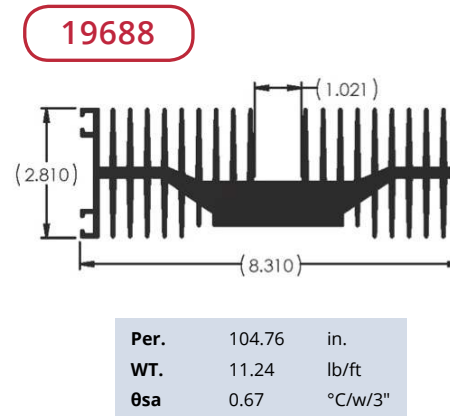
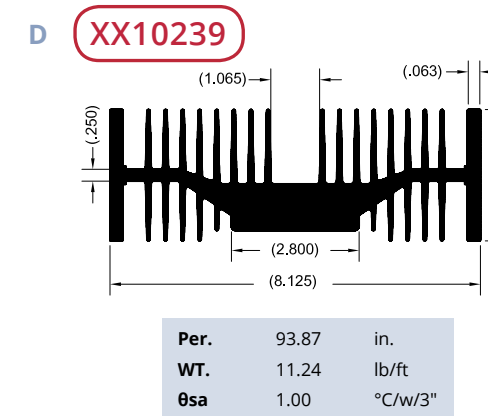
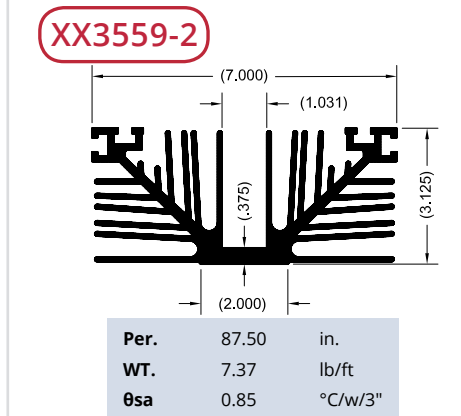
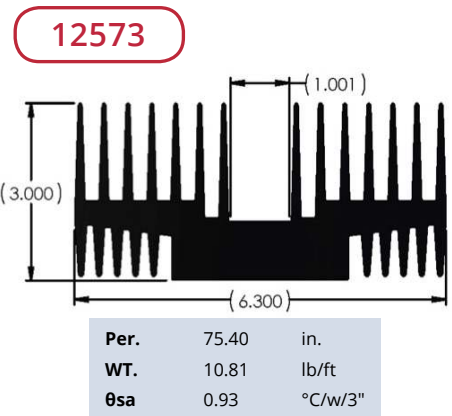
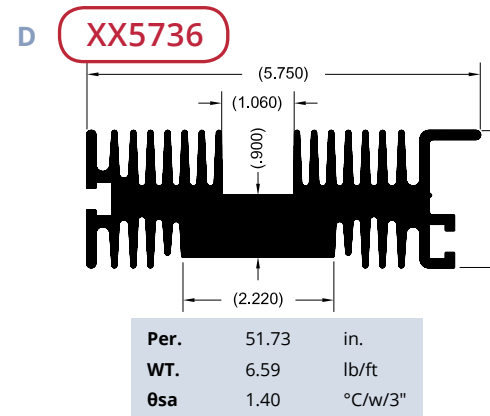
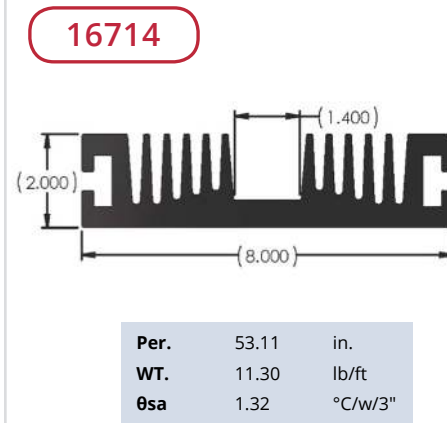
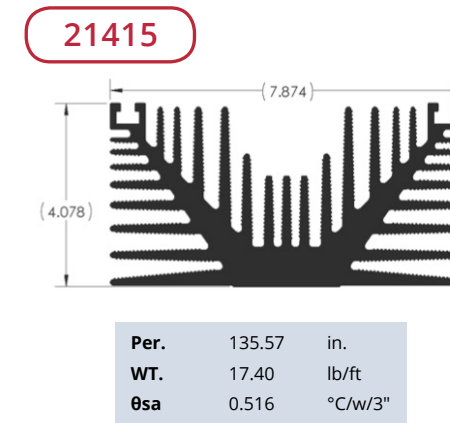
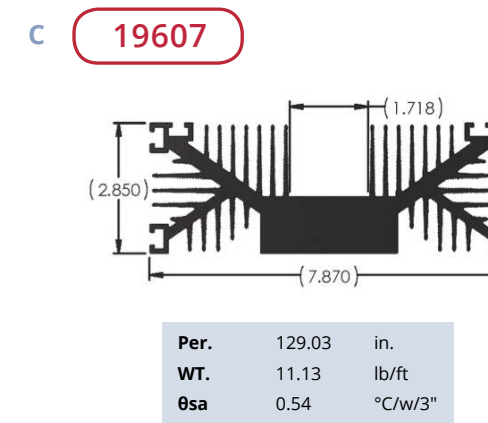
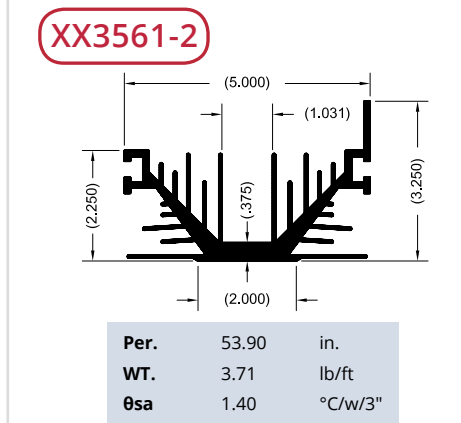
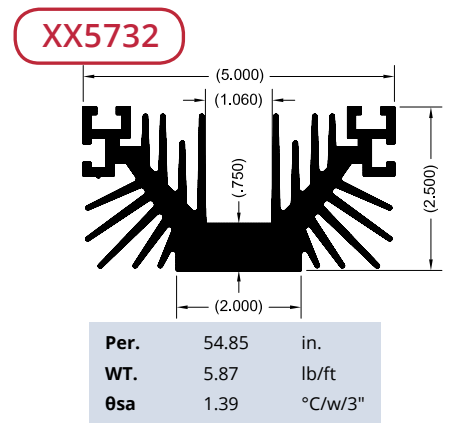
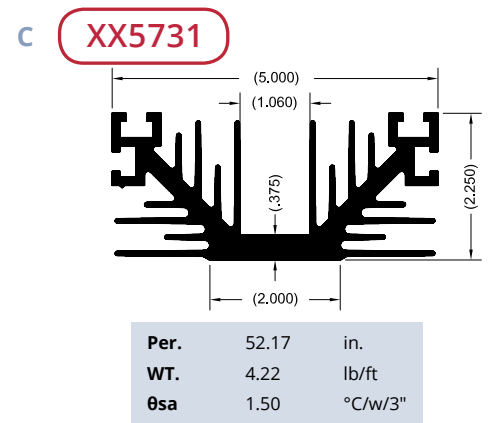
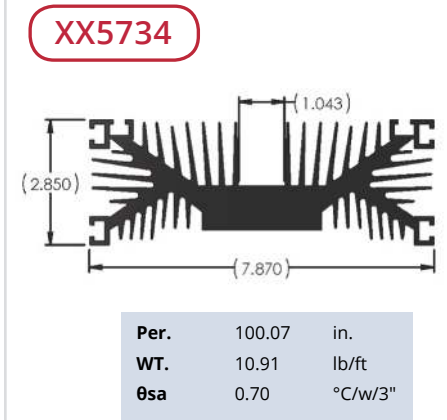
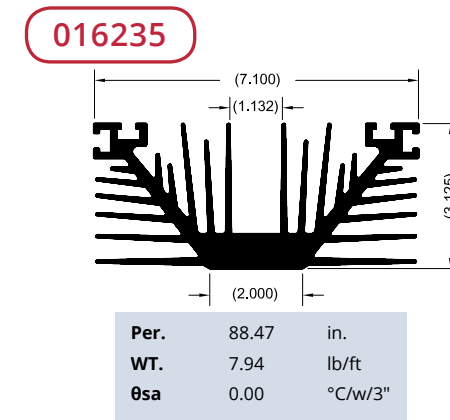
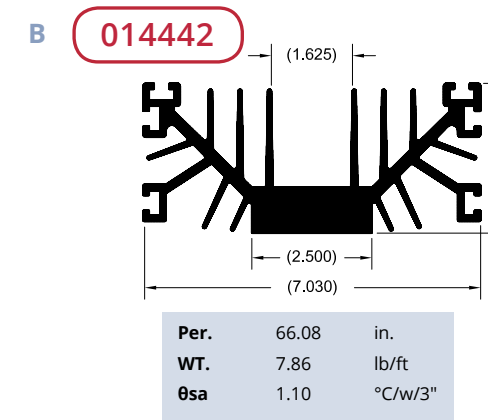
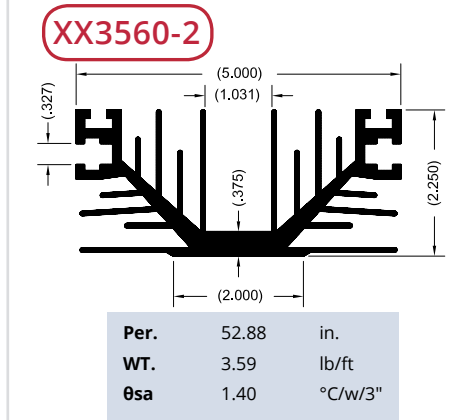
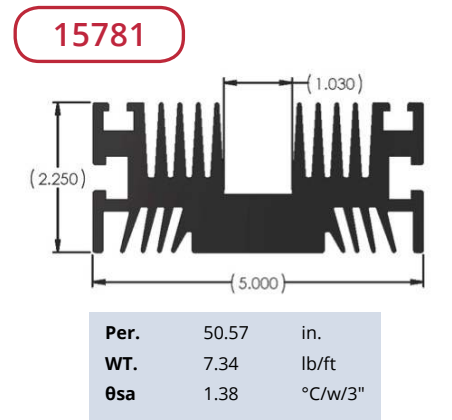
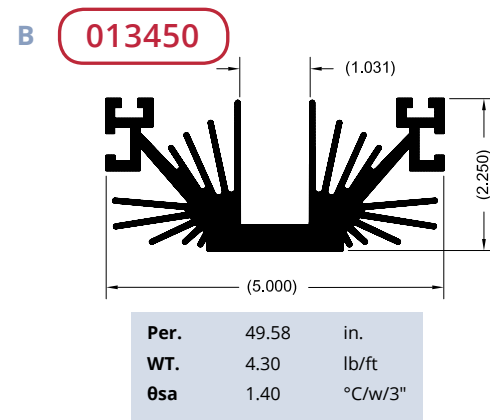
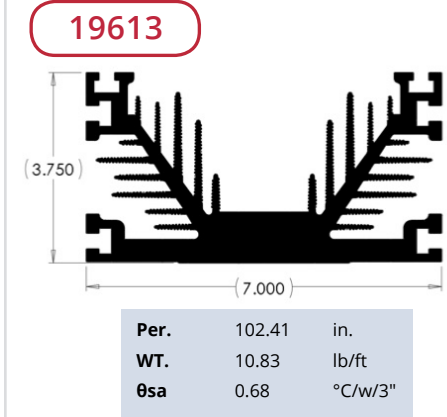
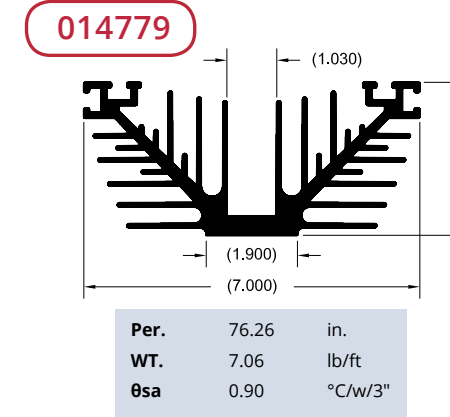
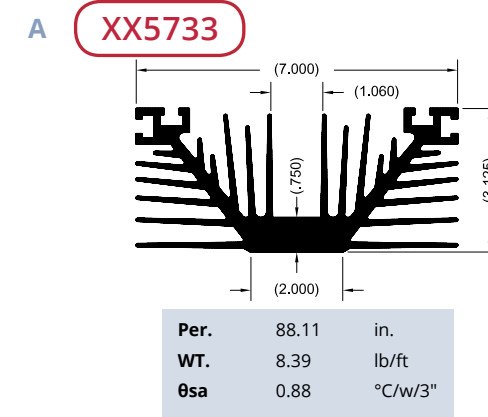
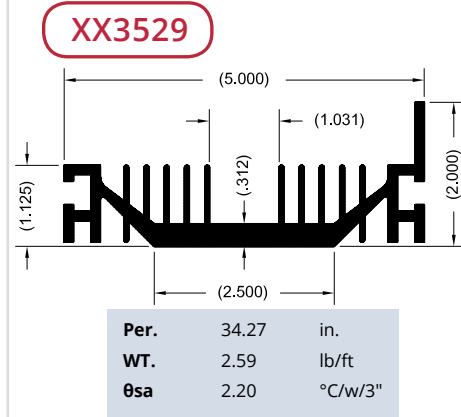
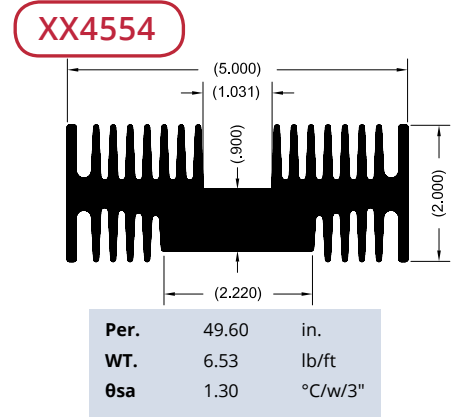
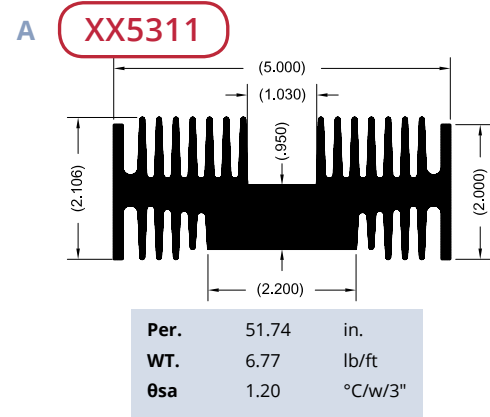



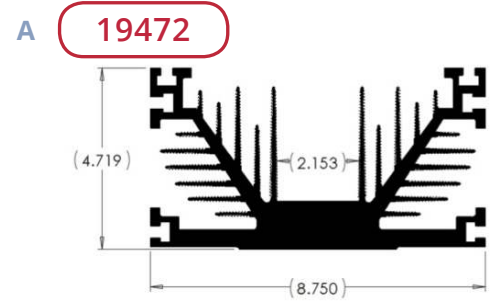

Per. 143.25 in.  
WT. 15.91 lb/ft  
θsa 0.49 °C/w/3"

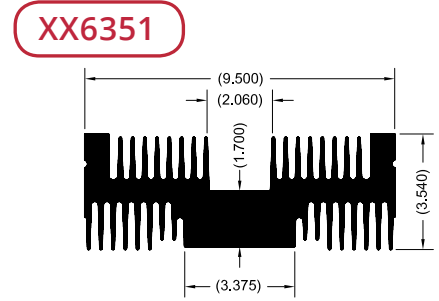

Per. 104.67 in.  
WT. 21.45 lb/ft  
θsa 0.70 °C/w/3"

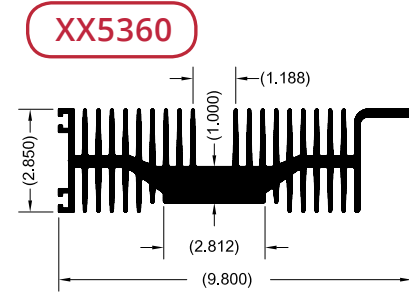

Per. 106.79 in.  
WT. 11.00 lb/ft  
θsa 0.74 °C/w/3"

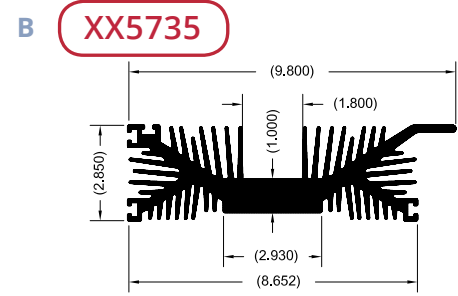

Per. 104.86 in.  
WT. 12.80 lb/ft  
θsa 0.71 °C/w/3"

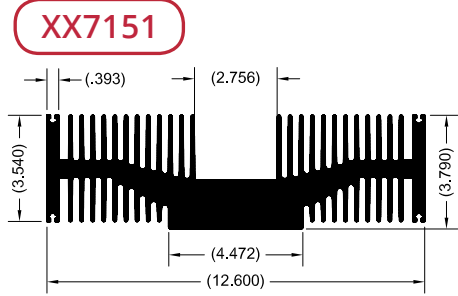

Per. 163.33 in.  
WT. 25.62 lb/ft  
θsa 0.55 °C/w/3"

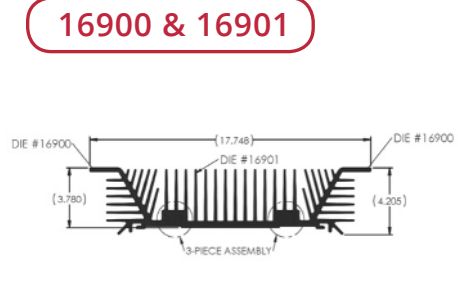

Per. 206.98 in.  
WT. 24.10 lb/ft  
θsa 0.34 °C/w/3"

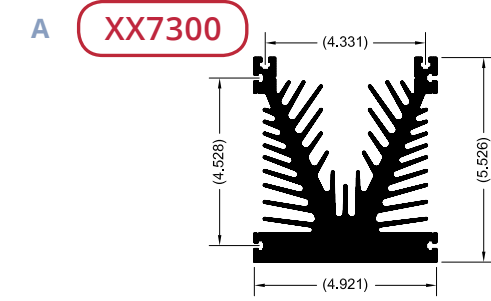

Per. 88.85 in.  
WT. 12.31 lb/ft  
θsa 0.88 °C/w/3"

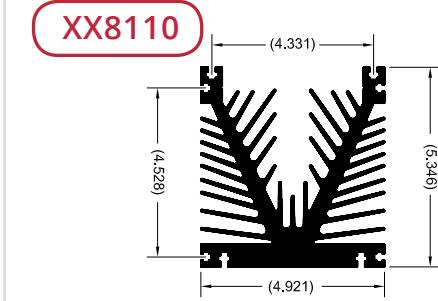

Per. 97.96 in.  
WT. 11.45 lb/ft  
θsa 0.80 °C/w/3"

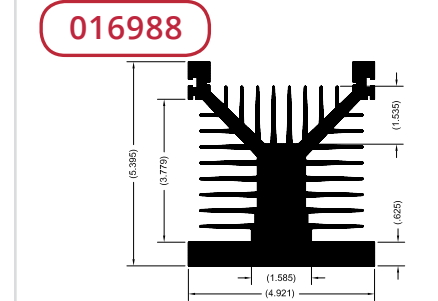

Per. 85.21 in.  
WT. 13.30 lb/ft  
θsa 0.90 °C/w/3"

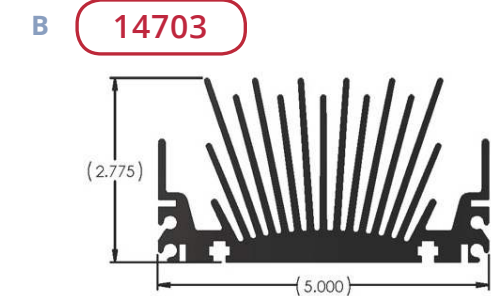

Per. 79.25 in.  
WT. 6.08 lb/ft  
θsa 0.88 °C/w/3"

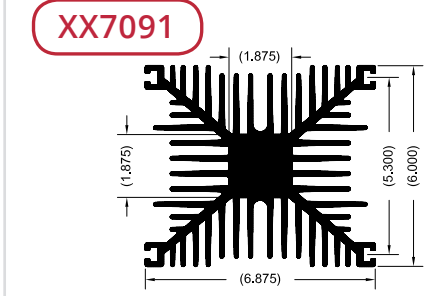

Per. 148.59 in.  
WT. 12.48 lb/ft  
θsa 0.55 °C/w/3"

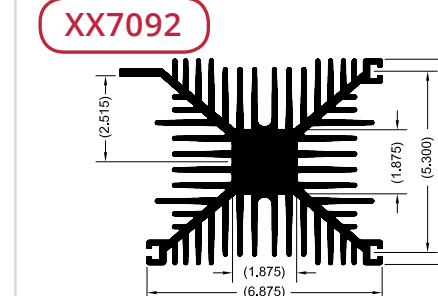

Per. 147.32 in.  
WT. 12.44 lb/ft  
θsa 0.55 °C/w/3"

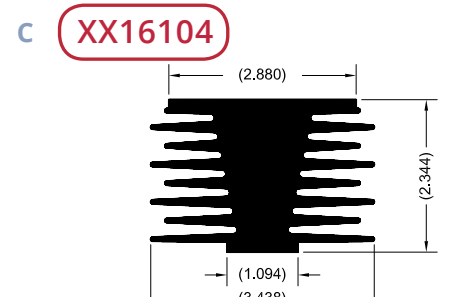

Per. 37.97 in.  
WT. 5.52 lb/ft  
θsa 2.10 °C/w/3"

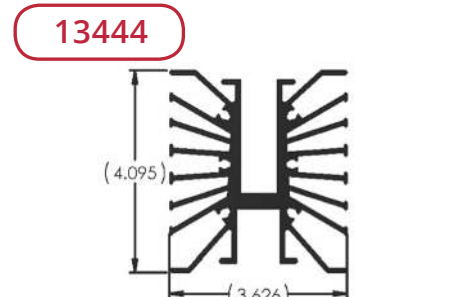

Per. 63.79 in.  
WT. 4.73 lb/ft  
θsa 1.10 °C/w/3"

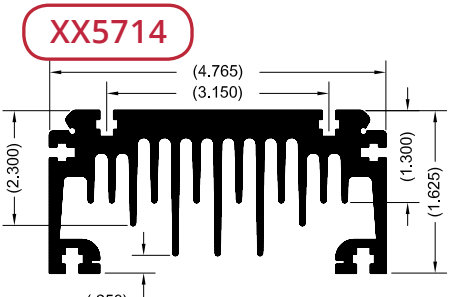

Per. 50.30 in.  
WT. 5.38 lb/ft  
θsa 1.40 °C/w/3"

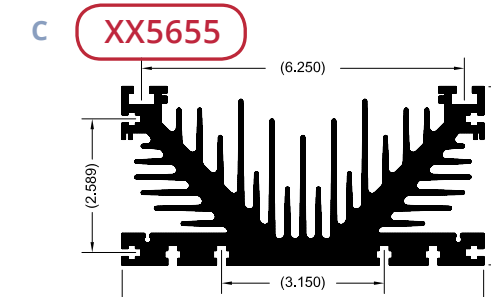

Per. 90.52 in.  
WT. 11.80 lb/ft  
θsa 0.71 °C/w/3"

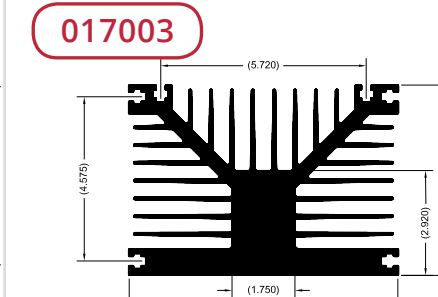

Per. 129.68 in.  
WT. 20.20 lb/ft  
θsa 0.65 °C/w/3"

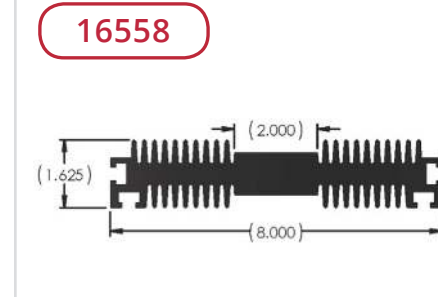

Per. 59.93 in.  
WT. 9.57 lb/ft  
θsa 1.17 °C/w/3"

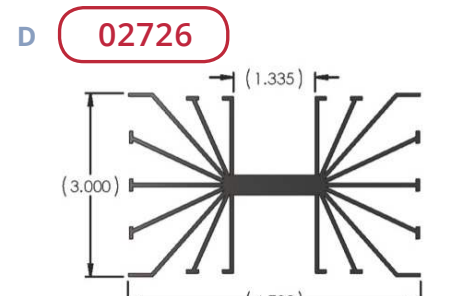

Per. 66.36 in.  
WT. 2.88 lb/ft  
θsa 1.05 °C/w/3"

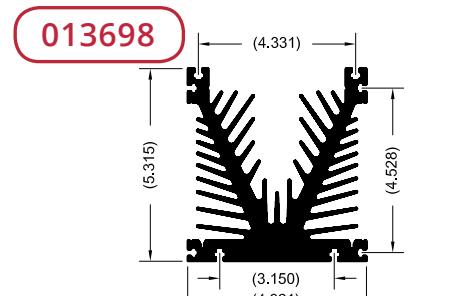

Per. 92.26 in.  
WT. 10.99 lb/ft  
θsa 0.80 °C/w/3"

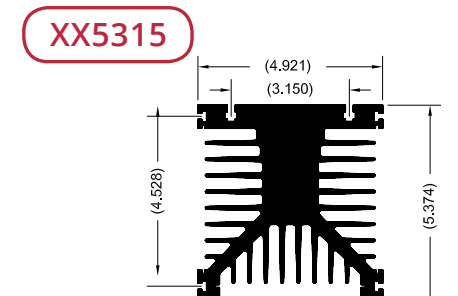

Per. 90.05 in.  
WT. 12.84 lb/ft  
θsa 0.80 °C/w/3"

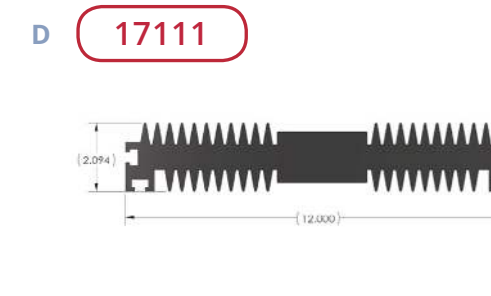

Per. 76.53 in.  
WT. 20.11 lb/ft  
θsa 0.91 °C/w/3"

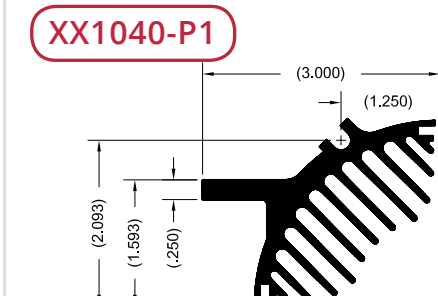

Per. 25.74 in.  
WT. 2.09 lb/ft  
θsa 2.70 °C/w/3"

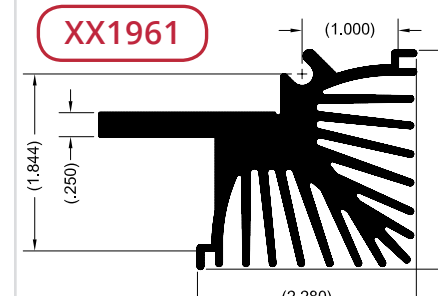

Per. 36.22 in.  
WT. 2.66 lb/ft  
θsa 2.10 °C/w/3"

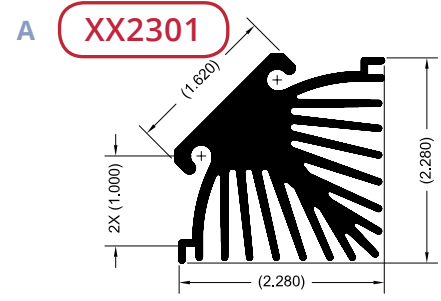

Per.	34.48	in.
WT.	2.48	lb/ft
θsa	2.10	°C/w/3"

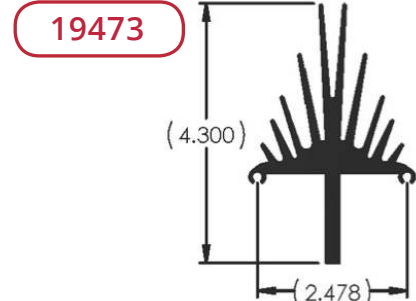

Per.	30.97	in.
WT.	2.85	lb/ft
θsa	2.26	°C/w/3"

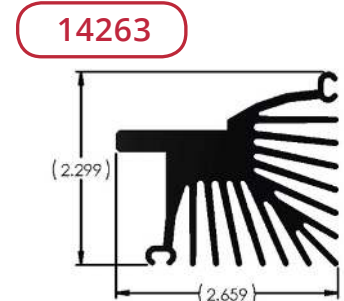

Per.	34.15	in.
WT.	2.51	lb/ft
θsa	2.05	°C/w/3"

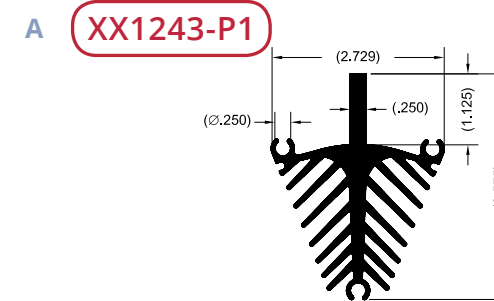

Per.	36.25	in.
WT.	2.53	lb/ft
θsa	2.10	°C/w/3"

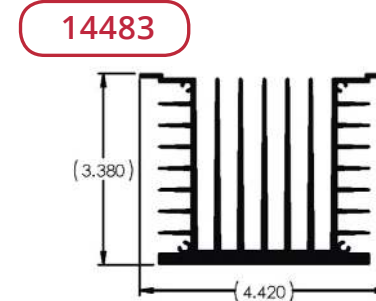

Per.	70.37	in.
WT.	4.32	lb/ft
θsa	0.99	°C/w/3"

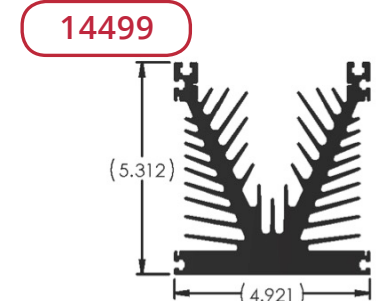

Per.	88.60	in.
WT.	11.46	lb/ft
θsa	0.79	°C/w/3"

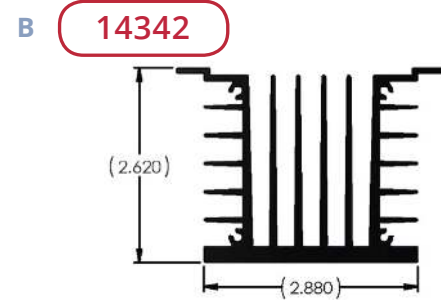

Per.	48.06	in.
WT.	2.88	lb/ft
θsa	1.45	°C/w/3"

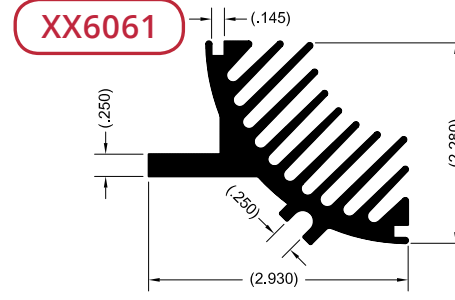

Per.	28.28	in.
WT.	2.23	lb/ft
θsa	2.00	°C/w/3"

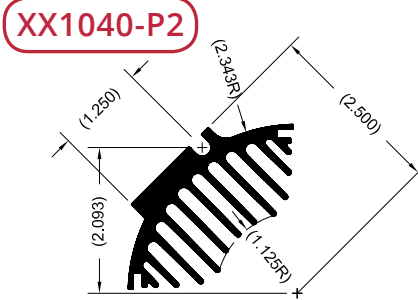

Per.	24.00	in.
WT.	1.87	lb/ft
θsa	2.90	°C/w/3"

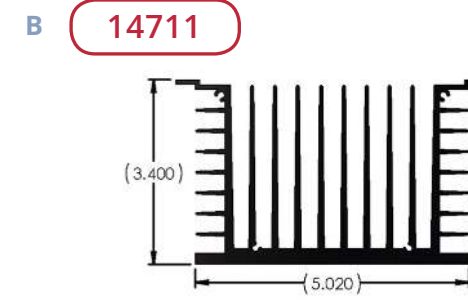

Per.	89.05	in.
WT.	5.95	lb/ft
θsa	0.79	°C/w/3"

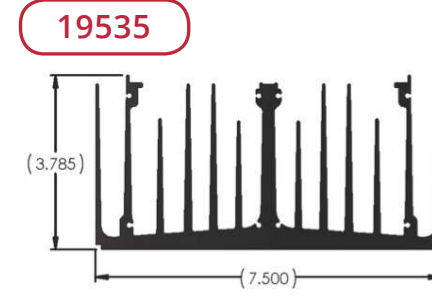

Per.	95.28	in.
WT.	9.50	lb/ft
θsa	0.73	°C/w/3"

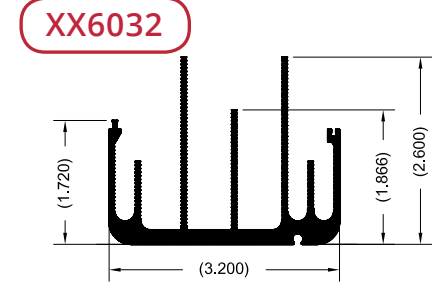

Per.	31.61	in.
WT.	1.75	lb/ft
θsa	2.02	°C/w/3"

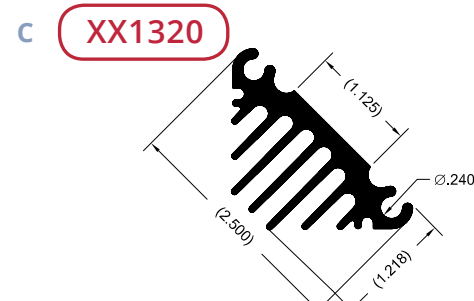

Per.	16.50	in.
WT.	1.36	lb/ft
θsa	3.90	°C/w/3"

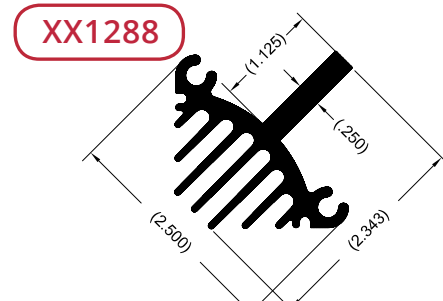

Per.	18.77	in.
WT.	1.41	lb/ft
θsa	3.90	°C/w/3"

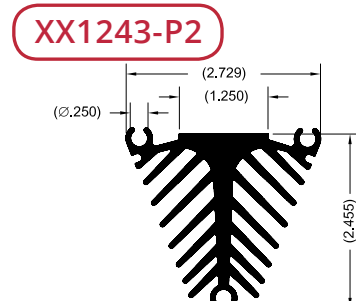

Per.	34.14	in.
WT.	2.24	lb/ft
θsa	2.20	°C/w/3"

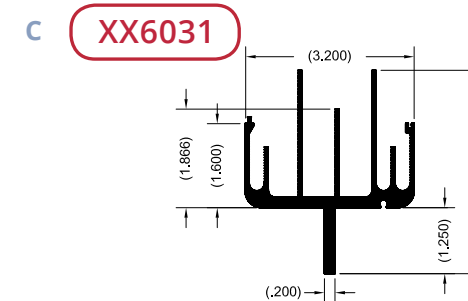

Per.	33.93	in.
WT.	2.06	lb/ft
θsa	2.20	°C/w/3"

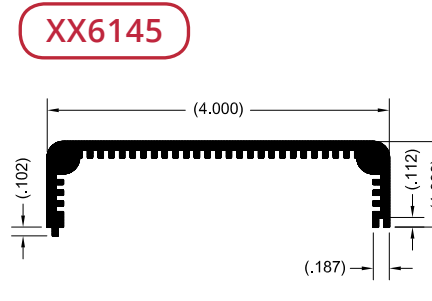

Per.	18.06	in.
WT.	1.03	lb/ft
θsa	2.10	°C/w/3"

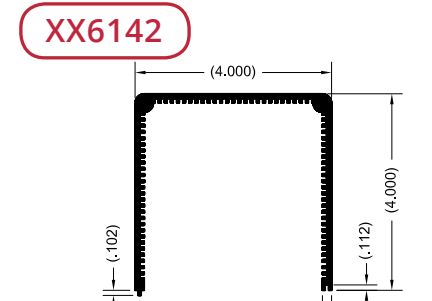

Per.	38.61	in.
WT.	2.05	lb/ft
θsa	1.80	°C/w/3"

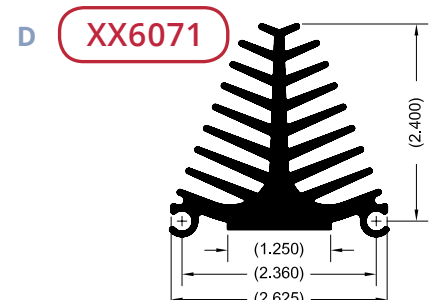

Per.	31.70	in.
WT.	2.45	lb/ft
θsa	1.80	°C/w/3"

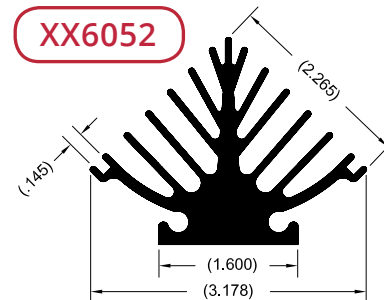

Per.	27.55	in.
WT.	2.19	lb/ft
θsa	1.90	°C/w/3"

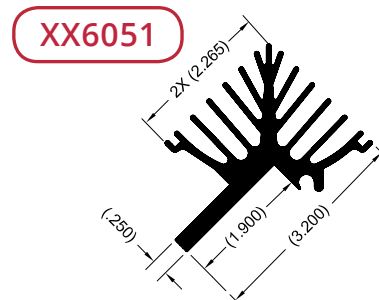

Per.	28.91	in.
WT.	2.18	lb/ft
θsa	1.90	°C/w/3"

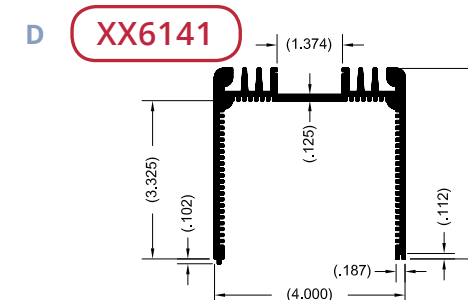

Per.	41.54	in.
WT.	2.57	lb/ft
θsa	1.70	°C/w/3"

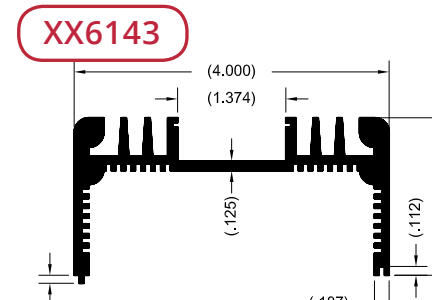

Per.	27.55	in.
WT.	1.92	lb/ft
θsa	1.90	°C/w/3"

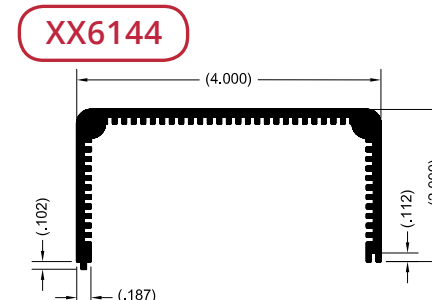

Per.	24.66	in.
WT.	1.37	lb/ft
θsa	2.00	°C/w/3"

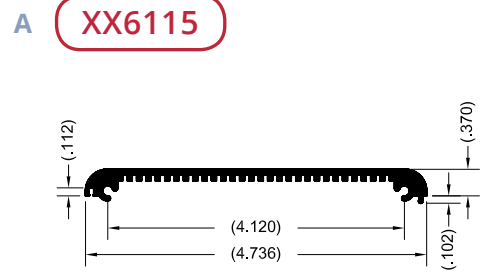

Per.	16.06	in.
WT.	0.87	lb/ft
θsa	3.10	°C/w/3"

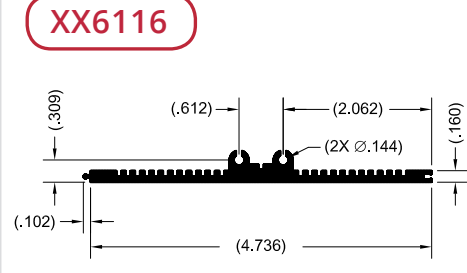

Per.	15.79	in.
WT.	0.90	lb/ft
θsa	3.10	°C/w/3"

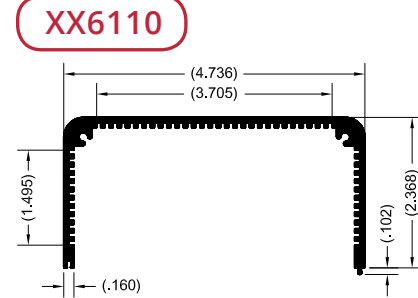

Per.	27.72	in.
WT.	1.50	lb/ft
θsa	2.00	°C/w/3"

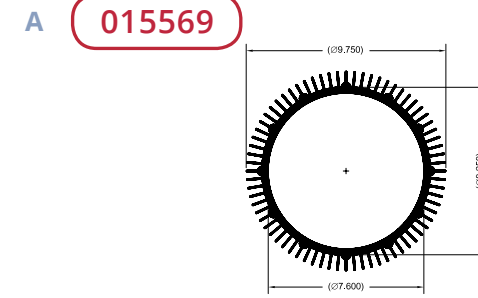

Per.	153.16	in.
WT.	15.66	lb/ft
θsa	0.90	°C/w/3"

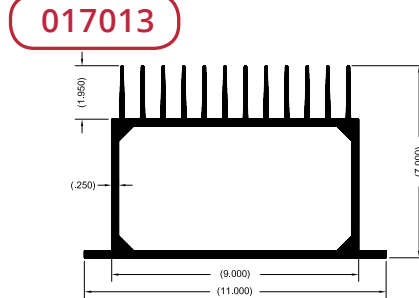

Per.	101.85	in.
WT.	12.90	lb/ft
θsa	0.95	°C/w/3"

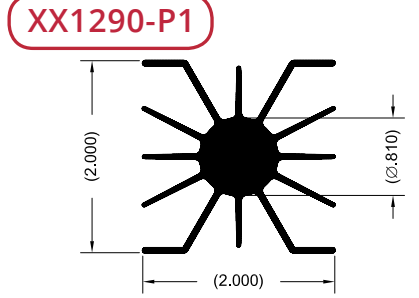

Per.	23.00	in.
WT.	0.97	lb/ft
θsa	2.50	°C/w/3"

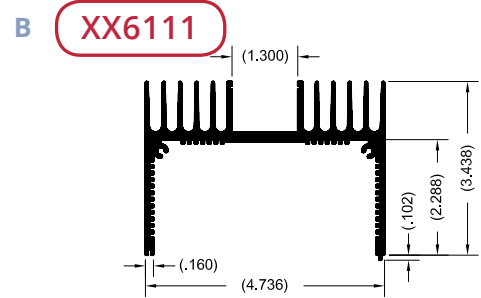

Per.	48.90	in.
WT.	2.95	lb/ft
θsa	1.60	°C/w/3"

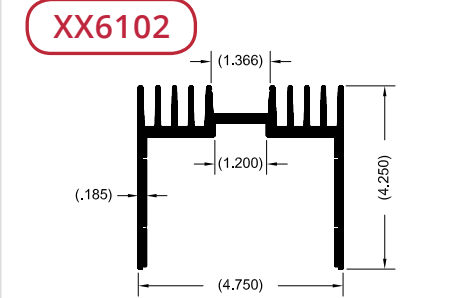

Per.	41.15	in.
WT.	3.79	lb/ft
θsa	1.90	°C/w/3"

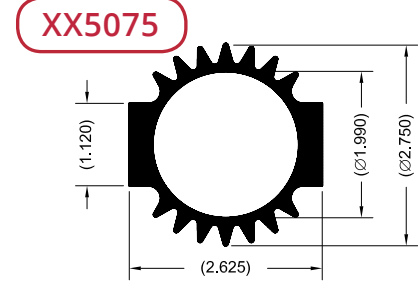

Per.	19.85	in.
WT.	2.14	lb/ft
θsa	3.90	°C/w/3"

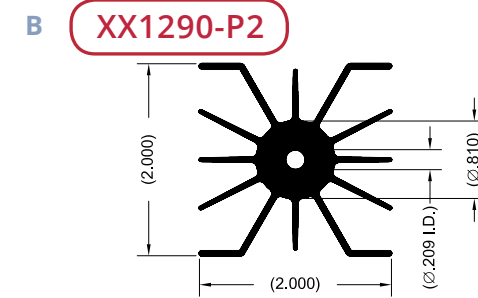

Per.	23.18	in.
WT.	0.93	lb/ft
θsa	2.50	°C/w/3"

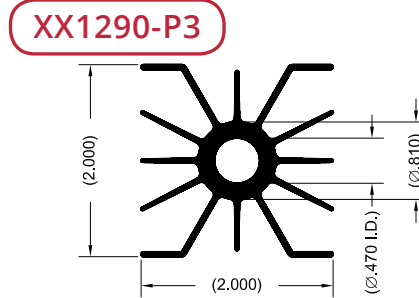

Per.	23.98	in.
WT.	0.77	lb/ft
θsa	2.50	°C/w/3"

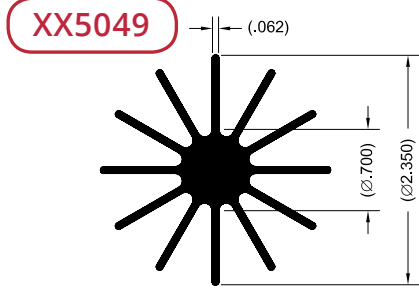

Per.	21.17	in.
WT.	1.22	lb/ft
θsa	2.10	°C/w/3"

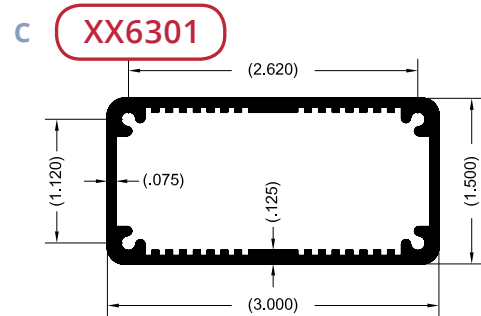

Per.	21.07	in.
WT.	0.90	lb/ft
θsa	3.50	°C/w/3"

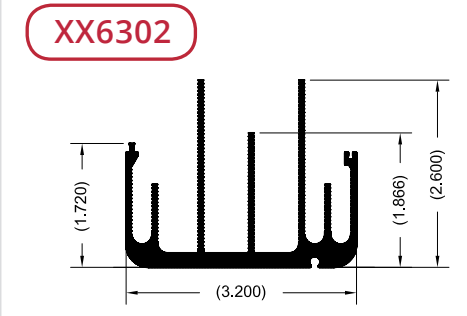

Per.	31.61	in.
WT.	1.75	lb/ft
θsa	2.02	°C/w/3"

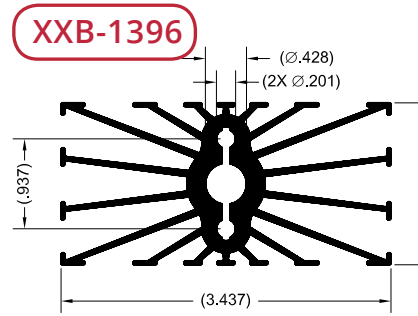

Per.	41.34	in.
WT.	1.75	lb/ft
θsa	2.20	°C/w/3"

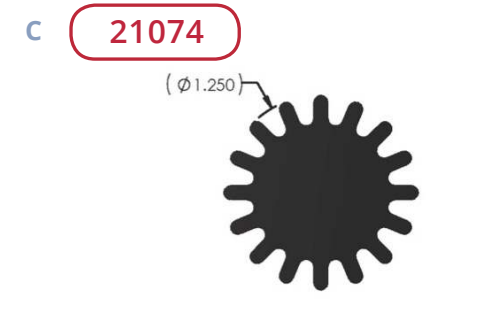

Per.	7.72	in.
WT.	1.05	lb/ft
θsa	9.06	°C/w/3"

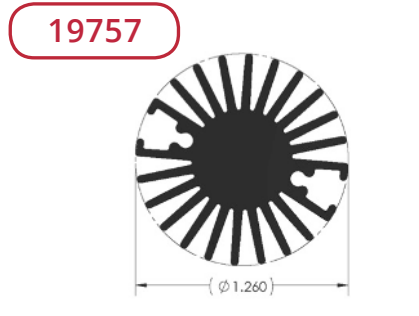

Per.	16.29	in.
WT.	0.76	lb/ft
θsa	4.29	°C/w/3"

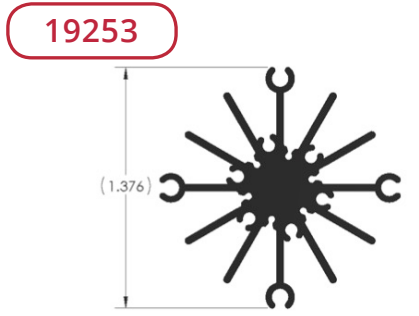

Per.	14.08	in.
WT.	0.45	lb/ft
θsa	4.97	°C/w/3"

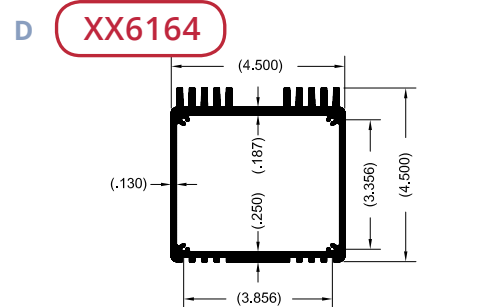

Per.	45.33	in.
WT.	4.26	lb/ft
θsa	1.60	°C/w/3"

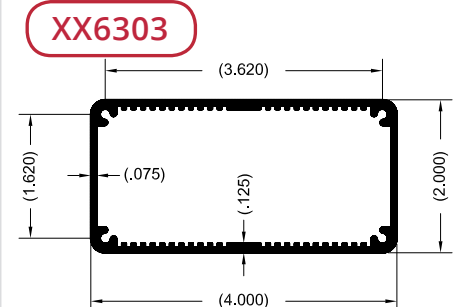

Per.	28.62	in.
WT.	1.40	lb/ft
θsa	3.90	°C/w/3"

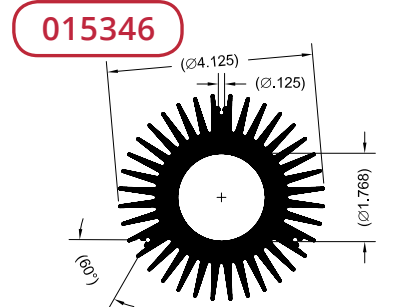

Per.	62.02	in.
WT.	6.47	lb/ft
θsa	1.60	°C/w/3"

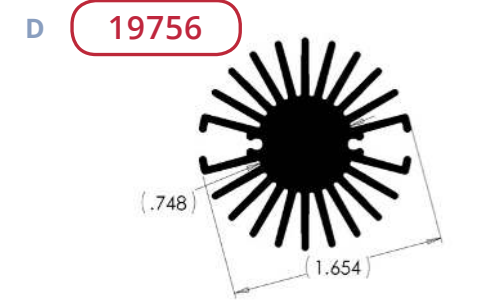

Per.	22.20	in.
WT.	1.21	lb/ft
θsa	3.15	°C/w/3"

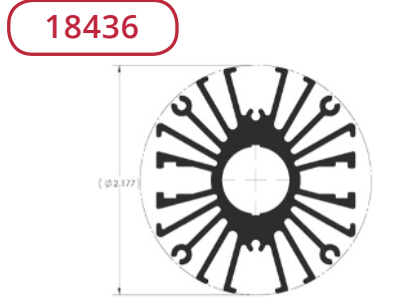

Per.	32.13	in.
WT.	1.35	lb/ft
θsa	2.18	°C/w/3"

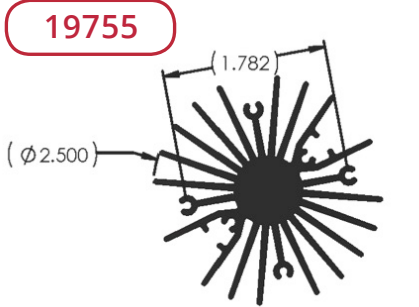

Per.	39.98	in.
WT.	1.97	lb/ft
θsa	1.75	°C/w/3"



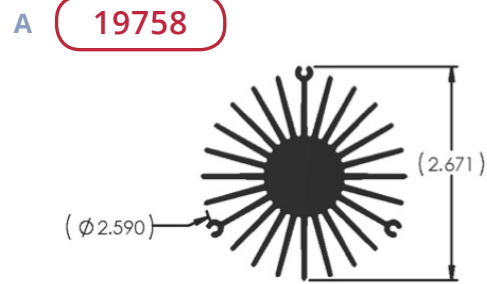

Per.	41.59	in.
WT.	2.39	lb/ft
θsa	1.68	°C/w/3"

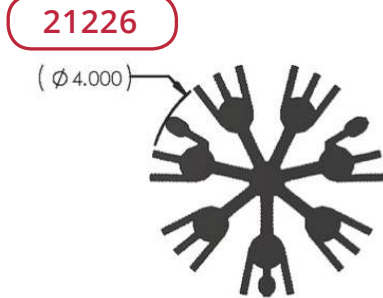

Per.	47.15	in.
WT.	5.64	lb/ft
θsa	1.48	°C/w/3"

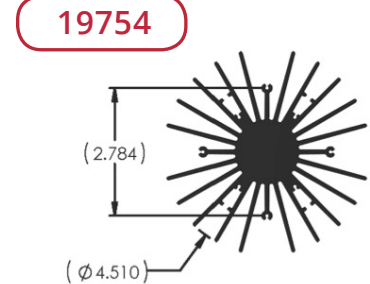

Per.	72.55	in.
WT.	5.02	lb/ft
θsa	0.96	°C/w/3"

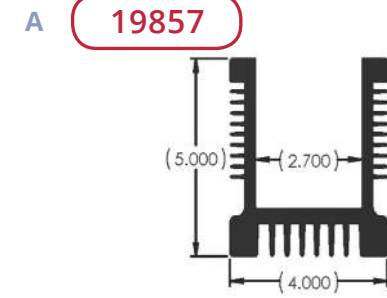

Per.	49.06	in.
WT.	7.54	lb/ft
θsa	1.43	°C/w/3"

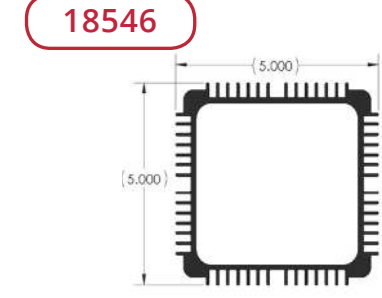

Per.	70.99	in.
WT.	4.96	lb/ft
θsa	0.98	°C/w/3"

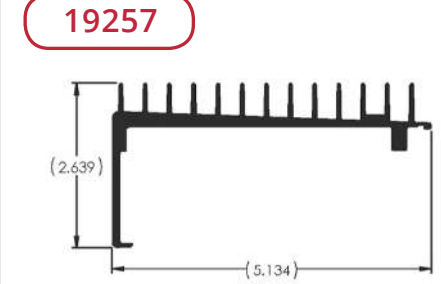

Per.	28.46	in.
WT.	2.04	lb/ft
θsa	2.46	°C/w/3"

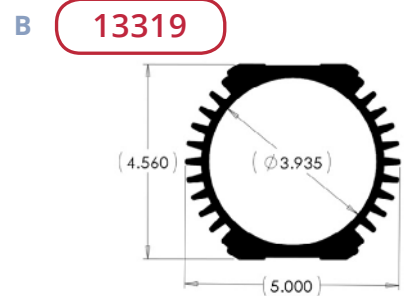

Per.	39.94	in.
WT.	5.90	lb/ft
θsa	1.75	°C/w/3"

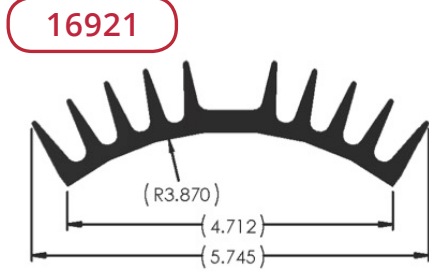

Per.	25.10	in.
WT.	2.93	lb/ft
θsa	2.79	°C/w/3"

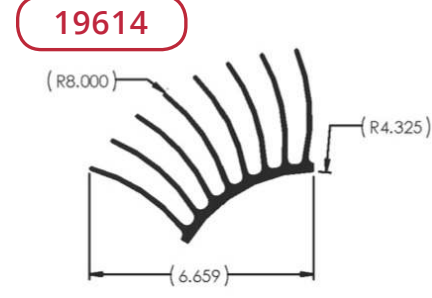

Per.	63.45	in.
WT.	6.04	lb/ft
θsa	1.10	°C/w/3"

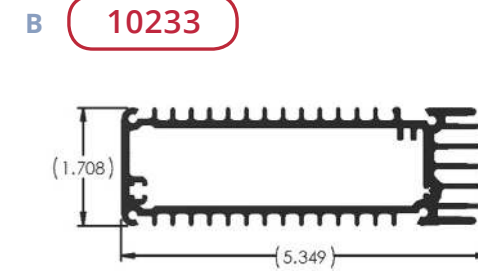

Per.	43.52	in.
WT.	2.58	lb/ft
θsa	1.61	°C/w/3"

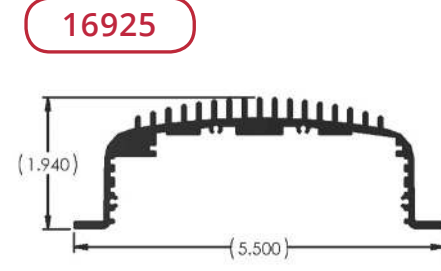

Per.	27.11	in.
WT.	1.92	lb/ft
θsa	2.58	°C/w/3"

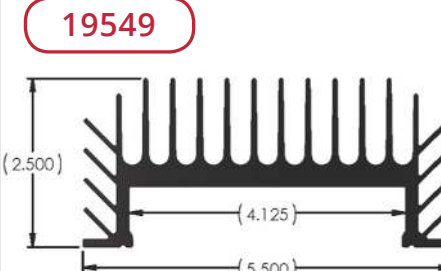

Per.	52.62	in.
WT.	4.17	lb/ft
θsa	1.33	°C/w/3"

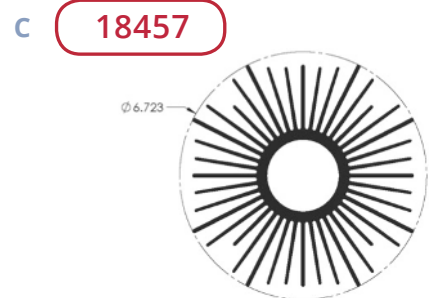

Per.	158.40	in.
WT.	9.37	lb/ft
θsa	0.44	°C/w/3"



Per.	153.13	in.
WT.	15.66	lb/ft
θsa	0.46	°C/w/3"

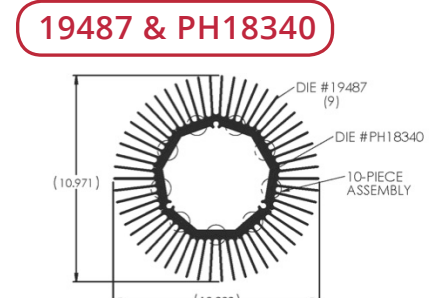

Per.	311.01	in.
WT.	25.59	lb/ft
θsa	0.22	°C/w/3"

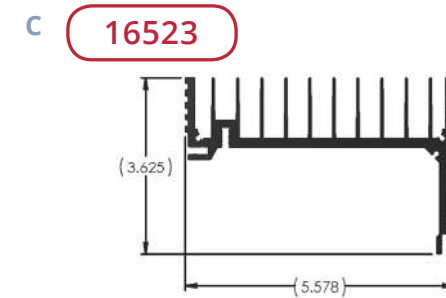

Per.	51.00	in.
WT.	3.38	lb/ft
θsa	1.37	°C/w/3"

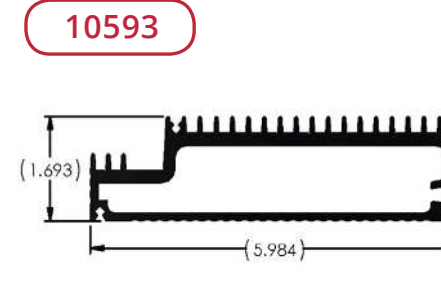

Per.	40.28	in.
WT.	3.43	lb/ft
θsa	1.74	°C/w/3"

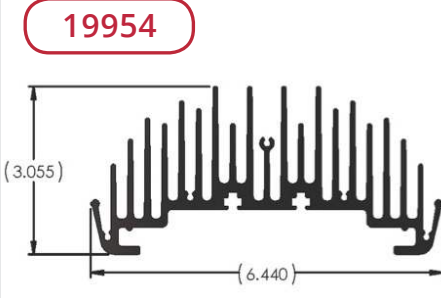

Per.	78.90	in.
WT.	5.55	lb/ft
θsa	0.89	°C/w/3"

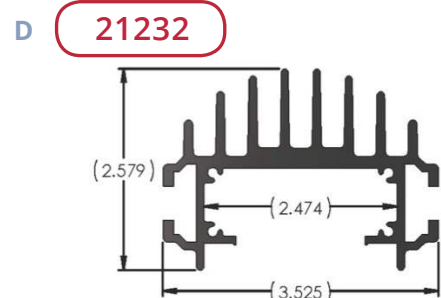

Per.	30.59	in.
WT.	2.33	lb/ft
θsa	2.29	°C/w/3"

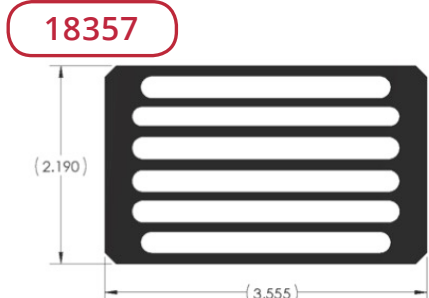

Per.	47.69	in.
WT.	4.25	lb/ft
θsa	1.47	°C/w/3"

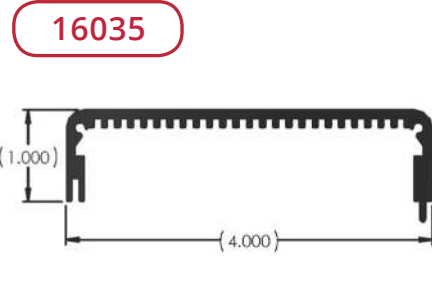

Per.	17.40	in.
WT.	1.05	lb/ft
θsa	4.02	°C/w/3"

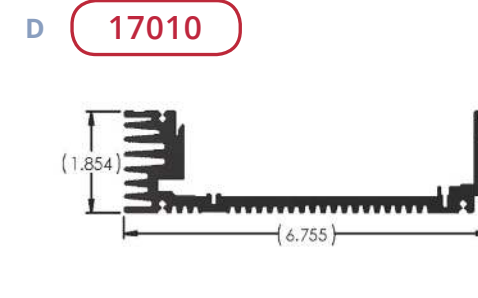

Per.	39.79	in.
WT.	3.31	lb/ft
θsa	1.76	°C/w/3"

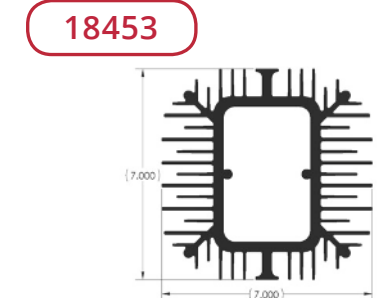

Per.	139.00	in.
WT.	13.95	lb/ft
θsa	0.50	°C/w/3"

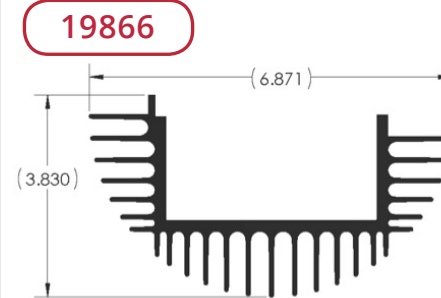

Per.	61.60	in.
WT.	4.60	lb/ft
θsa	1.14	°C/w/3"



A

18395



<b>Per.</b>	40.24	in.
<b>WT.</b>	2.94	lb/ft
<b>θsa</b>	1.74	°C/w/3"

16517

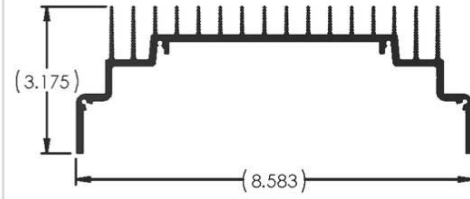

<b>Per.</b>	52.66	in.
<b>WT.</b>	3.22	lb/ft
<b>θsa</b>	1.33	°C/w/3"

19384

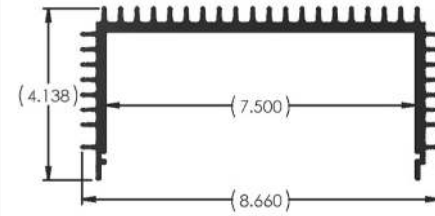

<b>Per.</b>	68.16	in.
<b>WT.</b>	5.89	lb/ft
<b>θsa</b>	1.03	°C/w/3"

B

17013

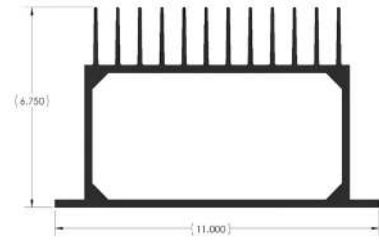

<b>Per.</b>	100.85	in.
<b>WT.</b>	12.75	lb/ft
<b>θsa</b>	0.69	°C/w/3"

# HIGH ASPECT RATIO THERMAL EXTRUSIONS

---

*12 Inch High Aspect Ratio Thermal Extrusions* ..... 280-285

*High Aspect Ratio Thermal Extrusions* ..... 286

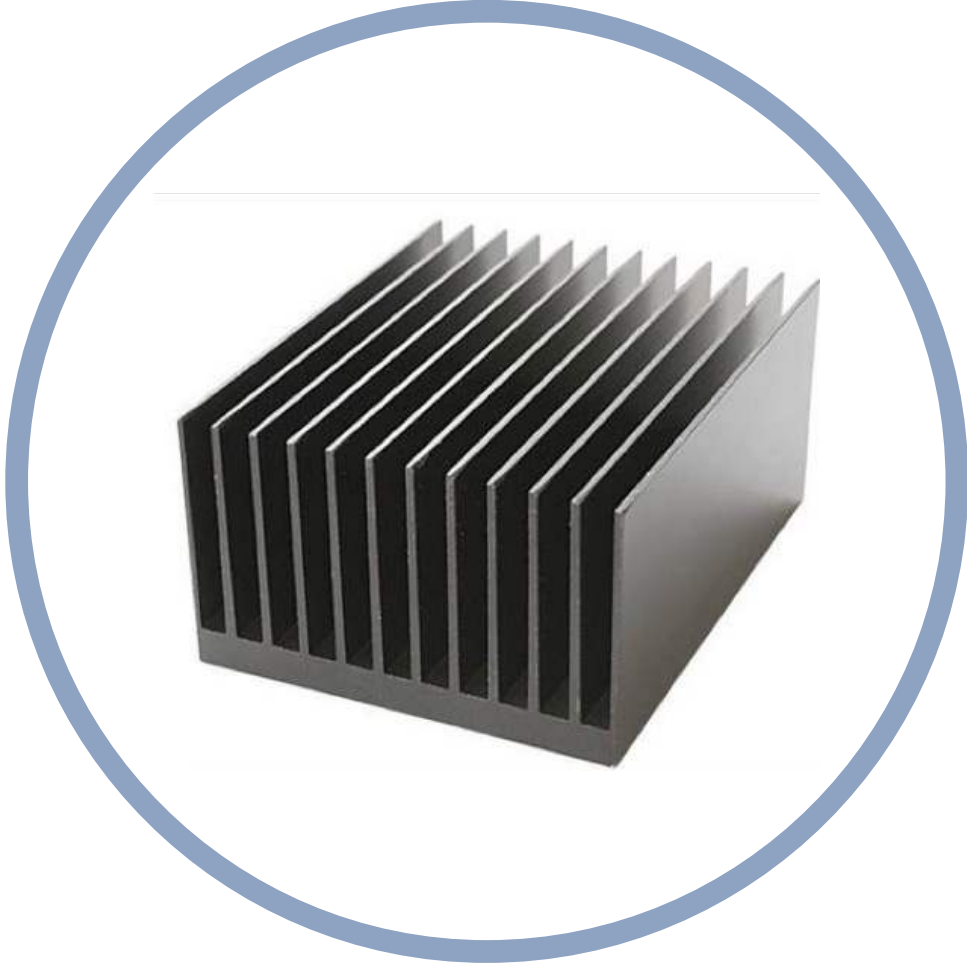

# 12 INCH HIGH ASPECT RATIO THERMAL EXTRUSIONS



## PART NUMBER 122254

**Material:** 6063 Aluminum  
**Description:** 12 Inch Cut Length of Extrusion Profile 19671  
 Cut, Deburred, Washed  
 No Finish

Part Number	Description	Inches				
		Length	Width	Height	Avg Base Thk	Avg Fin Thk
122254	19671 Profile Cut to 12 inches	12	5.324	1.63	0.625	0.096

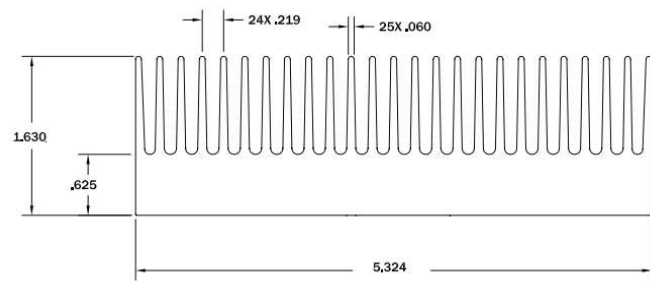

THERMAL RESISTANCE FOR 3", 6", 9" CUT LENGTHS

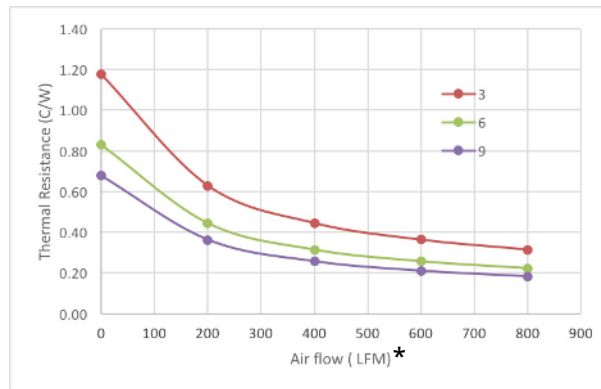

## PART NUMBER 122255



**Material:** 6063 Aluminum  
**Description:** 12 Inch Cut Length of Extrusion Profile 13694  
 Cut, Deburred, Washed  
 No Finish

Part Number	Description	Inches				
		Length	Width	Height	Avg Base Thk	Avg Fin Thk
122255	13694 Profile Cut to 12 inches	12	6.96	2.79	.05	0.1

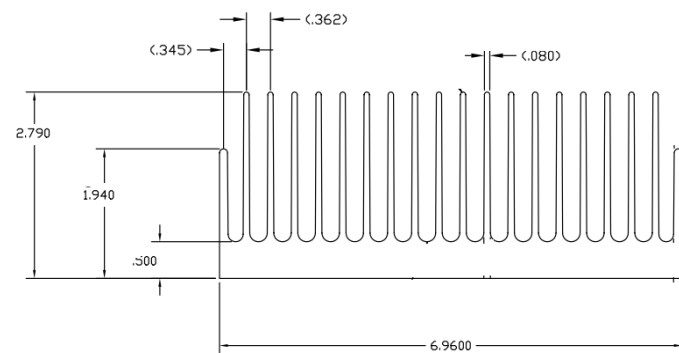

THERMAL RESISTANCE FOR 3", 6", 9" CUT LENGTHS

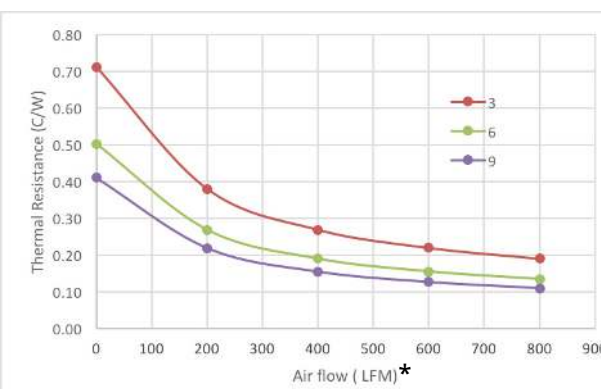

\*Thermal performance data is for reference only and may vary by application  
 \*0 LFM represents a natural convection environment with a vertical heat sink  
 \*All data is based on a fully distributed load on the base of the heat sink  
 \*All forced convection data is based on an open duct configuration



## PART NUMBER 122256

**Material:** 6063 Aluminum  
**Description:** 12 Inch Cut Length of Extrusion Profile 15837  
 Cut, Deburred, Washed  
 No Finish

Part Number	Description	Inches				
		Length	Width	Height	Avg Base Thk	Avg Fin Thk
122256	15837 Profile Cut to 12 inches	12	7	2.275	0.525	0.085

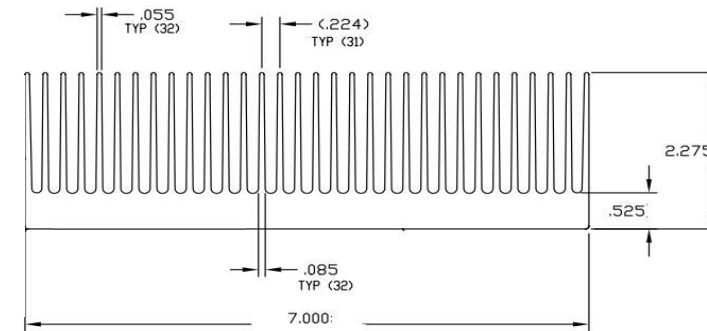

THERMAL RESISTANCE FOR 3", 6", 9" CUT LENGTHS

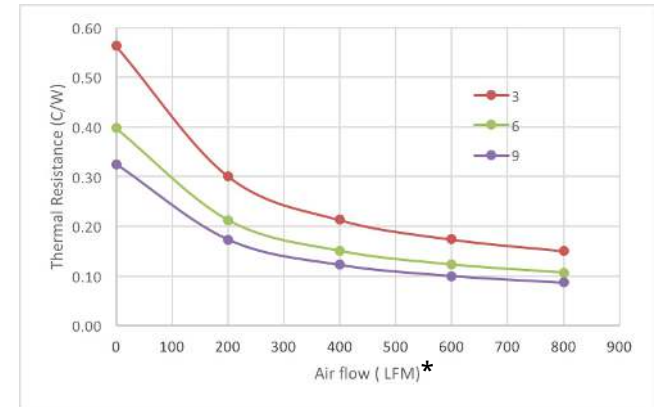

## PART NUMBER 122257

**Material:** 6063 Aluminum  
**Description:** 12 Inch Cut Length of Extrusion Profile 19275  
 Cut, Deburred, Washed  
 No Finish

Part Number	Description	Inches				
		Length	Width	Height	Avg Base Thk	Avg Fin Thk
122257	19275 Profile Cut to 12 inches	12	7.362	2.165	0.292	0.051

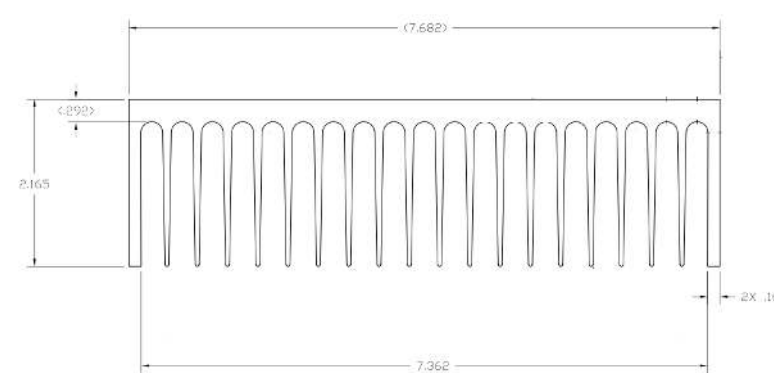

THERMAL RESISTANCE FOR 3", 6", 9" CUT LENGTHS

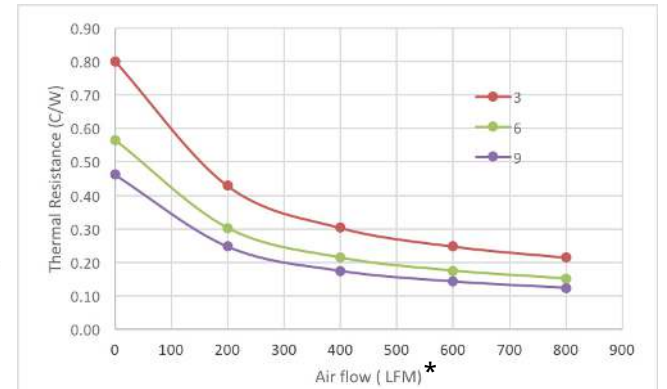

\*Thermal performance data is for reference only and may vary by application  
 \*0 LFM represents a natural convection environment with a vertical heat sink  
 \*All data is based on a fully distributed load on the base of the heat sink  
 \*All forced convection data is based on an open duct configuration

# 12 INCH HIGH ASPECT RATIO THERMAL EXTRUSIONS



## PART NUMBER 122258

**Material:** 6063 Aluminum  
**Description:** 12 Inch Cut Length of Extrusion Profile 15817  
 Cut, Deburred, Washed  
 No Finish

Part Number	Description	Length	Inches			
			Width	Height	Avg Base Thk	Avg Fin Thk
122258	15817 Profile Cut to 12 inches	12	7.375	3.13	0.25	0.09

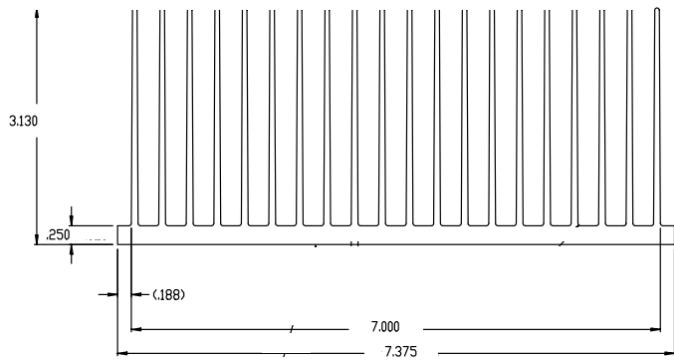

THERMAL RESISTANCE FOR 3", 6", 9" CUT LENGTHS

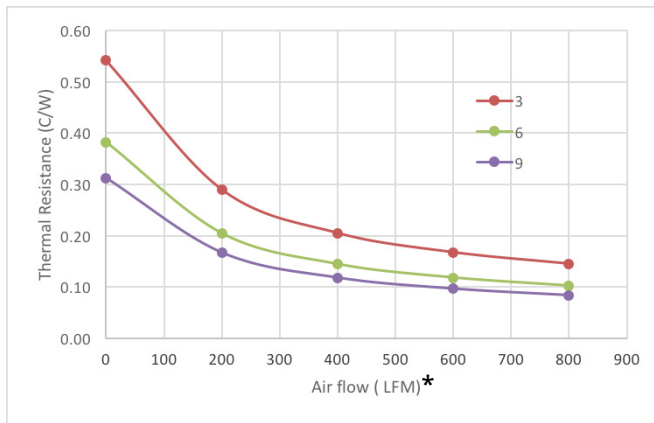

## PART NUMBER 122259



**Material:** 6063 Aluminum  
**Description:** 12 Inch Cut Length of Extrusion Profile 16639  
 Cut, Deburred, Washed  
 No Finish

Part Number	Description	Length	Inches			
			Width	Height	Avg Base Thk	Avg Fin Thk
122259	16639 Profile Cut to 12 inches	12	7.875	1.312	0.312	0.08

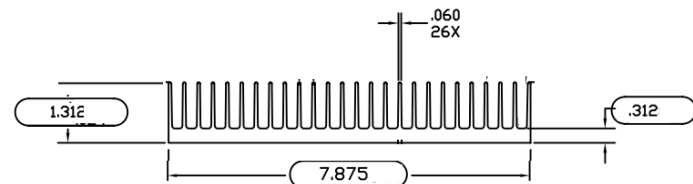

THERMAL RESISTANCE FOR 3", 6", 9" CUT LENGTHS

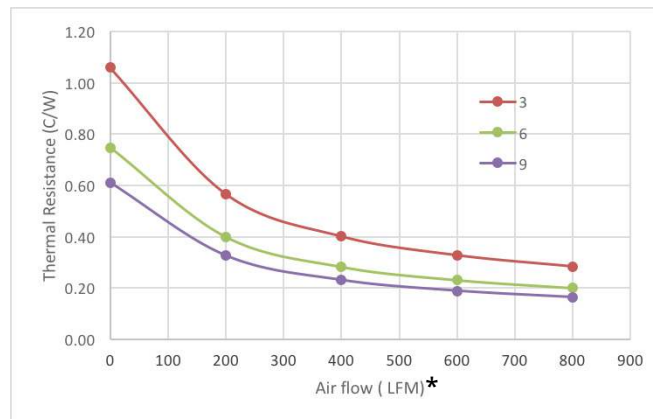

\*Thermal performance data is for reference only and may vary by application  
 \*0 LFM represents a natural convection environment with a vertical heat sink  
 \*All data is based on a fully distributed load on the base of the heat sink  
 \*All forced convection data is based on an open duct configuration



## PART NUMBER 122260

**Material:** 6063 Aluminum  
**Description:** 12 Inch Cut Length of Extrusion Profile 16639  
 Cut, Deburred, Washed  
 No Finish

Part Number	Description	Length	Inches			
			Width	Height	Avg Base Thk	Avg Fin Thk
122260	16639 Profile Cut to 12 inches	12	9.24	2.66	0.125	0.085

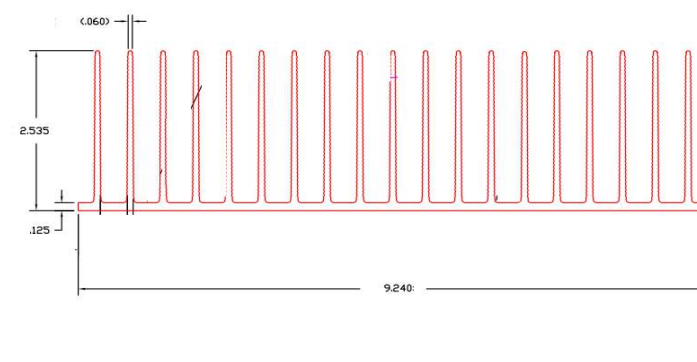

THERMAL RESISTANCE FOR 3", 6", 9" CUT LENGTHS

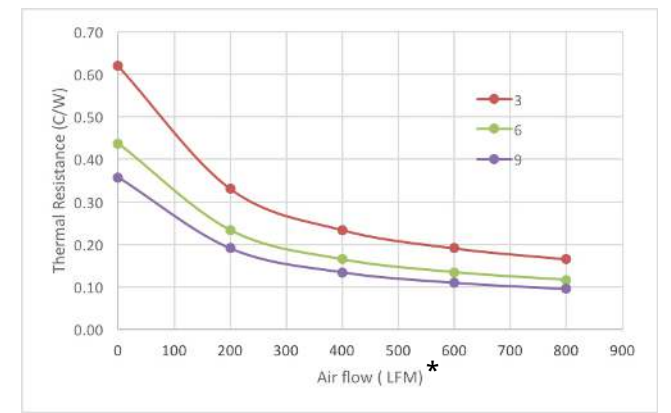

## PART NUMBER 122261

**Material:** 6063 Aluminum  
**Description:** 12 Inch Cut Length of Extrusion Profile 19584  
 Cut, Deburred, Washed  
 No Finish

Part Number	Description	Length	Inches			
			Width	Height	Avg Base Thk	Avg Fin Thk
122261	19584 Profile Cut to 12 inches	12	11	1.375	0.375	0.09

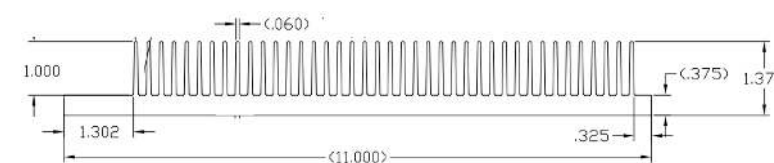

THERMAL RESISTANCE FOR 3", 6", 9" CUT LENGTHS

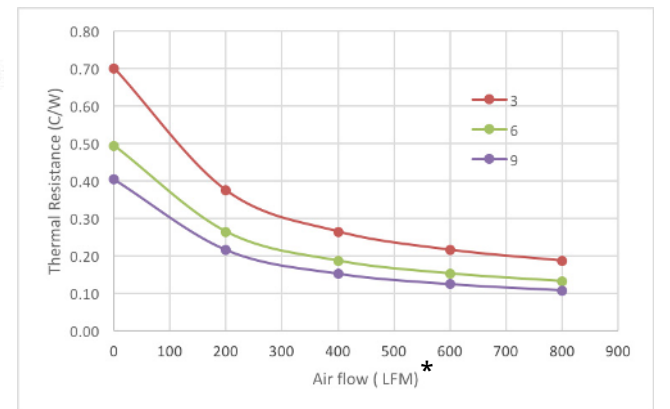

\*Thermal performance data is for reference only and may vary by application  
 \*0 LFM represents a natural convection environment with a vertical heat sink  
 \*All data is based on a fully distributed load on the base of the heat sink  
 \*All forced convection data is based on an open duct configuration



## 12 INCH HIGH ASPECT RATIO THERMAL EXTRUSIONS



### PART NUMBER 122262

**Material:** 6063 Aluminum  
**Description:** 12 Inch Cut Length of Extrusion Profile 19152  
 Cut, Deburred, Washed  
 No Finish

Part Number	Description	Inches				
		Length	Width	Height	Avg Base Thk	Avg Fin Thk
122262	19152 Profile Cut to 12 inches	12	12.25	1	0.25	0.146

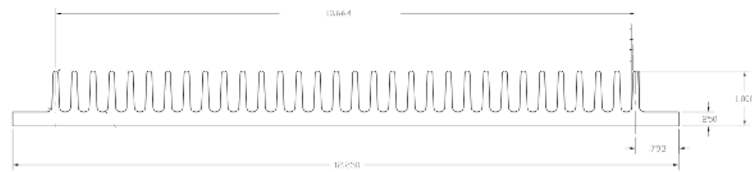

THERMAL RESISTANCE FOR 3", 6", 9" CUT LENGTHS

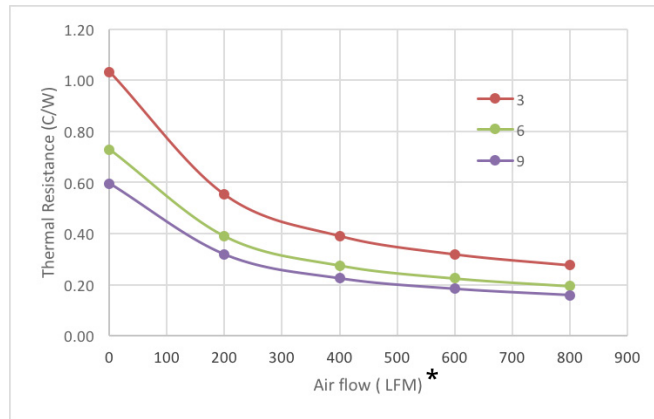

### PART NUMBER 122263



**Material:** 6063 Aluminum  
**Description:** 12 Inch Cut Length of Extrusion Profile 16681  
 Cut, Deburred, Washed  
 No Finish

Part Number	Description	Inches				
		Length	Width	Height	Avg Base Thk	Avg Fin Thk
122263	16681 Profile Cut to 12 inches	12	8.4	1.4	0.4	0.5

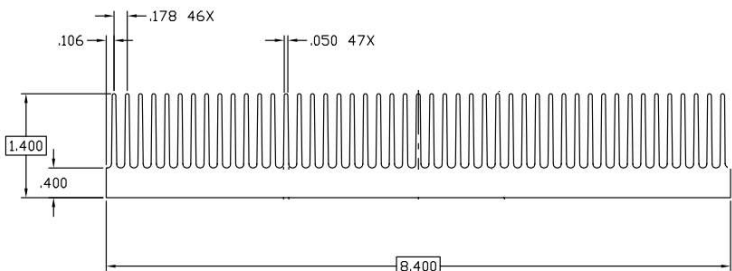

THERMAL RESISTANCE FOR 3", 6", 9" CUT LENGTHS

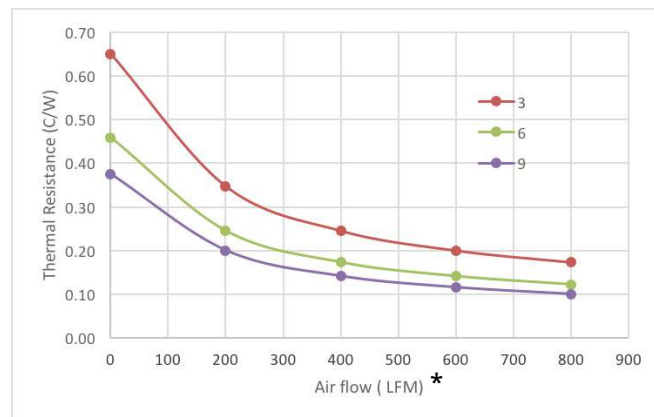

\*Thermal performance data is for reference only and may vary by application  
 \*0 LFM represents a natural convection environment with a vertical heat sink  
 \*All data is based on a fully distributed load on the base of the heat sink  
 \*All forced convection data is based on an open duct configuration



### PART NUMBER 122264

**Material:** 6063 Aluminum  
**Description:** 12 Inch Cut Length of Extrusion Profile 19832  
 Cut, Deburred, Washed  
 No Finish

Part Number	Description	Inches				
		Length	Width	Height	Avg Base Thk	Avg Fin Thk
122264	19832 Profile Cut to 12 inches	12	7.55	2.8	0.5	0.57

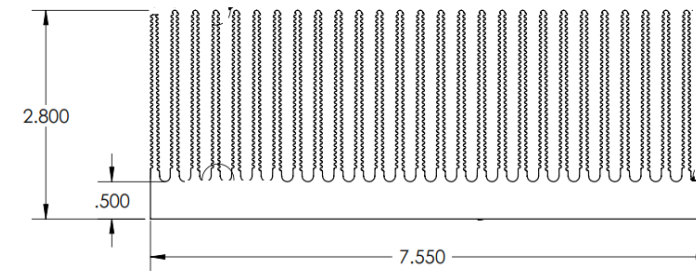

THERMAL RESISTANCE FOR 3", 6", 9" CUT LENGTHS

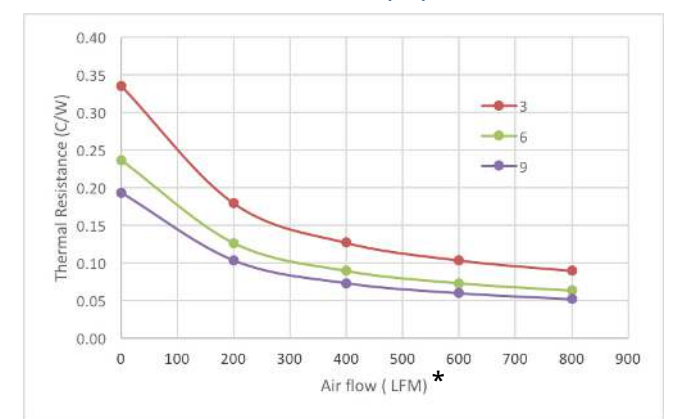

\*Thermal performance data is for reference only and may vary by application  
 \*0 LFM represents a natural convection environment with a vertical heat sink  
 \*All data is based on a fully distributed load on the base of the heat sink  
 \*All forced convection data is based on an open duct configuration

# HIGH ASPECT RATIO THERMAL EXTRUSIONS



## PART NUMBER 122547

Part Number	Description	Inches						Perimeter	Weight Per Piece	Natural Convection (3 in.)
		Length	Width	Height	Avg Base Thk	Avg Fin Thk				
122547	High Aspect Heat Sink for Power Module	15.25	3.98	1.88	0.39	0.123	145	5.5	0.48	

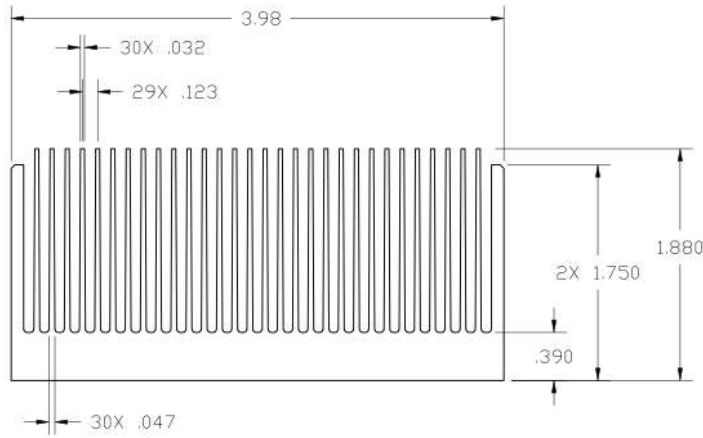

**THERMAL RESISTANCE**  
Natural Convection (°C/W)

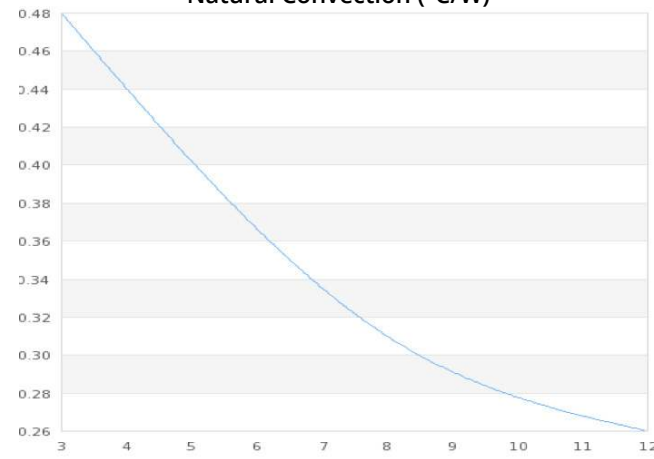

## PART NUMBER 122551



Part Number	Description	Inches						Perimeter	Weight Per Piece	Natural Convection (3 in.)
		Length	Width	Height	Avg Base Thk	Avg Fin Thk				
122551	High Aspect Heat Sink for Power Module	12.32	3.42	1.63	0.25	0.031	73.61	2.61	0.95	

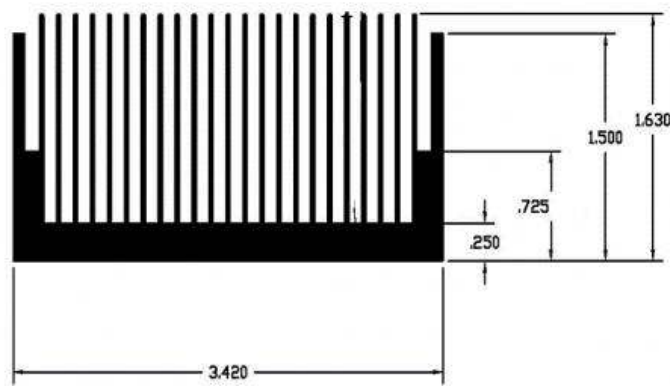

**THERMAL RESISTANCE**  
Natural Convection (°C/W)

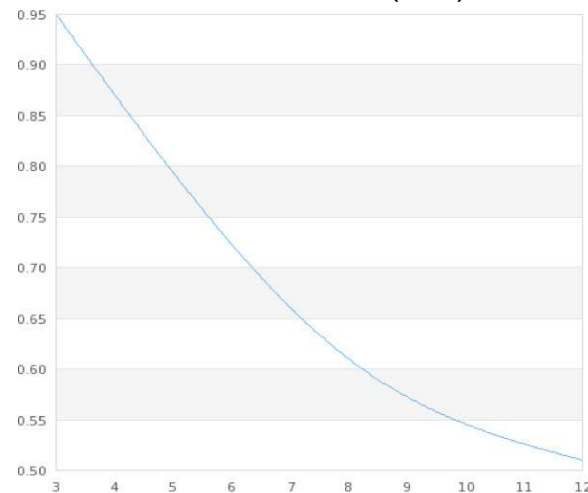

\*Thermal performance data is for reference only and may vary by application  
 \*0 LFM represents a natural convection environment with a vertical heat sink  
 \*All data is based on a fully distributed load on the base of the heat sink  
 \*All forced convection data is based on an open duct configuration



Part No.	Page
PART #	PAGE
103	95
107	95
155	143
258	67
8119	102
8121	102
8542	102
8545	102
8546	102
8556	102
8671	102
8707	102
8709	102
8711	102
8712	102
8714	102
8715	102
8731	102
8732	102
8733	102
8734	102
8735	102
8737	102
8823	102
110578	139
110579	139
110580	139
110581	139
110582	139
110583	139
110584	139
110585	139
120229	139
120231	139
120455	118
120456	118
120457	118
120458	118
120459	118
120460	118
120959	120
120960	120
120961	120
120962	120
120963	120
120964	120
121686	131
121687	131
121688	131
121689	131
121690	131
121691	131
121692	131
121716	131
121717	131
121718	131
121719	131
121720	131
121721	131
121722	131
121723	131
121724	131
121725	131
121726	131
121727	131
121728	131
121729	131

Part No.	Page
121968	131
122254	280
122255	280
122256	281
122257	281
122258	282
122259	282
122260	283
122261	283
122262	284
122263	284
122264	285
122547	286
122551	286
120-2	140
120-320	140
120-5	140
120-8	140
120-80	140
120-SA	140
122-10CC	140
122-2	140
122-30CC	140
126-2	149
126-4	149
126-4S	149
126-5LB	149
130-1	109
130-2	109
130-3	109
130-4	109
130-5	109
130-A	108
130-B	108
130-C	108
130-D	108
130-E	108
130-F	108
130-G	108
130-H	108
130-I	108
130-J	108
130-K	108
130-L	108
130-M	108
130-N	108
130-P	108
132-10B	112
132-10G	112
132-11-B9	112
132-11-G9	112
132-15.5B	112
132-15.5G	112
132-4.5B	112
132-4.5G	112
132-5-B9	112
132-5-G9	112
133-10B	112
133-10G	112
133-11-B9	112
133-11G9	112
133-4.5B	112
133-4.5G	112
133-5-B9	112
133-5-G9	112
133-7.5B	112
133-7.5-B9	112
133-7.5G	112

Part No.	Page
133-7.5G9	112
139-1	109
139-2	109
139-3	109
139-3A	109
139-3B	109
139-3C	109
139-3D	109
139-3E	109
139-3F	109
139-3G	109
139-3H	109
139-3J	109
139-3K	109
139-3L	109
139-3M	109
139-3N	109
139-3P	109
139-5	109
139-5A	109
139-5B	109
139-5C	109
139-5D	109
139-5E	109
139-5F	109
139-5G	109
139-5H	109
139-5J	109
139-5K	109
139-5L	109
139-5M	109
139-5N	109
139-5P	109
143-2	110
143-A	110
143-B	110
143-C	110
143-D	110
143-E	110
143-F	110
143-G	110
143-H	110
143-J	110
143-K	110
143-L	110
144-2	111
144-A	111
144-B	111
144-C	111
144-D	111
144-E	111
145-2	111
145-A	111
145-B	111
145-C	111
145-D	111
145-E	111
145-F	111
146-2	112
146-A	112
146-B	112
146-C	112
146-D	112
146-E	112
146-F	112
146-G	112
152-1A	141
152-1B	141

Part No.	Page
152-KA	141
152-Q	141
153-Q	142
154-Q	143
156-K	144
173-7-220P	145
173-7-230P	145
173-7-240A	145
173-7-240P	145
173-9-1212P	145
173-9-210P	145
173-9-230P	145
173-9-240P	145
173-9-220P	145
174-9-1212P	145
174-9-310P	145
175-6-210P	145
175-6-220P	145
175-6-230P	145
175-6-240P	145
175-6-250P	145
175-6-280P	145
175-6-310P	145
175-6-320P	145
175-6-330P	145
175-6-410P	145
175-6-610P	145
180-10-12C	116
180-10-24C	116
180-10-6C	116
180-11-12C	116
180-11-24C	116
180-11-6C	116
180-12-12C	117
180-12-24C	117
180-12-6C	117
180-20-6C	117
206-1PABEH	50
217-36CTE6	46
217-36CTRE6	46
217-36CTTE6	46
218-40CTE3	47
218-40CTE5	47
219-263A	48
219-263A-TR	49
230-75AB	51
230-75ABE-01	51
230-75ABE-05	51
230-75ABE-10	51
231-137PAB	52
231-137PABE	52
231-137PABE-XXX	52
231-69PAB	52
231-69PABE	52
231-69PABE-XXX	52
231-75PAB	52
231-75PABE	52
231-75PABE-XXX	52
232-200AB	58
232-200ABE-23	58
233-60AB	52
233-60ABE-01	52
233-60ABE-05	52
233-60ABE-10	52
234-75AB	51
234-75ABE-01	51
234-75ABE-05	51
235-85AB	53

Part No.	Page
235-85ABE-01	53
235-85ABE-05	53
235-85ABE-10	53
236-150AB	52
236-150ABE-01	52
236-150ABE-05	52
236-150ABE-10	52
237-167AB2	65
237-167AB3	65
237-167ABE2-24	65
238-200AB	58
238-200ABE-23	58
239-75AB	54
239-75ABE-03	54
239-75ABE-04	54
240-118ABEH-22	57
240-118-ABES-22	57
241-69ABE-03	50
242-125ABE-22	57
243-1PAB	54
243-3PAB	54
244-145AB	59
244-145ABE-50	59
245-145AB	59
245-145ABE-50	59
246-197AB	60
246-197ABE-50	60
247-195-AB	60
247-195-ABE-50	60
248-162AB	61
248-162ABE-50	61
249-113AB	61
249-113ABE-50	61
250-122AB	64
250-122ABE-09	64
250-122ABE-25	64
251-62AB	58
251-80AB	58
251-80ABE-19	58
252-167AB2	65
252-167AB3	65
252-167ABE2-24	65
258	69
260-4T5E	68
260-4TH5E	68
260-65H5E	68
262-75ABE-01	51
262-75ABE-05	51
265-118ABHE-22	55
270-AB	63
271-AB	62-63
272-AB	63
273-AB	56
273-ABE-01	56
273-ABE-02	56
274-1AB	56
274-1ABE-01	56
274-1ABE-02	56
274-2AB	56
274-2ABE-01	56
274-2ABE-02	56
274-3AB	56
274-3ABE-01	56
274-3ABE-02	56
275-75AB	52
275-75ABE-01	52
275-75ABE-10	52
280-AB	63

Part No.	Page
281-1AB	56
281-2AB	56
285 SC	67
286-AB	66
286-CBTE	66
286-CTE	66
286DBE	55
287-1ABE	66
287-2ABE	66
288-1ABE	62
289-AB	64
289-AP	64
290-1AB	64
290-2AB	64
291-C236AB	65
291-H36AB	65
292-AB	70
301K	88
301M	88
301N	88
302M	88
302MM	88
302N	88
302NN	88
303M	88
303MM	88
303N	88
303NN	88
330 SC	67
392-120AB	101
392-120AG	101
392-180AB	101
392-180AG	101
392-300AB	101
392-300AG	101
394-1AB	93
394-2AB	93
395-1AB	93
395-2AB	93
396-1AB	93
396-2AB	93
401A	89
401F	89
401K	89
403A	89
403F	89
403K	89
413A	90
413F	90
413K	90
418B	159
419C	159
421A	90
421F	90
421K	92
422B	159
422C	159
422C7	159
422D	160
423A	90
423K	90
426B	159
426C	159
426C7	159
426D	160
431K	90
433K	90
435AAAA	91

Part No.	Page
438C	159
441K	89
465K	92
476K	92
476W	92
486K	91
489K	91
490-12K	92
490-35K	92
490-6K	92
510-U	100
510-M	100
510-12M	100
510-12U	100
510-14M	100
510-14U	100
510-3M	100
510-3U	100
510-6M	100
510-6U	100
510-9M	100
510-9U	100
511-U	100
511-M	100
511-12M	100
511-12U	100
511-3M	100
511-3U	100
511-6M	100
511-6U	100
511-9M	100
511-9U	100
512-U	100
512-M	100
512-12M	100
512-12U	100
512-3M	100
512-3U	100
512-6M	100
512-6U	100
512-9M	100
512-9U	100
517-95AB	97
518-95AB	97
527-24AB	97
527-45AB	97
528-24AB	97
528-45AB	97
537-24AB	96
537-45AB	96
537-95AB	96
547-24AB	96
547-45AB	96
547-95AB	96
557-140AB	94
558-75AB	94
559-50AB	94
569-100AK	28
579-150AK	28
589-150AK	28
599X-100AB	28
601E	75
601F	75
601K	75
602-100AP	20
603K	75
604-40AB	20
604-60AB	20

Part No.	Page
605-75AB	21
606-77AB	21
607-65AB	22
609-100AB	19
609-50AB	19
610-35AB	22
610-40AB	

# EXTRUDED ALUMINUM HEAT SINK PROFILES

Wakefield Engineering offers a wide variety of standard profiles. If an extrusion profile that meets your needs is not offered, consult the factory for additional profiles as they become available, alternatives or custom solutions. Six foot lengths are standard; however, other lengths are available.

## PROFILE NUMERICAL INDEX DIRECTORY

Extrusion/ Heat Sink	Pg. No.	Row Loc.
<b>FLATBACK</b>		
10178	232	D
12382	221	C
12424	185	D
12405	213	D
12407	194	A
12447	213	B
12487	195	A
12540	194	A
12714	222	C
13068	227	C
13457	202	D
13505	216	B
14135	176	B
14187	178	B
14407	219	C
14419	228	C
14738	172	D
15037	218	D
15672	186	A
16335	223	C
16373	224	B
16486	227	D
16499	201	D
16758	230	A
16839	183	D
16919	214	D
17032	214	D
17047	206	C
17049	205	B
17080	210	A
17096	231	D
17118	232	A
19035	229	C
19036	218	A
19052	227	A
19081	235	A
19082	235	A
19113	225	B
19155	218	C
19197	200	D
19249	209	D
19273	225	D
19275	226	D
19260	216	A
19333	223	C
19341	220	A
19343	219	B
19350	218	B
19353	207	C
19403	233	B
19407	184	C
19409	210	D
19457	205	D
19492	203	C
19493	224	B
19529	206	A
19535	226	B
19536	225	A
19539	214	A

Extrusion/ Heat Sink	Pg. No.	Row Loc.
19572	232	B
19584	232	D
19596	223	A
19608	232	C
19671	217	B
19679	222	C
19694	207	D
19700	226	D
19707	227	B
PH18403	227	B
19721	226	B
19740	233	B
19768	215	C
19772	229	B
19787	210	C
19791	229	C
19803	194	D
19810	217	D
19832	226	C
19839	228	B
19843	203	D
19864	220	A
19902	227	C
21052	230	D
21081	222	D
21105	212	C
21107	221	C
21117	207	D
21139	212	D
21153	213	A
21257	219	C
21265	230	C
21295	205	A
21408	226	A
21848	221	B
21884	189	C
82266	233	A
002853	206	B
002981	219	C
003385	221	C
003413	183	B
003676	221	B
003942	185	C
004506	187	B
005329	179	A
005355	197	C
005473	197	A
006369	224	C
006513	173	B
006606	179	C
006663	224	D
006664	221	D
006872	215	B
007264	216	C
007541	197	A
007657	221	C
008469	215	B
008563	214	C
008658	208	A
008702	186	C

Extrusion/ Heat Sink	Pg. No.	Row Loc.
008842	181	C
009099	199	C
009168	208	D
009239	189	C
009396	208	B
009797	204	A
010248	218	D
010313	180	A
010785	208	B
010818	196	A
010979	175	D
010980	187	D
010998	210	C
011005	213	C
011077	204	D
011173	174	B
011175	198	A
011238	201	D
011296	175	D
011299	208	A
011381	178	A
011422	199	B
011423	199	B
011424	178	A
011425	220	D
011447	190	C
011448	186	B
011457	203	A
011465	186	D
011485	177	D
011492	183	B
011498	183	B
011738	192	B
011740	188	C
011741	185	B
011743	219	D
011758	204	D
011820	192	A
011838	199	D
011880	191	B
011890	194	C
011891	193	D
011927	180	D
011939	173	D
011940	174	A
011942	213	D
011944	211	D
011975	200	B
012021	196	C
012054	220	B
012061	214	A
012062	181	B
012096	201	A
012098	215	D
012103	189	B
012106	187	D
012108	204	B
012110	185	C
012116	223	B

Extrusion/ Heat Sink	Pg. No.	Row Loc.
012148	181	C
012165	193	C
012166	205	D
012174	193	B
012182	188	B
012226	200	A
012228	182	A
012234	173	D
012235	172	B
012242	188	C
012246	186	A
012331	216	C
012334	185	D
012388	183	D
012395	225	B
012396	205	B
012397	210	A
012401	193	D
012406	193	C
012414	225	A
012416	184	D
012423	204	C
012443	203	B
012464	219	D
012489	193	A
012504	226	B
012517	173	C
012518	202	A
012575	215	A
012580	184	D
012584	183	C
012613	194	B
012614	212	B
012646	181	B
012661	194	C
012671	218	C
012677	209	A
012680	202	B
012693	221	A
012696	207	D
012704	181	C
012712	188	B
012749	210	B
012777	212	B
012823	212	A
012843	226	C
012879	193	D
012894	211	A
012904	174	A
012914	199	A
012918	212	C
012932	205	C
012947	200	B
012987	211	C
012988	198	B
012989	199	A
012990	182	A
013000	201	B
013017	190	D
013068	227	C

Extrusion/ Heat Sink	Pg. No.	Row Loc.
013075	187	C
013096	211	A
013098	192	D
013099	211	A
013100	192	C
013101	192	D
013102	192	C
013141	194	D
013143	205	D
013151	186	B
013156	196	B
013158	183	C
013203	212	D
013205	186	D
013206	186	D
013208	187	A
013210	187	D
013211	190	A
013212	190	A
013213	190	B
013215	199	C
013224	214	B
013237	219	A
013254	172	B
013260	192	C
013266	221	D
013277	220	C
013293	202	B
013295	182	B
013512	220	D
013513	188	D
013521	182	B
013532	218	D
013542	204	C
013564	209	D
013568	175	D
013569	206	C
013570	216	D
013583	214	D
013597	225	C
013599	179	D
013601	219	B
013605	207	A
013607	175	C
013618	212	A
013621	222	B
013636	200	A
013647	189	A
013659	222	D
013664	213	B
013670	190	B
013673	176	B
013677	225	D
013685	199	C
013716	212	A
013717	212	B
013719	196	C
013721	199	A
013729	209	B
013733	208	C
013750	196	D
013756	210	D
013757	229	D
013772	234	C
013796	220	A
013849	230	C
013929	225	B
013953	230	D
014085	227	B

Extrusion/ Heat Sink	Pg. No.	Row Loc.
014113	225	D
014235	189	A
014236	231	B
014240	174	B
014243	196	B
014249	189	C
014262	202	A
014269	195	B
014284	204	B
014291	196	B
014306	224	C
014320	213	A
014326	195	A
014338	176	D
014359	178	D
014360	191	C
014361	178	B
014362	191	D
014363	178	B
014364	192	B
014367	203	B
014373	194	B
014374	185	C
014401	224	D
014418	191	A
014427	194	B
014432	187	D
014462	219	B
014468	226	A
014476	188	A
014701	194	D
014702	196	C
014727	187	B
014746	222	D
014757	224	C
014762	195	D
014769	179	A
014770	211	D
014771	191	C
014772	190	C
014793	209	A
014801	203	A
014802	189	B
014803	203	A
014813	208	C
014815	182	C
014819	190	D
014837	183	D
014844	202	D
014850	184	C
014853	201	B
014854	190	C
014883	179	C
014960	194	C
014964	194	A
014965	212	D
014966	202	C
014970	185	D
014984	216	C
014987	176	A
015019	204	D
015045	203	C
015138	213	A
015145	200	D
015163	184	C
015172	209	C
015174	210	C
015184	182	C
015189	228	B

Extrusion/ Heat Sink	Pg. No.	Row Loc.
015231	215	B
015240	200	D
015273	207	C
015604	193	B
015611	229	A
015633	223	D
015672	186	A
015712	211	B
015745	224	A
015768	178	C
015769	223	B
015774	230	C
015785	198	D
015786	190	A
015837	224	B
015840	217	C
015854	229	C
015862	221	D
0158		



Extrusion/ Heat Sink	Pg. No.	Row Loc.
014270	239	B
014714	244	B
015018	244	A
015935	242	D
015956	244	A
016036	240	B
016145	239	C
016313	244	D
016314	243	D
016345	244	D
016372	243	D
016465	240	C
016582	242	B
XX0236	242	A
XX1007	238	D
XX1020	241	A
XX10222	238	D
XX1026	243	C
XX1055	242	C
XX1063	239	A
XX1073	244	C
XX1076	244	A
XX1077	244	C
XX1111	240	A
XX1284	239	B
XX1327	243	B
XX1351	241	C
XX1353	239	D
XX1354	239	A
XX1371	242	D
XX1409	239	C
XX1452	240	B
XX1453	239	B
XX1459	242	D
XX1502	243	C
XX1546	239	D
XX1551	241	C
XX1552	240	C
XX1881	241	D
XX2058	245	A
XX2558	238	C
XX4306	240	D
XX4319	240	D
XX4425	240	A
XX4502	241	A
XX4562	242	A
XX4563	241	D
XX4618	243	A
XX4670	243	B
XX4671	243	C
XX4721	238	D
XX4753	241	B
XX4865	239	C
XX4920	240	C
XX5036	241	B
XX5052	242	B
XX5057	241	C
XX5061	242	B
XX5166	241	B
XX6520	242	A
XX6980	243	A
XX7013	241	D
XX7019	244	D
XX7045	241	A
XX7051	243	A
XX7057	244	C
XX7070	240	B
XX7134	239	D

Extrusion/ Heat Sink	Pg. No.	Row Loc.
XX7331	243	D
XX8340	242	C
XX8382	240	A
XX9004	242	C
MULTI CHANNEL		
04842	246	B
003230	245	D
003295	245	B
006412	246	D
007999	246	A
009146	245	C
014324	247	A
014967	245	A
016333	247	A
016503	247	C
016529	246	C
016679	245	C
XX1112	246	B
XX3002	247	A
XX3012	246	D
XX3013	246	D
XX3017	246	C
XX3022	246	C
XX3047	245	C
XX3050	245	D
XX4617	246	B
XX4643	245	D
XX4645	245	B
XX4917	246	A
XX5060	247	B
XX5541	247	B
XX5959	245	B
XX7055	247	C
XX7084	245	A
XX8182	247	B
XX9014	246	A
FLATBACK W/ INTERGRAL MOUNTING FEET		
16493	251	C
16494	251	C
16770	249	D
17091	252	A
19404	250	C
19456	248	A
19834	250	D
000806	250	D
002756	249	B
006242	251	A
009238	249	D
013782	251	A
013838	250	B
013994	250	C
014214	249	A
014282	251	B
014285	249	B
014343	247	D
014344	247	D
014428	249	C
014712	248	A
014751	248	A
014820	250	A
014915	250	B
016319	251	D
016922	251	C
019133	247	C
XX1024	249	A
XX1025	249	C

Extrusion/ Heat Sink	Pg. No.	Row Loc.
XX1194	248	B
XX1645	248	D
XX1662	248	C
XX1714	249	D
XX1774	248	B
XX2197	251	B
XX2276	249	B
XX3090	249	C
XX3213	251	D
XX4201	248	B
XX4450	248	C
XX4600	248	D
XX4874	247	D
XX6438-2	251	A
XX7017	248	C
XX7072	249	A
XX7074	248	D
XX7108	251	B
XX7109	250	D
XX7330	250	A
XX7332	250	A
XX8014	251	D
XX8131	250	B
XX8623	250	C
T-STYLE		
12230	254	A
14102	255	D
14378	252	C
14369	253	D
14410	255	D
15299	253	D
16302	255	A
19670	256	A
16834	255	C
19020	255	A
19342	253	D
21103	254	D
21104	255	C
005008	252	B
005651	253	A
006639	252	D
009100	253	A
009170	252	B
009212	254	C
009284	252	A
009319	254	B
009321	253	C
009891	253	A
011300	254	A
012176	252	A
012232	252	B
012678	255	A
012709	252	D
013563	252	D
014265	253	C
014278	255	B
014345	254	B
014763	254	D
015067	253	C
015108	255	C
015295	252	C
015765	254	C
015918	252	C
016178	254	A
016853	253	B
XX4220	254	D
XX4228	253	B
XX4477	255	B

Extrusion/ Heat Sink	Pg. No.	Row Loc.
XX4891	254	B
XX6203	254	C
XX7030	255	B
XX7056	255	D
XX8088	253	B
H-STYLE		
04530	260	C
05106	259	D
08073	256	B
12277	260	A
16340	259	B
17086	261	D
19103	260	D
19429	260	D
002863	258	C
003208	259	C
003539	257	B
003572	257	C
003573	257	C
003663	258	D
003731	260	A
004591	258	B
005024	261	B
005207	261	B
005511	257	D
005821	259	A
005875	256	D
005984	259	C
006064	257	C
006393	257	B
006679	256	D
006748	260	A
006821	261	C
008266	257	B
008889	258	D
008890	259	A
008891	261	A
010088	257	A
010663	260	B
010803	257	B
010839	258	B
010837	259	A
013959	261	A
015671	258	C
XX10202	258	A
XX1157	259	D
XX1244	258	D
XX1245	261	A
XX1251	262	A
XX1273	260	D
XX1541	261	C
XX1637	257	D
XX2131	261	B
XX2726	260	C
XX3057	261	D
XX3547	260	C
XX4005	259	B
XX4051	259	B
XX4101	258	C
XX4226	259	D
XX4511	258	A
XX4666	260	B
XX4701	257	D
XX4850	258	A
XX5167	256	D
XX5183	256	C
XX5195	256	C
XX5313	260	B

Extrusion/ Heat Sink	Pg. No.	Row Loc.
XX6533	256	A
XX6981	261	D
XX6996	257	A
XX7075	256	C
XX7093	258	B
XX7157	259	C
XX8029	256	A
XX8073	256	B
XX8420	256	B
XX9018	261	C
DOUBLE-SIDED		
04551	262	C
05013	262	D
10498	262	B
14056	262	C
14714	262	B
19638	262	B
19363	262	A
21037	262	C
014879	262	D
XX4551	262	D
XX5013	263	A
XX8479	262	A
MOUNTING SHELF		
05040	263	A
14203	264	C
16300	264	B
16350	264	A
16464	265	A
19027	263	A
19856	265	A
008999	263	C
014264	264	A
014313	264	D
XX10323	264	C
XX1753	263	D
XX2159	263	C
XX4336	263	B
XX4478	264	B
XX4760	264	C
XX4878	263	B
XX5568	263	C
XX6112	264	A
XX6183	263	D
XX6201	264	B
XX6211	264	D
XX7009	263	D
XX7037	263	B
XX7046	265	A
XX7089	264	D
PRESS PACK		
05730	265	C
12573	266	D
15779	265	B
15781	266	B
16714	267	C
16900	268	B
16901	268	B
17117	267	D
19472	268	A
19543	265	B
19607	267	C
19613	267	A
19688	267	D
19732	265	B
21415	267	C

Extrusion/ Heat Sink	Pg. No.	Row Loc.
003537	265	D
013450	266	B
014191	265	D
014442	267	B
014779	267	A
016235	267	B
XX10239	267	D
XX3529	266	A
XX3559-2	266	D
XX3560-2	266	B
XX3561-2	266	C
XX3849	265	C
XX4554	266	A
XX5306	265	C
XX5311	266	A
XX5360	268	A
XX5730	265	D
XX5731	266	C
XX5732	266	C
XX5733	267	A
XX5734	267	B
XX5735	268	B
XX5736	266	D
XX6351	268	A
XX7151	268	B
POWER MODULE		
02726	268	D
13444	268	C
14703	269	B
16558	269	C
17111	269	D
013698	268	D
016988	269	A
017003	269	C
XX16104	268	C
XX5315	268	D
XX5655	269	C
XX5714	268	C
XX7091	269	B
XX7092	269	B
XX7300	269	A
XX8110	269	A
FORCED CONVECTION		
14263	270	A
14342	270	B
14499	271	A
14483	271	A
14711	271	B
19473	270	A
19535	271	B
XX1040-P1	269	D
XX1040-P2	270	B
XX1243-P1	271	A
XX1243-P2	270	C
XX1288	270	C
XX1320	270	C
XX1961	269	D
XX2301	270	A
XX6051	270	D
XX6052	270	D
XX6061	270	B
XX6071	270	D
MODULAR		
XX6031	271	C
XX6032	271	B
XX6102	272	B

Extrusion/ Heat Sink	Pg. No.	Row Loc.
XX6110	272	A
XX6111	272	B
XX6115	272	A

**Resin** - A term used for an organic polymer that when mixed with a curing agent crosslinks to form a thermosetting plastic.

**Resistance** - The property of a conductor that opposes the flow of current by dissipating energy as heat. In packages, it causes voltage and current loss in signal and power distribution systems.

**SCR** - Silicon controlled rectifier.

**Shrinkage** - The decrease in volume, or contraction of a material by the escape of any volatile substance, or by a chemical or physical change in the material.

**Single-in-Line (SIP)** - DIP-like package with single line of leads as opposed to two for DIP.

**Solvent Cleaner** - The process of removing soil from a substrate surface with an organic solvent. The solvent cleaning process does not alter the substrate physically or chemically.

**Specific Heat** - The ratio of thermal energy required to raise the temperature of a body 1° to the thermal energy required to raise an equal mass of water 1°.

**Storage Life** - The period of time during which a packaged adhesive can be stored under specific temperature conditions and remain suitable for use. Often called "Shelf Life."

**Surface Mount Technology (SMT)** - A method of assembling hybrid circuits and printed wiring boards, where component parts are mounted onto, rather than into, the printed wiring board, as in the mounting of components on substrates in hybrid technology.

**Tack (Green Strength)** - The property of an adhesive that enables it to form a bond of measurable strength immediately after adhesive and adherend are brought into contact under little or no pressure.

**Tape Automated Bonding (TAB)** - The process where silicon chips are joined to patterned metal or polymer tape using thermocompression bonding, and subsequently attached to a substrate or board by outer lead bonding. Intermediate processing may be carried out in strip form through operations such as testing, encapsulation, bum-in, and excising the individual packages from the tape.

**TCE** - Temperature coefficient of expansion.

**Temperature, Curing** - The temperature at which an adhesive or assembly is subject to curing.

**Temperature Cycling** - An environmental test where the film circuit is subjected to several temperature changes from a low temperature to a high temperature over a period of time.

**Thermal Conductivity** - A measure of a material's ability to conduct heat; physical constant for quantity of heat that passes through unit volume of a substance in unit of time when difference in temperature of two opposite faces is unity.

**Thermal Cycling** - A method to impose cyclical stress on an assembly of microelectronic components by alternately heating and cooling in an oven. It is used for accelerated reliability testing of assemblies.

**Thermal Expansion** - An increase in size due to an increase in temperature expressed in units of an increase in length or increase in size per degree.

**Thermal Gradient** - The plot of temperature variances across the bulk thickness of a material being heated.

**Thermal Mismatch** - Difference in thermal coefficients of expansion of materials which are bonded together.

**Thermal Resistance (°C/W)** - The opposition offered by a medium to the passage through it of thermal energy.

**Thermocouple** - The junction of two dissimilar metals which has a voltage output proportional to the difference in temperature between the hot junction and the lead wires.

**Thermoset** - Material that will undergo or has undergone a chemical reaction by the action of heat, catalyst, ultraviolet light, etc., leading to a relatively infusible state.

**Transistor Outline (TO)** - Industry standard package designation established by JEDEC of the EIA.

**Trim Die** - Die for shearing or shaving flash from a casting. Either the die is forced over the casting, or the casting is forced through the die.

**Viscosity** - A measure of the resistance of a fluid to flow or the internal friction within the body or fluid.

**Working Life** - The period of time during which a liquid resin or adhesive, after mixing with a catalyst, solvent, or other compounding ingredients, remains usable. Also known as "Pot Life".

**Zero-insertion-Force Connection (ZIF)** - A form of connector that allows the connector pins to be brought together under very low force, then wiped and pressed together during cam activation. Low insertion force is LIF.