



High Performance ASIC Cooling Solutions w/Thermal Tape Attachment

ATS PART # ATS-56013-C3-R0

Features & Benefits

- » maxiFLOW™ design features a low profile, spread fin array that maximizes surface area for more effective convection (air) cooling
- » Designed specifically for ASIC package and their unique cooling requirements
- » Comes preassembled with high performance thermal interface material

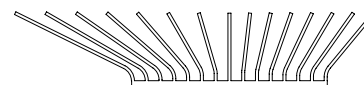
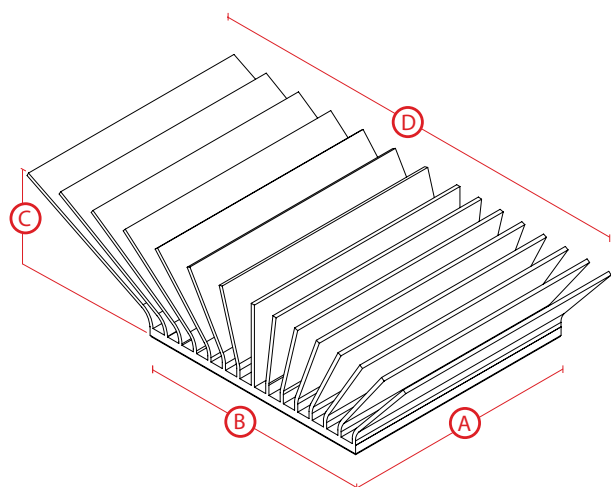

**Image above is for illustration purposes only.*

Thermal Performance

AIR VELOCITY

THERMAL RESISTANCE

FT/MIN	M/S	°C/W (UNDUCTED FLOW)	°C/W (DUCTED FLOW)
200	1.0	2.2	1.2
300	1.5	1.8	
400	2.0	1.4	
500	2.5	1.2	
600	3.0	1.1	
700	3.5	0.96	
800	4.0	0.87	

Product Details

DIMENSION A	DIMENSION B	DIMENSION C	DIMENSION D	INTERFACE MATERIAL	FINISH
42 mm	42 mm	16 mm	77 mm	SAINT-GOBAIN C675	GOLD-ANODIZED

NOTES:

- 1) Dimension C = heat sink height from bottom of the base to the top of the fin field.
- 2) Thermal performance data are provided for reference only. Actual performance may vary by application.
- 3) ATS reserves the right to update or change its products without notice to improve the design or performance.
- 4) Contact ATS to learn about custom options available.



ATS ADVANCED THERMAL SOLUTIONS, INC.
Innovations in Thermal Management®

For more information, to find a distributor or to place an order, visit www.qats.com or call: 781.769.2800 (North America); +31 (0) 3569 84715 (Europe).