



Comair Rotron Specification Sheet

Specification Date: Feb 01, 2018

Version: 01

COMAIR ROTRON PART NUMBER: 17000658A
COMAIR ROTRON MODEL NUMBER: CREC2258-3600E2B

A.) MOTOR:

RATED VOLTAGE:	230VAC \pm 10%
OPERATING VOLTAGE RANGE:	207~253VAC
LOW-START VOLTAGE:	172VAC
RATED CURRENT:	0.58 Amps
OPERATING FREQUENCY:	50~60Hz
INPUT POWER:	90 Watts
RATED SPEED:	3600 RPM \pm 5% (At Free Delivery)
MOTOR TYPE:	Brushless EC
MOTOR PROTECTION:	By Integrated Circuit
LOCKED ROTORT PROTECTION:	IC protected
POLARITY PROTECTION:	Yes
AUTOMATIC RESTART CAPABILITY:	By Integrated Circuit
ROTATION:	Counter Clockwise when viewed from the impeller

B.) MECHANICAL

DIMENSIONS:	225mm x225mm x 80mm
WEIGHT:	1800g
BEARING TYPE:	Ball Bearings
VENTURI:	Die Cast magnesium alloy, ED coating and powder coating
PROPELLER:	Die Cast magnesium alloy, ED coating and powder coating



Comair Rotron Specification Sheet

Specification Date: Feb 01, 2018

Version: 01

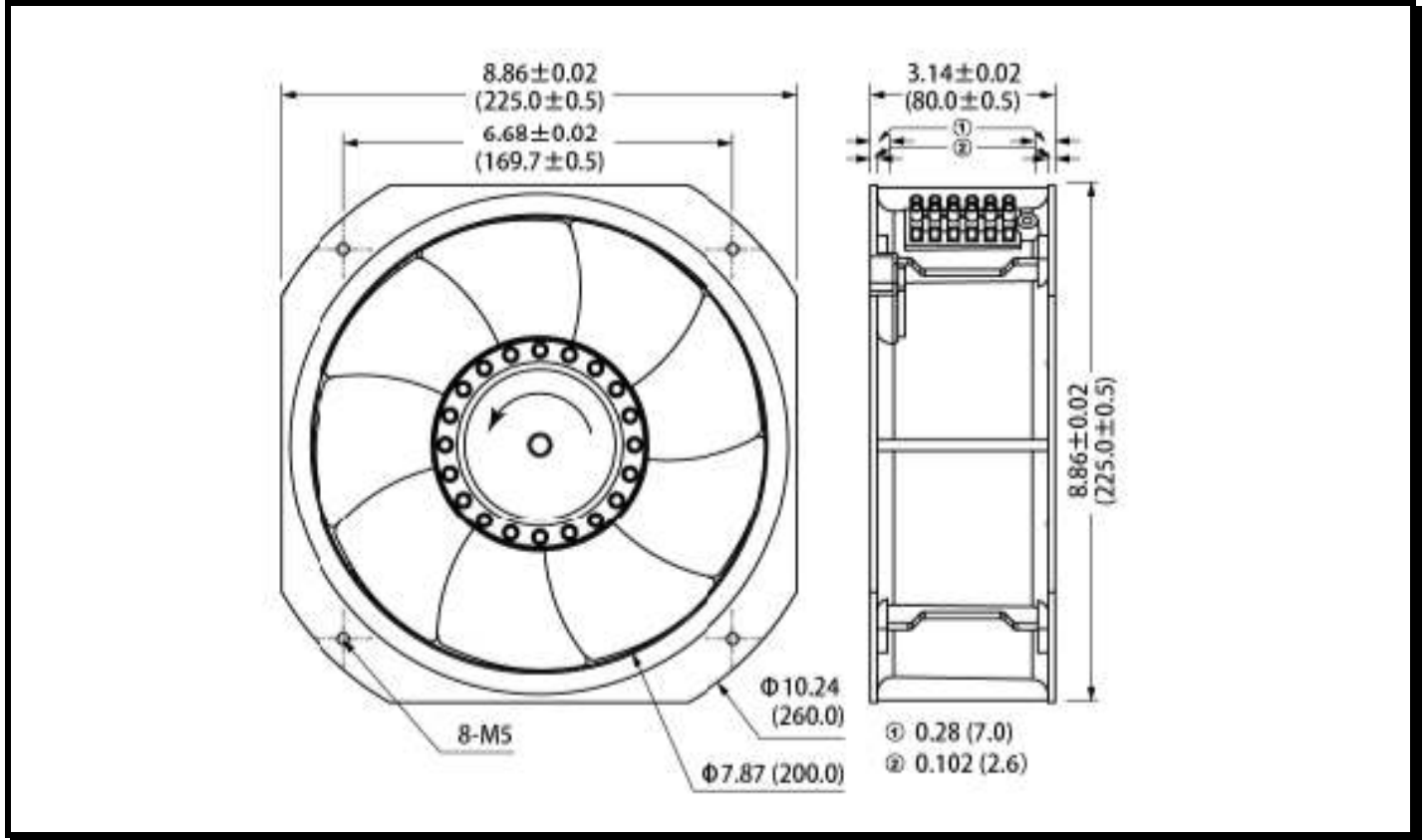

Figure 1

C.) ENVIRONMENTAL

OPERATING TEMPERATURE:

-20°C to +70°C

STORAGE TEMPERATURE:

The storage temperature will be suggested at -20°C ~ 50°C to ensure a better performance.

HUMIDITY:

20 to 85% RH, non-condensing



Comair Rotron Specification Sheet

Specification Date: Feb 01, 2018

Version: 01

D.) PERFORMANCE CHARACTERISTICS

AIR FLOW:	685 CFM \pm 5% (Measuring at zero static pressure)
STATIC PRESSURE:	1.29" Inches of H2O (Measuring at zero airflow)
ACOUSTIC LEVEL:	71 dBA Max. at MAX. speed (Measured via Freely Suspended at 1 meter)

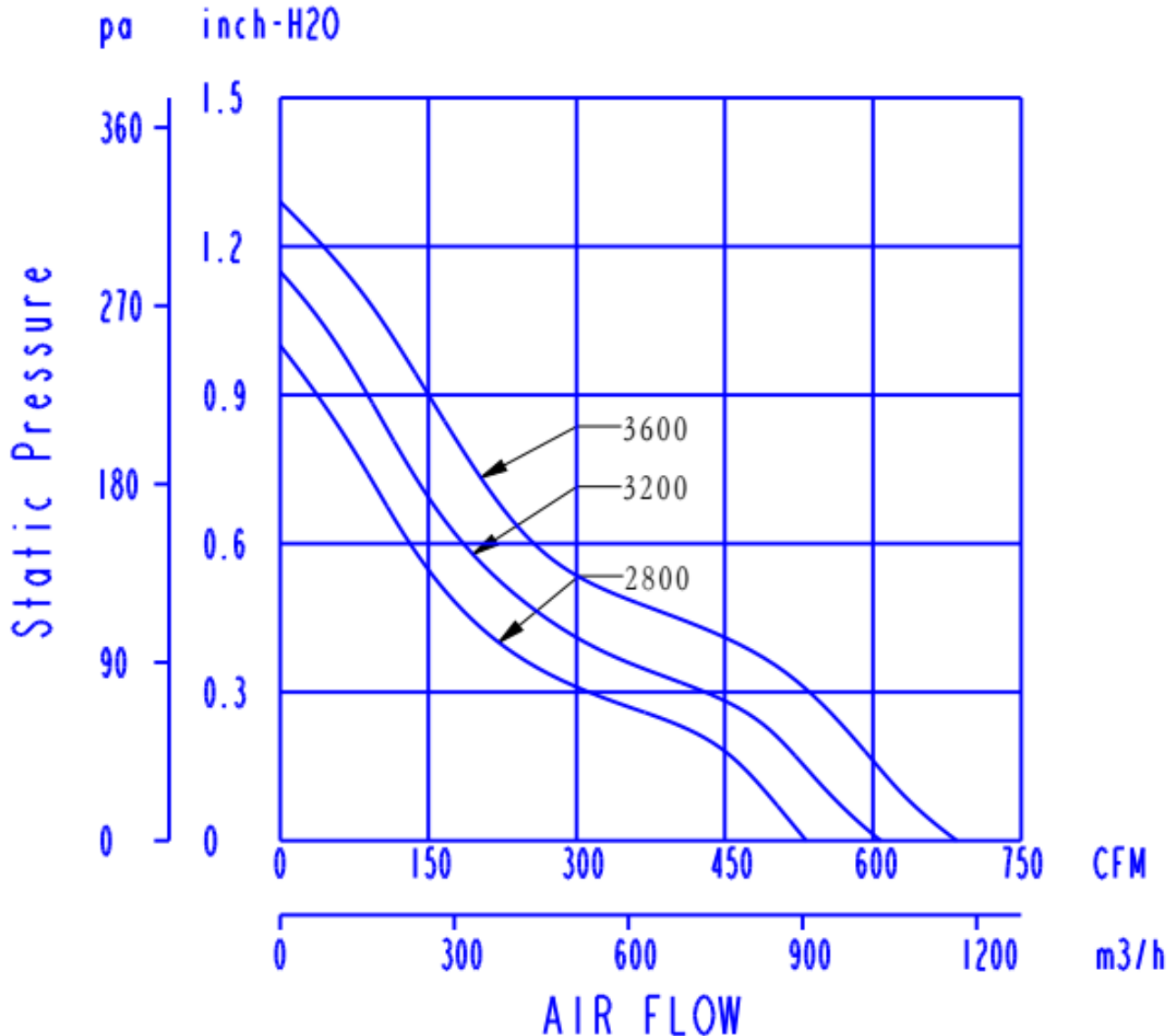



Comair Rotron Specification Sheet

Specification Date: Feb 01, 2018

Version: 01

E.) TERMINATION

Terminal connection:

Suit with terminal block

Blue = Neutral wire

Brown = Live wire

Yellow/Green = Ground wire

F.) RELIABILITY

Bearing type	Temperature	Hours
Ball bearing	20°C	60,000
	40°C	50,000
	60°C	40,000
	90°C	20,000

G.) SAFETY

UL, CUL, CE

H.) FLAMMABILITY

The fan including all components meets a UL94V-0 rating or better.