



The Future of Analog IC Technology®

EV8795H-LE-00A

High Efficiency, 20A, 16V Synchronous Step-down Converter Evaluation Board

DESCRIPTION

The EV8795H-LE-00A is an evaluation board for the MP8795H, a high efficiency, monolithic, synchronous step-down converter.

The EV board can deliver 20A continuous load current over a wide operating input range. High efficiency can be achieved over a wide output current load range.

The MP8795H adopts internally compensated constant-on-time (COT) control mode that provides fast transient response and eases loop stabilization.

This EV board can be turned on or off via a remote ON/OFF input (EN) that is referenced to ground. This input is compatible with popular logic devices.

ELECTRICAL SPECIFICATION

Parameter	Symbol	Value	Units
Input Voltage	V _{IN}	8-16	V
Output Voltage	V _{OUT}	1	V
Output Current	I _{OUT}	20	A

FEATURES

- Wide Input Voltage Range from 2.7V:
 - 2.7V to 16V with External 3.3V VCC Bias
 - 4V to 16V with Internal VCC Bias or External 3.3V VCC Bias
- Differential Output Voltage Remote Sense
- Programmable Accurate Current Limit Level
- 20A Output Current
- Low R_{DS(ON)} Integrated Power MOSFETs
- Adaptive COT for Ultrafast Transient Response
- Stable with Zero-ESR Output Capacitor
- Forced-CCM Operation
- Excellent Load Regulation
- Output Voltage Tracking
- Output Voltage Discharge
- PGOOD Active Clamped Low Level during Power Failure
- Programmable Soft Start Time from 1ms
- Pre-Bias Start up
- Selectable Switching Frequency of 600kHz, 800kHz and 1000kHz
- Non-latch OCP, OVP, UVP, UVLO, Thermal Shutdown
- Output Adjustable from 0.6V to 90%*V_{in}, Up to 5.5V max.
- Available in a QFN3X4 mm Package

APPLICATIONS

- Flat-Panel Televisions and Monitors
- Multi-Functional Printers
- Access Points and Routers
- Optical Modules

All MPS parts are lead-free, halogen free, and adhere to the RoHS directive. For MPS green status, please visit MPS website under Quality Assurance.

"MPS" and "The Future of Analog IC Technology" are Registered Trademarks of Monolithic Power Systems, Inc.

EV8795H-LE-00A EVALUATION BOARD

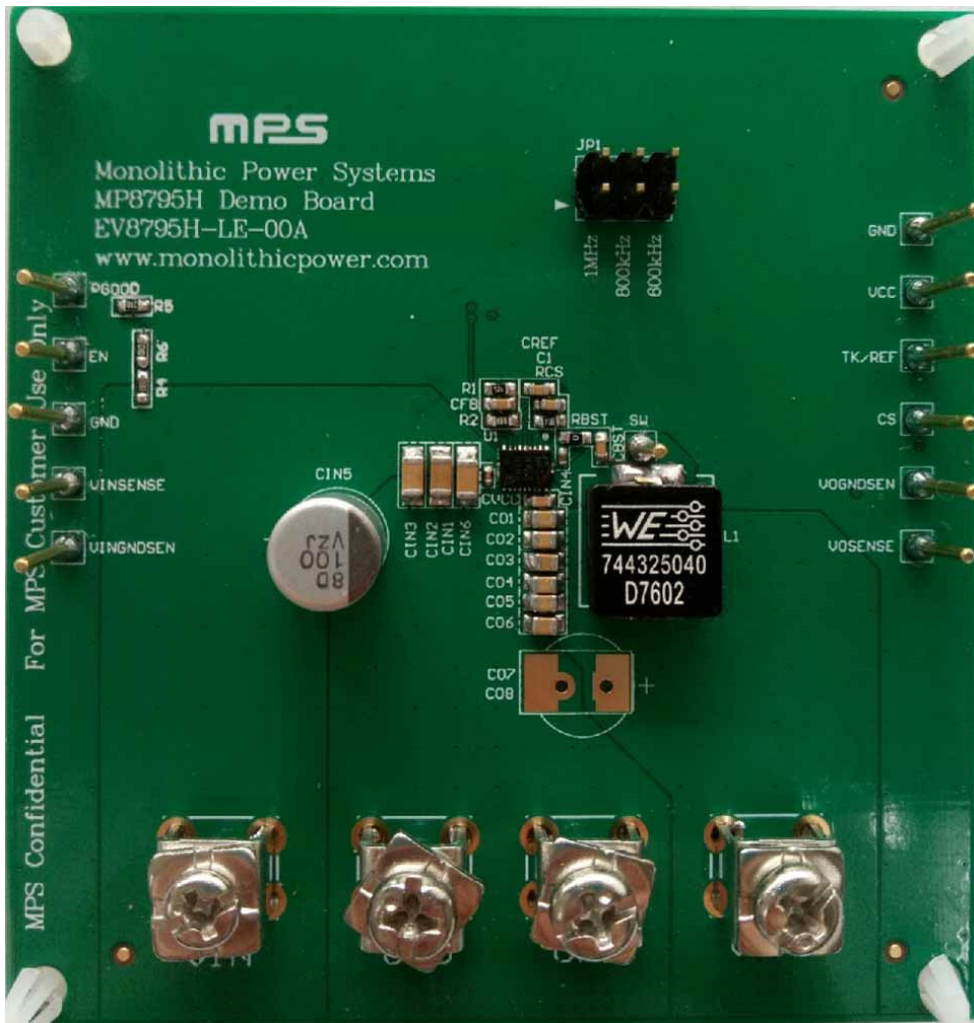

(L x W x H)81.3 mm x 77.5mm x 1.6 mm)

Board Number	MPS IC Number
EV8795H-LE-00A	MP8795HGLE

EVALUATION BOARD SCHEMATIC

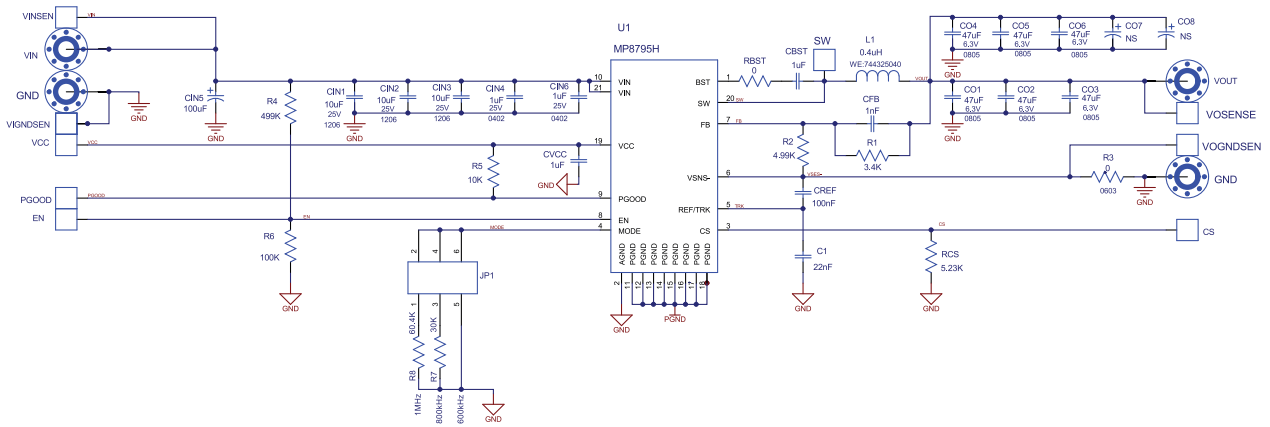

EV8795H-LE-00A BILL OF MATERIALS

Qty	Ref	Value	Description	Package	Manufacturer	Part Number
1	C1	22nF	Ceramic Cap.,25V,X7R	0603	Wurth	885012206067
2	CBST, CVCC	1μF	Ceramic Cap.,16V,X7R	0603	Wurth	885012206052
1	CFB	1nF	Ceramic Cap.,50V,X7R	0603	Wurth	885012206083
3	CIN1, CIN2, CIN3	10μF	Ceramic Cap.,25V,X5R	1206	Murata	GRM188R61E106MA73L
2	CIN4, CIN6	1μF	Ceramic Cap.,25V,X5R	0402	Murata	GRM155R61E105KA12D
1	CIN5	100μF	100μF 25V +-20%	DIP	NIPPON CHEMI-CON	EMZJ350ARA101MHA0G
6	CO1, CO2, CO3, CO4, CO5, CO6	47μF	Ceramic Cap.,6.3V,X5R	0805	Wurth	885012107006
0	CO7, CO8	NS				
1	CREF	100NF	Ceramic Cap.,25V,X7R	0603	Wurth	885012206071
1	R1	3K4	Film Res,1%,0603,3K4	0603	YAGEO	RC0603FR-073K4L
1	R2	4K99	Film Res,1%,0603,4K99	0603	YAGEO	RC0603FR-074K99L
2	R3, RBST	0R	Film Res,1%,0603,0R	0603	YAGEO	RC0603FR-070RL
1	R4	499K	Film Res,1%,0603,499K	0603	YAGEO	RC0603FR-07499KL
1	R5	10K	Film Res,1%,0603,10K	0603	YAGEO	RC0603FR-0710KL
1	R6	100K	Film Res,1%,0603,100K	0603	YAGEO	RC0603FR-07100KL
1	R7	30K	Film Res,1%,0603,30K	0603	YAGEO	RC0603FR-0730KL
1	R8	60K4	Film Res,1%,0603,60K4	0603	YAGEO	RC0603FR-0760K4L
1	RCS	5K23	Film Res,1%,0603,5K23	0603	YAGEO	RC0603FR-075K23L
1	L1	0.4μH	Inductor	10x10mm	Wurth	744325040
1	U1	MP8795 HGLE	16V/20A Step Down Convert	QFN21- 3x4mm	MPS	MP8795HGLE

EVB TEST RESULTS

Performance waveforms are tested on the EV8795H-LE-00A evaluation board.

$V_{IN} = 12V$, $V_{OUT} = 1V$, $L = 400nH$, $T_A = +25^{\circ}C$, unless otherwise noted.

Efficiency

$L=0.4\mu H$, 800kHz

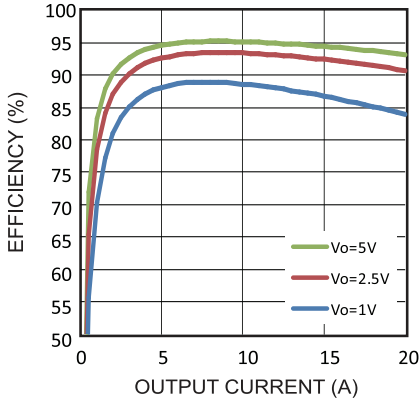

Thermal Results

800kHz, No Air-Flow

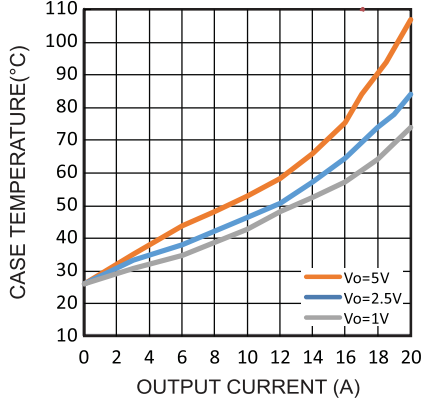

Switching Frequency vs. Output Current

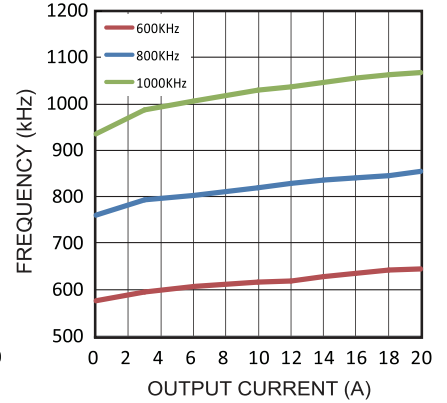

Output Voltage Load Regulation

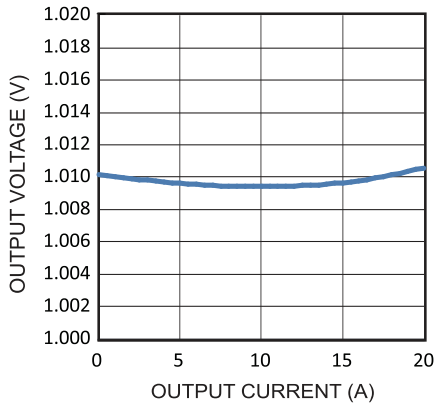

EVB TEST RESULTS (continued)

Performance waveforms are tested on the EV8795H-LE-00A evaluation board.

 $V_{IN} = 12V$, $V_{OUT} = 1V$, $L = 560nH$, $T_A = +25^{\circ}C$, unless otherwise noted.

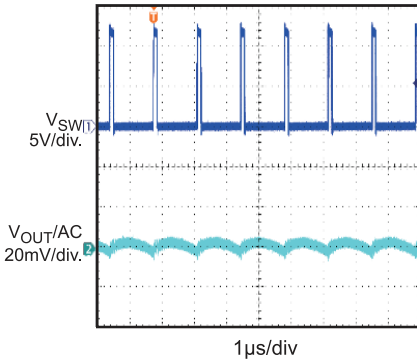
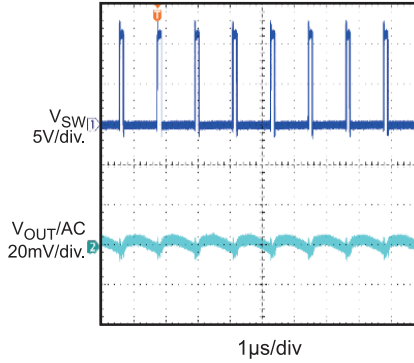
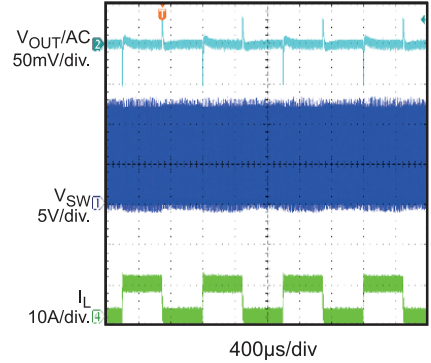
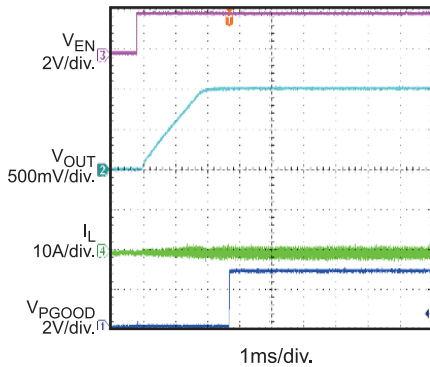
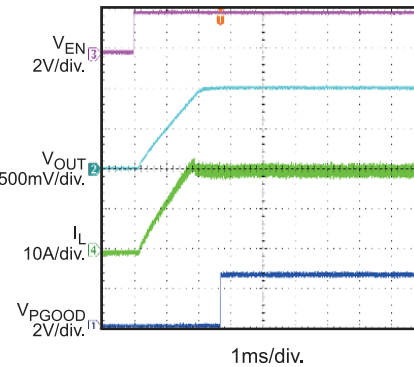
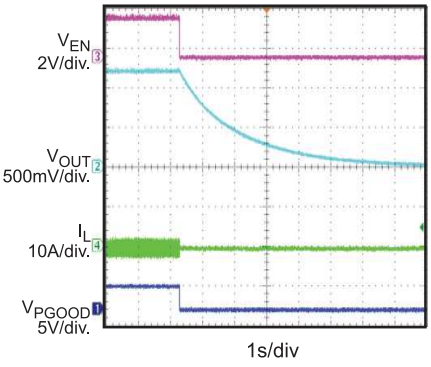
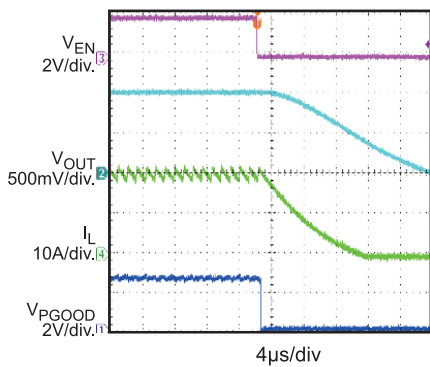
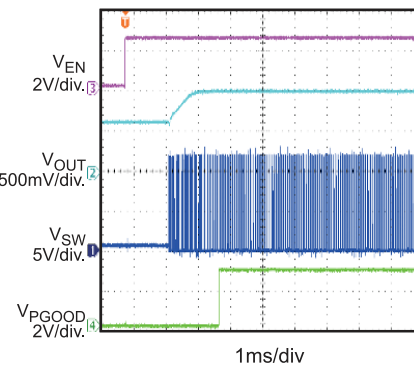
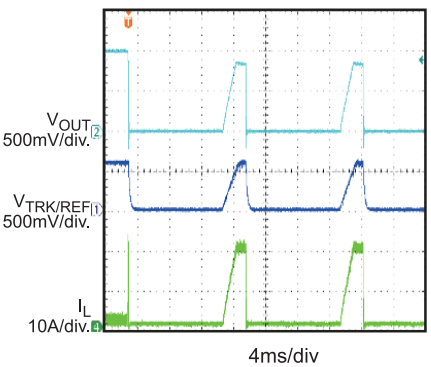
Steady State
 $I_{OUT} = 0A$

Steady State
 $I_{OUT} = 20A$

Load Transient
 $I_{OUT} = 0A \sim 8A$

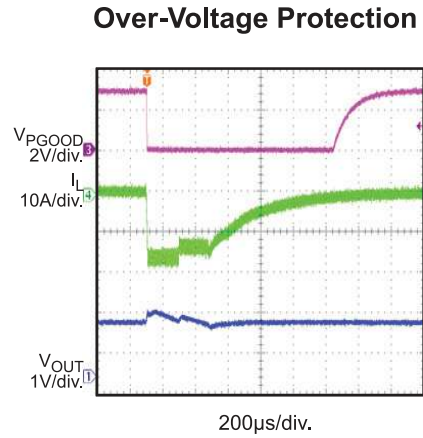
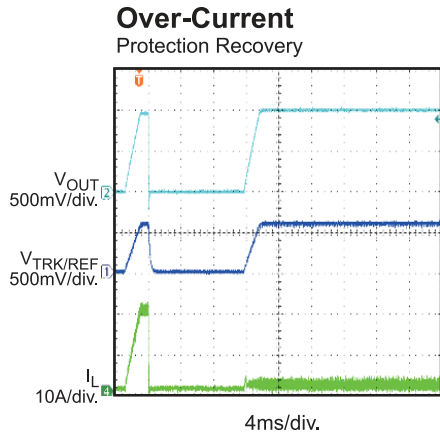
Power Up through EN
 $I_{OUT} = 0A$

Power Up through EN
 $I_{OUT} = 20A$

Power Down through EN
 $I_{OUT} = 0A$

Power Down through EN
 $I_{OUT} = 20A$

Pre-bias Start-Up

Over-Current Protection Entry

EVB TEST RESULTS (continued)

Performance waveforms are tested on the EV8795H-LE-00A evaluation board.

 $V_{IN} = 12V$, $V_{OUT} = 1V$, $L = 560nH$, $T_A = +25^{\circ}C$, unless otherwise noted.

PRINTED CIRCUIT BOARD LAYOUT

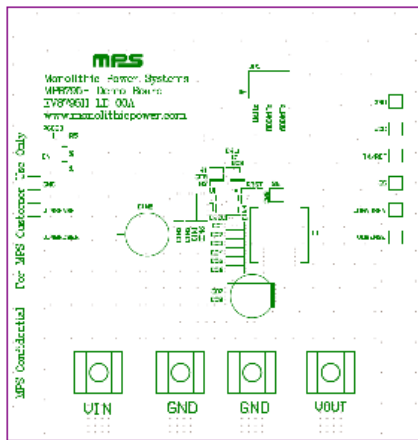

Figure 1—Top Silk Layer

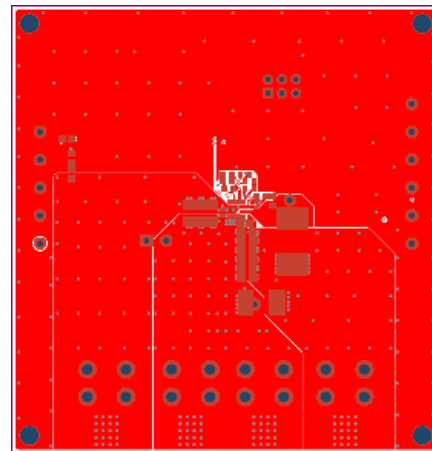

Figure 2—Top Layer

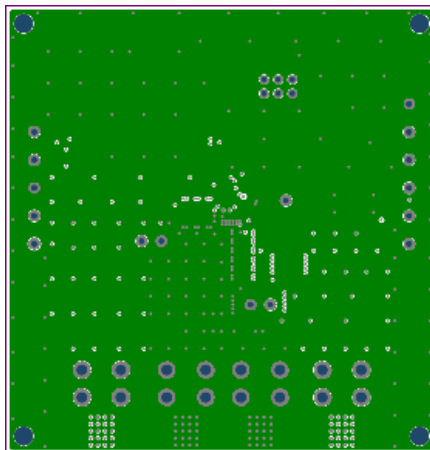

Figure 3—Inner Layer 1

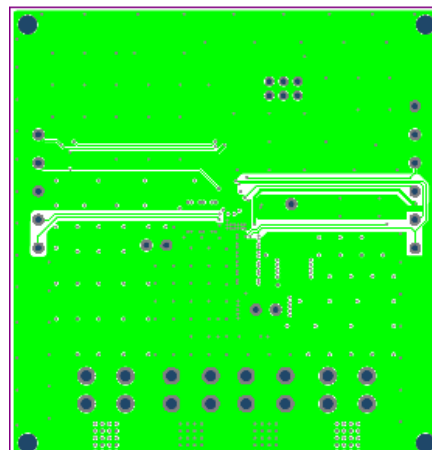

Figure 4— Inner Layer 2

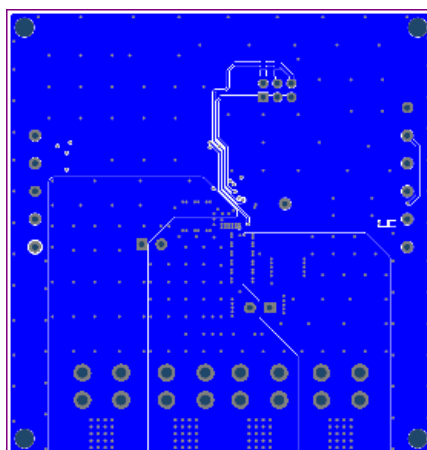

Figure 5—Bottom Layer

QUICK START GUIDE

The input voltage of the EV board can range from 8V to 16V. The minimum 8V input voltage is limited by the EN signal, which is derived from VIN through a resistor divider (R4 and R6). Lower input voltage (as low as 2.7V) can be set by fine tuning the resistor divider values, or by over-driving the EN with an external control signal. The following is the procedure to turn on the EV board.

1. Connect the positive and negative terminals of the load to the VOUT and GND pins, respectively.
2. Preset the power supply output voltage between 8V and 16V, and then turn off the power supply.
3. Connect the positive and negative terminals of the power supply output to the VIN and GND pins, respectively. Make sure the power supply has high enough current limit to supply the power.
4. Turn the power supply on. The EV8795H-LE-00A will automatically startup.
5. To use the Enable function, apply a digital input to the EN pin. Drive EN higher than 1.5V to turn on the regulator or less than 1V to turn it off.
6. Use R1 and R2 to set the output voltage with $V_{FB} = 0.6\text{ V}$. Follow the Application Information section in the device datasheet to select the proper values of R1, R2, inductor and output capacitor values when output voltage is changed.
7. The JP1 jumper can be used to select the operating frequency (600KHz, 800KHz and 1000KHz).

NOTICE: The information in this document is subject to change without notice. Please contact MPS for current specifications. Users should warrant and guarantee that third party Intellectual Property rights are not infringed upon when integrating MPS products into any application. MPS will not assume any legal responsibility for any said applications.