

Dual-pushbutton switch

A8N

Dual-Pushbutton Switch for High Capacity Switching



- Miniature size with High current 16A switching.
- Easy to mount by snap fitting.
- Dust & waterproof construction with panel seal (Equivalent to IP67 (IEC-60529)).
- UL, cUL and TV-8 standard approved. Conforms to EN standards.



RoHS Compliant

Caution
Refer to Precautions

List of Models

Contact Form	SPST	DPST	Quantity per box
Color of button	White/Red	White/Red	
Color of cases	Black	Black	
Marking on caps			
	A8NS-3162	A8ND-3162	100

Ratings

Rated load	Non-inductive	Inductive	
	Resistive load	Inductive load	Inductive motor load
125 VAC	16A	16A	10A
250 VAC	16A	16A	10A

- Note:**
1. The inductive load has a power factor of 0.7 minimum (AC).
 2. The motor load has an impulse current 6 times the normal current.
 3. The above ratings were tested under the following conditions:
 - (1) Ambient temperature: 20±2 °C
 - (2) Ambient humidity: 65±5 %RH
 - (3) Switching frequency: 7 times/min.

Approved Safety Standards

UL, cUL (UL1054/CSA C22.2 No. 55)

16A 125 VAC, 16A 250 VAC, TV-8

DEMKO (EN61058-1)

16A 125 VAC, 16A 250 VAC

Note: Quick connect terminals are not in compliance with IEC standards.

Characteristics

Permissible operating frequency	Mechanical	20 operations / min max.
	Electrical	7 operations / min max.
Insulation resistance		100 MΩ min. (at 500 VDC with insulation tester)
Contact resistance (initial value)		20 mΩ max. (6 to 8 VDC, 1 A, voltage drop method)
Dielectric strength	Between terminals of the same polarity	2,000 VAC 50/60Hz, for 1min
	Between terminal and case ground	4,000 VAC 50/60Hz, for 1min
Vibration resistance	Malfunction	10 to 55 Hz, 1.5-mm double amplitude
Shock resistance	Malfunction	1,000 m/s ² max.
Durability	Mechanical	50,000 operations min.
	Electrical	10,000 operations min.
Inrush current		117 A max.
Degree of protection		Panel seal IEC IP67
Ambient operating temperature		- 25 to +55 °C (at ambient humidity of 60 % max.) (with no icing or condensation)
Ambient operating humidity		25 to 85 %RH (at +15 to 35 °C)
Weight		9.6 g (SPST), 11.1 g (DPST)

■Dimensions (Unit: mm)

A8NS-3162

A8ND-3162

Note: The following illustrations and drawings are for 2 poles (DPST) models, 1 pole (SPST) models have single side terminals.

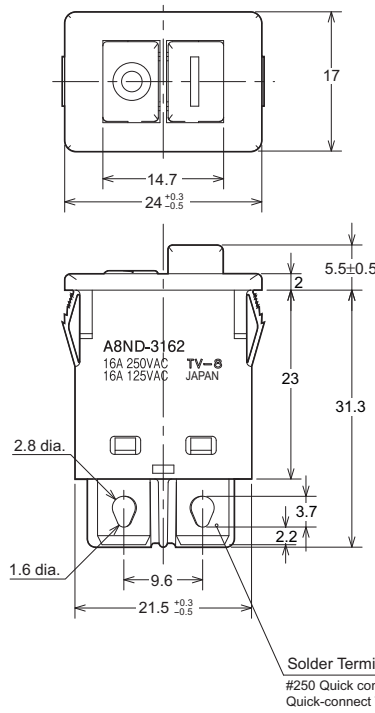
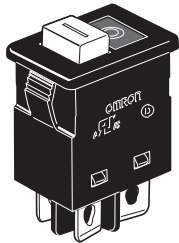

● Operating Characteristics

No. of poles	1 (SPST)	2 (DPST)
Operating force (OF) max.	9 N {918 gf}	22 N {2,243 gf}

Solder Terminal
 #250 Quick connect terminal (t=0.8) common use
 Quick-connect Terminals are not in compliance with IEC standards.

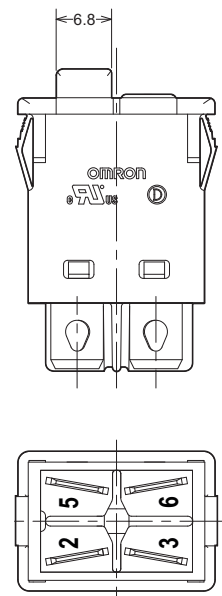

Note: Unless otherwise specified, a tolerance of ±0.3 mm applies to all dimensions.

■Panel Cutout

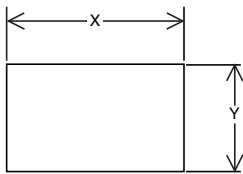

Panel thickness (mm)	X (mm)	Y (mm)
1.0 to 1.9	22.3 ⁰ _{-0.1}	14.8 ^{+0.1} ₀
2.0 to 2.8	23.2 ^{+0.1} ₀	

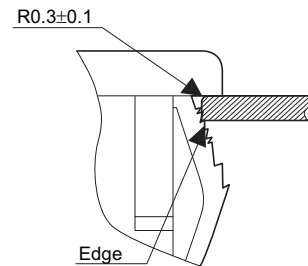

Process the above-mentioned R on the mounting hole side of panel, or be sure that the Play R is on the operation side of panel when using.
 Be sure that the Edge is on the reverse side of panel when processing.

■Precautions

Be sure to read the Safety precautions common to all Rocker Switches for correct use.

- Application examples provided in this document are for reference only. In actual applications, confirm equipment functions and safety before using the product.
- Consult your OMRON representative before using the product under conditions which are not described in the manual or applying the product to nuclear control systems, railroad systems, aviation systems, vehicles, combustion systems, medical equipment, amusement machines, safety equipment, and other systems or equipment that may have a serious influence on lives and property if used improperly. Make sure that the ratings and performance characteristics of the product provide a margin of safety for the system or equipment, and be sure to provide the system or equipment with double safety mechanisms.

Note: Do not use this document to operate the Unit.