

5223979-2 ✓ ACTIVE

Z-PACK 2mm HM

TE Internal #: 5223979-2

Backplane Guide Hardware, Guide Socket Module, Z-PACK 2mm HM

[View on TE.com >](#)



Connectors > PCB Connectors > Backplane Connectors > Backplane Guide Hardware

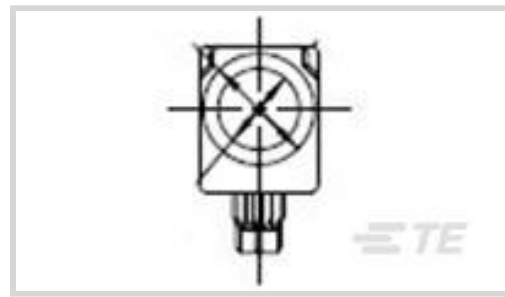

Connector Guide Hardware Type: **Guide Socket Module**

Features

Product Type Features

Connector Guide Hardware Type	Guide Socket Module
-------------------------------	---------------------

Configuration Features

PCB Mount Orientation	Right Angle
-----------------------	-------------

Body Features

Guide Component Plating Material Finish Process	Passivated
Guide Component Base Material	Zinc Alloy

Mechanical Attachment

Thread Size	M3 x .5
-------------	---------

Dimensions

Guide Length	34.2 mm[1.346 in]
Thread Length	16.75 mm[.66 in]

Product Compliance

[For compliance documentation, visit the product page on TE.com>](#)

EU RoHS Directive 2011/65/EU	Compliant
EU ELV Directive 2000/53/EC	Compliant
China RoHS 2 Directive MIIT Order No 32, 2016	No Restricted Materials Above Threshold
EU REACH Regulation (EC) No. 1907/2006	Current ECHA Candidate List: JUNE 2023 (235) Candidate List Declared Against: JAN 2023 (233) Does not contain REACH SVHC
Halogen Content	Low Halogen - Br, Cl, F, I < 900 ppm per

homogenous material. Also BFR/CFR/PVC Free

Solder Process Capability

Not applicable for solder process capability

Product Compliance Disclaimer

This information is provided based on reasonable inquiry of our suppliers and represents our current actual knowledge based on the information they provided. This information is subject to change. The part numbers that TE has identified as EU RoHS compliant have a maximum concentration of 0.1% by weight in homogenous materials for lead, hexavalent chromium, mercury, PBB, PBDE, DBP, BBP, DEHP, DIBP, and 0.01% for cadmium, or qualify for an exemption to these limits as defined in the Annexes of Directive 2011/65/EU (RoHS2). Finished electrical and electronic equipment products will be CE marked as required by Directive 2011/65/EU. Components may not be CE marked. Additionally, the part numbers that TE has identified as EU ELV compliant have a maximum concentration of 0.1% by weight in homogenous materials for lead, hexavalent chromium, and mercury, and 0.01% for cadmium, or qualify for an exemption to these limits as defined in the Annexes of Directive 2000/53/EC (ELV). Regarding the REACH Regulation, the information TE provides on SVHC in articles for this part number is based on the latest European Chemicals Agency (ECHA) 'Guidance on requirements for substances in articles' posted at this URL: <https://echa.europa.eu/guidance-documents/guidance-on-reach>

Compatible Parts



Also in the Series | Z-PACK 2mm HM

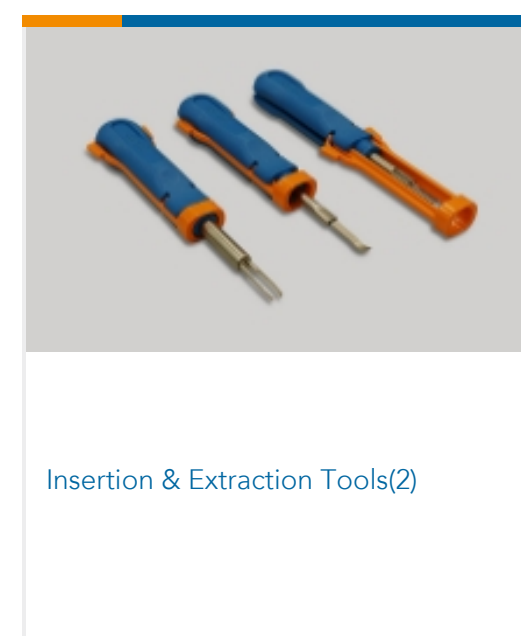
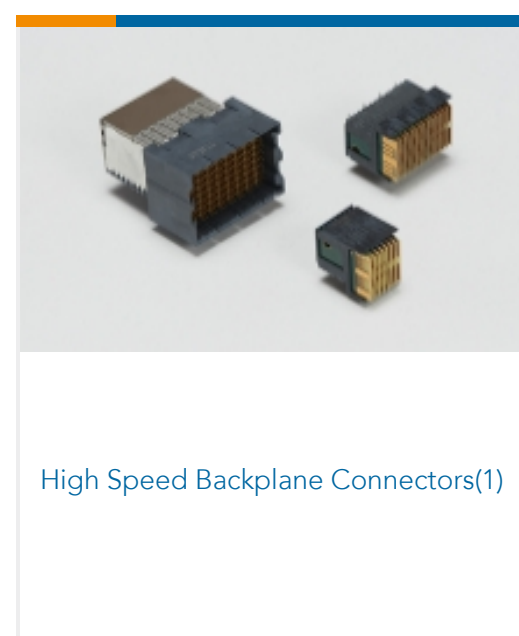
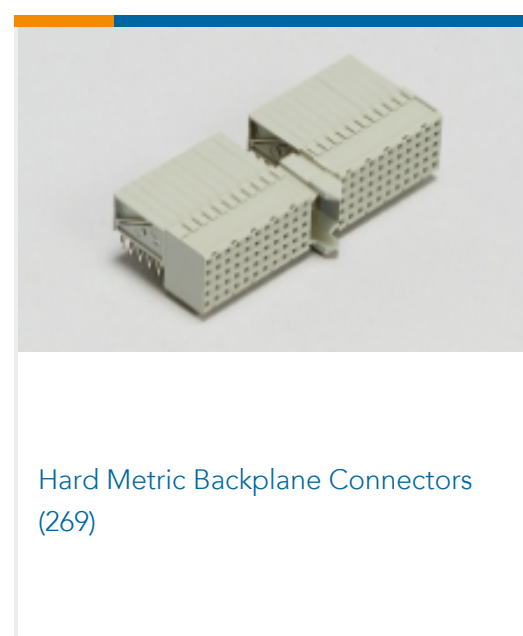
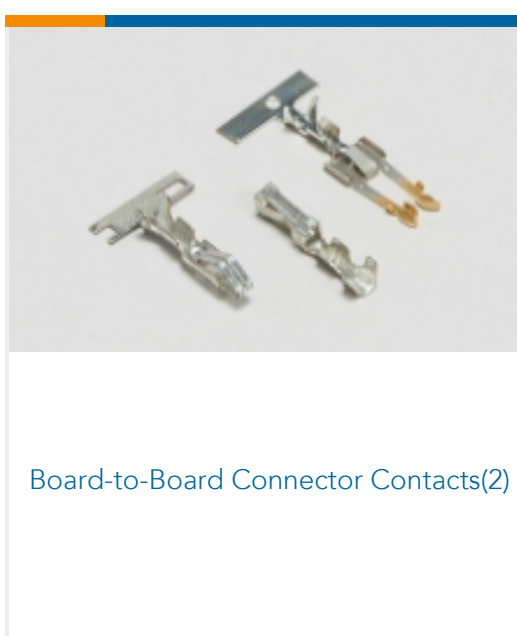
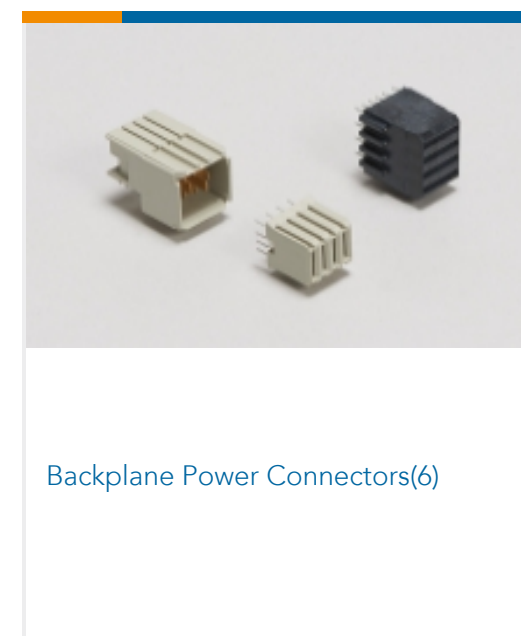
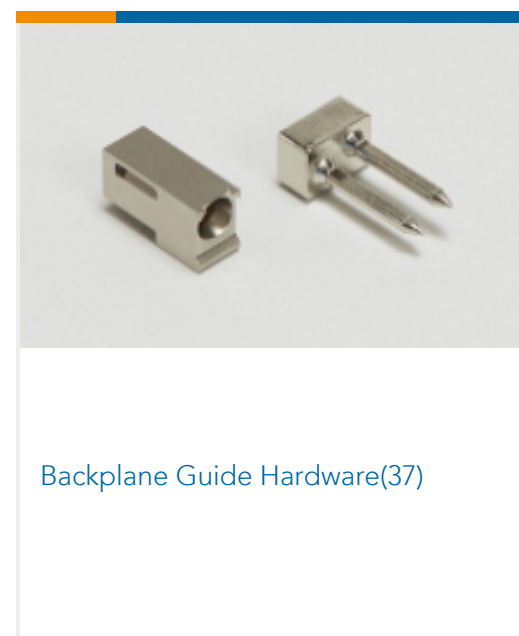
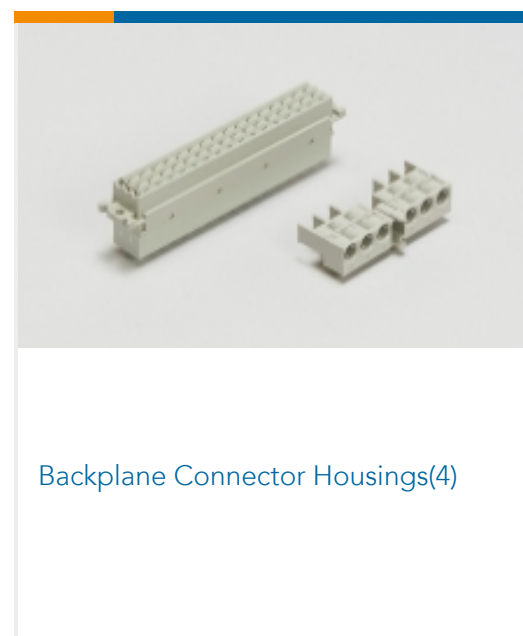
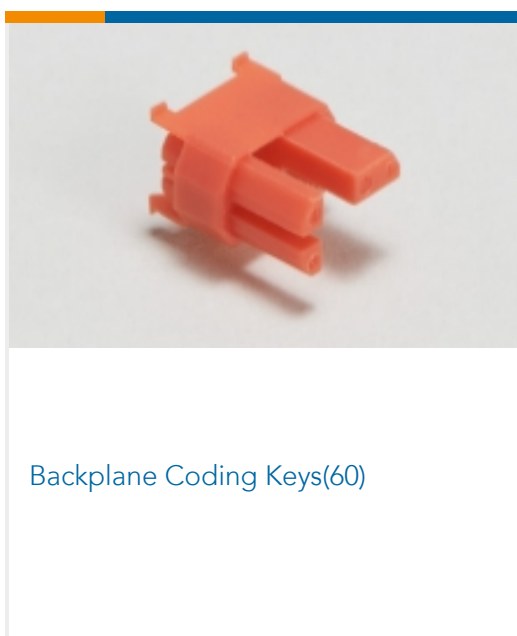

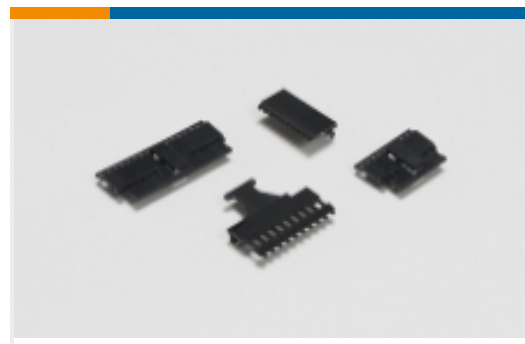

PCB Connector Covers(4)



PCB Connector Shrouds(39)



PCB Ferrules & Shields(19)



Rectangular Power Connectors(87)

Customers Also Bought



TE Part #2227838-7
2X12 ZSFP+ CONNECTOR ASSEMBLY



TE Part #2227669-1
zQSFP+ STACKED RECEPTACLE ASSEMBLY 2X1



TE Part #1-6450160-0
MBXL R/A RCPT 2P+24S+2P



TE Part #2170288-1
1X4 CAGE ASSEMBLY, THRU BEZEL, QSFP

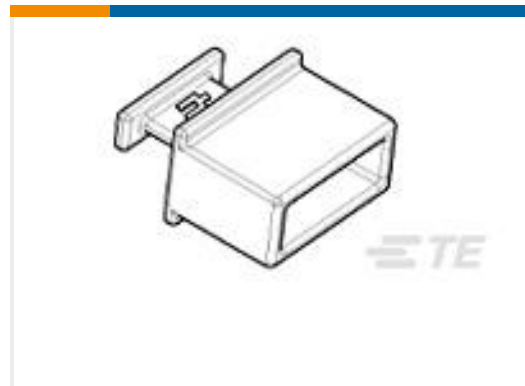

TE Part #1888810-2
EMI/Dust Cover,XFP And QSFP



TE Part #2170775-4
CAGE ASSY, 1X4, QSFP28, GASKET, HS, LP



TE Part #2007400-1
SFP+ 1x2 Cage Assy with Light Pipe



TE Part #2143313-2
IMP100S,H,RA2P16C,LG,OEWS39,4.9

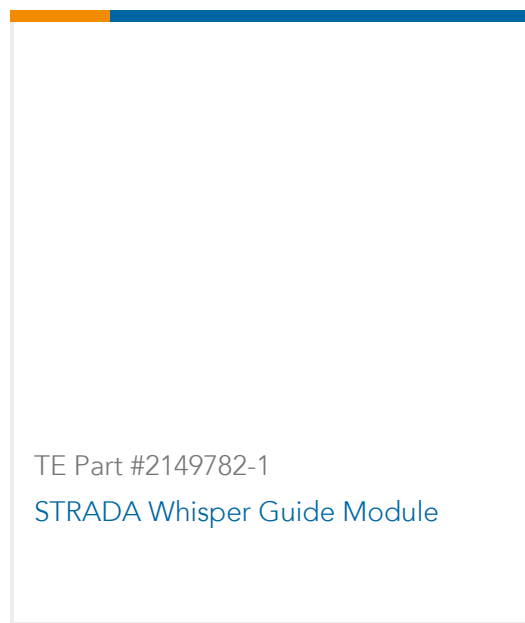

TE Part #2149782-1
STRADA Whisper Guide Module

Documents

Product Drawings

UPM GUIDE MODULE

English

CAD Files

3D PDF

3D

Customer View Model

ENG_CVM_CVM_5223979-2_1.2d_dxf.zip



English

Customer View Model

[ENG_CVM_CVM_5223979-2_1.3d_igs.zip](#)

English

Customer View Model

[ENG_CVM_CVM_5223979-2_1.3d_stp.zip](#)

English

By downloading the CAD file I accept and agree to the [Terms and Conditions](#) of use.

Product Specifications

[Engineering Report](#)

English

Product Environmental Compliance

[MD_5223979-2_03262014544_dmtec](#)

English

[MD_5223979-2_03262014544_dmtec](#)

English