

General Description

The MIC4555 is a digital level shifter with a 50mA LDO for SIM card interfaces. There are three high-speed level shifters for SIM card signal translation. The level shifters are designed to support high-speed clocking up to 5MHz. The 50mA LDO provides power for the SIM Card to eliminate the need for a separate power device. This simplifies the design of the SIM card interface. The MIC4555 is available in a tiny, lead-free, 16-pin MLF[®] package (3mm x 3mm), and is specified to operate from -40°C to +125°C junction temperature.

Data sheets and support documentation can be found on Micrel's web site at: www.micrel.com.

Features

- Powers 1.8V or 3V SIM up to 50mA
- Input voltage 2.7V to 5.5V
- Controller voltage 1.6V to 5.5V
- Supports clock rates greater than 5MHz
- 8kV ESD protection on SIM contact pins
- 16-pin 3mm x 3mm MLF[®] package
- -40°C to +125°C junction temperature range

Applications

- SIM card interface for 3G/4G systems
- Wireless PC cards
- Smart card readers

Typical Application

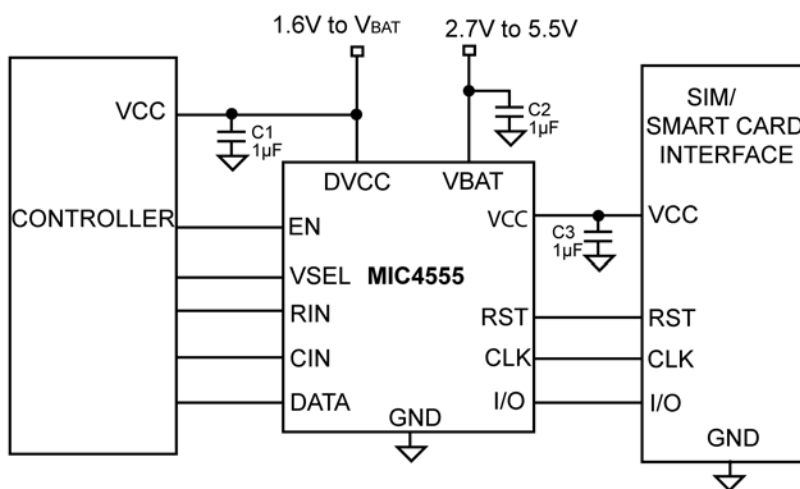

Typical SIM/SMART CARD Interface

Ordering Information

Part Number	Marking Code	LDO Output Voltage	Junction Temperature Range	Package
MIC4555YML	4555	1.8V/3.0V	-40°C to +125°C	3mm x 3mm 16-Pin MLF®

Pin Configuration

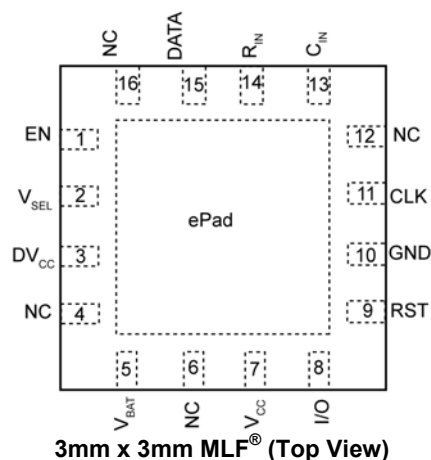

Pin Description

Pin Number	Pin Name	Description
1	EN	Enable input from controller. This pin should be high (DV_{CC}) for normal operation and low (<0.4V) to activate a low-current shutdown mode.
2	V_{SEL}	V_{CC} voltage select input from the controller. A low level selects $V_{CC} = 1.8V$ while driving this pin to DV_{CC} selects $V_{CC} = 3V$.
3	DV_{CC}	Supply Voltage for the Controller Side I/O Pins (C_{IN} , R_{IN} , DATA). When below 1.1V typical, the V_{CC} supply is disabled. This pin should be bypassed with a 1 μ F ceramic capacitor close to the pin.
4	N/C	Not Connected.
5	V_{BAT}	SIM LDO supply input. This pin can function between 2.7V and 5.5V for normal operation. This pin should be bypassed with a 1 μ F ceramic capacitor close to the pin.
6	N/C	Not Connected
7	V_{CC}	SIM LDO output provides SIM card V_{CC} supply. A 1 μ F low-ESR capacitor should be connected close to the V_{CC} pin for stable operation. This pin is discharged to GND during shutdown.
8	I/O	SIM Data I/O. The SIM card output must be on an open drain driver capable of sourcing >1mA.
9	RST	Reset output pin for the SIM card.
10	GND	Common ground for the SIM and controller side.
11	CLK	Clock output pin for the SIM Card. This pin is pulled to ground during shutdown.
12	N/C	Not Connected.
13	C_{IN}	Clock input from the controller.

Pin Description (Continued)

Pin Number	Pin Name	Description
14	R _{IN}	Reset input from the controller.
15	DATA	Controller side data I/O. This pin is used for bidirectional data transfer. The controller output must be an open-drain configuration. The open drain output must be capable of sinking greater than 1mA.
16	N/C	Not Connected
ePad	HS Pad	Heat sink pad. Connect to GND.

Absolute Maximum Ratings⁽¹⁾

Supply Voltages (DV_{CC} , V_{BAT} , V_{CC} , V_{SEL}).....	-0.3 to +6.0V
Input Logic (R_{IN} , C_{IN} , DATA) ⁽²⁾	-0.3 to +6.0V
Lead Temperature (soldering, 5s).....	260°C
Storage Temperature (T_S).....	-65 to +150°C
ESD Rating ⁽³⁾	2kV to Any Pin
ESD Rating (RST, CLK, I/O, V_{CC} pins) ⁽³⁾	8kV to GND

Operating Ratings⁽⁴⁾

Supply Voltage (V_{BAT}).....	+2.7V to +5.5V
Supply Voltage (DV_{CC}).....	+1.6V to V_{BAT}
Logic Inputs (R_{IN} , C_{IN} , DATA).....	0V to DV_{CC}
Logic Inputs (EN, V_{SEL}).....	0V to V_{BAT}
Storage Temperature (T_S).....	-45 to +125°C
Package Thermal Resistance 3mm x 3mm MLF [®] -16L (θ_{JA}).....	59°C/W

Electrical Characteristics – General

$T_A = 25^\circ\text{C}$, $V_{BAT} = 4.3\text{V}$, $C_{VCC} = 1\mu\text{F}$ unless otherwise noted. **Bold** values indicate $-40^\circ\text{C} \leq T_J \leq 125^\circ\text{C}$.

Parameter	Symbol	Condition	Min.	Typ.	Max.	Unit
V_{BAT} Shutdown Current	I_{SD}	$V_{EN} = 0\text{V}$, All outputs disabled		0.1	1	μA
V_{BAT} Operating Current	I_{OPBAT}	$V_{CC} = 1.8\text{V}$, $I_{CC} = 0\text{mA}$		41	80	μA
		$V_{CC} = 3.0\text{V}$, $I_{CC} = 0\text{mA}$		47	80	
DV_{CC} Shutdown Current	I_{SD}	$V_{EN} = 0\text{V}$, All outputs disabled		0.1	1	μA
DV_{CC} Operating Current	$I_{OPDV_{CC}}$	$f_{CLK} = 1\text{MHz}$, $t_{rf} = 10\text{ns}$, $DV_{CC} = 5.5\text{V}$		3.5		μA
DV_{CC} Undervoltage Lock-Out Threshold (UVLO)	V_{UVLO}		0.8	1.1	1.4	V
Over-Temperature Shutdown Threshold	T_{th}			150		$^\circ\text{C}$
Over-Temperature Hysteresis	T_{hys}			10		$^\circ\text{C}$
Auto Discharge NFET Resistance ⁽⁵⁾	R_{PD}	When disabled, $I_{OUT} = 3\text{mA}$. Active pull-down on V_{CC} .		260		Ω
		When disabled, $I_{OUT} = 3\text{mA}$. Active pull-down on RST, CLK.		100		

Electrical Characteristics – SIM Power Supply and Level Translator

$T_A = 25^\circ\text{C}$, $V_{BAT} = 4.3\text{V}$, $C_{VCC} = 1\mu\text{F}$ unless **Bold** values indicate $-40^\circ\text{C} \leq T_J \leq 125^\circ\text{C}$.

Parameter	Symbol	Condition	Min.	Typ.	Max.	Unit
EN, V_{SEL} High Input Threshold	V_{IH}				1.2	V
EN, V_{SEL} Low Input Threshold	V_{IL}		0.4			V
Controller Voltage Input	DV_{CC}		1.6		V_{BAT}	V
RIN, CIN High Input Threshold	V_{IH}				0.7 DV_{CC}	V
RIN, CIN Low Input Threshold	V_{IL}		0.2 DV_{CC}			V
DATA Output High	V_{OH}	$I_{OH} = 20\mu\text{A}$, I/O = V_{CC}	0.7 DV_{CC}			V
DATA Output Low	V_{OL}	$I_{OL} = -200\mu\text{A}$, I/O = 0V			0.4	V
DATA Input Current High	I_{IH}		-20		20	μA
DATA Input Current Low	I_{IL}				1	mA
DATA Pull-Up Resistance	R_{PU}	Between DATA and DV_{CC}	13	20	30	k Ω

Electrical Characteristics – SIM Power Supply and Level Translator (Continued)

$T_A = 25^\circ\text{C}$, $V_{BAT} = 4.3\text{V}$, $C_{VCC} = 1\mu\text{F}$ unless **Bold** values indicate $-40^\circ\text{C} \leq T_J \leq 125^\circ\text{C}$.

Parameter	Symbol	Condition	Min.	Typ.	Max.	Unit
Output Voltage Accuracy	V_{ACC}	3.0V Output @ 50mA and 1mA	2.7	3	3.3	V
		1.8V Output @ 50mA and 1mA	1.62	1.8	2.0	
V_{CC} Turn-On Time	t_{on}			60		μs
Current Limit (V_{CC})	I_{OUT}		60			mA
Output High Voltage	V_{OH}	RST, CLK $I_{OH} = 20\mu\text{A}$	$0.8V_{CC}$			V
Output Low Voltage	V_{OL}	RST, CLK $I_{OL} = -200\mu\text{A}$			0.4	V
Output High Voltage	V_{OH}	DATA = DV_{CC} , $I_{OH} = 20\mu\text{A}$	$0.8V_{CC}$			V
Output Low Voltage	V_{OL}	DATA = 0V, $I_{OL} = -1\text{mA}$			0.4	V
I/O Pull-Up Resistance	R_{PU}	Between I/O and V_{CC}	6.5	10	14	k Ω
CLK Rise/Fall Time	$t_{r/f}$	$C_{CLK}, C_{I/O} = 30\text{pF}$ (20 – 80%)		18		ns
RST, I/O Rise/Fall Time	$t_{r/f}$	$C_{RST}, C_{I/O} = 30\text{pF}$ (20 – 80%)		20		ns
Maximum CLK Frequency	f_{CLKMAX}		5			MHz

Notes:

1. Exceeding the absolute maximum rating may damage the device.
2. Exceeding the maximum differential input voltage will damage the input stage and degrade performance (input bias current is likely to increase).
3. Devices are ESD sensitive. Handling precautions recommended. Human body model, 1.5k Ω in series with 100pF.
4. The device is not guaranteed to function outside its operating rating.
5. Specification for packaged product only.

Typical Characteristics

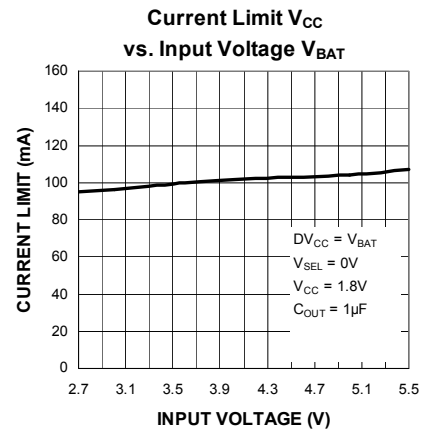
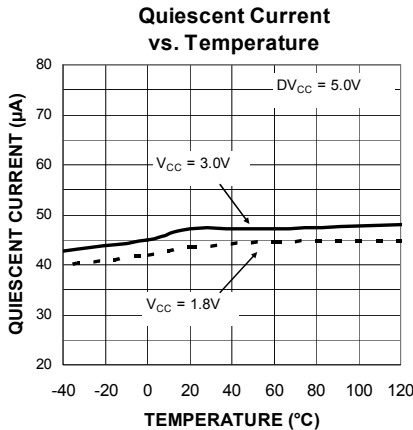
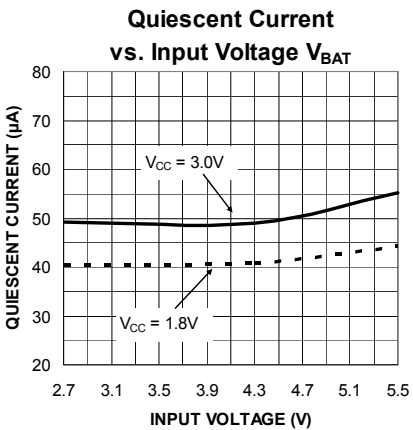
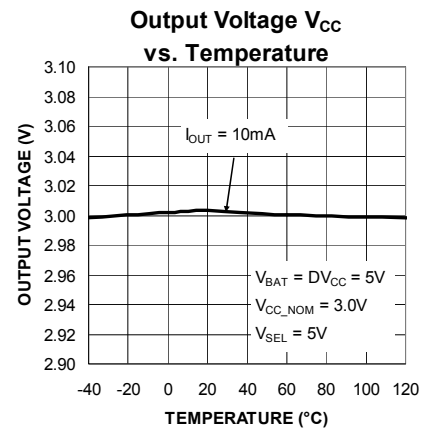
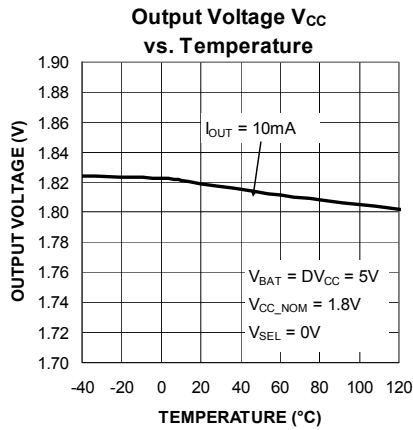
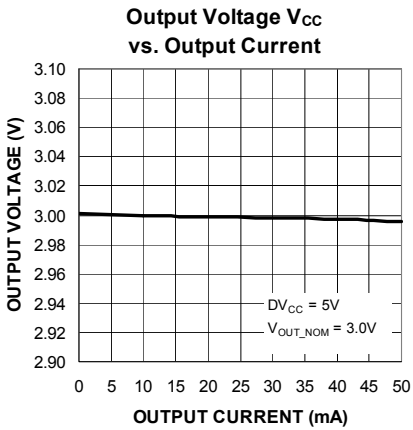
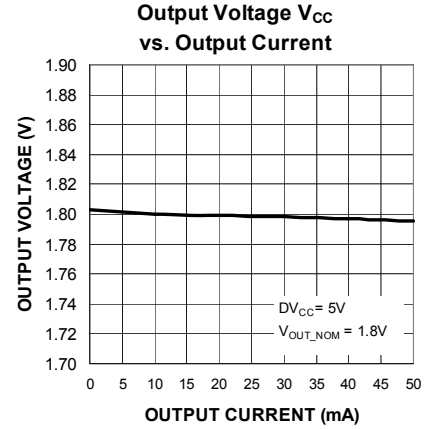
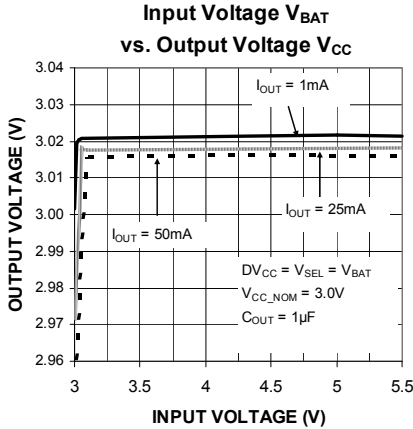
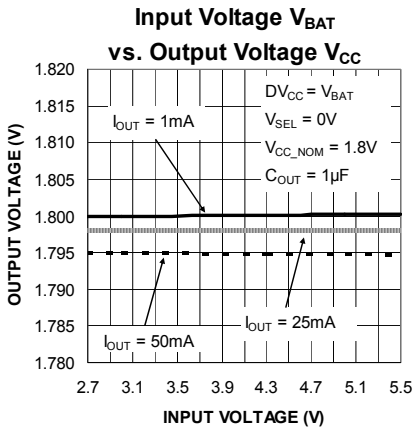

Typical Characteristics (Continued)

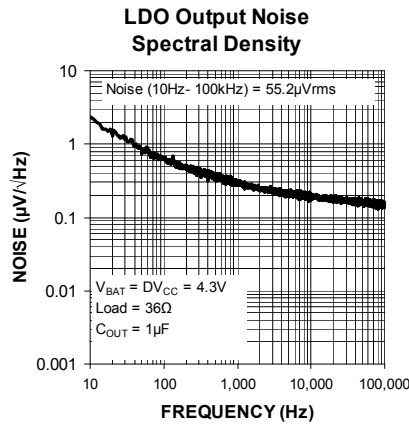
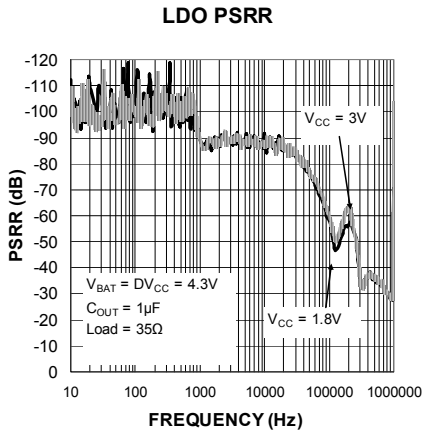
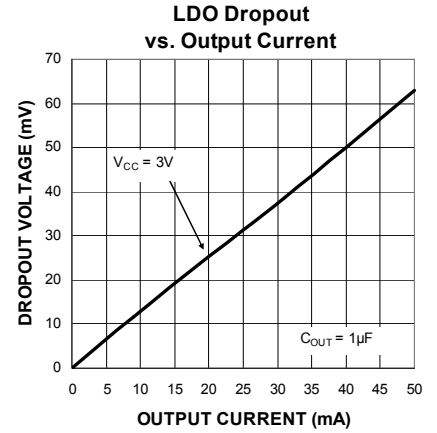
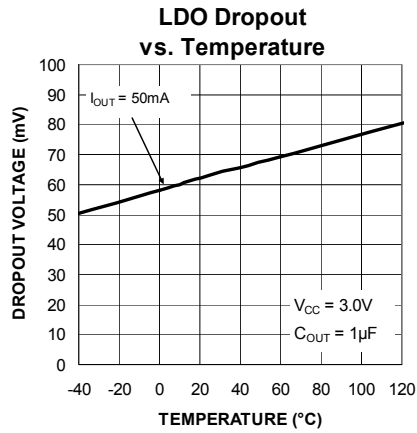
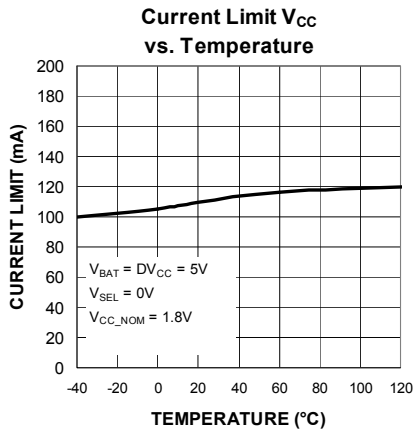

Functional Characteristics

Input: RIN and Output: RST

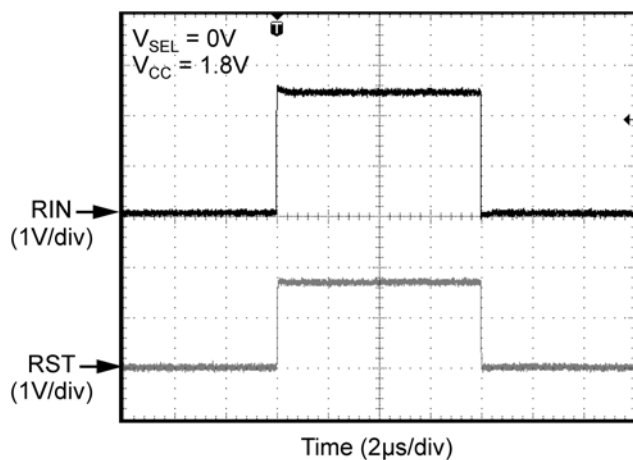

Input: RIN and Output: RST

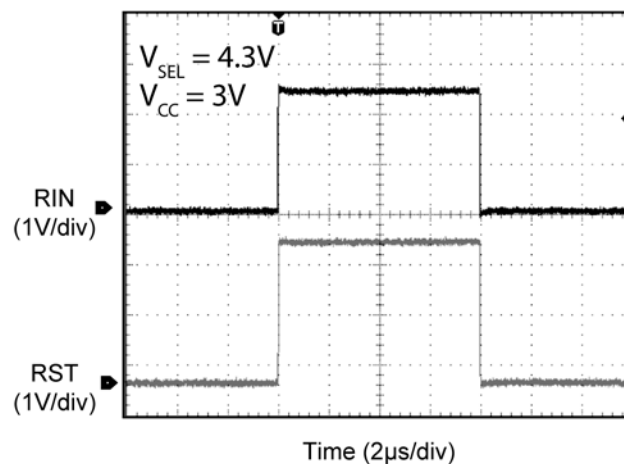

Input: CIN and Output: CLK

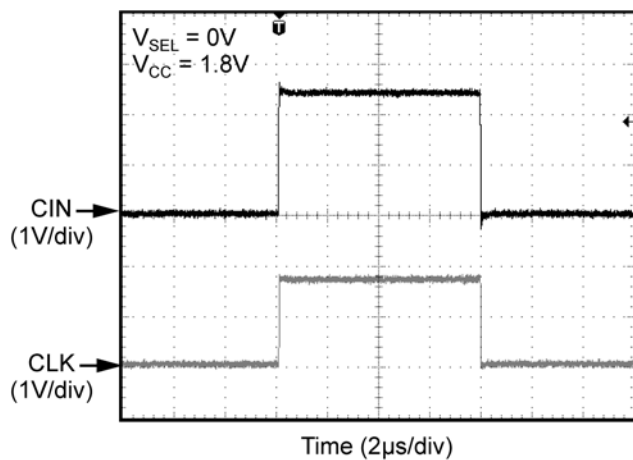

Input: CIN and Output: CLK

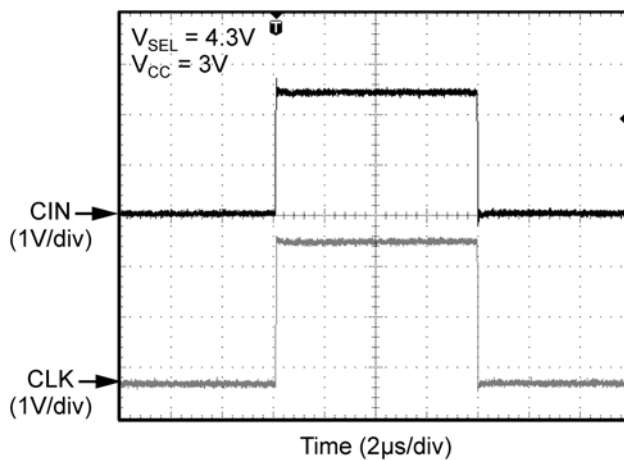

Input: DATA and Output: I/O

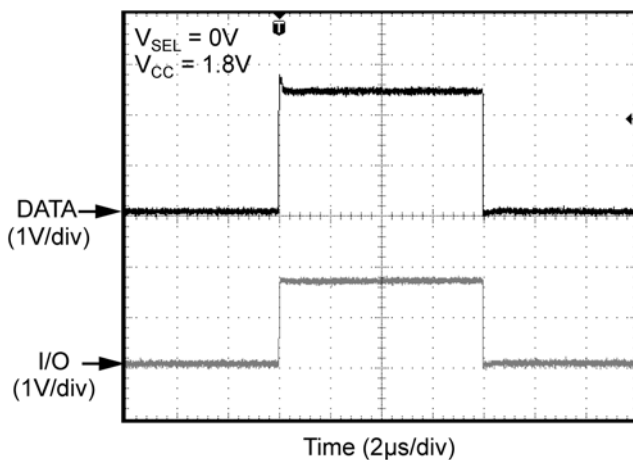

Input: DATA and Output: I/O

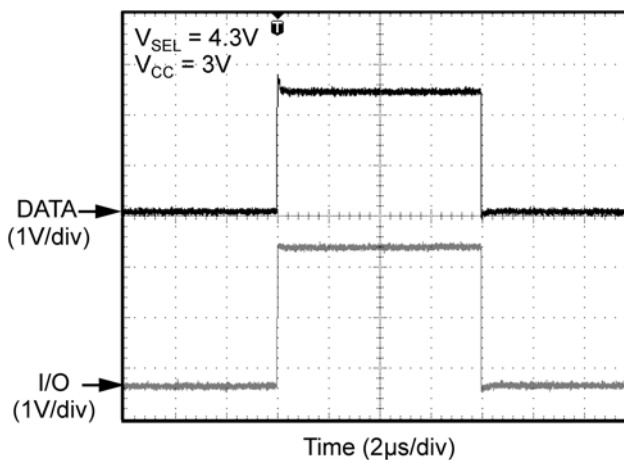

Functional Characteristics (Continued)

Input: IO and Output: DATA

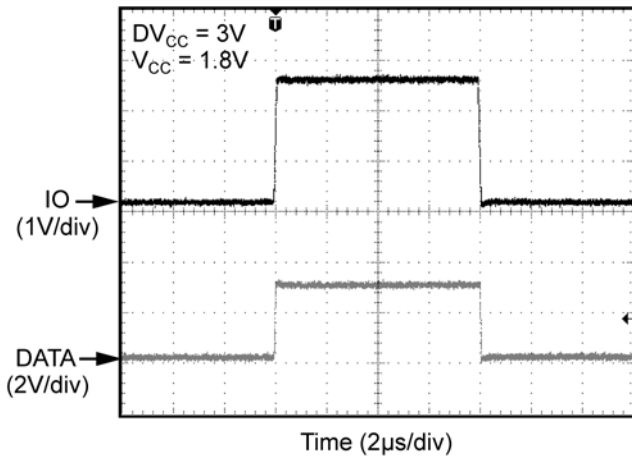

Input: IO and Output: DATA

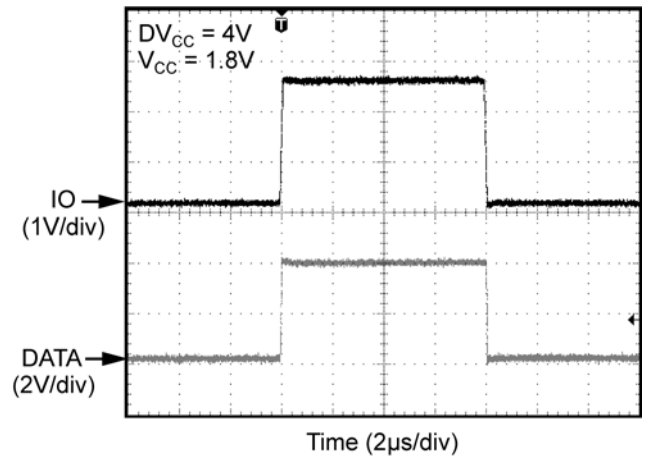

Load Transient 1mA to 50mA

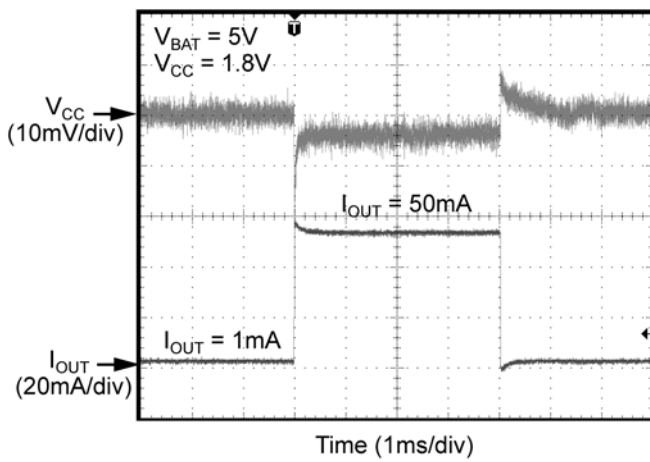

Load Transient 1mA to 50mA

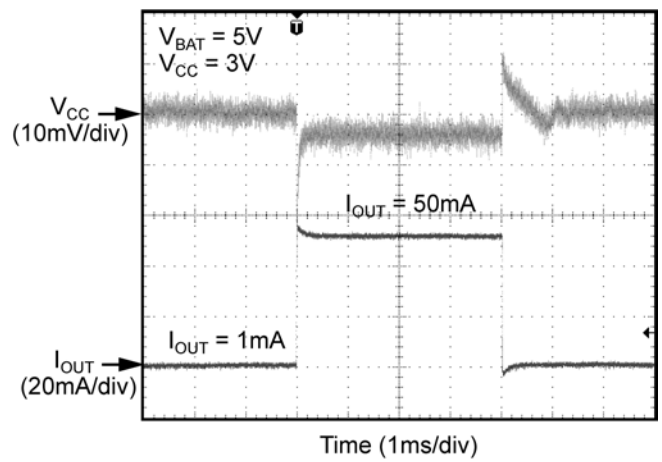

Line Transient DV_{CC} 3.1V to 5.5V

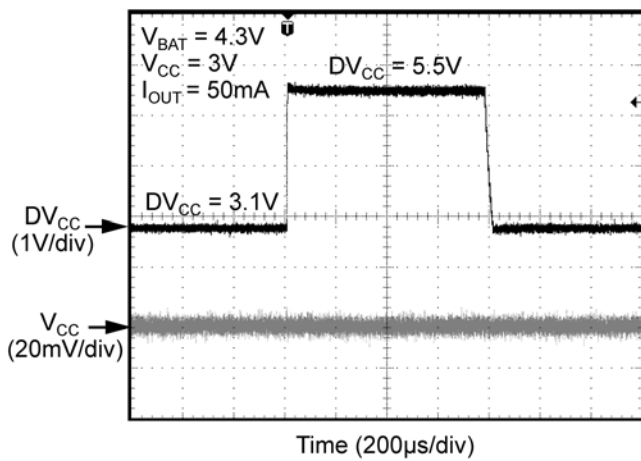

Line Transient V_{BAT} 3.1V to 5.5V

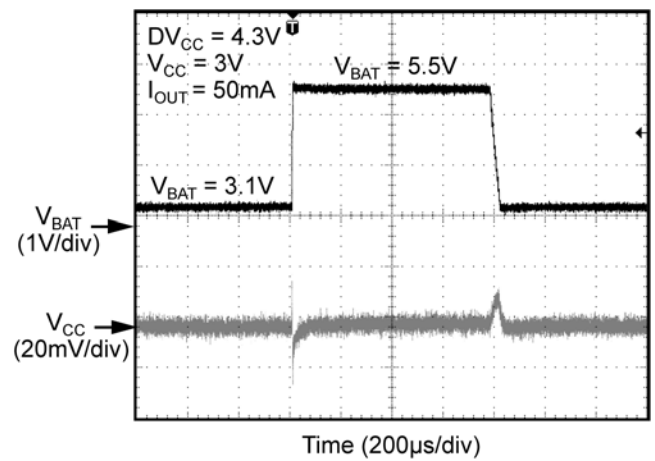

Functional Characteristics (Continued)

Start Up Waveform for LDO

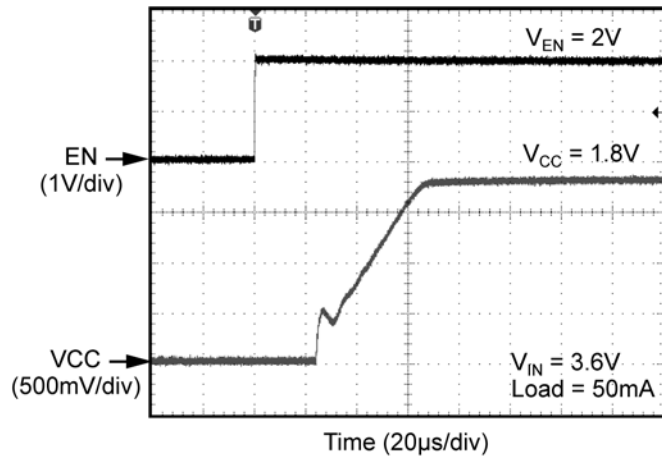

Short Circuit Recovery

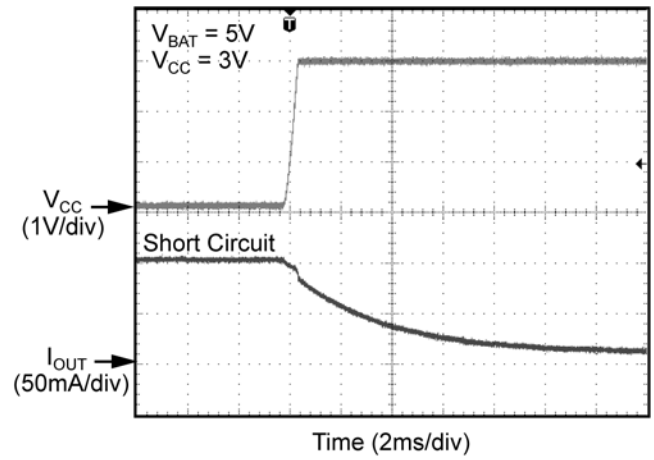

Functional Diagram

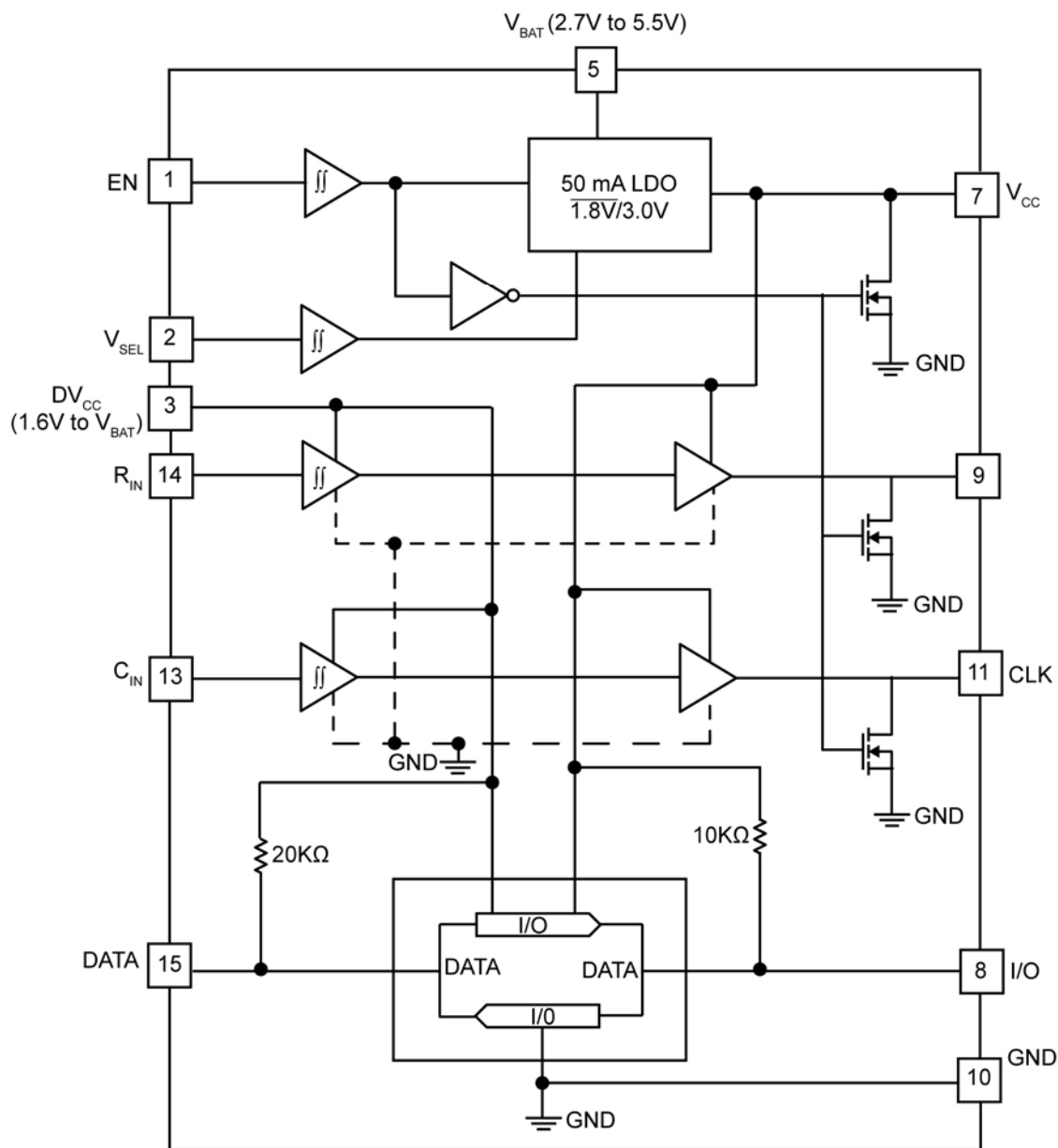

Figure 1. MIC4555 Functional Block Diagram

Functional Description

EN

The EN pin is the enable input from the controller. A logic high signal enables the level shifters and the V_{CC} output. A logic low signal disables the level shifters and the LDO and a low current shutdown mode is activated.

V_{SEL}

V_{SEL} selects the level shifted voltage for the SIM Card. A high logic voltage on V_{SEL} selects the level shifter to 3V. A low logic voltage on V_{SEL} selects the level shifter to 1.8V. Do not leave floating.

DV_{CC}

The DV_{CC} is the supply voltage for the controller side input and output pins (CIN, RIN, DATA). The operating range is from 1.6V to V_{BAT} . A minimum 1 μ F input capacitor with a minimum voltage rating of 6.3V placed close to DV_{CC} and ground (GND) is required. Refer to the *Layout Recommendations* for details.

V_{BAT}

The V_{BAT} is the input power supply to the LDO. The operating range is from 2.7V to 5.5V. A minimum 1 μ F input capacitor with a minimum voltage rating of 6.3V to ground (GND) is required. Refer to the *Layout Recommendations* for details.

V_{CC}

The V_{CC} is the output of the LDO and provides power to the SIM card. A minimum 1 μ F input capacitor with a minimum voltage rating of 6.3V to ground (GND) is required. Refer to the *Layout Recommendations* for details.

GND

The ground pin (GND) is the ground path for the biasing, the control circuitry and the power ground. The current loop for the ground should be kept as short as possible. Refer to the *Layout Recommendations* for more details.

RIN, RST

RIN is the digital reset input for the SIM Card and translates to RST through the digital level shifter. It is one directional. If V_{SEL} is low, then the input at RIN will be level shifted to 1.8V at the RST output. If V_{SEL} is high, then the input at RST will be level shifted to 3V at the RST output.

CIN, CLK

CIN is the digital input clock for SIM card. The CIN translates to CLK and is one directional. If V_{SEL} is low, then the input at CLKIN will be level shifted to 1.8V at the CLK output. If V_{SEL} is high, then the input at CIN will be level shifted to 3V at the CLK output.

DATA, I/O

DATA is the digital data for the SIM card. The DATA translate to I/O through the digital level shifter and is bidirectional using internal pull ups. If V_{SEL} is low, then the level shifted output is 1.8V at the I/O output. If V_{SEL} is high, then the level shifted output is 3V at the I/O output. Since DATA and I/O are bidirectional, the input at I/O is level shifted to equal the DV_{CC} voltage at the DATA output.

Application Information

The MIC4555 is a digital level shifter with a 50mA LDO for SIM card interfaces. There are three high-speed level shifters that can convert input voltages from the controller and then level shift it to either 1.8V or 3.0V for the SIM card. A voltage select pin (V_{SEL}) selects the output voltage. The MIC4555 also has a 50mA LDO that can be used to power the SIM card.

Input Capacitor

An input capacitor of 1 μ F is required from the V_{BAT} to ground to provide stability. Low-ESR ceramic capacitors provide optimal performance with minimum board area. Additional high-frequency capacitors, such as small valued NPO dielectric type capacitors, help filter out high-frequency noise and are good practice in any RF-based circuit. X5R or X7R dielectrics are recommended for the input capacitor. Y5V dielectrics lose most of their capacitance over temperature and are therefore, not recommended.

Output Capacitor

The MIC4555 requires an output capacitor of 1 μ F or greater for V_{CC} to maintain stability. The design is optimized for use with low-ESR ceramic-chip capacitors. High-ESR capacitors are not recommended because they may cause high-frequency oscillation. The output capacitor can be increased, but performance has been optimized for a 1 μ F ceramic output capacitor and does not improve significantly with larger capacitance.

X7R/X5R dielectric type ceramic capacitors are recommended because of their temperature performance. X7R-type capacitors change capacitance by 15% over their operating temperature range and are the most stable type of ceramic capacitors. Z5U and Y5V dielectric capacitors change value by as much as 50% and 60%, respectively, over their operating temperature ranges. To use a ceramic-chip capacitor with Y5V dielectric, the value must be much higher than an X7R ceramic capacitor to ensure the same minimum capacitance over the equivalent operating temperature range.

Thermal Considerations

The MIC4555 is designed to provide output current up to 50mA. The maximum ambient operating temperature can be calculated based upon the output current and the voltage drop across the part. For example if the input voltage (V_{BAT}) is 3.6V and the output voltage (V_{CC}) is 1.8V at 50mA, the power dissipation of the regulator circuit can be determined using the equation:

$$P_D = (V_{BAT} - V_{CC}) I_{OUT} + V_{BAT} I_{GND}$$

As the MIC4555 is a CMOS device, the ground current is typically <100 μ A over the load range, the power dissipation contributed by the ground current is < 1% and may be ignored for this particular calculation.

Example:

$$V_{BAT} = 3.6V$$

$$V_{CC} = 1.8V$$

$$I_{OUT} = 50mA$$

$$P_D = (3.6V - 1.8V)50mA$$

$$P_D = 0.09W$$

To determine the maximum operating ambient temperature of the package, use the junction to ambient thermal resistance of the device and the following basic equation:

$$P_{D(max)} = \left(\frac{T_{J(max)} - T_A}{\theta_{JA}} \right)$$

$T_{J(max)} = 125^\circ\text{C}$, the maximum junction temperature of the die, and θ_{JA} thermal resistance = 59 $^\circ\text{C/W}$ for the Thin MLF[®] package.

Substituting P_D for $P_{D(max)}$ and solving for the ambient operating temperature will give the maximum operating conditions for the regulator circuit.

The maximum power dissipation must not be exceeded for proper operation.

For example, when operating the MIC4555YMT at an input voltage of 3.6V and 50mA load with a minimum footprint layout, the maximum ambient operating temperature T_A can be determined as follows:

$$0.09W = (125^\circ\text{C} - T_A)/(59^\circ\text{C/W})$$

$$T_A = 119.69^\circ\text{C}$$

Therefore, the maximum ambient operating temperature of 119.69 $^\circ\text{C}$ is allowed in a 3mm x 3mm thin MLF[®] package. For a full discussion of heat sinking and thermal effects on voltage regulators, refer to the "Regulator Thermals" section of *Micrel's Designing with Low Dropout Voltage Regulators* handbook. This information can be found on Micrel's website at:

http://www.micrel.com/_PDF/other/LDOBk_ds.pdf

Typical Application Circuit

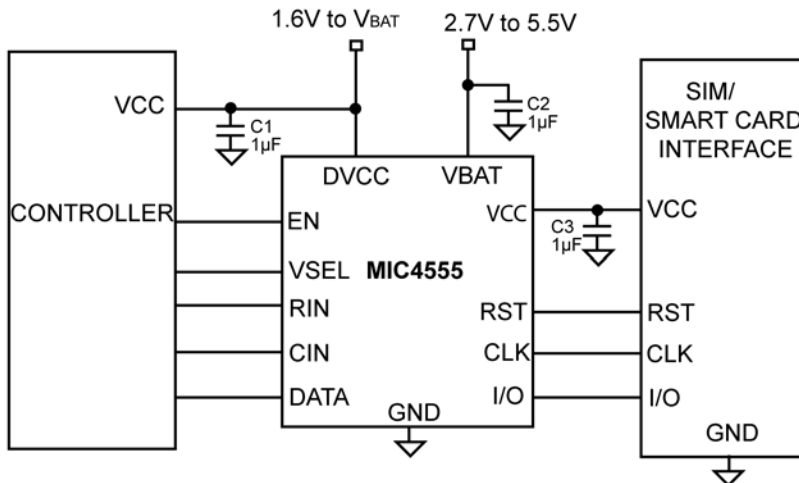

Bill of Materials

Item	Part Number	Manufacturer	Description	Qty.
C1, C2, C3	C1608X7R1H105K	TDK ⁽¹⁾	Ceramic Capacitor, 1µF, 6.3V, X7R, Size 0603	3
U1	MIC4555YML	Micrel, Inc. ⁽²⁾	SIM Card Level Shifter with 50mA LDO	1

Notes:

1. TDK: www.tdk.com.
2. Micrel, Inc.: www.micrel.com.

Layout Recommendations

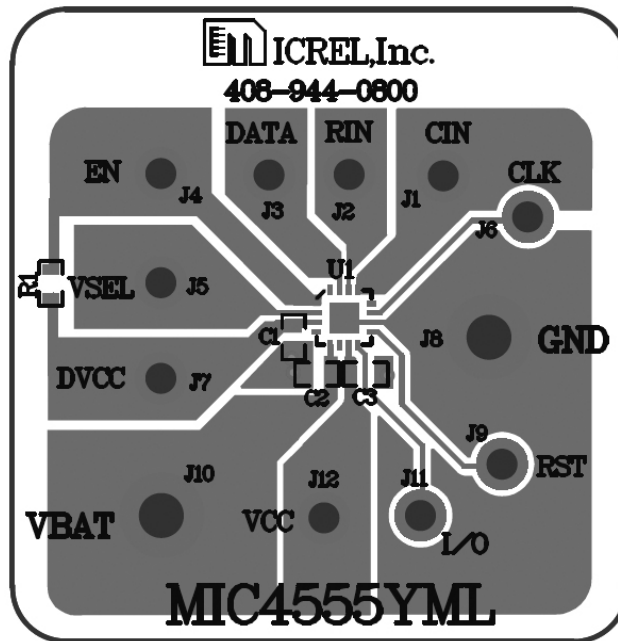

Top Layer

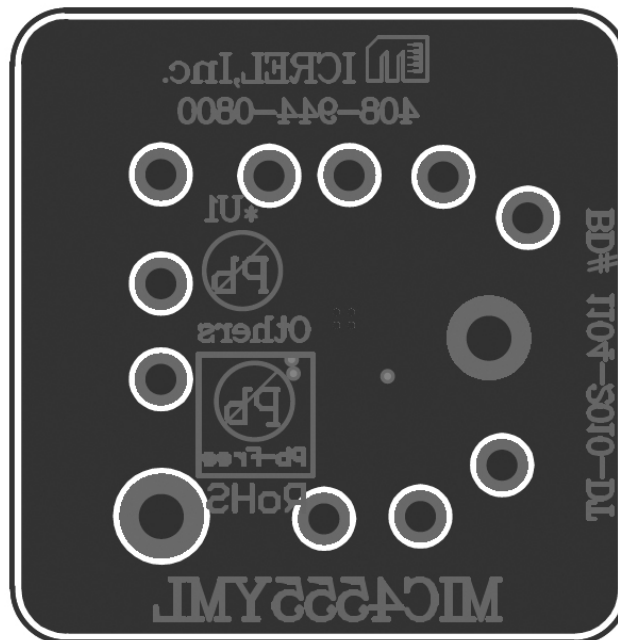

Bottom Layer

Package Information

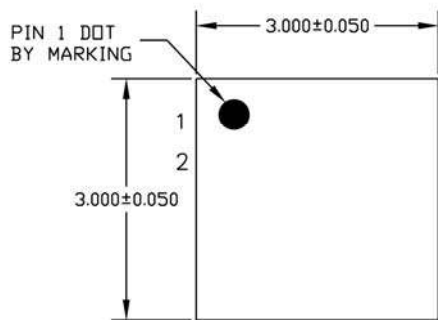

TOP VIEW

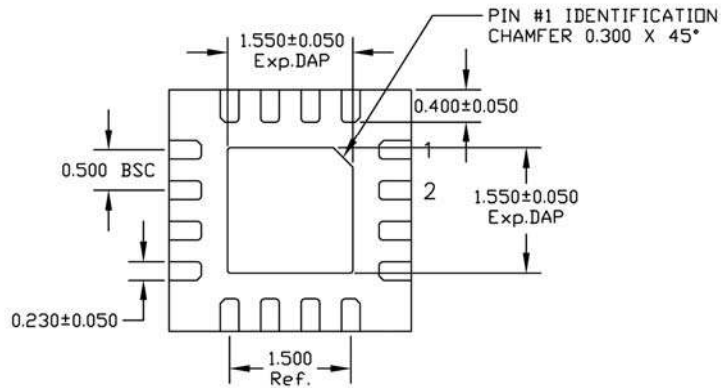

BOTTOM VIEW

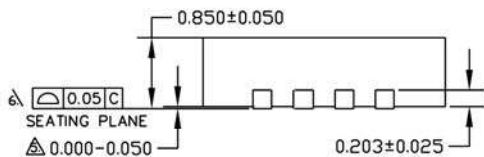

SIDE VIEW

16-Pin (3mm x 3mm) MLF® (ML)

MICREL, INC. 2180 FORTUNE DRIVE SAN JOSE, CA 95131 USA

TEL +1 (408) 944-0800 FAX +1 (408) 474-1000 WEB <http://www.micrel.com>

Micrel makes no representations or warranties with respect to the accuracy or completeness of the information furnished in this data sheet. This information is not intended as a warranty and Micrel does not assume responsibility for its use. Micrel reserves the right to change circuitry, specifications and descriptions at any time without notice. No license, whether express, implied, arising by estoppel or otherwise, to any intellectual property rights is granted by this document. Except as provided in Micrel's terms and conditions of sale for such products, Micrel assumes no liability whatsoever, and Micrel disclaims any express or implied warranty relating to the sale and/or use of Micrel products including liability or warranties relating to fitness for a particular purpose, merchantability, or infringement of any patent, copyright or other intellectual property right.

Micrel Products are not designed or authorized for use as components in life support appliances, devices or systems where malfunction of a product can reasonably be expected to result in personal injury. Life support devices or systems are devices or systems that (a) are intended for surgical implant into the body or (b) support or sustain life, and whose failure to perform can be reasonably expected to result in a significant injury to the user. A Purchaser's use or sale of Micrel Products for use in life support appliances, devices or systems is a Purchaser's own risk and Purchaser agrees to fully indemnify Micrel for any damages resulting from such use or sale.

© 2010 Micrel, Incorporated.