

# PMC Panel Mount Power Supply

## 24 V / 5 V 100 W Dual Output / PMC-DSPV100W1A

# PMC

### Highlights & Features

- Universal AC input voltage range
- Power will not de-rate for the entire input voltage range
- Full corrosion resistant aluminium casing
- Conforms to harmonics current IEC/EN 61000-3-2, Class A
- High MTBF > 700,000 hrs. per Telcordia SR-332
- Safety approval according to IEC/UL 60950-1, IEC/EN/UL 62368-1 and EMI to EN 55022, Class B

### Safety Standards



CB Certified for worldwide use

**Model Number:** PMC-DSPV100W1A  
**Unit Weight:** 0.52 kg (1.15 lb)  
**Dimensions (L x W x D):** 178 x 97 x 38 mm  
 (7.01 x 3.82 x 1.50 inch)



### General Description

Delta's PMC series of panel mount power supply offers dual output voltage 24 V & 5 V, a wide temperature range from -10°C to +70°C and a highly dependable minimum hold-up time. The state-of-the-art design is made to withstand harsh industrial environments. What makes the product stands out from the crowd is its lightweight full aluminum body design, which can withstand shock and vibration according to IEC60068-2. The PMC series also offers overvoltage and overload protection. Using a wide input voltage range design, it is compatible worldwide. The input also includes DC operating voltage from 125-375 Vdc. Best of all, this excellent design and quality does not come with a big price tag.

### Model Information

#### PMC Panel Mount Power Supply

Model Number	Input Voltage Range	Rated Output Voltage	Rated Output Current
PMC-DSPV100W1A	85-264 Vac (125-375 Vdc)	V1: 24 V V2: 5 V	V1: 2.7 A V2: 7.0 A

### Model Numbering

PMC –	D	SPV	100W	1	A
PMC Series	Dual O/P	S: 24 V Output Voltage P: 5 V Output Voltage V: Voltage	Output Power	Single Phase	Delta Standard

# PMC Panel Mount Power Supply

## 24 V / 5 V 100 W Dual Output / PMC-DSPV100W1A

### Specifications

#### Input Ratings / Characteristics

Nominal Input Voltage	100-240 Vac
Input Voltage Range	85-264 Vac
Nominal Input Frequency	50-60 Hz
Input Frequency Range	47-63 Hz
Nominal DC Input Voltage	125-250 Vdc
DC Input Voltage Range*	125-375 Vdc
Input Current	< 2.0 A @ 115 Vac, < 1.1 A @ 230 Vac
Efficiency at 100% Load	> 84% @ 115 Vac, > 86% @ 230 Vac
Max Power Dissipation	0% load < 2.0W @ 115Vac, < 2.5W @ 230Vac
	100% load < 19W @ 115Vac, < 16W @ 230Vac
Max Inrush Current (Cold Start)	< 50 A @ 115 Vac, < 100 A @ 230 Vac
Leakage Current	< 1 mA @ 240 Vac

\*Safety approval according to IEC/UL 60950-1 and IEC/EN/UL 62368-1.

#### Output Ratings / Characteristics\*\*

Nominal Output Voltage	V1: 24 Vdc, V2: 5 Vdc
Factory Set Point Tolerance	V1: 24 Vdc $\pm$ 2% V2: fixed
Output Voltage Adjustment Range	V1: 22.8-26.4 Vdc, V2: 5 V fixed
Output Current	V1: 2.7 A rated (0.3-4.0 A) V2: 7.0 A rated (0.8-7.0 A) (100 W max.)
Output Power***	100 W
Line Regulation	< 0.5% (@ 85-264 Vac input, 100% load)
Load Regulation	< 1.0% (@ 85-264 Vac input, V1: 100% rated load and V2: 60% rated load and vice versa)
PARD**** (20 MHz)	V1: <200 mVpp V2: <80 mVpp
Rise Time	V1: <30 ms V2: <20 ms nominal input (100% load)
Start-up Time	< 1000 ms @ nominal input (100% load)
Hold-up Time	> 15 ms @ 115 Vac, > 80 ms @ 230 Vac (100% load)
Dynamic Response (Overshoot & Undershoot O/P Voltage)	$\pm$ 5% @ V1: 0-100% rated load and V2: 60% rated load and vice versa (Slew Rate: 0.1A/ $\mu$ s, 50% duty cycle @ 5Hz to 1KHz)
Start-up with Capacitive Loads	V1: 4,000 $\mu$ F Max

\*\*For power de-rating from 50°C to 70°C, see power de-rating on page 3.

\*\*\*Combination of output power at V1 + V2 shall keep within 100 W. For example: V1: 24 V/4 A (96 W), V2: 5 V/0.8 A (4 W) or V1: 24 V/2.7 A (65 W), V2: 5 V/7 A (35 W).

\*\*\*\*PARD is measured with an AC coupling mode, and in parallel with 0.1  $\mu$ F ceramic capacitor & 47  $\mu$ F electrolytic capacitor.

# PMC Panel Mount Power Supply

## 24 V / 5 V 100 W Dual Output / PMC-DSPV100W1A

### Mechanical

Case Cover	Aluminium
Dimensions (L x W x D)	178 x 97 x 38 mm (7.01 x 3.82 x 1.50 inch)
Unit Weight	0.52 kg (1.15 lb)
Indicator	Green LED DC OK
Cooling System	Convection
Terminal	Input and Output M3.5 x 7 Pins (Rated 300 V/15 A)
Wire	AWG 20-14
Noise (1 Meter from power supply)	Sound Pressure Level (SPL) <40 dBA

### Environment

Surrounding Air Temperature	Operating	-10°C to +70°C
	Storage	-25°C to +85°C
Power De-rating		> 50°C de-rate power by 2.5% / °C
Operating Humidity		5 to 95% RH (Non-Condensing)
Operating Altitude		0 to 3,000 Meters (9,840 ft.)
Shock Test	Non-Operating	IEC60068-2-27, 30 G (300m/S <sup>2</sup> ) for a duration of 18ms 3 times per direction, 18 times in total
Vibration	Non-Operating	IEC60068-2-6, 10 Hz to 150 Hz @ 50 m/S <sup>2</sup> (5G peak); 20 min per axis for all X, Y, Z direction
Over Voltage Category		II
Pollution Degree		2

### Protections

Overvoltage	V1: < 32.4 V, V2: 6.75 V, Hiccup Mode, Non-Latching (Auto recovery).
Overload / Overcurrent	OLP: > 150% of total rated output power, Hiccup Mode, Non-Latching (Auto recovery). OCP: Hiccup Mode, Non-Latching (Auto recovery) <ul style="list-style-type: none"> <li>V1: 3-6 A, V2: rated current, protect both V1&amp;V2</li> <li>V2: 8-12 A, V1: rated current, protect only V2 and V1 still remain</li> </ul>
Over Temperature	< 75°C Surrounding Air Temperature @ 100% load, Non-Latching (Auto-recovery).
Short Circuit	Hiccup Mode, Non-Latching (Auto-recovery when the fault is removed)
Internal Fuse at L pin	T3.15AH
Protection Against Shock	Class I with PE* connection

\*PE: Primary Earth

### Reliability Data

MTBF	> 700,000 hrs. as per Telcordia SR-332 I/P: 115 Vac, O/P: 100% load, Ta: 25°C
Expected Cap Life Time	10 years (115 Vac & 230 Vac, 50% load @ 40°C)

# PMC Panel Mount Power Supply

## 24 V / 5 V 100 W Dual Output / PMC-DSPV100W1A

### Safety Standards / Directives

Safety Entry Low Voltage		SELV (EN 60950-1)
Electrical Safety	TUV Bauart	EN 62368-1
	UL/cUL recognized	UL 60950-1 and CSA C22.2 No. 60950-1 (File No. E191395), UL 62368-1 and CSA C22.2 No. 62368-1 (File No. E191395)
	CB scheme	IEC 60950-1, IEC 62368-1
	UKCA	BS EN 62368-1
CCC		GB/T9254, GB17625.1 and GB4943.1 仅适用于海拔 2000m 以下地区安全使用
CE		In conformance with EMC Directive 2014/30/EU and Low Voltage Directive 2014/35/EU
UKCA		In conformance with Electrical Equipment (Safety) Regulations 2016 No. 1011 and The Electromagnetic Compatibility Regulations 2016 No. 1091
Galvanic Isolation	Input to Output	3.0 KVac
	Input to Ground	1.5 KVac
	Output to Ground	0.5 KVac

### EMC

Emissions (CE & RE)		Generic Standards: CISPR32, EN/BS EN 55032, FCC Title 47: Class B, GB 9254
Immunity		Generic Standards: EN/BS EN 55024
Electrostatic Discharge	IEC61000-4-2	Level 4 Criteria A <sup>1)</sup> Air Discharge: 15 kV Contact Discharge: 8 kV
Radiated Field	IEC61000-4-3	Level 2 Criteria A <sup>1)</sup> 80 MHz-1 GHz, 3 V/M with 1 kHz tone / 80% modulation
Electrical Fast Transient / Burst	IEC61000-4-4	Level 3 Criteria A <sup>1)</sup> 2 kV
Surge	IEC61000-4-5	Level 3 Criteria A <sup>1)</sup> Common Mode <sup>2)</sup> : 2 kV Differential Mode <sup>3)</sup> : 2 kV
Conducted	IEC61000-4-6	Level 2 Criteria A <sup>1)</sup> 150 kHz-80 MHz, 3 Vrms
Power Frequency Magnetic Fields	IEC61000-4-8	Criteria A <sup>1)</sup> 1 A/Meter
Voltage Dips and Interruptions	IEC61000-4-11	100% dip; 1 cycle (20 ms); Self Recoverable
Low Energy Pulse Test (Ring Wave)	IEC61000-4-12	Level 3 Criteria A <sup>1)</sup> Common Mode <sup>2)</sup> : 2 kV Differential Mode <sup>3)</sup> : 1 kV
Harmonic Current Emission		IEC/EN/BS EN 61000-3-2, Class A
Voltage Fluctuation and Flicker		IEC/EN/BS EN 61000-3-3

1) Criteria A: Normal performance within the specification limits

2) Asymmetrical: Common mode (Line to earth)

3) Symmetrical: Differential mode (Line to line)

# PMC Panel Mount Power Supply

## 24 V / 5 V 100 W Dual Output / PMC-DSPV100W1A

### Block Diagram

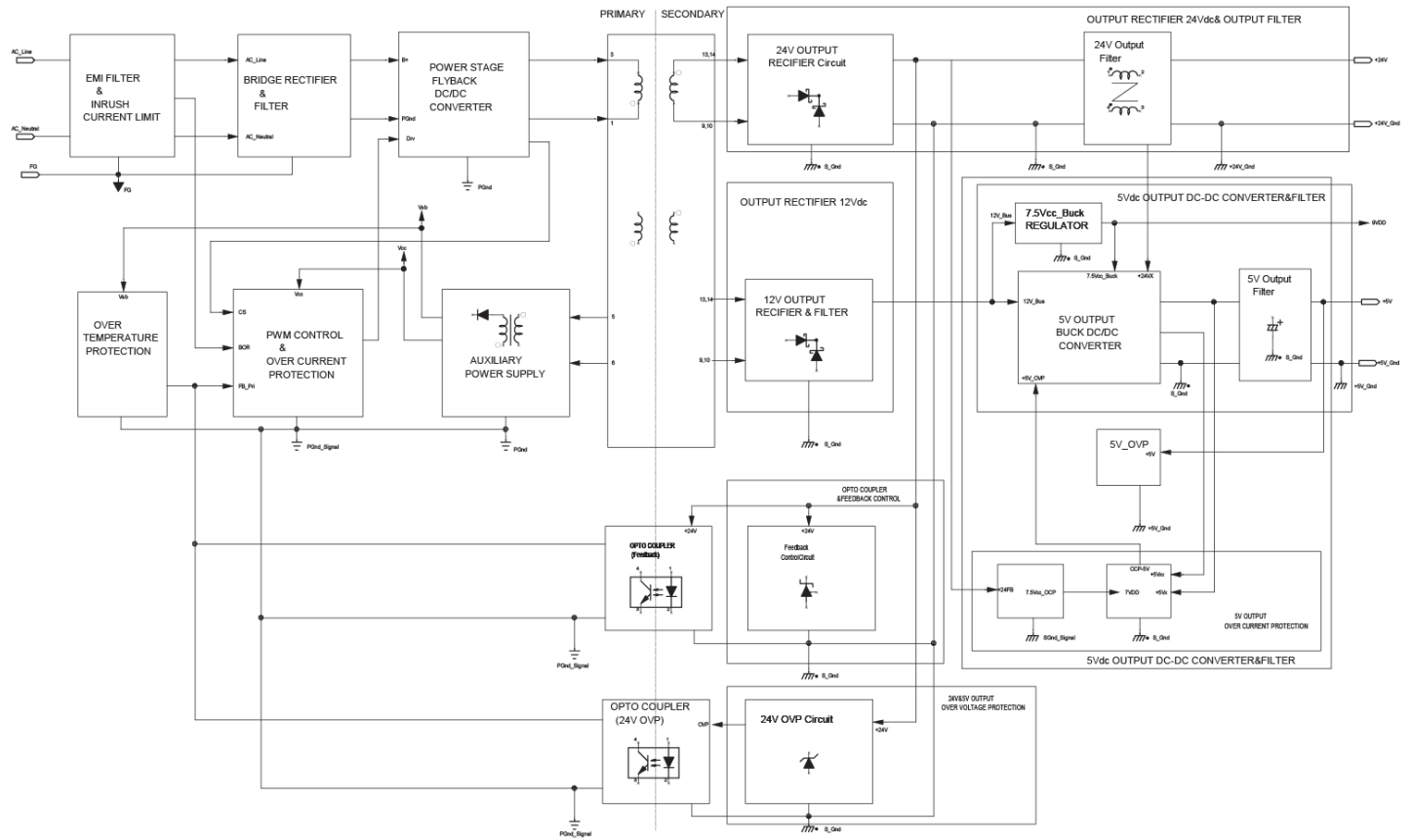

### Device Description

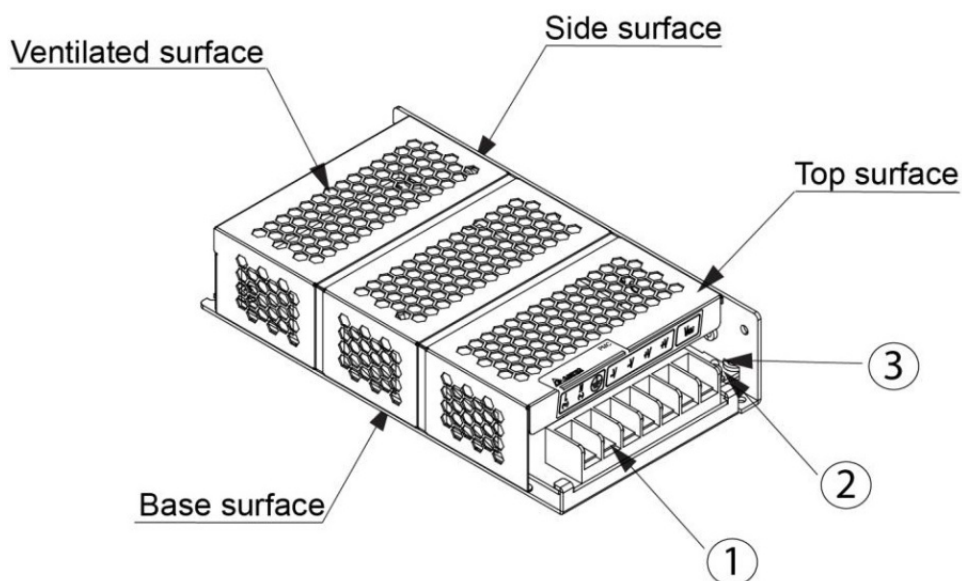

- 1) Input & Output terminal block connector
- 2) DC Voltage adjustment potentiometer of V1: 24 V
- 3) DC OK control LED (Green) of V1: 24 V

# PMC Panel Mount Power Supply

## 24 V / 5 V 100 W Dual Output / PMC-DSPV100W1A

### Dimensions

L x W x H: 178 x 97 x 38 mm (7.01 x 3.82 x 1.50 inch)

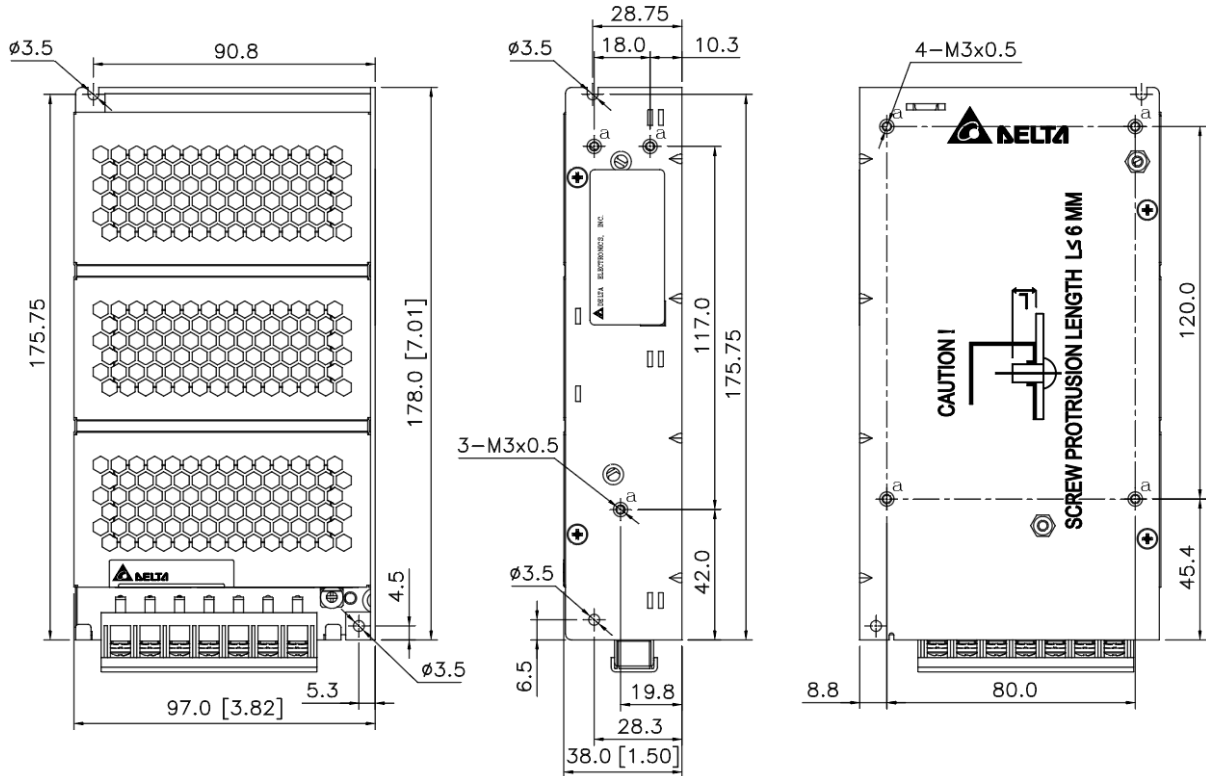

### Engineering Data

#### Output Load De-rating VS Surrounding Air Temperature

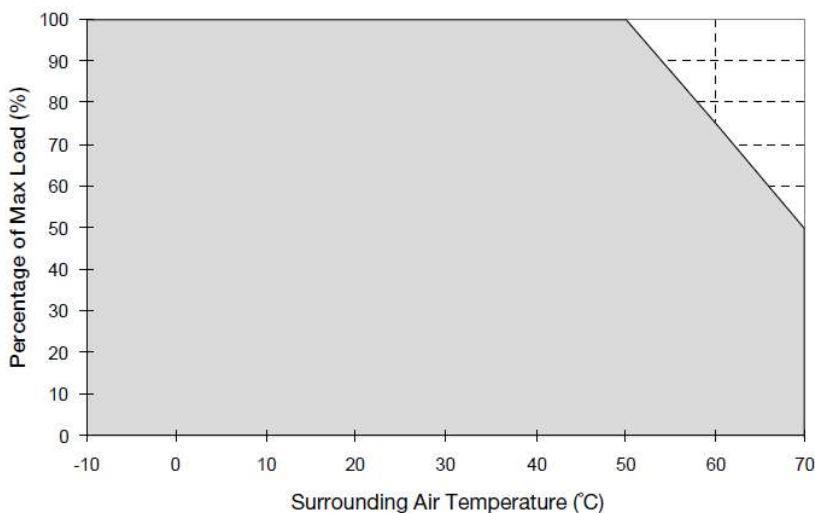

**Fig. 1 De-rating for Vertical and Horizontal Mounting Orientation**  
 > 50°C de-rate power by 2.5% / °C

#### Note

1. Power supply components may degrade, or be damaged, when the power supply is continuously used outside the shaded region, refer to the graph shown in Fig. 1.
2. If the output capacity is not reduced when the surrounding air temperature exceeds its specification as defined on Page 3 under "Environment", the device may run into Over Temperature Protection. When activated, the output voltage will go into bouncing mode and will recover when the surrounding air temperature is lowered or the load is reduced as far as necessary to keep the device in working condition.
3. In order for the device to function in the manner intended, it is also necessary to keep a safety distance as recommended in the safety instructions while the device is in operation.
4. Depending on the surrounding air temperature and output load delivered by the power supply, the device housing can be very hot!
5. If the device has to be mounted in any other orientation, please contact [info@deltapsu.com](mailto:info@deltapsu.com) for more details.

# PMC Panel Mount Power Supply

## 24 V / 5 V 100 W Dual Output / PMC-DSPV100W1A

### Output Load De-rating VS Input Voltage

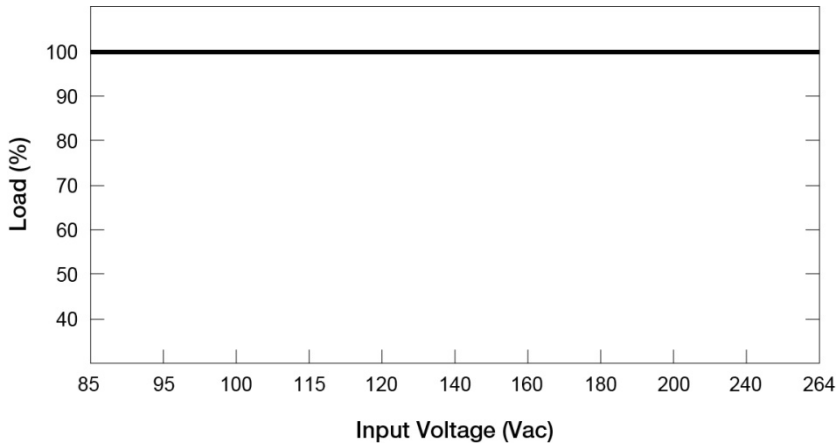

■ No output power de-rating across the entire input voltage range

### Assembly & Installation

- Ⓐ Mounting holes for power supply assembly onto the mounting surface. Power supply shall be mounted on minimum 2 mounting holes using M3 screw minimum 5 mm (0.20 inch) length.
- Ⓑ This surface belongs to customer's end system or panel where the power supply is mounted.
- Ⓒ Connector.

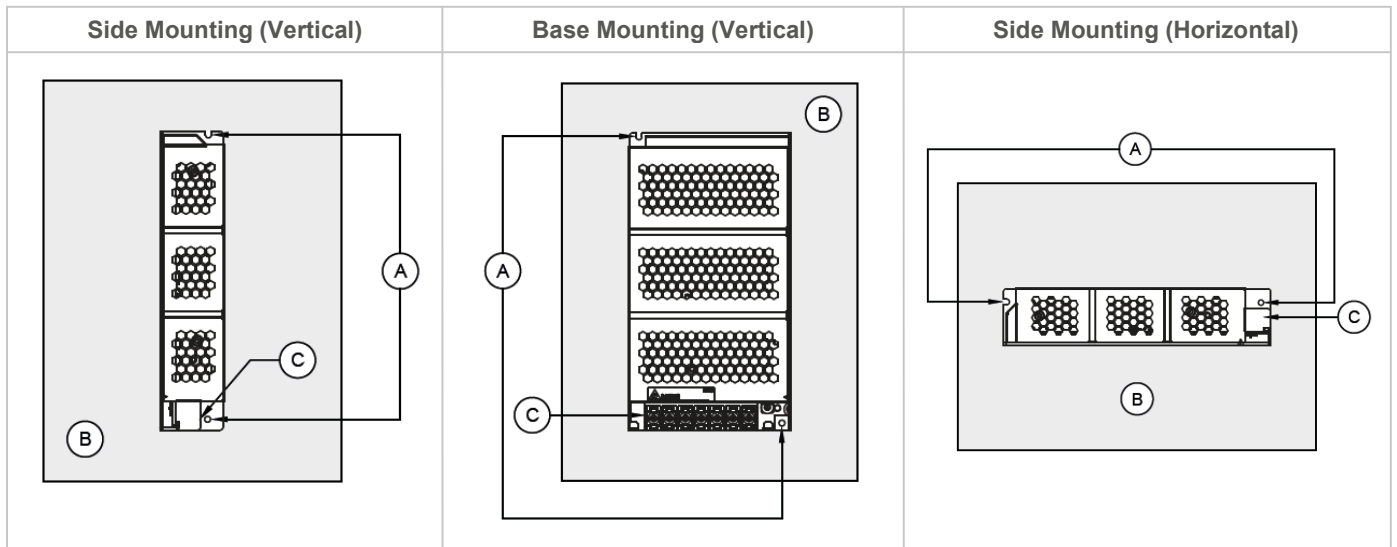

Fig. 2 Mounting Orientation

- Use flexible cable (stranded or solid) of AWG 20-14.
- The torque at the Connector shall not exceed 13 Kgf.cm. (11.23 lb.in). The insulation stripping length should not exceed 0.275" or 7 mm.

# PMC Panel Mount Power Supply

## 24 V / 5 V 100 W Dual Output / PMC-DSPV100W1A

### Installation of Mounting Accessories

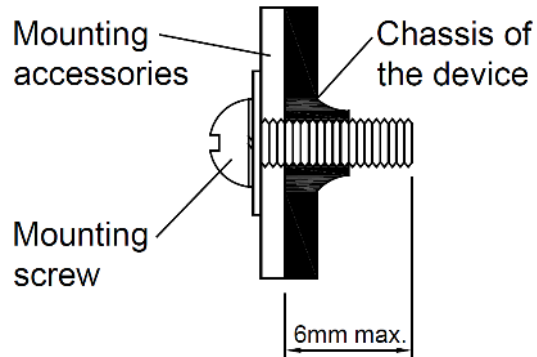

- Only use M3 screw  $\leq 6$  mm (0.24 inch) through the base mounting holes. This is to keep a safe distance between the screw and internal components.
- Recommended mounting tightening torque: 4~8 Kgf.cm. (3.47~6.94 lbf.in).

### Safety Instructions

- To ensure sufficient convection cooling, always maintain a safety distance of  $>20$  mm (0.79 inch) from all ventilated surfaces while the device is in operation.
- The device is not recommended to be placed on low thermal conductive surface, for example, plastics.
- Note that the enclosure of the device can become very hot depending on the ambient temperature and load of the power supply. Do not touch the device while it is in operation or immediately after power is turned OFF. Risk of burning!
- Do not touch the terminals while power is being supplied. Risk of electric shock.
- Prevent any foreign metal, particles or conductors to enter the device through the openings during installation. It can cause: Electric shock; Safety Hazard; Fire; Product failure
- Warning: When connecting the device, secure Earth connection before connecting L and N. When disconnecting the device, remove L and N connections before removing the Earth connection.



# PMC Panel Mount Power Supply

## 24 V / 5 V 100 W Dual Output / PMC-DSPV100W1A

### Functions

■ Graph illustrating the Start-up Time, Rise Time, and Hold-up Time

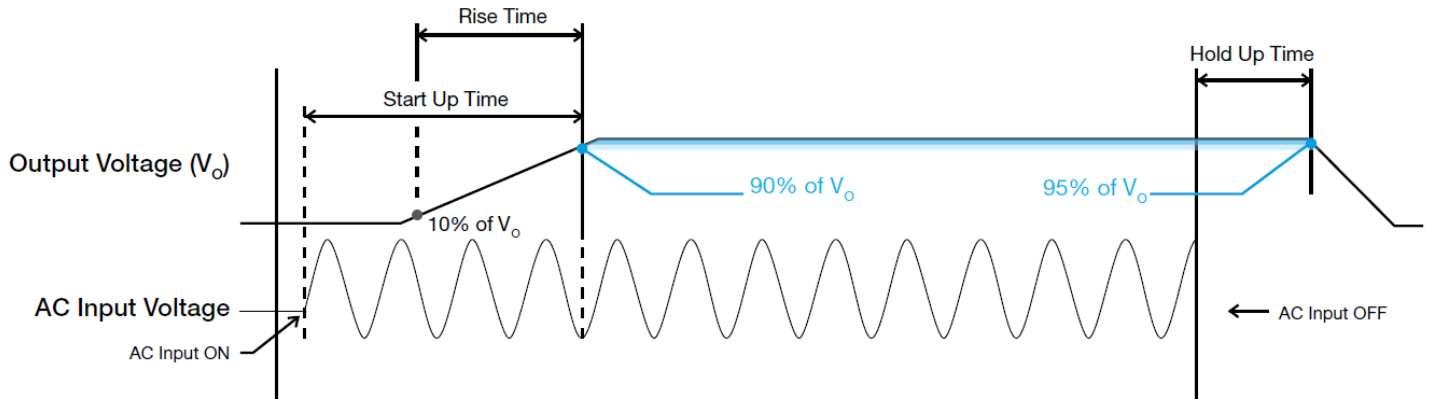

### Start-up Time

The time required for the output voltage to reach 90% of its final steady state set value, after the input voltage is applied.

### Rise Time

The time required for the output voltage to change from 10% to 90% of its final steady state set value.

### Hold-up Time

Time between the collapse of the AC input voltage, and the output falling to 95% of its steady state set value.

### Inrush Current

Inrush current is the peak, instantaneous, input current measured and, occurs when the input voltage is first applied. For AC input voltages, the maximum peak value of inrush current will occur during the first half cycle of the applied AC voltage. This peak value decreases exponentially during subsequent cycles of AC voltage.

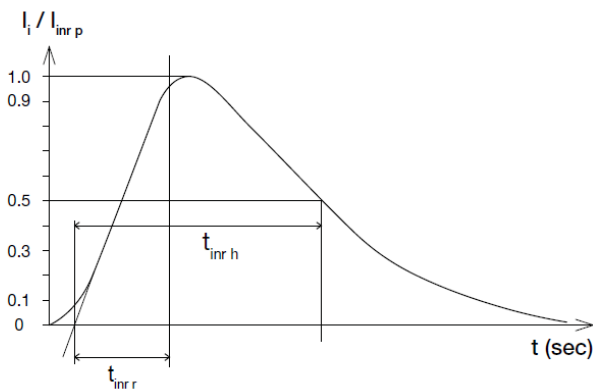

### Dynamic Response

The power supply output voltage will remain within  $\pm 5\%$  of its steady state value, when subjected to a dynamic load from 0 to 100% of its rated current.

■ 50% duty cycle / 5Hz to 1KHz

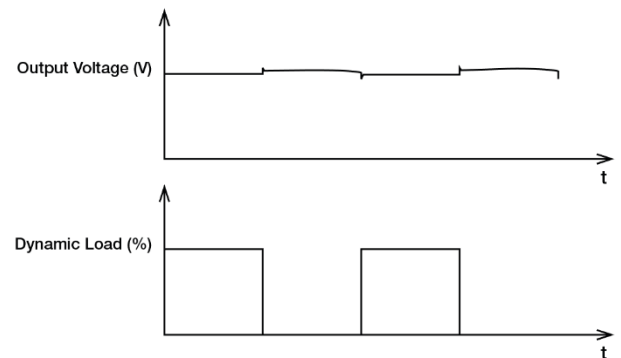

# PMC Panel Mount Power Supply

## 24 V / 5 V 100 W Dual Output / PMC-DSPV100W1A

### Overload & Overcurrent Protections (Auto-Recovery)

The power supply's Overload (OLP) and Overcurrent (OCP) Protections will be activated when output current ( $I_o$ ) exceeds its specification as defined on Page 3 under "Protections". In such occurrence, the output voltage ( $V_o$ ) will start to droop and once the power supply has reached its maximum power limit, the protection is activated and the power supply will go into "Hiccup mode" (Auto-Recovery). The power supply will recover once the fault condition of the OLP and OCP is removed and  $I_o$  is back within the specifications.

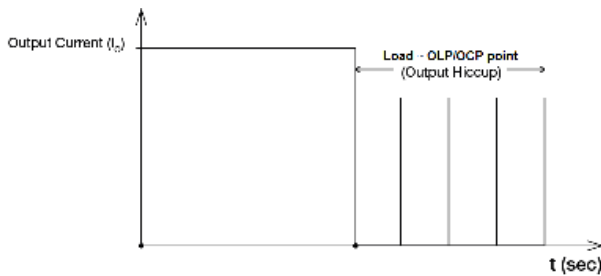

It is not recommended to prolong the duration of  $I_o$  when it is less than OLP/OCP point, but greater than 100%, since it may cause damage to the PSU.

### Short Circuit Protection (Auto-Recovery)

The power supply's output OLP/OCP function also provides protection against short circuits. When a short circuit is applied, the output current will operate in "Hiccup mode", as shown in the illustration in the OLP/OCP section on this page. The power supply will return to normal operation after the short circuit is removed.

### Overvoltage Protection (Auto-Recovery)

The power supply's overvoltage circuit will be activated when its internal feedback circuit fails. The output voltage shall not exceed its specifications defined on Page 3 under "Protections".

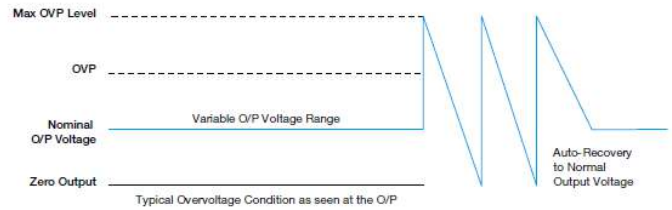

### Over Temperature Protection (Auto-Recovery)

As mentioned above, the power supply also has Over Temperature Protection (OTP). In the event of a higher operating temperature at 100% load, the power supply will run into OTP when the operating temperature is beyond what is recommended in the de-rating graph. When activated, the output voltage will go into bouncing mode until the temperature drops to its normal operating temperature as recommended in the de-rating graph.

# PMC Panel Mount Power Supply

## 24 V / 5 V 100 W Dual Output / PMC-DSPV100W1A

### Others

#### PFC – Norm EN 61000-3-2

##### Line Current harmonic



Typically, the input current waveform is not sinusoidal due to the periodical peak charging of the input capacitor. In industrial environment, complying with EN 61000-3-2 is only necessary under special conditions. Complying to this standard can have some technical drawbacks, such as lower efficiency as well as some commercial aspects such as higher purchasing costs. Frequently, the user does not profit from fulfilling this standard, therefore, it is important to know whether it is mandatory to meet this standard for a specific application.

This product conforms to this standard.

### Attention

Delta provides all information in the datasheets on an “AS IS” basis and does not offer any kind of warranty through the information for using the product. In the event of any discrepancy between the information in the catalog and datasheets, the datasheets shall prevail (please refer to [www.DeltaPSU.com](http://www.DeltaPSU.com) for the latest datasheets information). Delta shall have no liability of indemnification for any claim or action arising from any error for the provided information in the datasheets. Customer shall take its responsibility for evaluation of using the product before placing an order with Delta.

Delta reserves the right to make changes to the information described in the datasheets without notice.

### Manufacturer and Authorized Representatives Information

#### Manufacturer

##### Thailand

Delta Electronics (Thailand) PCL.  
909 Pattana 1 Rd., Muang, Samutprakarn, 10280 Thailand

##### Taiwan

Delta Electronics, Inc.  
3 Tungyuan Road, Chungli Industrial Zone, Taoyuan County  
32063, Taiwan

#### Authorized Representatives

##### The Netherlands

Delta Greentech (Netherlands) B.V.  
Zandsteen 15, 2132 MZ Hoofddorp, The Netherlands

##### United Kingdom

Delta Electronics Europe Limited  
1 Redwood Court, Peel Park Campus,  
East Kilbride, Glasgow, G74 5PF, United Kingdom