

$I_V = 300 \text{ mcd}$, $V_F = 3.3 \text{ V}$
Through-hole LED
SELG5D20C-SD

Description

The SELG5D20C-SD is a through-hole pure green LED. The product includes a protection diode for ESD protection.

Features

- Color-----Pure Green
- Lens Color ----- Clear
- Luminous Intensity, I_V ---300 mcd (typ.) ($I_F = 20 \text{ mA}$)
- Forward Voltage, V_F ----- 3.3 V (typ.) ($I_F = 20 \text{ mA}$)
- Dominant Wavelength, λ_D ----- 525 nm
- Viewing Angle, $2\theta_{1/2}$ ----- 140 deg
- RoHS Compliant
- Pb-free, Soldering
- High Reliability

Applications

- Switch
- Indicator
- Illumination

Package

5 mm Pitch Lead Square Type
(No LED-to-PCB clearance required)

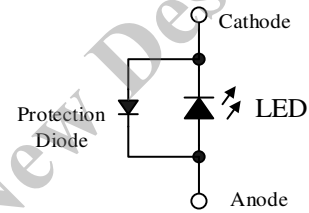

Not to scale

Not Recommended for New Designs

SELG5D20C-SD

Absolute Maximum Ratings

Unless specifically noted, $T_A = 25\text{ }^\circ\text{C}$.

Parameter	Symbol	Conditions	Rating	Unit
Power Dissipation	P_D		75	mW
Forward Current	I_F		30	mA
Forward Current Reduction	ΔI_F	$T_A \geq 60\text{ }^\circ\text{C}$	-0.45	mA/ $^\circ\text{C}$
Pulse Forward Current	I_{FP}	Frequency = 1 kHz Pulse Width $\leq 100\text{ }\mu\text{s}$	100	mA
Reverse Current	I_R		1	mA
Operating Temperature	T_{OP}		-30 to 85	$^\circ\text{C}$
Storage Temperature	T_{STG}		-30 to 100	$^\circ\text{C}$

Electrical / Optical Characteristics

Unless specifically noted, $T_A = 25\text{ }^\circ\text{C}$.

Parameter	Symbol	Conditions	Min.	Typ.	Max.	Unit
Forward Voltage	V_F	$I_F = 20\text{ mA}$	—	3.3	3.7	V
Reverse Voltage	V_R	$I_R = 1\text{ mA}$	—	0.8	—	V
Luminous Intensity	I_V	$I_F = 20\text{ mA}$	197	300	—	mcd
Dominant Wavelength	λ_D	$I_F = 20\text{ mA}$	520	525	530	nm
Viewing Angle	$2\theta_{1/2}$	$I_F = 20\text{ mA}$	—	140	—	deg

Luminous Intensity Bins

Bin Number	Luminous Intensity Range	Unit
C	197 to 394	mcd
D	263 to 526	mcd
E	350 or more	mcd

Wavelength Bins

The values have a tolerance of $\pm 2\text{ nm}$.

Bin Number	Wavelength Range	Unit
G	520 to 525	nm
Y	525 to 530	nm

Derating Curves

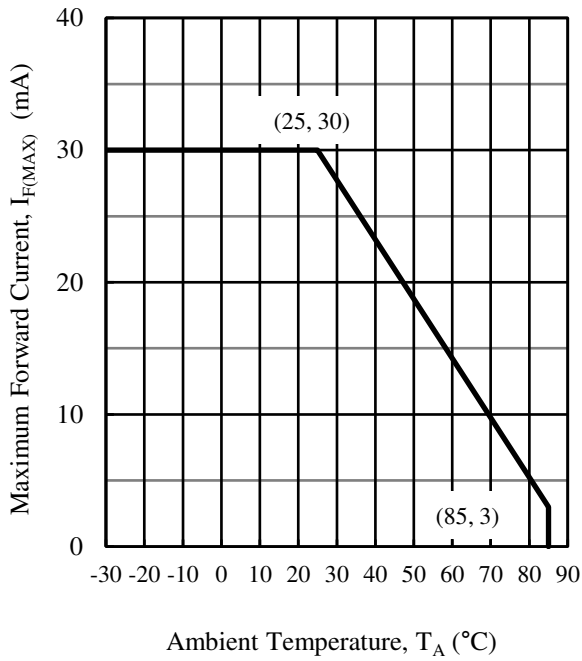

Figure 1. $I_{F(MAX)}$ vs. T_A

Performance Curves

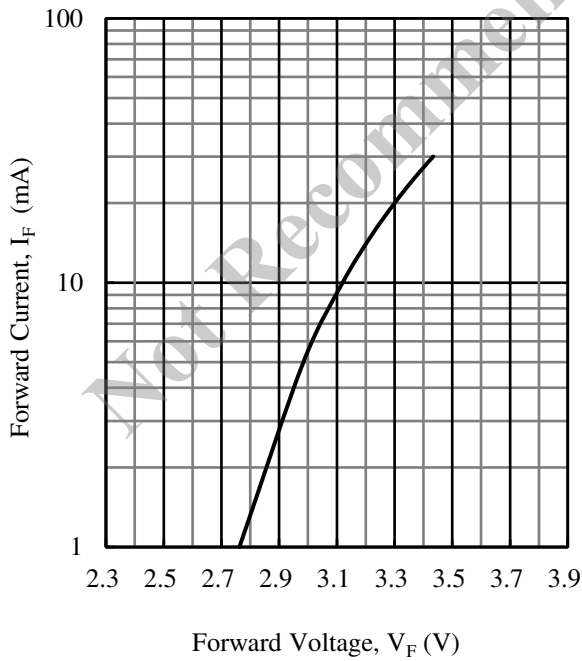

Figure 2. I_F vs. V_F

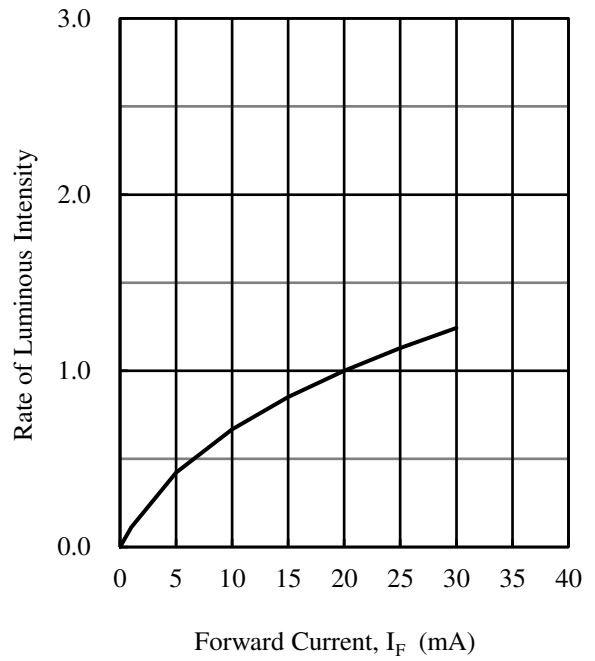

Figure 3. Rate of Luminous Intensity vs. I_F

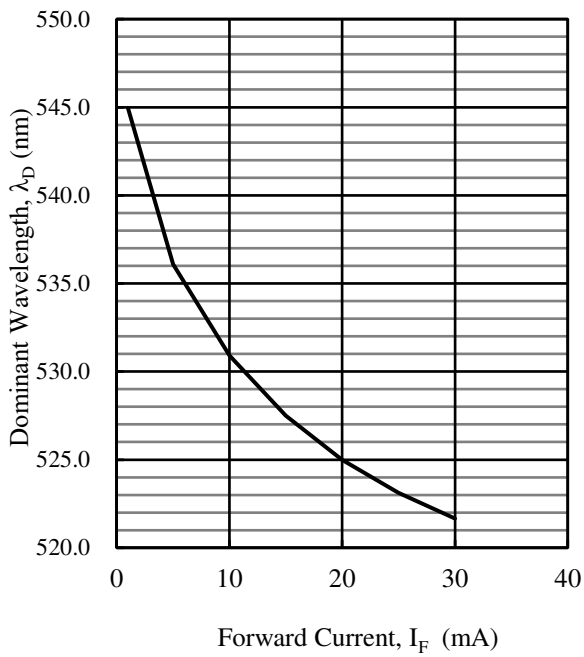

Figure 4. λ_D vs. I_F

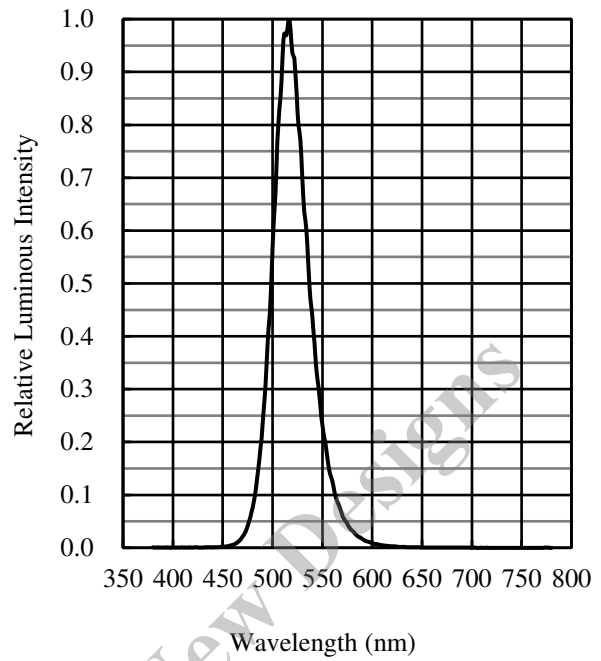

Figure 5. Spectrum

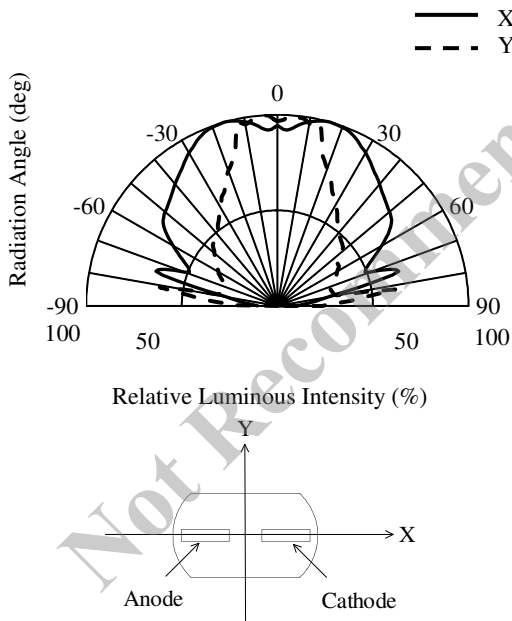
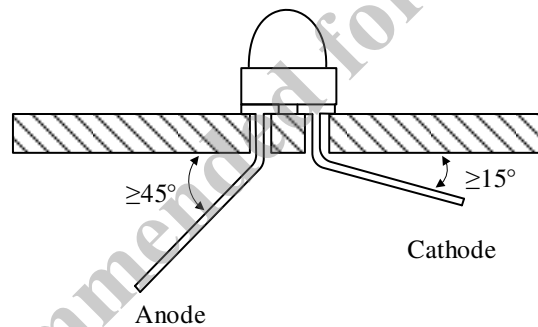

Figure 6. Directivity

Soldering Conditions

- When soldering the products, it is required to minimize the working time within the following limits:
 - Flow:
 - Preheat: 90 °C / 120 s
 - Solder heating: 250 °C / 3 s
 - Soldering iron: 350 ± 10 °C / 3 s, 1 timeBe sure to ensure a distance of ≥ 1.6 mm between the encapsulating resin and the solder.
- The following are the considerations in fixing the chip parts to be mounted on the same board as the product. When fixing such chip parts with an adhesive before soldering, extreme care should be taken not to heat the product before the adhesive is firmly cured (e.g., while it is being cured). Firstly, fix the chip parts other than the products with an adhesive. Secondly, heat to cure the adhesive before mounting the product. Finally, mount and solder the product. If there is no choice but to simultaneously heat the product and other chip parts for curing the adhesive, perform the simultaneous heating under the conditions listed below without any external force, stress, or excessive vibration applied to the product. After the adhesive is cured, cool the product to a room temperature and then perform soldering.
 - Solder heating temperature: ≤ 120 °C
 - Solder heating time: ≤ 60 s
- A hole pitch to be formed on a board should be identical to the pin pitch of the product.
- When mounting the product on a double-sided board, do not use plated through holes.
- When mounting the product with an automatic insertion machine, care should be taken not to apply excessive stress. Also, when clinching the pins to prevent the product from coming off, secure each of the angles shown in the figure below. Otherwise, an internal wire of the LED may break or the resin may be damaged.



Precautions for Use

• Measures for Electrostatic Discharge (ESD)

Generally, InGaN-based elements such as blue LEDs are very sensitive to ESD. For enhanced ESD withstand capability, this product is designed to include a surge protection diode as shown in the figure below. Therefore, the following ESD withstand capabilities are ensured: ≥ 200 V on machine model ($C = 200$ pF, $R = 0 \Omega$), and ≥ 2000 V on human body model ($C = 100$ pF, $R = 1.5$ k Ω). Note that, however, all the values mentioned above are not guaranteed.

When using the product, care should be taken not to apply a voltage in the opposite direction of the LED. If a voltage is applied in the opposite direction of the LED, the surge protection diode becomes conductive, and then an unintended current may flow through the set.

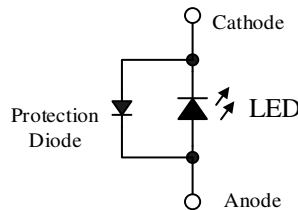

• Other

- After soldering the product, care should be taken not to apply mechanical stress or excessive vibration until it cools to room temperature. A glass transition of the product's encapsulating resin will occur at temperatures from about 120 °C to 130 °C. When the resin temperature exceeds these temperatures, the resin softens rapidly. Therefore, applying stress or excessive vibration to the resin or pin at high temperatures may cause a shift in the pin alignment or a wire breakage.
- Do not cool the product rapidly.
- When mounting the product on a board, mounting position and orientation should be taken into account so that any stress due to board warpage is not applied to the product.
- Do not touch the encapsulating resin of the product with sharp objects such as a tweezer or fingernails. Also, do not use the product again after removal.
- Do not touch the product after mounting it on a board.
- The product emits a high-power light. Therefore, care should be taken not to look at the light emission directly for a long time because it may hurt your eyes.
- Use the product at rated current (sorting current) as much as possible. When the product is used at a current lower than the rated current (sorting current), a variation in forward voltage or luminous intensity may increase. Therefore, care should be taken for such variation when you use the product at low current.
- When the product is used in applications where high-and-low current regulations are repeated for a long time, its luminous intensity lifetime may be shortened in low-current settings. Therefore, thorough verifications are required beforehand.

Important Notes

- All data, illustrations, graphs, tables and any other information included in this document (the “Information”) as to Sanken’s products listed herein (the “Sanken Products”) are current as of the date this document is issued. The Information is subject to any change without notice due to improvement of the Sanken Products, etc. Please make sure to confirm with a Sanken sales representative that the contents set forth in this document reflect the latest revisions before use.
- The Sanken Products are intended for use as components of general purpose electronic equipment or apparatus (such as home appliances, office equipment, telecommunication equipment, measuring equipment, etc.). Prior to use of the Sanken Products, please put your signature, or affix your name and seal, on the specification documents of the Sanken Products and return them to Sanken. When considering use of the Sanken Products for any applications that require higher reliability (such as transportation equipment and its control systems, traffic signal control systems or equipment, disaster/crime alarm systems, various safety devices, etc.), you must contact a Sanken sales representative to discuss the suitability of such use and put your signature, or affix your name and seal, on the specification documents of the Sanken Products and return them to Sanken, prior to the use of the Sanken Products. The Sanken Products are not intended for use in any applications that require extremely high reliability such as: aerospace equipment; nuclear power control systems; and medical equipment or systems, whose failure or malfunction may result in death or serious injury to people, i.e., medical devices in Class III or a higher class as defined by relevant laws of Japan (collectively, the “Specific Applications”). Sanken assumes no liability or responsibility whatsoever for any and all damages and losses that may be suffered by you, users or any third party, resulting from the use of the Sanken Products in the Specific Applications or in manner not in compliance with the instructions set forth herein.
- In the event of using the Sanken Products by either (i) combining other products or materials or both therewith or (ii) physically, chemically or otherwise processing or treating or both the same, you must duly consider all possible risks that may result from all such uses in advance and proceed therewith at your own responsibility.
- Although Sanken is making efforts to enhance the quality and reliability of its products, it is impossible to completely avoid the occurrence of any failure or defect or both in semiconductor products at a certain rate. You must take, at your own responsibility, preventative measures including using a sufficient safety design and confirming safety of any equipment or systems in/for which the Sanken Products are used, upon due consideration of a failure occurrence rate and derating, etc., in order not to cause any human injury or death, fire accident or social harm which may result from any failure or malfunction of the Sanken Products. Please refer to the relevant specification documents and Sanken’s official website in relation to derating.
- No anti-radioactive ray design has been adopted for the Sanken Products.
- The circuit constant, operation examples, circuit examples, pattern layout examples, design examples, recommended examples, all information and evaluation results based thereon, etc., described in this document are presented for the sole purpose of reference of use of the Sanken Products.
- Sanken assumes no responsibility whatsoever for any and all damages and losses that may be suffered by you, users or any third party, or any possible infringement of any and all property rights including intellectual property rights and any other rights of you, users or any third party, resulting from the Information.
- No information in this document can be transcribed or copied or both without Sanken’s prior written consent.
- Regarding the Information, no license, express, implied or otherwise, is granted hereby under any intellectual property rights and any other rights of Sanken.
- Unless otherwise agreed in writing between Sanken and you, Sanken makes no warranty of any kind, whether express or implied, including, without limitation, any warranty (i) as to the quality or performance of the Sanken Products (such as implied warranty of merchantability, and implied warranty of fitness for a particular purpose or special environment), (ii) that any Sanken Product is delivered free of claims of third parties by way of infringement or the like, (iii) that may arise from course of performance, course of dealing or usage of trade, and (iv) as to the Information (including its accuracy, usefulness, and reliability).
- In the event of using the Sanken Products, you must use the same after carefully examining all applicable environmental laws and regulations that regulate the inclusion or use or both of any particular controlled substances, including, but not limited to, the EU RoHS Directive, so as to be in strict compliance with such applicable laws and regulations.
- You must not use the Sanken Products or the Information for the purpose of any military applications or use, including but not limited to the development of weapons of mass destruction. In the event of exporting the Sanken Products or the Information, or providing them for non-residents, you must comply with all applicable export control laws and regulations in each country including the U.S. Export Administration Regulations (EAR) and the Foreign Exchange and Foreign Trade Act of Japan, and follow the procedures required by such applicable laws and regulations.
- Sanken assumes no responsibility for any troubles, which may occur during the transportation of the Sanken Products including the falling thereof, out of Sanken’s distribution network.
- Although Sanken has prepared this document with its due care to pursue the accuracy thereof, Sanken does not warrant that it is error free and Sanken assumes no liability whatsoever for any and all damages and losses which may be suffered by you resulting from any possible errors or omissions in connection with the Information.
- Please refer to our official website in relation to general instructions and directions for using the Sanken Products, and refer to the relevant specification documents in relation to particular precautions when using the Sanken Products.
- All rights and title in and to any specific trademark or tradename belong to Sanken and such original right holder(s).

DSGN-CEZ-16003