

August 1991

Features

- 4.0A and 4.5A, 450V - 500V
- $r_{DS(on)} = 1.5\Omega$ and 2.0Ω
- Single Pulse Avalanche Energy Rated*
- SOA is Power-Dissipation Limited
- Nanosecond Switching Speeds
- Linear Transfer Characteristics
- High Input Impedance

Description

The IRF830, IRF831, IRF832, and IRF833 are n-channel enhancement-mode silicon-gate power field-effect transistors. IRF830R, IRF831R, IRF832R and IRF833R types are advanced power MOSFETs designed, tested, and guaranteed to withstand a specified level of energy in the breakdown avalanche mode of operation. All of these power MOSFETs are designed for applications such as switching regulators, switching converters, motor drivers, relay drivers, and drivers for high-power bipolar switching transistors requiring high speed and low gate-drive power. These types can be operated directly from integrated circuits.

The IRF types are supplied in the JEDEC TO-220AB plastic package.

Package

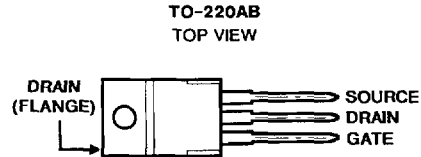

Terminal Diagram

N-CHANNEL ENHANCEMENT MODE

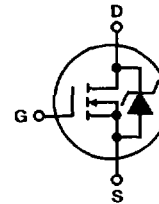

Absolute Maximum Ratings ($T_C = +25^\circ\text{C}$), Unless Otherwise Specified

	IRF830 IRF830R	IRF831 IRF831R	IRF832 IRF832R	IRF833 IRF833R	UNITS
Drain-Source Voltage (1)	V_{DS} 500	450	500	450	V
Drain-Gate Voltage ($R_{GS} = 20k\Omega$) (1)	V_{DGR} 500	450	500	450	V
Continuous Drain Current					
$T_C = +25^\circ\text{C}$	I_D 4.5	4.5	4.0	4.0	A
$T_C = +100^\circ\text{C}$	I_D 3.0	3.0	2.5	2.5	A
Pulsed Drain Current (3)	I_{DM} 18	18	16	16	A
Gate-Source Voltage	V_{GS} ± 20	± 20	± 20	± 20	V
Maximum Power Dissipation					
$T_C = +25^\circ\text{C}$	P_D 75	75	75	75	W
Linear Derating Factor	0.6	0.6	0.6	0.6	W/ $^\circ\text{C}$
Inductive Current, Clamped	I_{LM} 18	18	16	16	A
(See Figure 14, $L = 100\mu\text{H}$)					
Single Pulse Avalanche Energy Rating (4)	E_{AS}^* 300	300	300	300	mJ
Operating and Storage Junction	T_J, T_{STG} -55 to +150	-55 to +150	-55 to +150	-55 to +150	$^\circ\text{C}$
Temperature Range					
Maximum Lead Temperature for Soldering	T_L 300	300	300	300	$^\circ\text{C}$
(0.063" (1.6mm) from case for 10s)					

NOTES:

1. $T_J = +25^\circ\text{C}$ to $+150^\circ\text{C}$.
 2. Pulse Test: Pulse width $\leq 300\mu\text{s}$, Duty Cycle $\leq 2\%$.
 3. Repetitive rating: Pulse width limited by maximum junction temperature. See Transient Thermal Impedance Curve (Figure 5).
 4. $V_{DD} = 50\text{V}$, starting $T_J = +25^\circ\text{C}$, $L = 25\text{mH}$, $R_{GS} = 25\Omega$, $I_{PEAK} = 4.5\text{A}$. See Figure 15.
- *R Suffix Types Only

4
**N-CHANNEL
POWER MOSFETs**

IRF830, IRF831, IRF832, IRF833 IRF830R, IRF831R, IRF832R, IRF833R

Electrical Characteristics $T_C = 25^\circ\text{C}$, Unless Otherwise Specified

CHARACTERISTIC	SYMBOL	TEST CONDITIONS	LIMITS			UNITS
			MIN	TYP	MAX	
Drain-Source Breakdown Voltage IRF830/832, IRF830R/832R IRF831/833, IRF831R/833R	BV _{DSS}	V _{GS} = 0V, I _D = 250 μ A	500	-	-	V
			450	-	-	V
Gate Threshold Voltage	V _{GS(TH)}	V _{DS} = V _{GS} , I _D = 250 μ A	2.0	-	4.0	V
Gate-Source Leakage Forward	I _{GSS}	V _{GS} = 20V	-	-	500	nA
Gate-Source Leakage Reverse	I _{GSS}	V _{GS} = -20V	-	-	-500	nA
Zero Gate Voltage Drain Current	I _{DSS}	V _{DS} = Max Rating, V _{GS} = 0V	-	-	250	μ A
		V _{DS} = Max Rating x 0.8, V _{GS} = 0V, T _J = +125 $^\circ$ C	-	-	1000	μ A
On-State Drain Current (Note 2) IRF830/831, IRF830R/831R IRF832/833, IRF832R/833R	I _{D(ON)}	V _{DS} > I _{D(ON)} x R _{DS(ON)} Max, V _{GS} = 10V	4.5	-	-	A
			4.0	-	-	A
Static Drain-Source On-State Resistance (Note 2) IRF830/831, IRF830R/831R IRF832/833, IRF832R/833R	r _{DS(ON)}	V _{GS} = 10V, I _D = 2.5A	-	1.3	1.5	Ω
			-	1.5	2.0	Ω
Forward Transconductance (Note 2)	g _{fs}	V _{DS} \geq 50V, I _D = 2.5A	2.7	4.2	-	S(Ω)
Input Capacitance	C _{ISS}	V _{GS} = 0V, V _{DS} = 25V, f = 1.0MHz	-	600	-	pF
Output Capacitance	C _{OSS}	See Figure 10	-	100	-	pF
Reverse Transfer Capacitance	C _{RSS}		-	20	-	pF
Turn-On Delay Time	t _{d(ON)}	V _{DD} = 250V, I _D = 4.5A, R _G = 12 Ω	-	10	17	ns
Rise Time	t _r	See Figure 16. (MOSFET switching times are essentially independent of operating temperature)	-	15	23	ns
Turn-Off Delay Time	t _{d(OFF)}		-	33	53	ns
Fall Time	t _f		-	16	23	ns
Total Gate Charge (Gate-Source + Gate-Drain)	Q _g	V _{GS} = 10V, I _D = 4.5A, V _{DS} = 0.8V Max Rating. See Figure 17 for test circuit.	-	22	32	nC
Gate-Source Charge	Q _{gs}	(Gate charge is essentially independent of operating temperature.)	-	3.5	-	nC
Gate-Drain ("Miller") Charge	Q _{gd}		-	11	-	nC
Internal Drain Inductance	L _D	Measured from the contact screw on tab to center of die	-	3.5	-	nH
		Measured from the drain lead, 6mm (0.25in.) from package to center of die	-	4.5	-	nH
Internal Source Inductance	L _S	Measured from the source lead, 6mm (0.25") from header and source bonding pad.	-	7.5	-	nH
Junction-to-Case	R _{θJC}		-	-	1.67	$^\circ\text{C}/\text{W}$
Case-to-Sink	R _{θCS}	Mounting surface flat, smooth and greased	-	0.5	-	$^\circ\text{C}/\text{W}$
Junction-to-Ambient	R _{θJA}	Free air operation	-	-	80	$^\circ\text{C}/\text{W}$

Source Drain Diode Ratings and Characteristics

Continuous Source Current (Body Diode)	I _S	Modified MOSFET symbol showing the integral reverse P-N junc. rectifier.	-	-	4.5	A
Pulse Source Current (Body Diode) (Note 3)	I _{SM}		-	-	18	A
Diode Forward Voltage (Note 2)	V _{SD}	T _J = +25 $^\circ$ C, I _S = 4.5A, V _{GS} = 0V	-	-	1.6	V
Reverse Recovery Time	t _{rr}	T _J = +25 $^\circ$ C, I _F = 4.5A, dI _F /dt = 100A/ μ s	180	350	760	ns
Reverse Recovered Charge	Q _{RR}	T _J = +25 $^\circ$ C, I _F = 4.5A, dI _F /dt = 100A/ μ s	0.96	2.2	4.3	μ C
Forward Turn-on Time	t _{ON}	Intrinsic turn-on time is negligible. Turn-on speed is substantially controlled by L _S + L _D .	-	-	-	-

NOTES: 1. T_J = +25 $^\circ$ C to +150 $^\circ$ C
2. Pulse Test: Pulse width \leq 300 μ s, Duty Cycle \leq 2%

3. Repetitive Rating: Pulse width limited by max. junction temperature. See Transient Thermal Impedance Curve (Figure 5)

4. V_{DD} = 50V, Start T_J = +25 $^\circ$ C, L = 25mH, R_{GS} = 25 Ω , I_{PEAK} = 4.5A (See Figure 15)

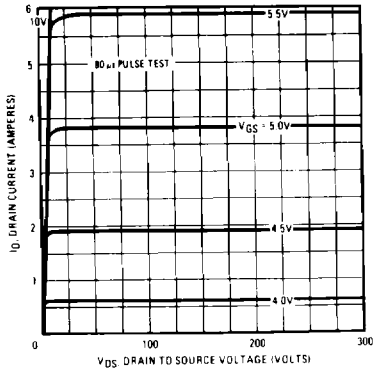

Fig. 1 - Typical Output Characteristics

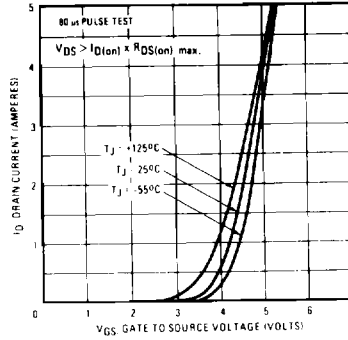

Fig. 2 - Typical Transfer Characteristics

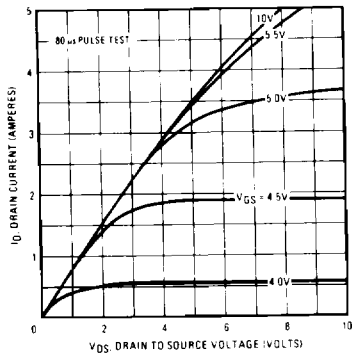

Fig. 3 - Typical Saturation Characteristics

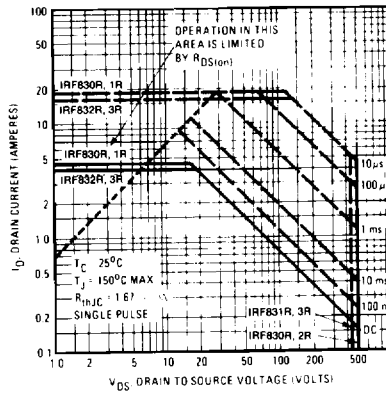

Fig. 4 - Maximum Safe Operating Area

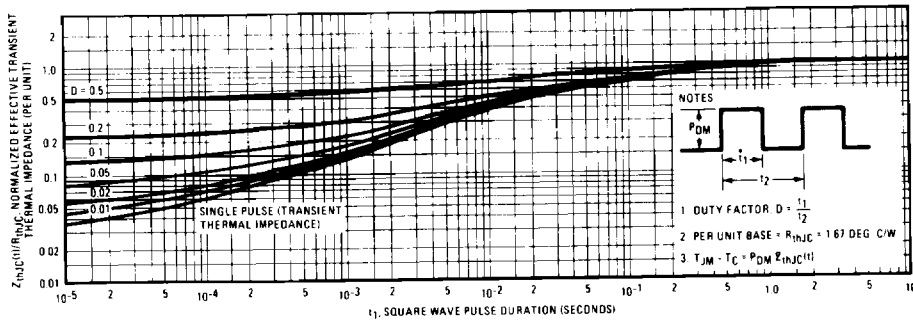

Fig. 5 - Maximum Effective Transient Thermal Impedance, Junction-to-Case Vs. Pulse Duration

4

N-CHANNEL
POWER MOSFETS

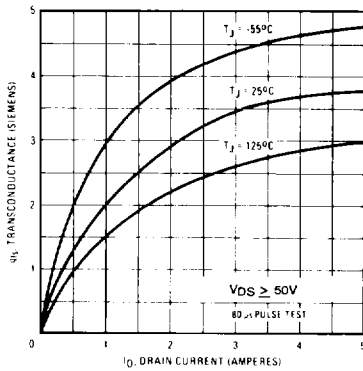

Fig. 6 — Typical Transconductance Vs. Drain Current

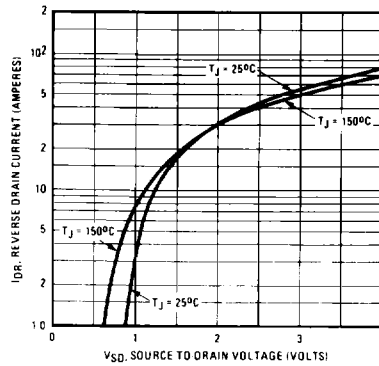

Fig. 7 — Typical Source-Drain Diode Forward Voltage

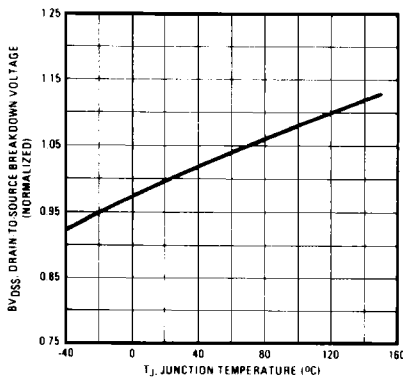

Fig. 8 — Breakdown Voltage Vs. Temperature

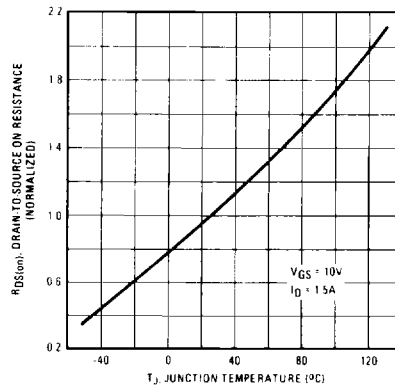

Fig. 9 — Normalized On-Resistance Vs. Temperature

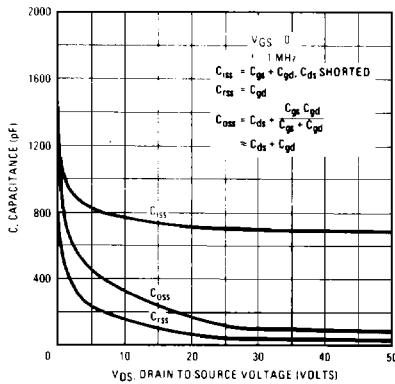

Fig. 10 — Typical Capacitance Vs. Drain-to-Source Voltage

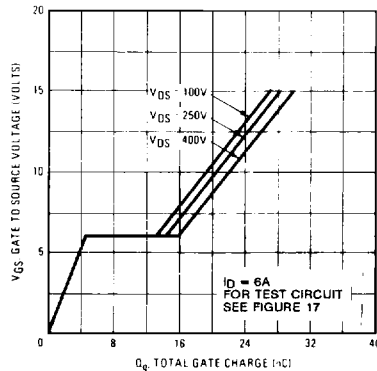

Fig. 11 — Typical Gate Charge Vs. Gate-to-Source Voltage

IRF830, IRF831, IRF832, IRF833 IRF830R, IRF831R, IRF832R, IRF833R

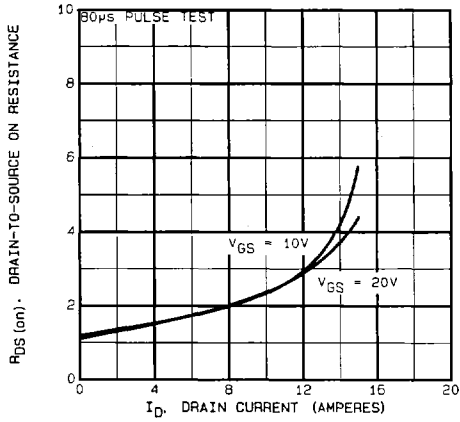

Fig. 12 — Typical On-Resistance Vs. Drain Current

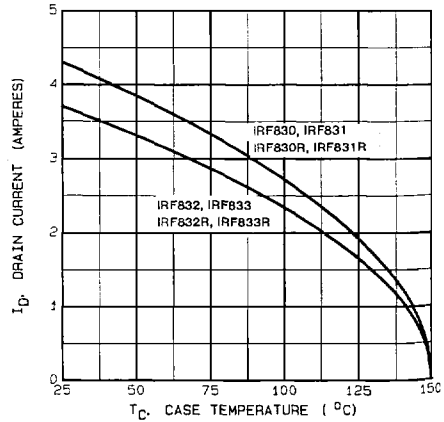

Fig. 13 — Maximum Drain Current Vs. Case Temperature

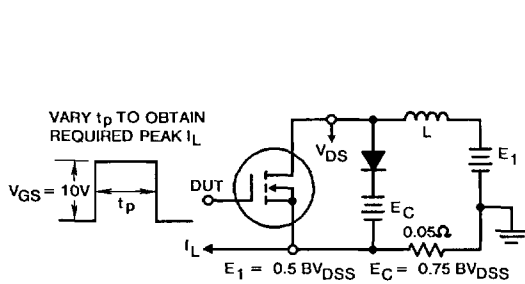

Fig. 14a — Clamped Inductive Test Circuit

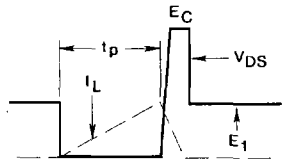

Fig. 14b — Clamped Inductive Waveforms

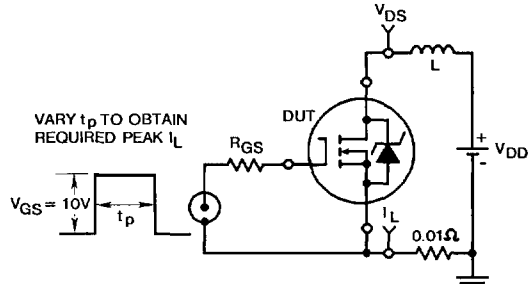

Fig. 15a — Unclamped Energy Test Circuit

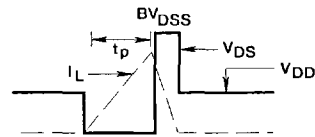

Fig. 15b — Unclamped Energy Waveforms

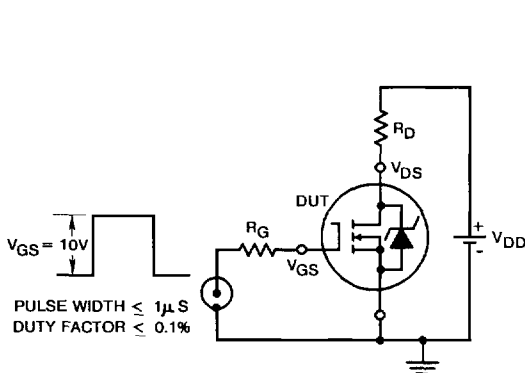

Fig. 16 — Switching Time Test Circuit

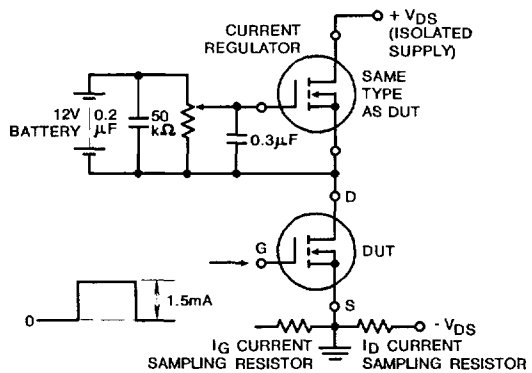

Fig. 17 — Gate Charge Test Circuit

4

N-CHANNEL POWER MOSFETS