



**PCB PIN POLARISATION
OPTION A AND B**



COLOUR STRIPE OPTION



COLOUR STRIPE OPTION

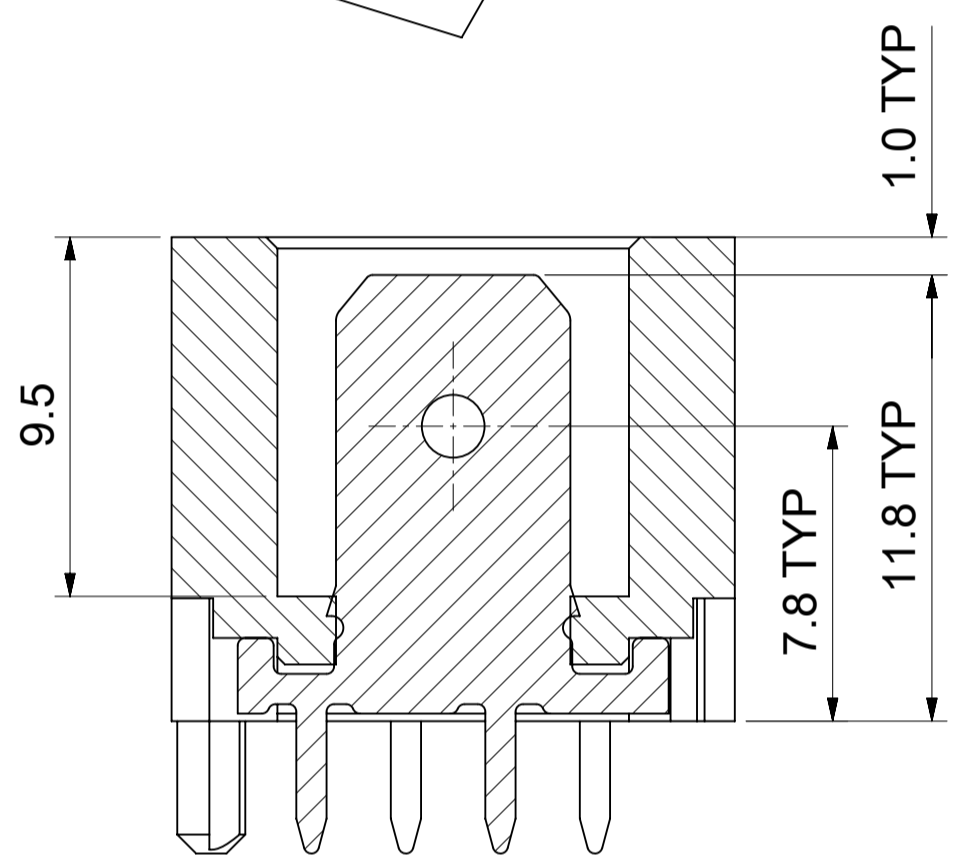

SECTION A-A

CCT	DIM A	DIM B	DIM C	TOL
2	5.00	10.20	12.30	+/-0.30
3	10.00	15.20	17.30	
4	15.00	20.20	22.30	
5	20.00	25.20	27.30	
6	25.00	30.20	32.30	
7	30.00	35.20	37.30	
8	35.00	40.20	42.30	
9	40.00	45.20	47.30	
10	45.00	50.20	52.30	
11	50.00	55.20	57.30	
12	55.00	60.20	62.30	

- NOTES:**
- MATERIALS**
HOUSING: PA 66, UL94 V-0 750°C GWT NO FLAME
TERMINAL: BRASS 0.80REF. THICK
PLATING: OPTIONAL (SEE CHARTS SHEETS 2-18)
TIN PLATING OPTION : 3µm TIN OVER 1.27µm NICKEL ALL AREAS
 - SELECTIVE SILVER**
CONTACT AREA : 2µm SILVER OVER 1.27µm NICKEL. ALL OTHER AREAS FLASH OF SILVER 0.10µm
 - PRODUCT CONFORMS TO SPECIFICATION PS-99020-0037/39
 - MATES WITH MOLEX 91338, 90833, 90835, 91777, 91778, 91779, 91954 & 92000.
 - SEE PACKAGING SPECIFICATION PK-90858-001
THREE PACKAGING OPTIONS :
"A" LOOSE IN POLYBAGS IN SHIPPING CARTON
 - PLATED THRU HOLE
 - NON-PLATED THRU HOLE
 - RECOMMENDED PCB THICKNESS: 1.5mm REF
 - PCB VIEW IS FROM SOLDER SIDE

OPTION "C"

PCB LAYOUT

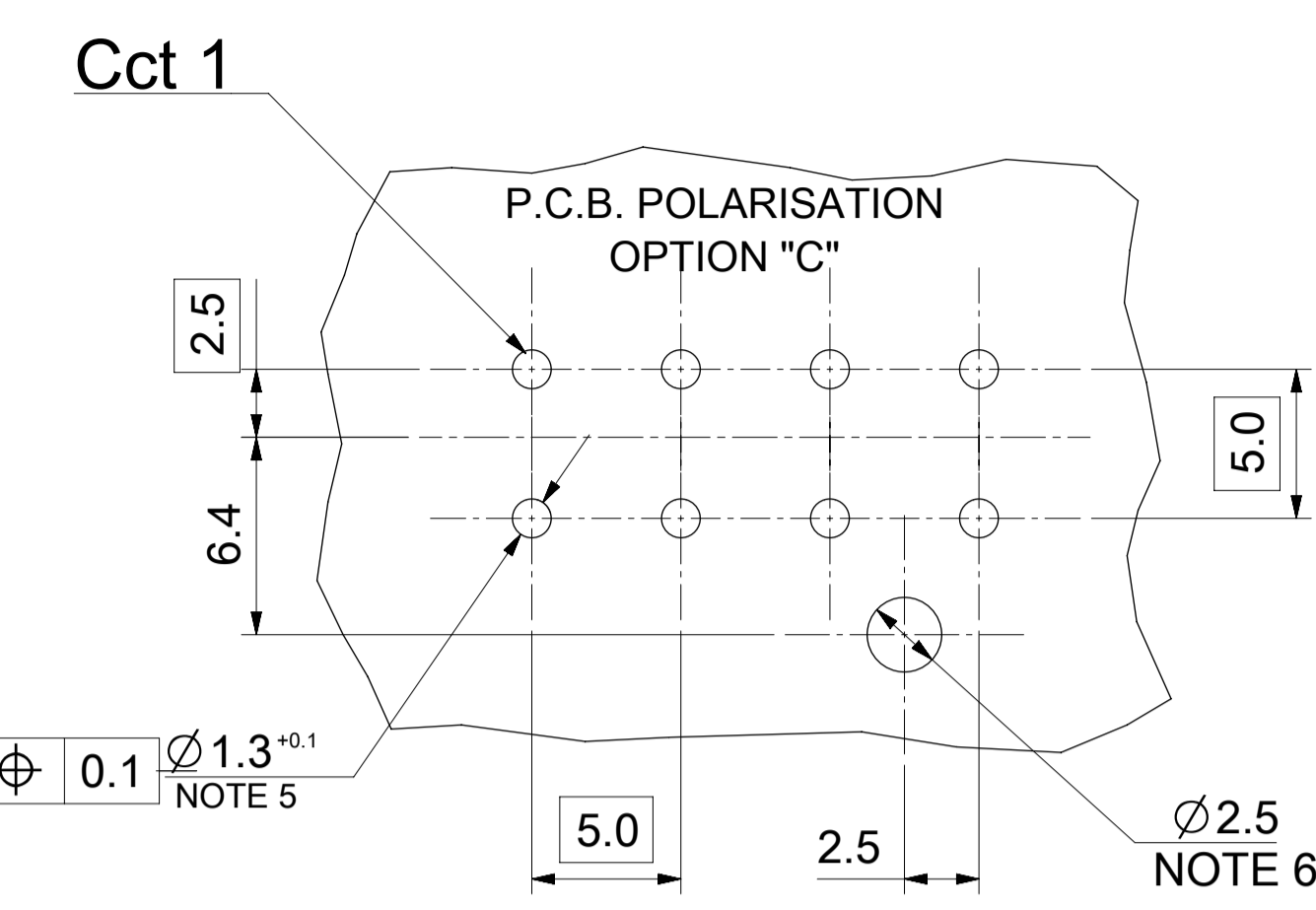
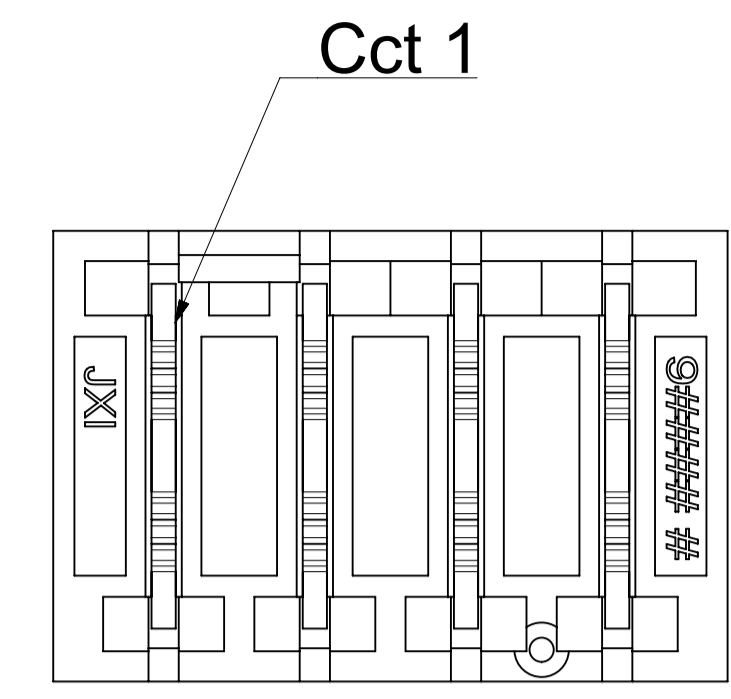

OPTION "B"

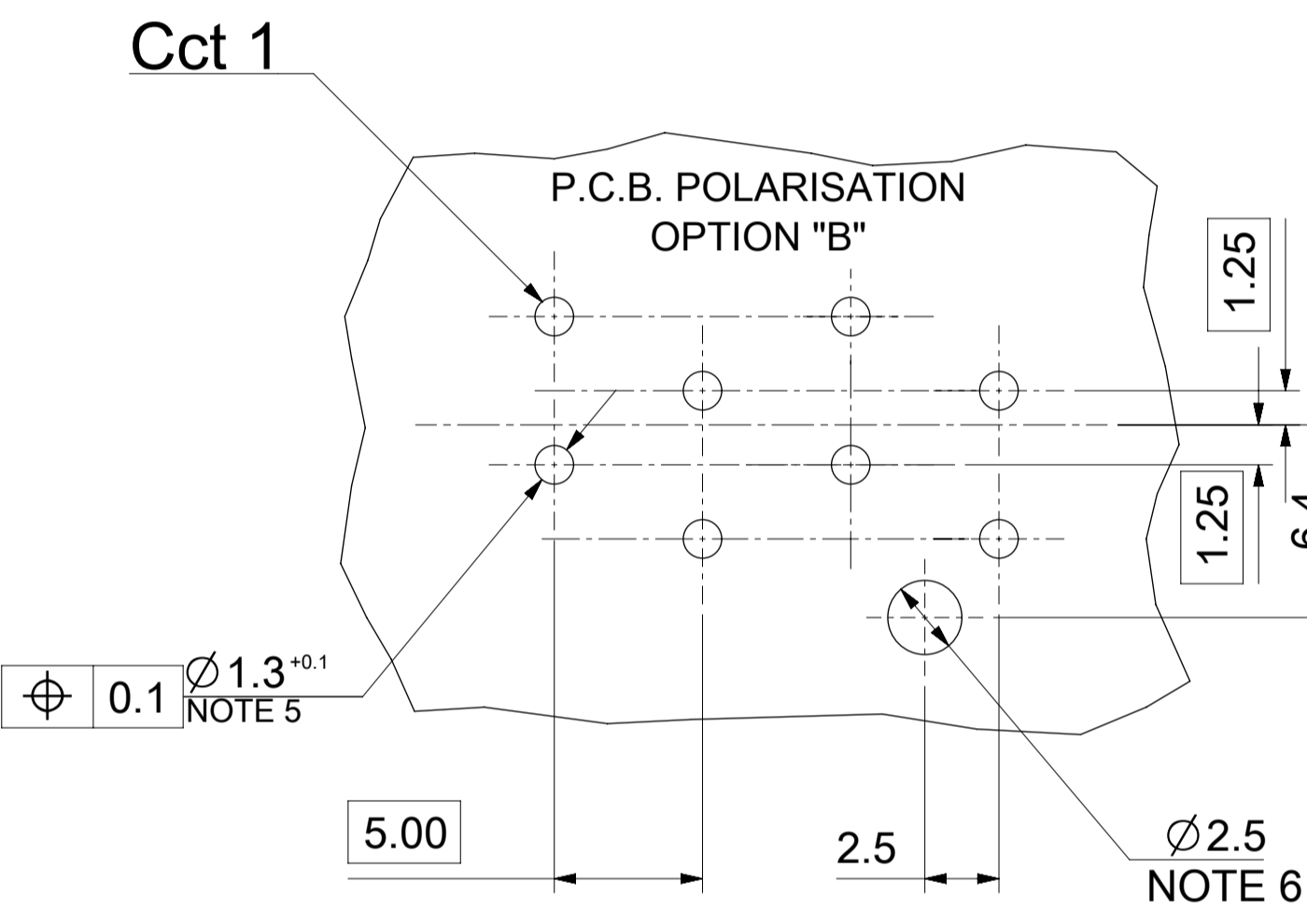
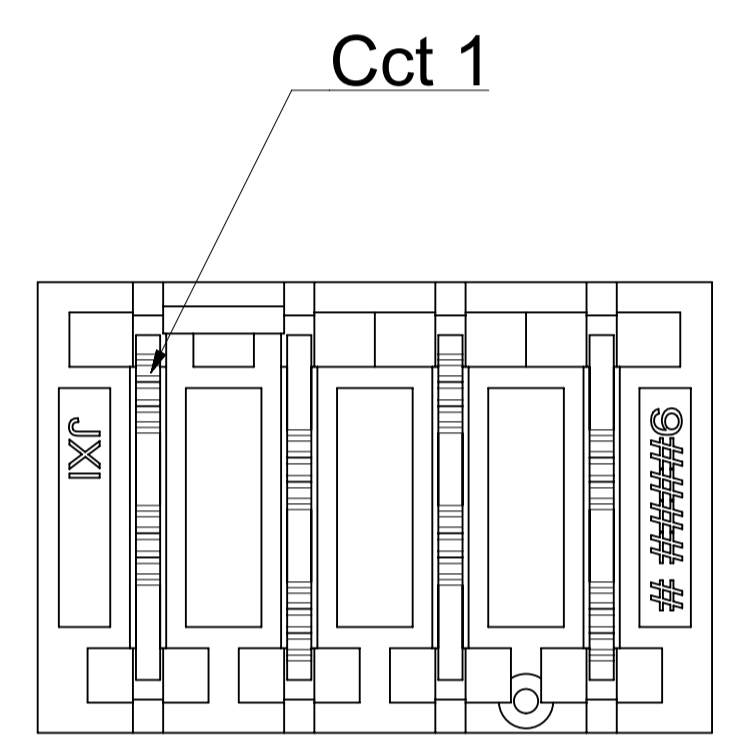

OPTION "A"

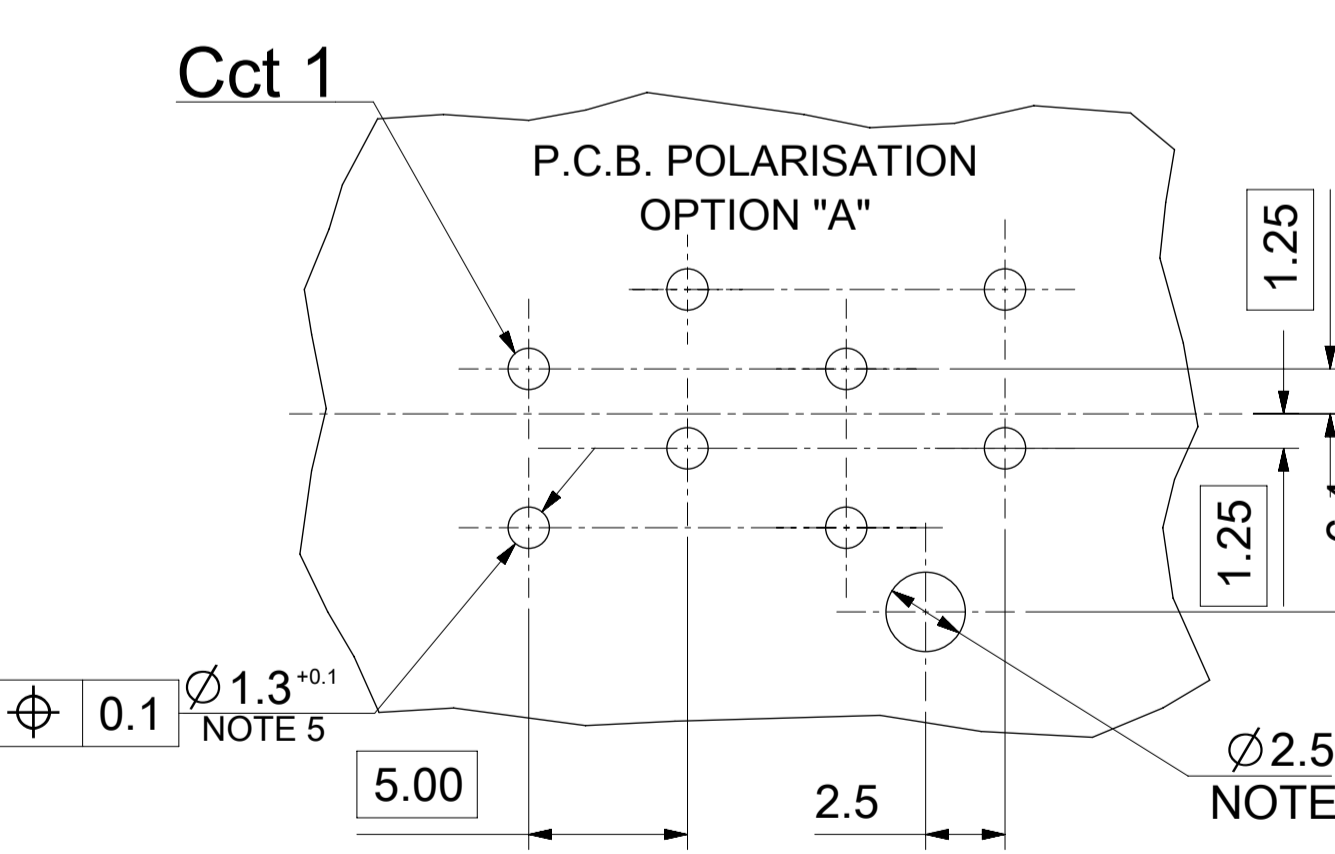
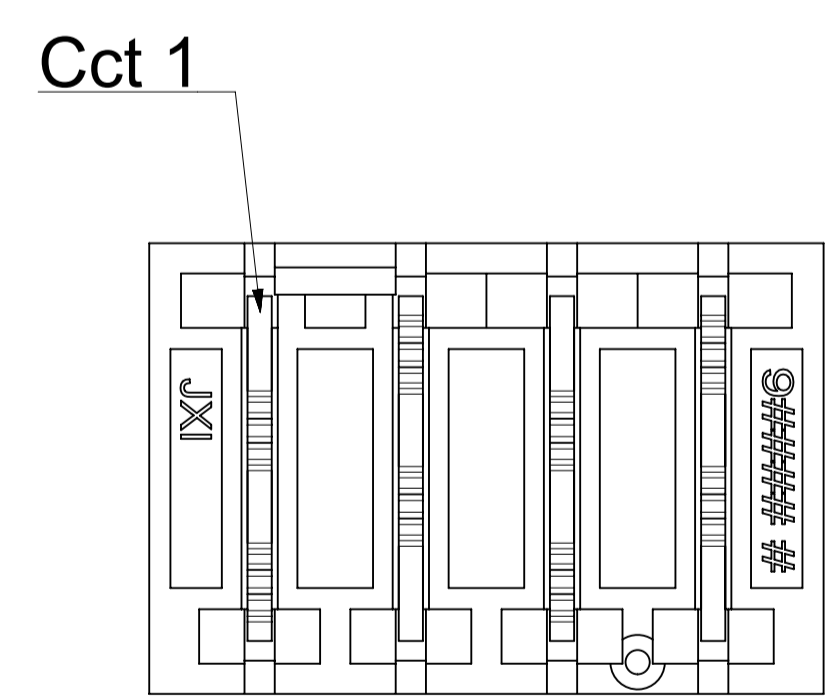

THIS DRAWING CONTAINS INFORMATION THAT IS PROPRIETARY TO MOLEX ELECTRONIC TECHNOLOGIES, LLC AND SHOULD NOT BE USED WITHOUT WRITTEN PERMISSION

DIMENSION UNITS	SCALE	CURRENT REV DESC:		molex	
mm	1:1				
GENERAL TOLERANCES (UNLESS SPECIFIED)		EC NO: 746008		RAST 5 VERT HDR PA 66 HOUSING	
ANGULAR TOL	± 2.0°	DRWN: RAHULH3	2023/04/10	PRODUCT CUSTOMER DRAWING	
4 PLACES	±	CHK'D: RAHULH3	2023/04/14	DOCUMENT NUMBER	
3 PLACES	±	APPR: MRAMAKRISHNA	2023/04/14	DOC TYPE DOC PART REVISION	
2 PLACES	± 0.1	INITIAL REVISION:		919990001	
1 PLACE	± 0.2	DRWN: AKABADI	2017/09/15	PSD	000
0 PLACES	±	APPR: BRUTTLE	2017/11/10	L4	
DRAFT WHERE APPLICABLE MUST REMAIN WITHIN DIMENSIONS		THIRD ANGLE PROJECTION	DRAWING	SERIES	MATERIAL NUMBER
			A1-SIZE	91999	CUSTOMER
					SEE SHEETS 2-18
					GENERAL MARKET
					SHEET NUMBER
					1 OF 17

2 CIRCUIT

SEE CODE DESIGNATION TABLE FOR NUMBERING
FORMAT WHEN ADDING NEW PART NUMBE

PART NO. (TIN)	TERM NO. (TIN)	MOLEX HOUSING NO.	COLOUR	UNBLOCKED POSITION KEYS	UNBLOCKED CODING KEYS	LATCH POSITION	CONFIGURATION (SEE NOTES)	TERMINAL VOID CKT	TERM NO. (SILVER)	PART NO. (SILVER)	P.C.B. POLARISATION OPTION	PACKAGING OPTION *	COLOUR STRIPE
91999-0003	91703-0002	93002-0002	NATURAL	1b 2a	01c d20	1/2		NONE	91703-0003	91999-0499	A	A	NONE
91999-0004	91703-0002	93002-0003	NATURAL	1a 2b	01c	1/2		NONE	91703-0003	91999-0482	A	A	NONE
91999-0007	91703-0002	93002-0004	NATURAL	1b 2b	01c	1/2		NONE	91703-0003	91999-0497	A	A	NONE
91999-0018	91703-0002	93002-0005	NATURAL	2a	01c d20	1/2		NONE	91703-0003	91999-0495	A	A	NONE
91999-0019	91703-0002	93002-0008	NATURAL	1a 2b	d20	1/2		NONE	91703-0003	91999-0478	A	A	NONE
91999-0021	91703-0002	93002-0006	NATURAL	1b	01c d20	1/2		NONE	91703-0003	91999-0492	A	A	NONE
91999-0022	91703-0002	93002-0007	NATURAL	1a 2b	NONE	1/2		NONE	91703-0003	91999-0491	A	A	NONE
91999-0027	91703-0002	93002-0009	NATURAL	2b	NONE	1/2		NONE	91703-0003	91999-0487	A	A	NONE
91999-0029	91703-0002	93002-0010	NATURAL	1a 1b	d20	1/2		NONE	91703-0003	91999-0486	A	A	NONE
91999-0030	91703-0002	93002-0011	NATURAL	2a 2b	NONE	1/2		NONE	91703-0003	91999-0485	A	A	NONE
91999-0032	91703-0002	93002-0012	NATURAL	2b	d20	1/2		NONE	91703-0003	91999-0484	A	A	NONE
91999-0047	91703-0002	93002-0013	NATURAL	1a 2a	01c d20	1/2		NONE	91703-0003	91999-0483	A	A	NONE
91999-0055	91703-0002	93002-0014	NATURAL	1a 1b	NONE	1/2		NONE	91703-0003	91999-0480	A	A	NONE
91999-0020	91703-0002	93002-0015	NATURAL	1a 1b	01c	1/2		NONE	91703-0003	91999-0475	A	A	NONE
91999-0054	91703-0002	93002-0016	NATURAL	2b	01c d20	1/2		NONE	91703-0003	91999-0476	A	A	NONE
91999-0057	91703-0002	93002-0017	NATURAL	1a	01c d20	1/2		NONE	91703-0003	91999-0477	A	A	NONE
91999-0058	91703-0002	93002-0018	NATURAL	1a 2a	01c	1/2		NONE	91703-0003	91999-0472	A	A	NONE
91999-0059	91703-0002	93002-0019	NATURAL	ALL	d20	1/2		NONE	91703-0003	91999-0474	A	A	NONE
91999-0060	91703-0002	93002-0020	NATURAL	1b 2a 2b	d20	1/2		NONE	91703-0003	91999-0473	A	A	NONE
91999-0061	91703-0002	93002-0002	NATURAL	1b 2a	01c d20	1/2		NONE	91703-0003	91999-0471	B	A	NONE

NOTES:
* SEE SHEET 1 NOTE 4

THIS DRAWING CONTAINS INFORMATION THAT IS PROPRIETARY TO MOLEX ELECTRONIC TECHNOLOGIES, LLC AND SHOULD NOT BE USED WITHOUT WRITTEN PERMISSION																					
DIMENSION UNITS mm		SCALE 1:1		CURRENT REV DESC:				 RAST 5 VERT HDR PA 66 HOUSING													
GENERAL TOLERANCES (UNLESS SPECIFIED)				EC NO: 746008 DRWN: RAHULH3 2023/04/10 CHK'D: RAHULH3 2023/04/14 APPR: MRAMAKRISHNA 2023/04/14																	
ANGULAR TOL ± 2.0°		4 PLACES ±		3 PLACES ±		2 PLACES ± 0.1		1 PLACE ± 0.2		0 PLACES ±		PRODUCT CUSTOMER DRAWING									
DRAFT WHERE APPLICABLE MUST REMAIN WITHIN DIMENSIONS				THIRD ANGLE PROJECTION		DRAWING 		SERIES A1-SIZE 91999		MATERIAL NUMBER SEE SHEETS 2-18		CUSTOMER GENERAL MARKET		DOCUMENT NUMBER 919990001		DOC TYPE PSD		DOC PART 000		REVISION L4	
DOCUMENT STATUS		P1		RELEASE DATE		2023/04/14 14:04:31															

2 CIRCUIT

SEE CODE DESIGNATION TABLE FOR NUMBERING
FORMAT WHEN ADDING NEW PART NUMBE

PART NO. (TIN)	TERM NO. (TIN)	MOLEX HOUSING NO.	COLOUR	UNBLOCKED POSITION KEYS	UNBLOCKED CODING KEYS	LATCH POSITION	CONFIGURATION (SEE NOTES)	TERMINAL VOID CKT	TERM NO. (SILVER)	PART NO. (SILVER)	P.C.B. POLARISATION OPTION	PACKAGING OPTION *	COLOUR STRIPE
91999-0062	91703-0002	93002-0021	NATURAL	2a	01c	1/2		NONE	91703-0003	91999-0470	A	A	NONE
91999-0063	91703-0002	93002-0022	NATURAL	1b 2a	d20	1/2		NONE	91703-0003	91999-0469	A	A	NONE
91999-0064	91703-0002	93002-0023	NATURAL	1a 2b	01c d20	1/2		NONE	91703-0003	91999-0468	A	A	NONE
91999-0067	91703-0002	93002-0024	NATURAL	ALL	ALL	1/2		NONE	91703-0003	91999-0465	A	A	NONE
91999-0069	91703-0002	93002-0025	NATURAL	1a	01c	1/2		NONE	91703-0003	91999-0463	A	A	NONE
91999-0071	91703-0017	93002-0004	NATURAL	1b 2b	01c	1/2		NONE	91703-0018	91999-0461	C	A	NONE
91999-0042	91703-0002	93002-0027	NATURAL	NONE	d20	1/2		NONE	91703-0003	91999-0460	A	A	NONE
91999-0072	91703-0017	93002-0002	NATURAL	1b 2a	01c d20	1/2		NONE	91703-0018	91999-0459	C	A	NONE
91999-0073	91703-0002	93002-0002	NATURAL	1b 2a	01c d20	1/2		NONE	91703-0003	91999-0458	B	A	NONE
91999-0074	91703-0002	93002-0003	NATURAL	1a 2b	01c	1/2		NONE	91703-0003	91999-0457	B	A	NONE
91999-0075	91703-0017	93002-0005	NATURAL	2a	01c d20	1/2		NONE	91703-0018	91999-0456	C	A	NONE
91999-0076	91703-0002	93002-0005	NATURAL	2a	01c d20	1/2		NONE	91703-0003	91999-0455	B	A	NONE
91999-0077	91703-0002	93002-0028	NATURAL	1a 2a 2b	01c d20	1/2		NONE	91703-0003	91999-0454	A	A	NONE
91999-0078	91703-0002	93002-0029	NATURAL	1b	d20	1/2		NONE	91703-0003	91999-0453	A	A	NONE
91999-0079	91703-0002	93002-0030	NATURAL	1b	NONE	1/2		NONE	91703-0003	91999-0452	A	A	NONE
91999-0080	91703-0002	93002-0031	NATURAL	NONE	01c d20	1/2		NONE	91703-0003	91999-0451	A	A	NONE

NOTES:
* SEE SHEET 1 NOTE 4

THIS DRAWING CONTAINS INFORMATION THAT IS PROPRIETARY TO MOLEX ELECTRONIC TECHNOLOGIES, LLC AND SHOULD NOT BE USED WITHOUT WRITTEN PERMISSION																					
DIMENSION UNITS mm		SCALE 1:1		CURRENT REV DESC:				 RAST 5 VERT HDR PA 66 HOUSING													
GENERAL TOLERANCES (UNLESS SPECIFIED)				EC NO: 746008 DRWN: RAHULH3 2023/04/10 CHK'D: RAHULH3 2023/04/14 APPR: MRAMAKRISHNA 2023/04/14																	
ANGULAR TOL ± 2.0°		4 PLACES ±		3 PLACES ±		2 PLACES ± 0.1		1 PLACE ± 0.2		0 PLACES ±		PRODUCT CUSTOMER DRAWING									
DRAFT WHERE APPLICABLE MUST REMAIN WITHIN DIMENSIONS				THIRD ANGLE PROJECTION		DRAWING 		SERIES A1-SIZE 91999		MATERIAL NUMBER SEE SHEETS 2-18		CUSTOMER GENERAL MARKET		DOCUMENT NUMBER 919990001		DOC TYPE PSD		DOC PART 000		REVISION L4	
DOCUMENT STATUS		P1		RELEASE DATE		2023/04/14 14:04:31															

2 CIRCUIT

SEE CODE DESIGNATION TABLE FOR NUMBERING
FORMAT WHEN ADDING NEW PART NUMBE

PART NO. (TIN)	TERM NO. (TIN)	MOLEX HOUSING NO.	COLOUR	UNBLOCKED POSITION KEYS	UNBLOCKED CODING KEYS	LATCH POSITION	CONFIGURATION (SEE NOTES)	TERMINAL VOID CKT	TERM NO. (SILVER)	PART NO. (SILVER)	P.C.B. POLARISATION OPTION	PACKAGING OPTION *	COLOUR STRIPE
91999-0081	91703-0002	93002-0003	NATURAL	1a 2b	01c	1/2		NONE	91703-0003	91999-0450	A	A	RED
91999-0082	91703-0002	93002-0032	NATURAL	ALL	01c	1/2		NONE	91703-0003	91999-0449	A	A	NONE
91999-0083	91703-0002	93002-0033	NATURAL	1a 1b 2a	NONE	1/2		NONE	91703-0003	91999-0448	A	A	NONE
91999-0084	91703-0002	93002-0008	NATURAL	1a 2b	d20	1/2		CCT 1	91703-0003	91999-0447	A	A	NONE
91999-0085	91703-0002	93002-0008	NATURAL	1a 2b	d20	1/2		CCT 2	91703-0003	91999-0446	A	A	NONE
91999-0086	91703-0017	93002-0008	NATURAL	1a 2b	d20	1/2		NONE	91703-0018	91999-0445	C	A	NONE
91999-0087	91703-0002	93002-0034	NATURAL	1a	NONE	1/2		NONE	91703-0003	91999-0444	A	A	NONE
91999-0088	91703-0002	93002-0009	NATURAL	2b	NONE	1/2		NONE	91703-0003	91999-0443	B	A	NONE
91999-0089	91703-0002	93002-0002	NATURAL	1b 2a	01c d20	1/2		NONE	91703-0003	91999-0442	A	A	BLACK
91999-0090	91703-0002	93002-0036	NATURAL	1b 2b	01c d20	1/2		NONE	91703-0003	91999-0496	A	A	NONE
91999-0091	91703-0002	93002-0035	NATURAL	1b 2a 2b	01c d20	1/2		NONE	91703-0003	91999-0441	A	A	NONE
91999-0092	91703-0002	93002-0024	NATURAL	1a 1b 2a 2b	01c d20	1/2		NONE	91703-0003	91999-0440	A	A	NONE
91999-0093	91703-0002	93002-0026	NATURAL	2a 2b	01c	1/2		NONE	91703-0003	91999-0439	A	A	NONE
91999-0094	91703-0002	93002-0016	NATURAL	2b	01c d20	1/2		NONE	91703-0003	91999-0438	B	A	NONE

L4

NOTES:

* SEE SHEET 1 NOTE 4

THIS DRAWING CONTAINS INFORMATION THAT IS PROPRIETARY TO MOLEX ELECTRONIC TECHNOLOGIES, LLC AND SHOULD NOT BE USED WITHOUT WRITTEN PERMISSION											
DIMENSION UNITS mm		SCALE 1:1		CURRENT REV DESC:							
GENERAL TOLERANCES (UNLESS SPECIFIED)				EC NO: 746008							
ANGULAR TOL ± 2.0°		4 PLACES ±		DRWN: RAHULH3		2023/04/10		RAST 5 VERT HDR PA 66 HOUSING			
3 PLACES ±		2 PLACES ± 0.1		CHK'D: RAHULH3		2023/04/14		PRODUCT CUSTOMER DRAWING			
1 PLACE ± 0.2		0 PLACES ±		APPR: MRAMAKRISHNA		2023/04/14		INITIAL REVISION:			
DRAFT WHERE APPLICABLE MUST REMAIN WITHIN DIMENSIONS		THIRD ANGLE PROJECTION		DRAWING		SERIES		DOCUMENT NUMBER		DOC TYPE DOC PART REVISION	
				A1-SIZE		91999		919990001		PSD 000 L4	
				SEE SHEETS 2-18		GENERAL MARKET		MATERIAL NUMBER		CUSTOMER	
										SHEET NUMBER	
										4 OF 17	

3 CIRCUIT

SEE CODE DESIGNATION TABLE FOR NUMBERING
FORMAT WHEN ADDING NEW PART NUMBE

PART NO. (TIN)	TERM NO. (TIN)	MOLEX HOUSING NO.	COLOUR	UNBLOCKED POSITION KEYS	UNBLOCKED CODING KEYS	LATCH POSITION	CONFIGURATION (SEE NOTES)	TERMINAL VOID CKT	TERM NO. (SILVER)	PART NO. (SILVER)	P.C.B. POLARISATION OPTION	PACKAGING OPTION *	COLOUR STRIPE
91999-0502	91703-0002	93002-1000	NATURAL	1b	01c d20	1/2		NONE	91703-0003	91999-1249	A	A	NONE
91999-0508	91703-0002	93002-1001	NATURAL	1a	03c	1/2		NONE	91703-0003	91999-1248	A	A	NONE
91999-0511	91703-0002	93002-1002	NATURAL	1a 1b	d30	1/2		NONE	91703-0003	91999-1247	A	A	NONE
91999-0512	91703-0002	93002-1003	NATURAL	1a 3b	01c	1/2		NONE	91703-0003	91999-1246	A	A	NONE
91999-0513	91703-0002	93002-1004	NATURAL	1b	d20 03c	1/2		NONE	91703-0003	91999-1245	A	A	NONE
91999-0524	91703-0002	93002-1005	NATURAL	1b 2a 2b	d30	1/2		NONE	91703-0003	91999-1244	A	A	NONE
91999-0525	91703-0002	93002-1006	NATURAL	2b	d20	1/2		NONE	91703-0003	91999-1243	A	A	NONE
91999-0528	91703-0002	93002-1007	NATURAL	ALL	d10 d30	2/3		NONE	91703-0003	91999-1242	A	A	NONE
91999-0527	91703-0002	93002-1008	NATURAL	ALL	d20	1/2		NONE	91703-0003	91999-1240	A	A	NONE
91999-0526	91703-0002	93002-1009	NATURAL	2b 3b	d10 02c	2/3		NONE	91703-0003	91999-1241	A	A	NONE
91999-0529	91703-0002	93002-1000	NATURAL	1b	01c d20	1/2		2	91703-0003	91999-1239	A	A	NONE
91999-0530	91703-0002	93002-1010	NATURAL	2b 3b	01c d10 02c d30	2/3		NONE	91703-0003	91999-1238	A	A	NONE
91999-0531	91703-0002	93002-1011	NATURAL	3b	01c d30	2/3		NONE	91703-0003	91999-1237	A	A	NONE
91999-0532	91703-0002	93002-1012	NATURAL	3b	d10 02c	2/3		NONE	91703-0003	91999-1236	A	A	NONE
91999-0534	91703-0002	93002-1014	NATURAL	ALL	ALL	1/2		NONE	91703-0003	91999-1234	A	A	NONE
91999-0506	91703-0002	93002-1015	NATURAL	1a 3a	d20	1/2		NONE	91703-0003	91999-1233	A	A	NONE
91999-0507	91703-0002	93002-1016	NATURAL	2a	d10 d30	2/3		NONE	91703-0003	91999-1232	A	A	NONE
91999-0535	91703-0002	93002-1017	NATURAL	3b	d10 d30	2/3		NONE	91703-0003	91999-1231	A	A	NONE
91999-0536	91703-0002	93002-1018	NATURAL	1b	01c	1/2		NONE	91703-0003	91999-1230	A	A	NONE

NOTES:
* SEE SHEET 1 NOTE 4

THIS DRAWING CONTAINS INFORMATION THAT IS PROPRIETARY TO MOLEX ELECTRONIC TECHNOLOGIES, LLC AND SHOULD NOT BE USED WITHOUT WRITTEN PERMISSION															
DIMENSION UNITS mm		SCALE 1:1		CURRENT REV DESC:				 RAST 5 VERT HDR PA 66 HOUSING							
GENERAL TOLERANCES (UNLESS SPECIFIED)				EC NO: 746008											
ANGULAR TOL ± 2.0°		4 PLACES ±		3 PLACES ±		2 PLACES ± 0.1		1 PLACE ± 0.2		0 PLACES ±		DRWN: RAHULH3 2023/04/14 CHK'D: RAHULH3 2023/04/14 APPR: MRAMAKRISHNA 2023/04/14			
DRAFT WHERE APPLICABLE MUST REMAIN WITHIN DIMENSIONS				THIRD ANGLE PROJECTION		DRAWING		SERIES		MATERIAL NUMBER		CUSTOMER		SHEET NUMBER	
				A1-SIZE		91999		SEE SHEETS 2-18		GENERAL MARKET		5 OF 17			
INITIAL REVISION:				DOCUMENT NUMBER				DOC TYPE DOC PART REVISION							
DRWN: AKABADI 2017/09/15				919990001				PSD 000 L4							
APPR: BRUTTLE 2017/11/10															

3 CIRCUIT

SEE CODE DESIGNATION TABLE FOR NUMBERING
FORMAT WHEN ADDING NEW PART NUMBE

PART NO. (TIN)	TERM NO. (TIN)	MOLEX HOUSING NO.	COLOUR	UNBLOCKED POSITION KEYS	UNBLOCKED CODING KEYS	LATCH POSITION	CONFIGURATION (SEE NOTES)	TERMINAL VOID CKT	TERM NO. (SILVER)	PART NO. (SILVER)	P.C.B. POLARISATION OPTION	PACKAGING OPTION *	COLOUR STRIPE
91999-0537	91703-0017	93002-1000	NATURAL	1b	01c d20	1/2		NONE	91703-0018	91999-1229	C	A	NONE
91999-0538	91703-0017	93002-1009	NATURAL	2b 3b	d10 02c	2/3		NONE	91703-0018	91999-1228	C	A	NONE
91999-0539	91703-0002	93002-1000	NATURAL	1b	01c d20	1/2		NONE	91703-0003	91999-1227	B	A	NONE
91999-0540	91703-0002	93002-1009	NATURAL	2b 3b	d10 02c	2/3		NONE	91703-0003	91999-1226	B	A	NONE
91999-0541	91703-0002	93002-1019	NATURAL	2a	01c d30	1/2		NONE	91703-0003	91999-1225	A	A	NONE
91999-0542	91703-0002	93002-1020	NATURAL	3b	01c d30	1/2		NONE	91703-0003	91999-1224	A	A	NONE
91999-0543	91703-0002	93002-1022	NATURAL	1b 2a	NONE	1/2		NONE	91703-0003	91999-1223	A	A	NONE
91999-0544	91703-0002	93002-1030	NATURAL	1b 2a 2b 3b	NONE	2/3		NONE	91703-0003	91999-1222	A	A	NONE
91999-0545	91703-0002	93002-1025	NATURAL	1a 1b	d20	1/2		NONE	91703-0003	91999-1221	A	A	NONE
91999-0546	91703-0002	93002-1026	NATURAL	2a 3a	01c d20 03c	1/2		NONE	91703-0003	91999-1220	A	A	NONE
91999-0548	91703-0002	93002-1027	NATURAL	1a 3a	d30	2/3		NONE	91703-0003	91999-1218	A	A	NONE
91999-0549	91703-0002	93002-1028	NATURAL	ALL	01c d10 02c d30	2/3		NONE	91703-0003	91999-1217	A	A	NONE
91999-0550	91703-0017	93002-1029	NATURAL	2a	d10 02c d30	2/3		NONE	91703-0018	91999-1216	C	A	NONE
91999-0551	91703-0002	93002-1030	NATURAL	1b 2a 2b 3b	NONE	2/3		NONE	91703-0003	91999-1215	B	A	NONE
91999-0552	91703-0020	93002-1031	NATURAL	1b 2b	01c d20	1/2		NONE	91703-0021	91999-1214	A	A	NONE
91999-0553	91703-0017	93002-1014	NATURAL	ALL	ALL	1/2		NONE	91703-0018	91999-1213	C	A	NONE
91999-0554	91703-0002	93002-1032	NATURAL	1a 3a	03c	1/2		NONE	91703-0003	91999-1212	A	A	NONE
91999-0555	91703-0002	93002-1033	NATURAL	1b 2a 3b	01c d20	1/2		NONE	91703-0003	91999-1211	A	A	NONE

NOTES:
* SEE SHEET 1 NOTE 4

THIS DRAWING CONTAINS INFORMATION THAT IS PROPRIETARY TO MOLEX ELECTRONIC TECHNOLOGIES, LLC AND SHOULD NOT BE USED WITHOUT WRITTEN PERMISSION											
DIMENSION UNITS mm		SCALE 1:1		CURRENT REV DESC:				 RAST 5 VERT HDR PA 66 HOUSING			
GENERAL TOLERANCES (UNLESS SPECIFIED)				EC NO: 746008							
ANGULAR TOL ± 2.0°		4 PLACES ±		DRWN: RAHULH3		2023/04/10		PRODUCT CUSTOMER DRAWING DOCUMENT NUMBER: 919990001 DOC TYPE: PSD DOC PART: 000 REVISION: L4			
3 PLACES ±		2 PLACES ± 0.1		CHK'D: RAHULH3		2023/04/14					
2 PLACES ± 0.1		1 PLACE ± 0.2		APPR: MRAMAKRISHNA		2023/04/14					
1 PLACE ± 0.2		0 PLACES ±		INITIAL REVISION:				MATERIAL NUMBER: 91999 CUSTOMER: GENERAL MARKET SHEET NUMBER: 6 OF 17			
DRAFT WHERE APPLICABLE MUST REMAIN WITHIN DIMENSIONS				THIRD ANGLE PROJECTION		DRAWING 					

4 CIRCUIT

SEE CODE DESIGNATION TABLE FOR NUMBERING
FORMAT WHEN ADDING NEW PART NUMBE

PART NO. (TIN)	TERM NO. (TIN)	MOLEX HOUSING NO.	COLOUR	UNBLOCKED POSITION KEYS	UNBLOCKED CODING KEYS	LATCH POSITION	CONFIGURATION (SEE NOTES)	TERMINAL VOID CKT	TERM NO. (SILVER)	PART NO. (SILVER)	P.C.B. POLARISATION OPTION	PACKAGING OPTION *	COLOUR STRIPE
91999-1254	91703-0002	93002-2000	NATURAL	1b	03c d40	1/2 3/4		NONE	91703-0003	91999-1999	A	A	NONE
91999-1264	91703-0002	93002-2001	NATURAL	1a 4b	d40	1/2 3/4		NONE	91703-0003	91999-1998	A	A	NONE
91999-1265	91703-0002	93002-2002	NATURAL	2a 4b	d20	1/2 3/4		NONE	91703-0003	91999-1996	A	A	NONE
91999-1267	91703-0002	93002-2003	NATURAL	1b 2a 3a 4b	01c d40	1/2 3/4		NONE	91703-0003	91999-1994	A	A	NONE
91999-1270	91703-0002	93002-2004	NATURAL	1a 2b 4b	01c 03c d40	1/2 3/4		NONE	91703-0003	91999-1993	A	A	NONE
91999-1274	91703-0002	93002-2005	NATURAL	1a 3a 3b	01c d20 d40	1/2 3/4		NONE	91703-0003	91999-1992	A	A	NONE
91999-1275	91703-0002	93002-2006	NATURAL	1b 2a 4b	01c d20 03c	1/2 3/4		NONE	91703-0003	91999-1991	A	A	NONE
91999-1278	91703-0002	93002-2007	NATURAL	1a 3a	d40	1/2 3/4		NONE	91703-0003	91999-1987	A	A	NONE
91999-1280	91703-0002	93002-2008	NATURAL	1a 2b 3b 4a	01c 03c d40	1/2 3/4		NONE	91703-0003	91999-1988	A	A	NONE
91999-1281	91703-0002	93002-2009	NATURAL	2a 4b	d20 03c	1/2 3/4		NONE	91703-0003	91999-1986	A	A	NONE
91999-1282	91703-0002	93002-2010	NATURAL	3b	d30	2/3		NONE	91703-0003	91999-1985	A	A	NONE
91999-1283	91703-0002	93002-2011	NATURAL	1b 2a 4b	01c d20 03c d40	1/2 3/4		NONE	91703-0003	91999-1984	A	A	NONE
91999-1284	91703-0002	93002-2012	NATURAL	2a 3a 3b 4b	01c d20 03c d40	1/2 3/4		NONE	91703-0003	91999-1983	A	A	NONE
91999-1285	91703-0002	93002-2013	NATURAL	2a 2b 3b 4b	01c d20 03c d40	1/2 3/4		NONE	91703-0003	91999-1982	A	A	NONE
91999-1287	91703-0002	93002-2015	NATURAL	1a 4b	01c	1/2 3/4		NONE	91703-0003	91999-1980	A	A	NONE
91999-1288	91703-0002	93002-2016	NATURAL	1b 2b 3b 4a	01c 03c d40	1/2 3/4		NONE	91703-0003	91999-1979	A	A	NONE
91999-1289	91703-0017	93002-2000	NATURAL	1b	03c d40	1/2 3/4		NONE	91703-0018	91999-1978	C	A	NONE
91999-1290	91703-0002	93002-2017	NATURAL	1b 2a 2b 3a 4a 4b	03c d40	1/2 3/4		NONE	91703-0003	91999-1977	A	A	NONE
91999-1291	91703-0002	93002-2018	NATURAL	ALL	ALL	1/2 3/4		NONE	91703-0003	91999-1976	A	A	NONE

NOTES:
* SEE SHEET 1 NOTE 4

THIS DRAWING CONTAINS INFORMATION THAT IS PROPRIETARY TO MOLEX ELECTRONIC TECHNOLOGIES, LLC AND SHOULD NOT BE USED WITHOUT WRITTEN PERMISSION																					
DIMENSION UNITS mm		SCALE 1:1		CURRENT REV DESC:				 RAST 5 VERT HDR PA 66 HOUSING													
GENERAL TOLERANCES (UNLESS SPECIFIED)				EC NO: 746008 DRWN: RAHULH3 2023/04/10 CHK'D: RAHULH3 2023/04/14 APPR: MRAMAKRISHNA 2023/04/14																	
ANGULAR TOL ± 2.0°		4 PLACES ±		3 PLACES ±		2 PLACES ± 0.1		1 PLACE ± 0.2		0 PLACES ±		PRODUCT CUSTOMER DRAWING									
DRAFT WHERE APPLICABLE MUST REMAIN WITHIN DIMENSIONS				THIRD ANGLE PROJECTION		DRAWING 		SERIES A1-SIZE 91999		MATERIAL NUMBER SEE SHEETS 2-18		CUSTOMER GENERAL MARKET		DOCUMENT NUMBER 919990001		DOC TYPE PSD		DOC PART 000		REVISION L4	

4 CIRCUIT

SEE CODE DESIGNATION TABLE FOR NUMBERING
FORMAT WHEN ADDING NEW PART NUMBE

PART NO. (TIN)	TERM NO. (TIN)	MOLEX HOUSING NO.	COLOUR	UNBLOCKED POSITION KEYS	UNBLOCKED CODING KEYS	LATCH POSITION	CONFIGURATION (SEE NOTES)	TERMINAL VOID CKT	TERM NO. (SILVER)	PART NO. (SILVER)	P.C.B. POLARISATION OPTION	PACKAGING OPTION *	COLOUR STRIPE
91999-1292	91703-0002	93002-2019	NATURAL	1b 2a 3a 4a	01c d20 03c	1/2 3/4		NONE	91703-0003	91999-1975	A	A	NONE
91999-1293	91703-0002	93002-2020	NATURAL	1b 2b 3b 4a	01c 03c d40	1/2 3/4		NONE	91703-0003	91999-1974	A	A	NONE
91999-1294	91703-0002	93002-2021	NATURAL	1a 2a 2b 3a 3b 4a 4b	NONE	1/2 3/4		NONE	91703-0003	91999-1973	A	A	NONE
91999-1295	91703-0002	93002-2023	NATURAL	1b 3b 4b	01c d20 03c	1/2 3/4		NONE	91703-0003	91999-1972	A	A	NONE
91999-1296	91703-0002	93002-2000	NATURAL	1b	03c d40	1/2 3/4		NONE	91703-0003	91999-1971	B	A	NONE
91999-1297	91703-0002	93002-2015	NATURAL	1a 4b	01c	1/2 3/4		NONE	91703-0003	91999-1970	B	A	NONE
91999-1298	91703-0002	93002-2026	RED	1a 2a 4b	01c d20 03c d40	1/2 3/4		NONE	91703-0003	91999-1969	A	A	NONE
91999-1299	91703-0002	93002-2027	GREEN	2a 3a 3b 4b	01c d20 03c d40	1/2 3/4		NONE	91703-0003	91999-1968	A	A	NONE
91999-1300	91703-0002	93002-2001	NATURAL	1a 4b	d40	1/2 3/4		NONE	91703-0003	91999-1951	B	A	NONE
91999-1301	91703-0002	93002-2047	GREEN	1b	03c d40	1/2 3/4		NONE	91703-0003	91999-1950	A	A	NONE
91999-1255	91703-0002	93002-2033	NATURAL	1b 2a 3a 4b	01c d20 03c	1/2 3/4		NONE	91703-0003	91999-1963	A	A	NONE
91999-1256	91703-0002	93002-2034	NATURAL	1b 2b 3a 4b	01c d40	1/2 3/4		NONE	91703-0003	91999-1962	A	A	NONE
91999-1257	91703-0002	93002-2035	NATURAL	2a 2b 3a 4a	01c 03c	1/2 3/4		NONE	91703-0003	91999-1961	A	A	NONE
91999-1258	91703-0017	93002-2015	NATURAL	1a 4b	01c	1/2 3/4		NONE	91703-0018	91999-1960	C	A	NONE
91999-1259	91703-0017	93002-2010	NATURAL	3b	d30	2/3		NONE	91703-0018	91999-1959	C	A	NONE
91999-1260	91703-0017	93002-2011	NATURAL	1b 2a 4b	01c d20 03c d40	1/2 3/4		NONE	91703-0018	91999-1958	C	A	NONE
91999-1261	91703-0002	93002-2036	NATURAL	1b 2a 3a 3b 4b	01c d20 03c d40	1/2 3/4		NONE	91703-0003	91999-1957	A	A	NONE
91999-1262	91703-0002	93002-2000	NATURAL	1b	03c d40	1/2 3/4		CCT 3	91703-0003	91999-1956	A	A	NONE
91999-1263	91703-0002	93002-2037	NATURAL	1b 3b	d10 03c d40	3/4		NONE	91703-0003	91999-1955	A	A	NONE
91999-1266	91703-0002	93002-2038	NATURAL	2a 3b 4b	01c d20 03c d40	1/2 3/4		NONE	91703-0003	91999-1954	A	A	NONE

NOTES:

* SEE SHEET 1 NOTE 4

THIS DRAWING CONTAINS INFORMATION THAT IS PROPRIETARY TO MOLEX ELECTRONIC TECHNOLOGIES, LLC AND SHOULD NOT BE USED WITHOUT WRITTEN PERMISSION

DIMENSION UNITS mm	SCALE 1:1	CURRENT REV DESC:	molex				
GENERAL TOLERANCES (UNLESS SPECIFIED)							
ANGULAR TOL ± 2.0°	4 PLACES ±	EC NO: 746008 DRWN: RAHULH3 2023/04/10 CHK'D: RAHULH3 2023/04/14 APPR: MRAMAKRISHNA 2023/04/14	RAST 5 VERT HDR PA 66 HOUSING				
3 PLACES ±	2 PLACES ± 0.1		PRODUCT CUSTOMER DRAWING				
1 PLACE ± 0.2	0 PLACES ±	INITIAL REVISION: DRWN: AKABADI 2017/09/15 APPR: BRUTTLE 2017/11/10	DOCUMENT NUMBER	DOC TYPE	DOC PART	REVISION	
DRAFT WHERE APPLICABLE MUST REMAIN WITHIN DIMENSIONS			THIRD ANGLE PROJECTION	DRAWING	SERIES	MATERIAL NUMBER	CUSTOMER
			A1-SIZE	91999	919990001	PSD 000	L4
			SEE SHEETS 2-18	GENERAL MARKET	9 OF 17		

4 CIRCUIT

SEE CODE DESIGNATION TABLE FOR NUMBERING
FORMAT WHEN ADDING NEW PART NUMBE

PART NO. (TIN)	TERM NO. (TIN)	MOLEX HOUSING NO.	COLOUR	UNBLOCKED POSITION KEYS	UNBLOCKED CODING KEYS	LATCH POSITION	CONFIGURATION (SEE NOTES)	TERMINAL VOID CKT	TERM NO. (SILVER)	PART NO. (SILVER)	P.C.B. POLARISATION OPTION	PACKAGING OPTION *	COLOUR STRIPE
91999-1268	91703-0002	93002-2039	NATURAL	1b	01c d20 03c d40	1/2 3/4		NONE	91703-0003	91999-1953	A	A	NONE
91999-1269	91703-0017	93002-2002	NATURAL	2a 4b	d20	1/2 3/4		NONE	91703-0018	91999-1989	C	A	NONE
91999-1253	91703-0017	93002-2004	NATURAL	1a 2b 4b	01c 03c d40	1/2 3/4		NONE	91703-0018	91999-1952	C	A	NONE
91999-7000	91703-0002	93002-2999	NATURAL	1b 2b 3b 4a	01c 03c d40	1/2 3/4		NONE	91703-0003	91999-7500	A	A	NONE
91999-7001	91703-0002	93002-2040	NATURAL	1a 1b 2a 3b 4a 4b	01c 02c 03c d40	3/4		NONE	91703-0003	91999-7501	A	A	NONE
91999-7002	91703-0002	93002-2041	NATURAL	1a	01c d20 03c	1/2		NONE	91703-0003	91999-7502	A	A	NONE
91999-7003	91703-0002	93002-2042	NATURAL	2a 2b 3b 4a	01c 03c d40	1/2		NONE	91703-0003	91999-7503	A	A	NONE
91999-7004	91703-0017	93002-2036	NATURAL	1b 2a 3a 3b 4b	01c d20 03c d40	1/2 3/4		NONE	91703-0018	91999-7504	C	A	NONE
91999-7005	91703-0002	93002-2044	NATURAL	2a 3b	01c d40	1/2 3/4		NONE	91703-0003	91999-7505	A	A	NONE
91999-7006	91703-0002	93002-2046	NATURAL	1b 2a 3a 4b	d20 03c	1/2 3/4		NONE	91703-0003	91999-7506	A	A	NONE
91999-1279	91703-0002	93002-2028	NATURAL	1b 2a 4b	d20 03c d40	1/2 3/4		NONE	91703-0003	91999-1967	A	A	NONE
91999-1251	91703-0002	93002-2029	NATURAL	1a 3b 4a	01c d20 d40	1/2 3/4		NONE	91703-0003	91999-1966	A	A	NONE
91999-1252	91703-0002	93002-2030	NATURAL	1a 2b 3b 4a	d20 d40	1/2 3/4		NONE	91703-0003	91999-1965	A	A	NONE
91999-1302	91703-0002	93002-2000	NATURAL	1b	03c d40	1/2 3/4		CCT 3	91703-0003	91999-1952	B	A	NONE

NOTES:

* SEE SHEET 1 NOTE 4

THIS DRAWING CONTAINS INFORMATION THAT IS PROPRIETARY TO MOLEX ELECTRONIC TECHNOLOGIES, LLC AND SHOULD NOT BE USED WITHOUT WRITTEN PERMISSION									
DIMENSION UNITS	SCALE	CURRENT REV DESC:						molex	
mm	1:1								
GENERAL TOLERANCES (UNLESS SPECIFIED)		EC NO: 746008						RAST 5 VERT HDR PA 66 HOUSING	
ANGULAR TOL	± 2.0°	DRWN: RAHULH3 2023/04/14						PRODUCT CUSTOMER DRAWING	
4 PLACES	±	CHK'D: RAHULH3 2023/04/14						DOCUMENT NUMBER	
3 PLACES	±	APPR: MRAMAKRISHNA 2023/04/14						919990001	
2 PLACES	± 0.1	INITIAL REVISION:						DOC TYPE DOC PART REVISION	
1 PLACE	± 0.2	DRWN: AKABADI 2017/09/15						PSD 000 L4	
0 PLACES	±	APPR: BRUTTLE 2017/11/10							
DRAFT WHERE APPLICABLE MUST REMAIN WITHIN DIMENSIONS		THIRD ANGLE PROJECTION	DRAWING	SERIES	MATERIAL NUMBER	CUSTOMER	SHEET NUMBER		
			A1-SIZE	91999	SEE SHEETS 2-18	GENERAL MARKET	10 OF 17		

5 CIRCUIT

SEE CODE DESIGNATION TABLE FOR NUMBERING
FORMAT WHEN ADDING NEW PART NUMBE

PART NO. (TIN)	TERM NO. (TIN)	MOLEX HOUSING NO.	COLOUR	UNBLOCKED POSITION KEYS	UNBLOCKED CODING KEYS	LATCH POSITION	CONFIGURATION (SEE NOTES)	TERMINAL VOID CKT	TERM NO. (SILVER)	PART NO. (SILVER)	P.C.B. POLARISATION OPTION	PACKAGING OPTION *	COLOUR STRIPE
91999-2000	91703-0002	93002-3000	NATURAL	1a 5b	01c d30	1/2 2/3		NONE	91703-0003	91999-2749	A	A	NONE
91999-2001	91703-0002	93002-3001	NATURAL	1a 3a	01c d30	1/2 4/5		NONE	91703-0003	91999-2748	A	A	NONE
91999-2002	91703-0002	93002-3002	NATURAL	1a 5b	01c d20 03c d50	1/2 3/4		NONE	91703-0003	91999-2747	A	A	NONE
91999-2003	91703-0002	93002-3003	NATURAL	1b 2a 3b 5a	01c 03c	1/2 3/4		NONE	91703-0003	91999-2746	A	A	NONE
91999-2004	91703-0002	93002-3004	NATURAL	1a 2a 2b 4b 5b	01c d30 04c d50	1/2 2/3 4/5		NONE	91703-0003	91999-2745	A	A	NONE
91999-2006	91703-0002	93002-3005	NATURAL	2a	01c d50	2/3 4/5		NONE	91703-0003	91999-2742	A	A	NONE
91999-2012	91703-0002	93002-3006	NATURAL	2a 4b	01c d20 d40	1/2 3/4		NONE	91703-0003	91999-2743	A	A	NONE
91999-2013	91703-0002	93002-3007	NATURAL	2b	d20	1/2 4/5		NONE	91703-0003	91999-2741	A	A	NONE
91999-2014	91703-0002	93002-3008	NATURAL	4b 5a	01c d30 04c d50	1/2 4/5		NONE	91703-0003	91999-2740	A	A	NONE
91999-2015	91703-0002	93002-3009	NATURAL	NONE	01c d40	1/2 3/4		NONE	91703-0003	91999-2739	A	A	NONE
91999-2017	91703-0002	93002-3010	NATURAL	1a 4a	d30	1/2 4/5		NONE	91703-0003	91999-2737	A	A	NONE
91999-2024	91703-0002	93002-3011	NATURAL	1a 5b	d20 d40	1/2 3/4		NONE	91703-0003	91999-2732	A	A	NONE
91999-2025	91703-0002	93002-3019	NATURAL	2b	d20 d50	1/2 3/4		NONE	91703-0003	91999-2733	A	A	NONE
91999-2006	91703-0002	93002-3005	NATURAL	2a	01c d50	2/3 4/5		NONE	91703-0003	91999-2742	A	A	NONE
91999-2027	91703-0002	93002-3020	NATURAL	1a 3a 4b 5a	03c 04c	1/2 4/5		NONE	91703-0003	91999-2735	A	A	NONE
91999-2029	91703-0002	93002-3016	NATURAL	1b 2a 4a	01c 04c d50	1/2 4/5		NONE	91703-0003	91999-2730	A	A	NONE
91999-2030	91703-0002	93002-3017	NATURAL	2b 3b 4a	01c d20 d40	1/2 3/4		NONE	91703-0003	91999-2729	A	A	NONE
91999-2031	91703-0002	93002-3022	NATURAL	1a 5b	01c d20 03c d50	1/2 4/5		NONE	91703-0003	91999-2728	A	A	NONE
91999-2032	91703-0002	93002-3023	NATURAL	1a 1b 4a	d30 04c d50	1/2 4/5		NONE	91703-0003	91999-2727	A	A	NONE

NOTES:
* SEE SHEET 1 NOTE 4

THIS DRAWING CONTAINS INFORMATION THAT IS PROPRIETARY TO MOLEX ELECTRONIC TECHNOLOGIES, LLC AND SHOULD NOT BE USED WITHOUT WRITTEN PERMISSION													
DIMENSION UNITS mm		SCALE 1:1		CURRENT REV DESC:				 RAST 5 VERT HDR PA 66 HOUSING					
GENERAL TOLERANCES (UNLESS SPECIFIED)				EC NO: 746008									
ANGULAR TOL ± 2.0°		4 PLACES ±		DRWN: RAHULH3		2023/04/10		PRODUCT CUSTOMER DRAWING					
3 PLACES ±		2 PLACES ± 0.1		CHK'D: RAHULH3		2023/04/14		DOCUMENT NUMBER					
1 PLACE ± 0.2		0 PLACES ±		APPR: MRAMAKRISHNA		2023/04/14		DOC TYPE DOC PART REVISION					
INITIAL REVISION:				DRWN: AKABADI				919990001					
DRAFT WHERE APPLICABLE MUST REMAIN WITHIN DIMENSIONS				THIRD ANGLE PROJECTION		DRAWING		SERIES		CUSTOMER		SHEET NUMBER	
						A1-SIZE		91999		SEE SHEETS 2-18		GENERAL MARKET	
DOCUMENT STATUS				P1		RELEASE DATE		2023/04/14		14:04:31		11 OF 17	

5 CIRCUIT

SEE CODE DESIGNATION TABLE FOR NUMBERING
FORMAT WHEN ADDING NEW PART NUMBE

PART NO. (TIN)	TERM NO. (TIN)	MOLEX HOUSING NO.	COLOUR	UNBLOCKED POSITION KEYS	UNBLOCKED CODING KEYS	LATCH POSITION	CONFIGURATION (SEE NOTES)	TERMINAL VOID CKT	TERM NO. (SILVER)	PART NO. (SILVER)	P.C.B. POLARISATION OPTION	PACKAGING OPTION *	COLOUR STRIPE
91999-2033	91703-0002	93002-3002	NATURAL	1a 5b	01c d20 03c d50	1/2 3/4		NONE	91703-0003	91999-2726	B	A	NONE
91999-2034	91703-0017	93002-3001	NATURAL	1a 3a	01c d30	1/2 4/5		NONE	91703-0018	91999-2725	C	A	NONE
91999-2035	91703-0002	93002-3024	NATURAL	ALL	ALL	1/2 3/4		NONE	91703-0003	91999-2724	A	A	NONE
91999-2036	91703-0017	93002-3000	NATURAL	1a 5b	01c d30	1/2 2/3		NONE	91703-0018	91999-2723	C	A	NONE
91999-2038	91703-0002	93002-3000	NATURAL	1a 5b	01c d30	1/2 2/3		NONE	91703-0003	91999-2721	B	A	NONE
91999-2039	91703-0017	93002-3003	NATURAL	1b 2a 3b 5a	01c 03c	1/2 3/4		NONE	91703-0018	91999-2720	C	A	NONE
91999-2040	91703-0002	93002-3003	NATURAL	1b 2a 3b 5a	01c 03c	1/2 3/4		NONE	91703-0003	91999-2719	B	A	NONE
91999-2041	91703-0002	93002-3026	NATURAL	2a 2b 3b 4a	d20 d40	1/2 3/4		NONE	91703-0003	91999-2718	A	A	NONE
91999-2042	91703-0017	93002-3002	NATURAL	1a 5b	01c d20 03c d50	1/2 3/4		NONE	91703-0018	91999-2717	C	A	NONE
91999-2043	91703-0002	93002-3029	NATURAL	1b 3b 4b	01c d20 d50	1/2 4/5		2,4	91703-0003	91999-2716	A	A	NONE
91999-2044	91703-0002	93002-3007	NATURAL	2b	d20	1/2 4/5		4	91703-0003	91999-2715	A	A	NONE
91999-2045	91703-0002	93002-3030	NATURAL	1a 2b 4b	03c d50	1/2 4/5		NONE	91703-0003	91999-2714	A	A	NONE
91999-2046	91703-0002	93002-3031	NATURAL	2b	d20	1/2		2,4	91703-0003	91999-2713	A	A	NONE
----	91703-0002	93002-3022	NATURAL	1a 5b	01c d20 03c d50	1/2 4/5		2,4	91703-0003	91999-2712	A	A	NONE
91999-2048	91703-0002	93002-3022	NATURAL	1a 5b	01c d20 03c d50	1/2 4/5		2,4	91703-0003	91999-2711	B	A	NONE
91999-2049	91703-0002	93002-3007	NATURAL	2b	d20	1/2 4/5		2,4	91703-0003	91999-2710	B	A	NONE
91999-2050	91703-0002	93002-3020	NATURAL	1a 3a 4b 5a	03c 04c	1/2 4/5		4	91703-0003	91999-2709	A	A	NONE
91999-2051	91703-0002	93002-3006	NATURAL	2a 4b	01c d20 d40	1/2 3/4		NONE	91703-0003	91999-2708	B	A	NONE
91999-2052	91703-0002	93002-3006	NATURAL	2a 4b	01c d20 d40	1/2 3/4		4	91703-0003	91999-2708	A	A	NONE

NOTES:
* SEE SHEET 1 NOTE 4

THIS DRAWING CONTAINS INFORMATION THAT IS PROPRIETARY TO MOLEX ELECTRONIC TECHNOLOGIES, LLC AND SHOULD NOT BE USED WITHOUT WRITTEN PERMISSION											
DIMENSION UNITS mm		SCALE 1:1		CURRENT REV DESC:				 RAST 5 VERT HDR PA 66 HOUSING			
GENERAL TOLERANCES (UNLESS SPECIFIED)				EC NO: 746008							
ANGULAR TOL ± 2.0°		4 PLACES ±		DRWN: RAHULH3		2023/04/10		PRODUCT CUSTOMER DRAWING DOCUMENT NUMBER: 919990001 DOC TYPE: PSD DOC PART: 000 REVISION: L4			
3 PLACES ±		2 PLACES ± 0.1		CHK'D: RAHULH3		2023/04/14					
1 PLACE ± 0.2		0 PLACES ±		APPR: MRAMAKRISHNA		2023/04/14		INITIAL REVISION: DRWN: AKABADI 2017/09/15 APPR: BRUTTLE 2017/11/10			
DRAFT WHERE APPLICABLE MUST REMAIN WITHIN DIMENSIONS		THIRD ANGLE PROJECTION		DRAWING		SERIES					
				A1-SIZE		91999		MATERIAL NUMBER: SEE SHEETS 2-18 CUSTOMER: GENERAL MARKET SHEET NUMBER: 12 OF 17			

6 CIRCUIT

SEE CODE DESIGNATION TABLE FOR NUMBERING
FORMAT WHEN ADDING NEW PART NUMBE

PART NO. (TIN)	TERM NO. (TIN)	MOLEX HOUSING NO.	COLOUR	UNBLOCKED POSITION KEYS	UNBLOCKED CODING KEYS	LATCH POSITION	CONFIGURATION (SEE NOTES)	TERMINAL VOID CKT	TERM NO. (SILVER)	PART NO. (SILVER)	P.C.B. POLARISATION OPTION	PACKAGING OPTION *	COLOUR STRIPE
91999-2753	91703-0002	93002-4000	NATURAL	1b	03c d60	1/2 4/5		NONE	91703-0003	91999-3499	A	A	NONE
91999-2754	91703-0002	93002-4001	NATURAL	1a 3b 4b	01c d50 06c	1/2 4/5		NONE	91703-0003	91999-3498	A	A	NONE
91999-2755	91703-0002	93002-4002	NATURAL	1a 1b 2b 3a 3b 4b	d30 04c d50	1/2 2/3 4/5		NONE	91703-0003	91999-3497	A	A	NONE
91999-2756	91703-0002	93002-4003	NATURAL	1a 1b 4a 4b	d10 d50	2/3 4/5		NONE	91703-0003	91999-3496	A	A	NONE
91999-2757	91703-0002	93002-4004	NATURAL	2a 4b 5a 6b	d20 03c 05c	1/2 3/4 5/6		NONE	91703-0003	91999-3495	A	A	NONE
91999-2758	91703-0002	93002-4005	NATURAL	1a 2b 3a 3b 5b 6b	01c d40 d60	1/2 3/4 5/6		NONE	91703-0003	91999-3494	A	A	NONE
91999-2759	91703-0002	93002-4006	NATURAL	1b 2a 3a 4b 5a 5b 6b	01c 03c d60	1/2 3/4 5/6		NONE	91703-0003	91999-3493	A	A	NONE
91999-2761	91703-0002	93002-4007	NATURAL	2b	d20 d60	1/2 5/6		NONE	91703-0003	91999-3492	A	A	NONE
91999-2762	91703-0002	93002-4008	NATURAL	2b 3b 4a	01c d50 06c	1/2 4/5		NONE	91703-0003	91999-3491	A	A	NONE
91999-2768	91703-0002	93002-4009	NATURAL	1b 4b	d20 03c d50 06c	1/2 4/5		NONE	91703-0003	91999-3486	A	A	NONE
91999-2769	91703-0002	93002-4010	NATURAL	1a 2b 3b 4a 6b	01c 03c d40 05c d60	1/2 3/4 5/6		NONE	91703-0003	91999-3485	A	A	NONE
91999-2770	91703-0002	93002-4011	NATURAL	1a 2b 4a 6b	01c d40	1/2 3/4 5/6		NONE	91703-0003	91999-3484	A	A	NONE
91999-2771	91703-0002	93002-4030	NATURAL	1b 6b	d40	1/2 5/6		2 & 5	91703-0003	91999-3483	A	A	NONE
91999-2772	91703-0002	93002-4016	NATURAL	1b 2a 3a 4b 5a 5b 6b	01c d60	2/3 5/6		NONE	91703-0003	91999-3482	A	A	NONE
91999-2773	91703-0017	93002-4000	NATURAL	1b	03c d60	1/2 4/5		NONE	91703-0018	91999-3481	C	A	NONE
91999-2774	91703-0017	93002-4017	NATURAL	1a 1b 2b 3b	d20 05c d60	1/2 3/4 5/6		NONE	91703-0018	91999-3480	C	A	NONE
91999-2775	91703-0017	93002-4016	NATURAL	1b 2a 3a 4b 5a 5b 6b	01c d60	2/3 5/6		NONE	91703-0018	91999-3479	C	A	NONE
91999-2776	91703-0002	93002-4018	NATURAL	ALL	ALL	1/2 4/5		NONE	91703-0003	91999-3478	A	A	NONE
91999-2777	91703-0002	93002-4019	NATURAL	1b	03c d60	1/2 5/6		NONE	91703-0003	91999-3477	A	A	NONE
91999-2778	91703-0002	93002-4020	NATURAL	1b 2b 3b	01c 05c d60	1/2 3/4 5/6		NONE	91703-0003	91999-3476	A	A	NONE

NOTES:
* SEE SHEET 1 NOTE 4

THIS DRAWING CONTAINS INFORMATION THAT IS PROPRIETARY TO MOLEX ELECTRONIC TECHNOLOGIES, LLC AND SHOULD NOT BE USED WITHOUT WRITTEN PERMISSION													
DIMENSION UNITS		SCALE		CURRENT REV DESC:								molex	
mm		1:1											
GENERAL TOLERANCES (UNLESS SPECIFIED)				EC NO: 746008								RAST 5 VERT HDR PA 66 HOUSING	
ANGULAR TOL ± 2.0°				DRWN: RAHULH3 2023/04/10								PRODUCT CUSTOMER DRAWING	
4 PLACES ±				CHK'D: RAHULH3 2023/04/14								DOCUMENT NUMBER	
3 PLACES ±				APPR: MRAMAKRISHNA 2023/04/14								DOC TYPE DOC PART REVISION	
2 PLACES ± 0.1				INITIAL REVISION:								919990001	
1 PLACE ± 0.2				DRWN: AKABADI 2017/09/15								PSD 000 L4	
0 PLACES ±				APPR: BRUTTLE 2017/11/10								MATERIAL NUMBER CUSTOMER SHEET NUMBER	
DRAFT WHERE APPLICABLE MUST REMAIN WITHIN DIMENSIONS				THIRD ANGLE PROJECTION		DRAWING		SERIES		SEE SHEETS 2-18			
						A1-SIZE		91999		GENERAL MARKET 13 OF 17			

6 CIRCUIT

SEE CODE DESIGNATION TABLE FOR NUMBERING
FORMAT WHEN ADDING NEW PART

PART NO. (TIN)	TERM NO. (TIN)	MOLEX HOUSING NO.	COLOUR	UNBLOCKED POSITION KEYS	UNBLOCKED CODING KEYS	LATCH POSITION	CONFIGURATION (SEE NOTES)	TERMINAL VOID CKT	TERM NO. (SILVER)	PART NO. (SILVER)	P.C.B. POLARISATION OPTION	PACKAGING OPTION *	COLOUR STRIPE
91999-2779	91703-0002	93002-4021	NATURAL	ALL	ALL	2/3 4/5		NONE	91703-0003	91999-3475	A	A	NONE
91999-2780	91703-0002	93002-4023	NATURAL	1b 6a	04c	1/2 5/6		NONE	91703-0003	91999-3474	A	A	NONE
91999-2781	91703-0017	93002-4000	NATURAL	1b	03c d60	1/2 4/5		NONE	91703-0018	91999-3473	C	A	NONE
91999-2782	91703-0002	93002-4022	NATURAL	1b 2a 2b 3a 3b 6a	ALL	4/5		NONE	91703-0003	91999-3472	A	A	NONE
91999-2783	91703-0002	93002-4025	NATURAL	1b 2a 3a 4b 5b 6a 6b	01c d20 03c d60	1/2 3/4 5/6		NONE	91703-0003	91999-3471	A	A	NONE
91999-2784	91703-0002	93002-4012	NATURAL	2b 6b	d40	1/2 5/6		NONE	91703-0003	91999-3470	A	A	NONE
91999-2785	91703-0002	93002-4026	NATURAL	1a 1b 2a 2b 3a 3b 6a	01c d10 02c d30 d50 06c	4/5		NONE	91703-0003	91999-3469	A	A	NONE
91999-2786	91703-0002	93002-4000	NATURAL	1b	03c d60	1/2 4/5		2	91703-0003	91999-3468	A	A	NONE
91999-2787	91703-0002	93002-4027	NATURAL	1a 1b 2a 2b 3a 3b 5b 6b	01c d20 03c d30 04c 05c d60	1/2 5/6		NONE	91703-0003	91999-3467	A	A	NONE
91999-2788	91703-0002	93002-4028	NATURAL	1b 5b 6a	d20 03c d40 05c	1/2 3/4 5/6		NONE	91703-0003	91999-3487	A	A	NONE
91999-2789	91703-0002	93002-4000	NATURAL	1b	03c d60	1/2 4/5		NONE	91703-0003	91999-3490	B	A	NONE

NOTES:

* SEE SHEET 1 NOTE 4

THIS DRAWING CONTAINS INFORMATION THAT IS PROPRIETARY TO MOLEX ELECTRONIC TECHNOLOGIES, LLC AND SHOULD NOT BE USED WITHOUT WRITTEN PERMISSION															
DIMENSION UNITS mm		SCALE 1:1		CURRENT REV DESC:											
GENERAL TOLERANCES (UNLESS SPECIFIED)															
ANGULAR TOL ± 2.0°		4 PLACES ±		3 PLACES ±		2 PLACES ± 0.1		1 PLACE ± 0.2		0 PLACES ±					
EC NO: 746008				DRWN: RAHULH3 2023/04/10				RAST 5 VERT HDR PA 66 HOUSING							
CHK'D: RAHULH3 2023/04/14				APPR: MRAMAKRISHNA 2023/04/14											
INITIAL REVISION:				DRWN: AKABADI 2017/09/15				PRODUCT CUSTOMER DRAWING							
APPR: BRUTTLE 2017/11/10				DOCUMENT NUMBER				DOC TYPE DOC PART REVISION							
DRAFT WHERE APPLICABLE MUST REMAIN WITHIN DIMENSIONS				THIRD ANGLE PROJECTION		DRAWING		SERIES		MATERIAL NUMBER		CUSTOMER		SHEET NUMBER	
				A1-SIZE		91999		919990001		PSD 000		L4			
SEE SHEETS 2-18				GENERAL MARKET				14 OF 17							

7 CIRCUIT

SEE CODE DESIGNATION TABLE FOR NUMBERING
FORMAT WHEN ADDING NEW PART NUMBE

PART NO. (TIN)	TERM NO. (TIN)	MOLEX HOUSING NO.	COLOUR	UNBLOCKED POSITION KEYS	UNBLOCKED CODING KEYS	LATCH POSITION	CONFIGURATION (SEE NOTES)	TERMINAL VOID CKT	TERM NO. (SILVER)	PART NO. (SILVER)	P.C.B. POLARISATION OPTION	PACKAGING OPTION *	COLOUR STRIPE
91999-3511	91703-0002	93002-5000	NATURAL	NONE	03c d40 07c	1/2 5/6		NONE	91703-0003	91999-4249	A	A	NONE
91999-3512	91703-0002	93002-5001	NATURAL	3a 4a	d30 d70	1/2 5/6		NONE	91703-0003	91999-4248	A	A	NONE
91999-3504	91703-0002	93002-5002	NATURAL	2b	d20 d60	1/2 5/6		NONE	91703-0003	91999-4247	A	A	NONE
91999-3508	91703-0002	93002-5003	NATURAL	1a 1b 3a 4b 5a	01c 07c	1/2 3/4 5/6		NONE	91703-0003	91999-4243	A	A	NONE
91999-3509	91703-0002	93002-5004	NATURAL	2a	01c d50	2/3 4/5		NONE	91703-0003	91999-4242	A	A	NONE
91999-3515	91703-0002	93002-5005	NATURAL	7b	01c d40 d70	1/2 3/4 6/7		NONE	91703-0003	91999-4240	A	A	NONE
91999-3516	91703-0002	93002-5006	NATURAL	1b	03c d60	1/2 4/5		NONE	91703-0003	91999-4239	A	A	NONE
91999-3517	91703-0002	93002-5007	NATURAL	1a 3a 4b 7b	01c d20 03c 06c	1/2 3/4 6/7		NONE	91703-0003	91999-4238	A	A	NONE
91999-3519	91703-0002	93002-5008	NATURAL	1b 7a	02c d50	2/3 6/7		NONE	91703-0003	91999-4237	A	A	NONE
91999-3521	91703-0002	93002-5009	NATURAL	1a 2b 3a 4b 6a	d20 03c d40 d50 d70	1/2 3/4 6/7		NONE	91703-0003	91999-4236	A	A	NONE
91999-3522	91703-0002	93002-5010	NATURAL	1b 6a	d20 03c d50 d70	1/2 3/4 6/7		NONE	91703-0003	91999-4235	A	A	NONE
91999-3523	91703-0002	93002-5011	NATURAL	1b 2a 5a 5b 7b	d20 d50 06c d70	1/2 4/5 6/7		NONE	91703-0003	91999-4234	A	A	NONE
91999-3524	91703-0002	93002-5012	NATURAL	2b	d20 07c	1/2 3/4 5/6		NONE	91703-0003	91999-4233	A	A	NONE
91999-3525	91703-0002	93002-5013	NATURAL	2a 2b 4b 5b 6a	d20 03c d40 d60	1/2 3/4 5/6		NONE	91703-0003	91999-4232	A	A	NONE
91999-3526	91703-0002	93002-5014	NATURAL	2b 4a 4b 5b 6a	01c d20 d40 d60	1/2 3/4 5/6		NONE	91703-0003	91999-4231	A	A	NONE
91999-3527	91703-0002	93002-5015	NATURAL	1b 2a 3a 5b 6a 6b 7b	01c d70	2/3 6/7		NONE	91703-0003	91999-4230	A	A	NONE
91999-3528	91703-0002	93002-5016	NATURAL	ALL	ALL	1/2 5/6		NONE	91703-0003	91999-4229	A	A	NONE
91999-3529	91703-0002	93002-5017	NATURAL	2a 3b 4b 5a 6a 6b 7a	01c d30 04c 06c d60 d70	1/2 4/5		NONE	91703-0003	91999-4228	A	A	NONE
91999-3530	91703-0002	93002-5018	NATURAL	NONE	04c 07c	1/2 5/6		NONE	91703-0003	91999-4227	A	A	NONE
91999-3531	91703-0017	93002-5000	NATURAL	NONE	03c d40 07c	1/2 5/6		NONE	91703-0018	91999-4226	C	A	NONE

NOTES:
* SEE SHEET 1 NOTE 4

THIS DRAWING CONTAINS INFORMATION THAT IS PROPRIETARY TO MOLEX ELECTRONIC TECHNOLOGIES, LLC AND SHOULD NOT BE USED WITHOUT WRITTEN PERMISSION															
DIMENSION UNITS mm		SCALE 1:1		CURRENT REV DESC:				 RAST 5 VERT HDR PA 66 HOUSING							
GENERAL TOLERANCES (UNLESS SPECIFIED)				EC NO: 746008 DRWN: RAHULH3 2023/04/10 CHK'D: RAHULH3 2023/04/14 APPR: MRAMAKRISHNA 2023/04/14											
ANGULAR TOL ± 2.0°		4 PLACES ±		3 PLACES ±		2 PLACES ± 0.1		1 PLACE ± 0.2		0 PLACES ±		PRODUCT CUSTOMER DRAWING			
DRAFT WHERE APPLICABLE MUST REMAIN WITHIN DIMENSIONS				THIRD ANGLE PROJECTION		DRAWING 		SERIES A1-SIZE 91999		MATERIAL NUMBER SEE SHEETS 2-18		CUSTOMER GENERAL MARKET		SHEET NUMBER 15 OF 17	
DOCUMENT STATUS P1 RELEASE DATE 2023/04/14 14:04:31				INITIAL REVISION: DRWN: AKABADI 2017/09/15 APPR: BRUTTLE 2017/11/10				DOCUMENT NUMBER 919990001		DOC TYPE PSD		DOC PART 000		REVISION L4	

7 CIRCUIT

SEE CODE DESIGNATION TABLE FOR NUMBERING
FORMAT WHEN ADDING NEW PART NUMBE

PART NO. (TIN)	TERM NO. (TIN)	MOLEX HOUSING NO.	COLOUR	UNBLOCKED POSITION KEYS	UNBLOCKED CODING KEYS	LATCH POSITION	CONFIGURATION (SEE NOTES)	TERMINAL VOID CKT	TERM NO. (SILVER)	PART NO. (SILVER)	P.C.B. POLARISATION OPTION	PACKAGING OPTION *	COLOUR STRIPE
91999-3532	91703-0002	93002-5021	NATURAL	5b	d30 d70	1/2 6/7		NONE	91703-0003	91999-4225	A	A	NONE
91999-3533	91703-0002	93002-5022	NATURAL	1a 1b 2b 3a 4b 6a	d10 d30 04c d40 d50 d70	2/3 6/7		NONE	91703-0003	91999-4224	A	A	NONE
91999-3534	91703-0002	93002-5023	NATURAL	1b 2b 3a 4a 7b	d20 03c d70	1/2 3/4 4/5 6/7		NONE	91703-0003	91999-4223	A	A	NONE
91999-3535	91703-0002	93002-5021	NATURAL	5b	d30 d70	1/2 6/7		2, 4 & 6	91703-0003	91999-4222	A	A	NONE
91999-3536	91703-0002	93002-5001	NATURAL	3a 4a	d30 d70	1/2 5/6		NONE	91703-0003	91999-4221	A	A	NONE
91999-3537	91703-0002	93002-5021	NATURAL	5b	d30 d70	1/2 6/7		2, 4 & 6	91703-0003	91999-4220	B	A	NONE
91999-3538	91703-0002	93002-5001	NATURAL	3a 4a	d30 d70	1/2 5/6		2, 4 & 6	91703-0003	91999-4219	B	A	NONE
91999-3539	91703-0002	93002-5000	NATURAL	NONE	03c d40 07c	1/2 5/6		NONE	91703-0003	91999-4218	B	A	NONE
91999-3540	91703-0002	93002-5025	NATURAL	5b	d30 d70	2/3 5/6		2, 4 & 6	91703-0003	91999-4217	B	A	NONE

NOTES:
* SEE SHEET 1 NOTE 4

THIS DRAWING CONTAINS INFORMATION THAT IS PROPRIETARY TO MOLEX ELECTRONIC TECHNOLOGIES, LLC AND SHOULD NOT BE USED WITHOUT WRITTEN PERMISSION											
DIMENSION UNITS	SCALE	CURRENT REV DESC:									
mm	1:1										
GENERAL TOLERANCES (UNLESS SPECIFIED)		EC NO: 746008 DRWN: RAHULH3 2023/04/10 CHK'D: RAHULH3 2023/04/14 APPR: MRAMAKRISHNA 2023/04/14 INITIAL REVISION: DRWN: AKABADI 2017/09/15 APPR: BRUTTLE 2017/11/10					RAST 5 VERT HDR PA 66 HOUSING				
ANGULAR TOL	± 2.0°						PRODUCT CUSTOMER DRAWING				
4 PLACES	±						DOCUMENT NUMBER		DOC TYPE	DOC PART	REVISION
3 PLACES	±						919990001		PSD	000	L4
2 PLACES	± 0.1						MATERIAL NUMBER		CUSTOMER		SHEET NUMBER
1 PLACE	± 0.2						SEE SHEETS 2-18		GENERAL MARKET		16 OF 17
0 PLACES	±	DRAFT WHERE APPLICABLE MUST REMAIN WITHIN DIMENSIONS		THIRD ANGLE PROJECTION	DRAWING	SERIES					
		A1-SIZE		91999							

8 CIRCUIT

SEE CODE DESIGNATION TABLE FOR NUMBERING
FORMAT WHEN ADDING NEW PART NUMBE

PART NO. (TIN)	TERM NO. (TIN)	MOLEX HOUSING NO.	COLOUR	UNBLOCKED POSITION KEYS	UNBLOCKED CODING KEYS	LATCH POSITION	CONFIGURATION (SEE NOTES)	TERMINAL VOID CKT	TERM NO. (SILVER)	PART NO. (SILVER)	P.C.B. POLARISATION OPTION	PACKAGING OPTION *	COLOUR STRIPE
91999-4250	91703-0002	93002-6010	NATURAL	8b	01c d10 04c d40 05c d50 06c d60 07c d70 08c d80	2/3		NONE	91703-0003	91999-4999	A	A	NONE
91999-4251	91703-0002	93002-6011	NATURAL	1a 4b 5a 6b 7b 8a	d40 d60 07c d80	1/2 3/4 5/6 7/8		NONE	91703-0003	91999-4998	A	A	NONE
91999-4252	91703-0002	93002-6012	NATURAL	ALL	d20 03c d60 07c	1/2 7/8		2, 4 & 6	91703-0003	91999-4997	A	A	NONE
91999-4253	91703-0002	93002-6013	NATURAL	1a 2a 3a 4b 5a 5b 6b 7b 8b	01c 03c d60 07c	1/2 3/4 5/6 7/8		NONE	91703-0003	91999-4996	A	A	NONE
91999-4254	91703-0002	93002-6012	NATURAL	ALL	d20 03c d60 07c	1/2 7/8		NONE	91703-0003	91999-4995	A	A	NONE

NOTES:

* SEE SHEET 1 NOTE 4

THIS DRAWING CONTAINS INFORMATION THAT IS PROPRIETARY TO MOLEX ELECTRONIC TECHNOLOGIES, LLC AND SHOULD NOT BE USED WITHOUT WRITTEN PERMISSION															
DIMENSION UNITS		SCALE		CURRENT REV DESC:											
mm		1:1													
GENERAL TOLERANCES (UNLESS SPECIFIED)				EC NO: 746008 DRWN: RAHULH3 2023/04/10 CHK'D: RAHULH3 2023/04/14 APPR: MRAMAKRISHNA 2023/04/14 INITIAL REVISION: DRWN: AKABADI 2017/09/15 APPR: BRUTTLE 2017/11/10				RAST 5 VERT HDR PA 66 HOUSING							
ANGULAR TOL ± 2.0°								PRODUCT CUSTOMER DRAWING							
4 PLACES ±								DOCUMENT NUMBER		DOC TYPE		DOC PART		REVISION	
3 PLACES ±								919990001		PSD		000		L4	
2 PLACES ± 0.1								MATERIAL NUMBER		CUSTOMER		SHEET NUMBER			
1 PLACE ± 0.2								SEE SHEETS 2-18		GENERAL MARKET		17 OF 17			
0 PLACES ±				DRAFT WHERE APPLICABLE MUST REMAIN WITHIN DIMENSIONS		THIRD ANGLE PROJECTION		DRAWING		SERIES					
						A1-SIZE		91999							