



QUAD 2-INPUT MULTIPLEXER WITH 3-STATE OUTPUTS

The MC74F257 is a quad 2-input multiplexer with 3-state outputs. Four bits of data from two sources can be selected using a common Data Select input. The four outputs present the selected data in true (non-inverted) form. The outputs may be switched to a high impedance state with a HIGH on the common Output Enable (OE) input, allowing the outputs to interface directly with bus oriented systems.

- Multiplexer Expansion by Tying Outputs Together
- Non-Inverting 3-State Outputs
- Input Clamp Diodes Limit High-Speed Termination Effects
- AC Enhanced Version of the F257

CONNECTION DIAGRAM

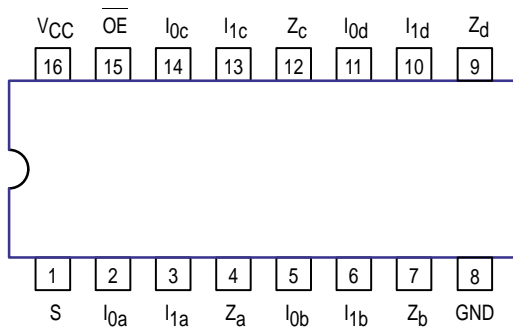

LOGIC DIAGRAM

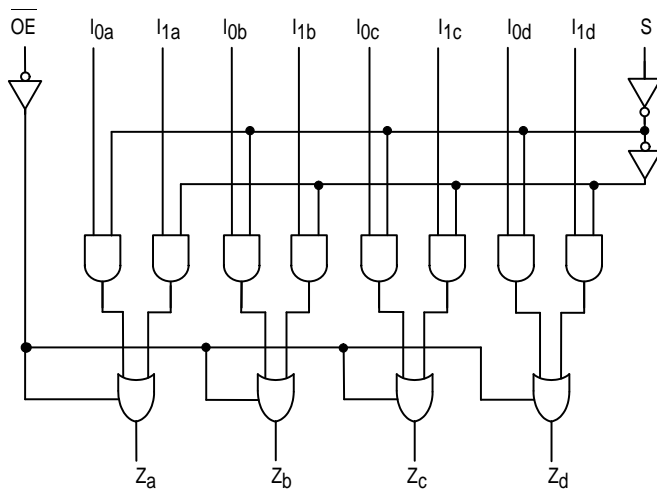

FUNCTION TABLE

Output Enable	Select Input	Data Inputs		Outputs
OE	S	I ₀	I ₁	Z
H	X	X	X	Z
L	H	X	L	L
L	H	X	H	H
L	L	L	X	L
L	L	H	X	H

H = HIGH Voltage Level
 L = LOW Voltage Level
 X = Don't Care
 Z = High Impedance

MC74F257A

QUAD 2-INPUT MULTIPLEXER WITH 3-STATE OUTPUTS

FAST™ SCHOTTKY TTL

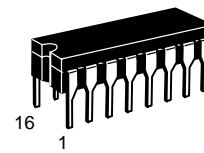

J SUFFIX
 CERAMIC
 CASE 620-09

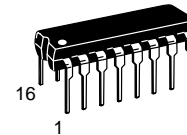

N SUFFIX
 PLASTIC
 CASE 648-08

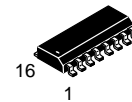

D SUFFIX
 SOIC
 CASE 751B-03

ORDERING INFORMATION

MC54FXXXAJ Ceramic
 MC74FXXXAN Plastic
 MC74FXXXAD SOIC

LOGIC SYMBOL

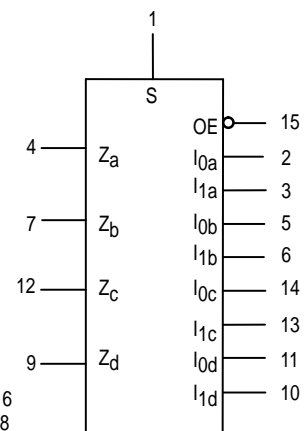

VCC = PIN 16
 GND = PIN 8

LIFETIME BUY

LAST SHIP 30/09/99
 LAST ORDER 31/03/99

MC74F257A

GUARANTEED OPERATING RANGES

Symbol	Parameter		Min	Typ	Max	Unit
V _{CC}	Supply Voltage	74	4.5	5.0	5.5	V
T _A	Operating Ambient Temperature Range	74	0	25	70	°C
I _{OH}	Output Current — High	74			-3.0	mA
I _{OL}	Output Current — Low	74			24	mA

DC CHARACTERISTICS OVER OPERATING TEMPERATURE RANGE (unless otherwise specified)

Symbol	Parameter	Limits			Unit	Test Conditions	
		Min	Typ	Max			
V _{IH}	Input HIGH Voltage	2.0			V	Guaranteed Input HIGH Voltage	
V _{IL}	Input LOW Voltage			0.8	V	Guaranteed Input LOW Voltage	
V _{IK}	Input Clamp Diode Voltage			-1.2	V	I _{IN} = -18 mA	V _{CC} = MIN
V _{OH}	Output HIGH Voltage	74	2.4	3.3	V	I _{OH} = -3.0 mA	V _{CC} = 4.50 V
		74	2.7	3.3	V	I _{OH} = -3.0 mA	V _{CC} = 4.75 V
V _{OL}	Output LOW Voltage		0.35	0.5	V	I _{OL} = 24 mA	V _{CC} = MIN
I _{OZH}	Output OFF Current — HIGH			50	μA	V _{OUT} = 2.7 V	V _{CC} = MAX
I _{OZL}	Output OFF Current — LOW			-50	μA	V _{OUT} = 0.5 V	V _{CC} = MAX
I _{IH}	Input HIGH Current			20	μA	V _{IN} = 2.7 V	V _{CC} = MAX
				100		V _{IN} = 7.0 V	
I _{IL}	Input LOW Current			-0.6	mA	V _{IN} = 0.5 V	V _{CC} = MAX
I _{OS}	Output Short Circuit Current (Note 2)	-60		-150	mA	V _{OUT} = 0 V	V _{CC} = MAX
I _{CCH}	Power Supply Current		9.0	15	mA	S, I _{1x} = 4.5 V OE, I _{0x} = GND	V _{CC} = MAX
I _{CCL}			14.5	22		I _{1x} = 4.5 V OE, I _{0x} , S = GND	
I _{CCZ}			15	23		S, I _{0x} = GND OE, I _{1x} = 4.5 V	

NOTES:

- For conditions shown as MIN or MAX, use the appropriate value specified under guaranteed operating ranges.
- Not more than one output should be shorted at a time, nor for more than 1 second.

FUNCTIONAL DESCRIPTION

The F257A is a quad 2-input multiplexer with 3-state outputs. It selects four bits of data from two sources under control of a Common Data Select input. When the Select input is LOW, the I_{0x} inputs are selected and when Select is HIGH, the I_{1x} inputs are selected. The data on the selected inputs appears at the outputs in true (non-inverted) form. The device is the logic implementation of a 4-pole, 2-position switch where the position of the switch is determined by the logic levels supplied to the Select input. The logic equations for the outputs are shown below:

$$Z_a = \overline{OE} \cdot (I_{1a} \cdot S + I_{0a} \cdot \overline{S})$$

$$Z_b = \overline{OE} \cdot (I_{1b} \cdot S + I_{0b} \cdot \overline{S})$$

$$Z_c = \overline{OE} \cdot (I_{1c} \cdot S + I_{0c} \cdot \overline{S})$$

$$Z_d = \overline{OE} \cdot (I_{1d} \cdot S + I_{0d} \cdot \overline{S})$$

When the Output Enable input (OE) is HIGH, the outputs are forced to a high impedance OFF state. If the outputs are tied together, all but one device must be in the high impedance state to avoid high currents that would exceed the maximum ratings. Designers should ensure the Output Enable signals to 3-state devices whose outputs are tied together are designed so there is no overlap.

MC74F257A

AC CHARACTERISTICS

Symbol	Parameter	74F		74F		Unit
		T _A = +25°C V _{CC} = +5.0 V C _L = 50 pF		T _A = 0°C to 70°C V _{CC} = 5.0 V ± 10% C _L = 50 pF		
		Min	Max	Min	Max	
t _{PLH}	Propagation Delay	1.5	5.5	1.5	6.0	ns
t _{PHL}	I _n to Z _n	2.0	5.5	2.0	6.0	
t _{PLH}	Propagation Delay	3.0	9.5	3.0	10.5	ns
t _{PHL}	S to Z _n	2.5	7.0	2.5	8.0	
t _{PZH}	Output Enable Time	2.0	6.5	2.0	7.0	ns
t _{PZL}		2.5	7.0	2.5	8.0	
t _{PHZ}	Output Disable Time	2.0	6.0	2.0	7.0	ns
t _{PLZ}		2.0	6.0	2.0	7.0	

LIFETIME BUY

LAST SHIP 30/09/99
LAST ORDER 31/03/99

LIFETIME BUY

LAST ORDER 31/03/99 LAST SHIP 30/09/99

Mfax is a trademark of Motorola, Inc.

Motorola reserves the right to make changes without further notice to any products herein. Motorola makes no warranty, representation or guarantee regarding the suitability of its products for any particular purpose, nor does Motorola assume any liability arising out of the application or use of any product or circuit, and specifically disclaims any and all liability, including without limitation consequential or incidental damages. "Typical" parameters which may be provided in Motorola data sheets and/or specifications can and do vary in different applications and actual performance may vary over time. All operating parameters, including "Typicals" must be validated for each customer application by customer's technical experts. Motorola does not convey any license under its patent rights nor the rights of others. Motorola products are not designed, intended, or authorized for use as components in systems intended for surgical implant into the body, or other applications intended to support or sustain life, or for any other application in which the failure of the Motorola product could create a situation where personal injury or death may occur. Should Buyer purchase or use Motorola products for any such unintended or unauthorized application, Buyer shall indemnify and hold Motorola and its officers, employees, subsidiaries, affiliates, and distributors harmless against all claims, costs, damages, and expenses, and reasonable attorney fees arising out of, directly or indirectly, any claim of personal injury or death associated with such unintended or unauthorized use, even if such claim alleges that Motorola was negligent regarding the design or manufacture of the part. Motorola and  are registered trademarks of Motorola, Inc. Motorola, Inc. is an Equal Opportunity/Affirmative Action Employer.

How to reach us:

USA/EUROPE/Locations Not Listed: Motorola Literature Distribution; P.O. Box 5405, Denver, Colorado 80217.
1-303-675-2140 or 1-800-441-2447

JAPAN: Motorola Japan Ltd.; SPS, Technical Information Center, 3-20-1, Minami-Azabu. Minato-ku, Tokyo 106-8573 Japan.
81-3-3440-3569

ASIA/PACIFIC: Motorola Semiconductors H.K. Ltd.; Silicon Harbour Centre, 2 Dai King Street, Tai Po Industrial Estate, Tai Po, N.T., Hong Kong. 852-26668334

Customer Focus Center: 1-800-521-6274

Mfax™: RMFAX0@email.sps.mot.com – TOUCHTONE 1-602-244-6609
Motorola Fax Back System – US & Canada ONLY 1-800-774-1848
– <http://sps.motorola.com/mfax/>

HOME PAGE: <http://motorola.com/sps/>

