

## **DIX4192EVM-PDK User's Guide**

---



---

This user's guide provides a reference document for the DIX4192EVM-PDK product development kit. The kit includes a DIX4192EVM daughterboard as well as a DAIMB motherboard. Together, the daughter and mother boards form a modular platform for evaluating the function and performance of the Texas Instruments' DIX4192 integrated circuit. Applications software is provided with the PDK for writing and reading registers and data buffers integral to the DIX4192 device. The software communicates with the device under test using the USB slave interface on the DAIMB board. The software requires a host PC running the Microsoft Windows™ 2000 or XP operating system.

Throughout this document, the acronym *EVM* and the phrase *evaluation module* are synonymous with the DIX4192EVM. The acronym *PDK* refers to the daughterboard EVM and DAIMB motherboard combination. This document includes information regarding absolute operating conditions, hardware configuration, and software installation and operation. Complete electrical schematics and a bill of materials for both the EVM and the DAIMB boards are also included.

### **Contents**

|   |  |    |
|---|--|----|
| 1 | Introduction .....                                   | 2  |
| 2 | Quick Start.....                                     | 3  |
| 3 | Software Overview, Installation, and Operation ..... | 9  |
| 4 | Hardware Reference.....                              | 14 |

### **List of Figures**

|   |   |    |
|---|---|----|
| 1 | Illustration of the PDK Platform Utilizing a DAIMB Motherboard and a Daughterboard EVM .....  | 2  |
| 2 | Power-Supply Jumper Configuration (DAIMB Motherboard) .....                                   | 5  |
| 3 | PDK Power, Host, and Input/Output Connections .....   | 8  |
| 4 | Applications Software Window (USB Serial Commander).....                                      | 10 |
| 5 | Example of a Readback Display and Break Message in the USB Serial Commander Application ..... | 12 |
| 6 | Electrical Schematic: DIX4192EVM Daughterboard.....   | 15 |
| 7 | Electrical Schematic: DAIMB Motherboard, Page 1 .....   | 16 |
| 8 | Electrical Schematic: DAIMB Motherboard, Page 2.....  | 17 |

### **List of Tables**

|   |   |   |
|---|---|---|
| 1 | Absolute Operating Conditions .....   | 4 |
| 2 | Jumper JMP2 Configuration (EVM Daughterboard) .....                           | 5 |
| 3 | Jumper JMP3 Configuration (EVM Daughterboard) .....                           | 5 |
| 4 | Jumper JMP4 Configuration (EVM Daughterboard) .....                           | 5 |
| 5 | Jumper JMP1, RX4 Input Selection (EVM Daughterboard).....                     | 6 |
| 6 | Audio Serial Port Slave/Master Switch Configuration (DAIMB Motherboard) ..... | 6 |
| 7 | USB SPI Port Configuration (DAIMB Motherboard) .....                          | 6 |

I<sup>2</sup>C, I<sup>2</sup>S are trademarks of Koninklijke Philips Electronics N.V.  
 Windows is a trademark of Microsoft Corporation.  
 SPI is a trademark of Motorola, Inc.  
 NI-VISA is a trademark of National Instruments.  
 TOSLINK is a trademark of Toshiba Corporation.  
 WinZip is a trademark of WinZip International, LLC.  
 All other trademarks are the property of their respective owners.

|    |   |    |
|----|---|----|
| 8  | MCLK1 Clock Source Selection (DAIMB Daughterboard) .....                    | 7  |
| 9  | MCLK2 Clock Source Selection (DAIMB Daughterboard) .....                    | 7  |
| 10 | DIX4192 Control Port Mode Configuration (EVM Daughterboard).....            | 7  |
| 11 | I <sup>2</sup> C 7-Bit Slave Address Configuration (EVM Daughterboard)..... | 8  |
| 12 | SPI Command Syntax .....  | 12 |
| 13 | I <sup>2</sup> C Command Syntax.....  | 13 |
| 14 | Bill of Materials for the DIX4192EVM .....                                  | 18 |
| 15 | Bill of Materials for the DAIMB .....                                       | 19 |

## 1 Introduction

The DIX4192EVM-PDK provides a modular solution for evaluating the function and performance of the DIX4192 device from Texas Instruments. The PDK includes a motherboard (the DAIMB) and a daughterboard (the EVM). [Figure 1](#) depicts the modular platform concept, with the EVM plugged into the DAIMB board. Connectors are indicated and labeled for ease of identification.

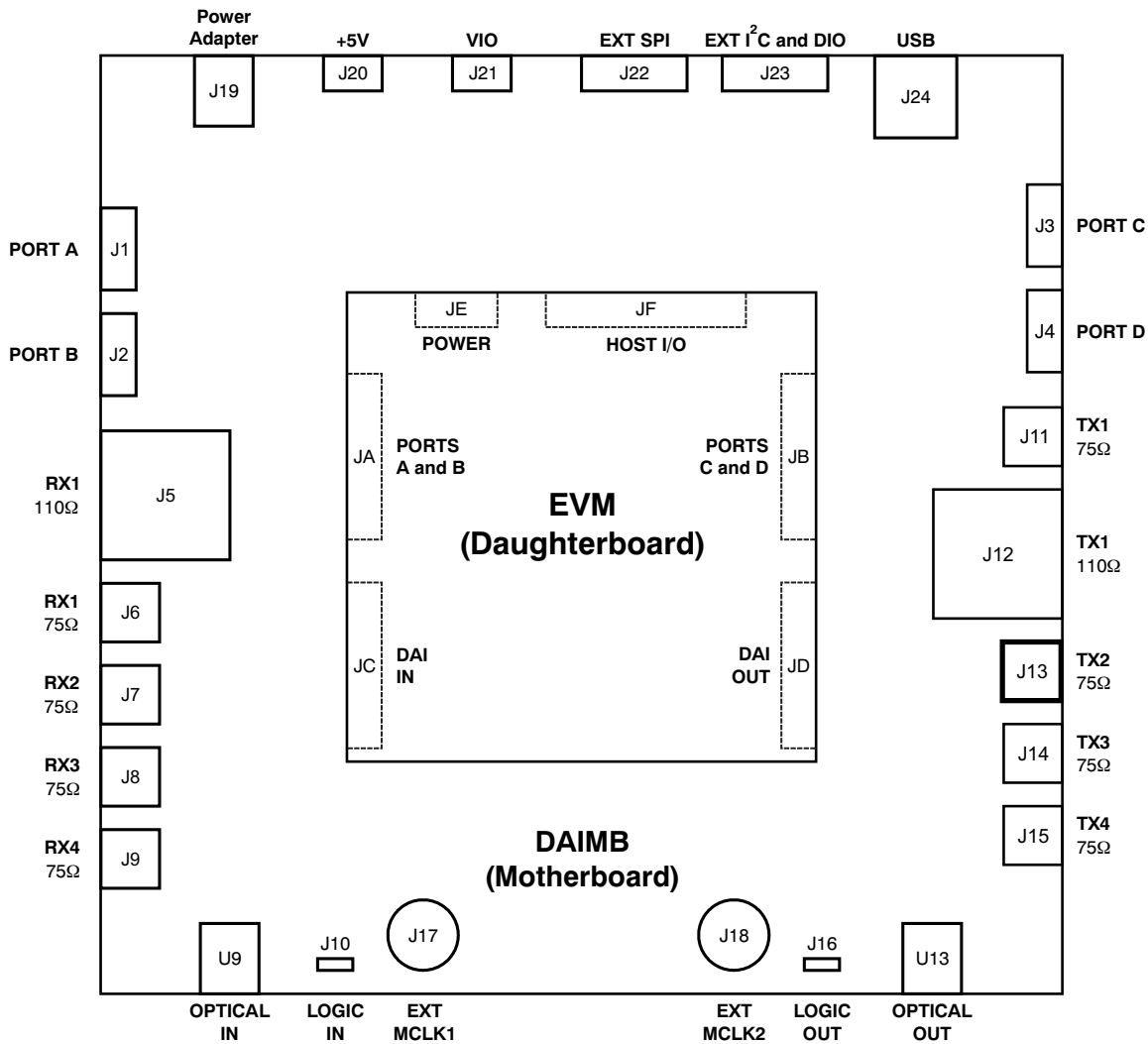

Figure 1. Illustration of the PDK Platform Utilizing a DAIMB Motherboard and a Daughterboard EVM

The modular design allows for common functions to be integrated onto the DAIMB motherboard, while device-specific functions are integrated onto the daughterboard EVM. The modular platform supports a variety of digital audio interface devices by simply replacing the daughterboard EVM shipped with the product-specific PDK. Texas Instruments products supported by this modular platform include digital audio interface receivers, transmitters, transceivers, and combination SRC/transceiver products.

The primary features of the DIX4192EVM-PDK include:

- A USB slave interface, implemented with a Texas Instruments [TAS1020B USB controller](#), and supported by computers running Microsoft Windows 2000 or XP. The USB interface supports bus or self-powered operation, and communicates with the EVM daughterboard via an SPI™ or I<sup>2</sup>C™ interface.
- Buffered headers support up to four audio serial port interfaces, compatible with I<sup>2</sup>S™-style or time-division multiplexed (TDM) data formats. Only two of these ports are utilized for the DIX4192EVM.
- Six digital audio input ports support AES3-balanced inputs, S/PDIF coaxial and optical sources, and CMOS logic level inputs.
- Six digital audio output ports support AES3-balanced, S/PDIF coaxial and optical, and CMOS logic level outputs. Three of the ports are utilized for the DIX4192EVM.
- Flexible reference and master clock generation are supported, using either onboard oscillators or external clock sources.
- Power may be provided from a wall adapter (included), or an external +5V regulated power supply. An optional external logic I/O (or VIO) supply connection is also supported.
- Onboard linear regulators derive +1.8V, +3.3V, and +5V power supplies from the supplied power adapter, external supplies, and/or the USB bus connection.
- An LED indicator is provided for the DIR Lock output flag.
- Applications software provides functions for writing and reading the on-chip registers and data buffers. The applications software is compatible with personal computers with at least one USB 1.x or 2.0 port and running the Microsoft Windows 2000 or XP operating systems.

## 2 Quick Start

This section provides information regarding handling, package contents, and the absolute operating conditions for the DIX4192EVM-PDK.

### 2.1 *Electrostatic Discharge Warning*

#### **WARNING**

**Failure to observe proper ESD handling precautions may result in damage to EVM components.**

Many of the components used in the assembly of the PDK are susceptible to damage by electrostatic discharge (ESD). Customers are advised to observe proper ESD handling procedure when unpacking and handling the PDK components. All handling should be performed at an approved ESD workstation or test bench, using a grounded wrist strap. Failure to observe proper handling procedure may result in damage to EVM components.

## 2.2 Product Development Kit (PDK) Package Contents

The DIX4192EVM is included as part of a complete evaluation module package, referred to as a Product Development Kit (PDK). Each PDK package includes:

- One DIX4192EVM board.
- One DAIMB board.
- One printed copy of this DIX4192EVM-PDK User's Guide.
- One printed copy of the [DIX4192](#) datasheet.
- One power supply for powering the PDK.
- One USB cable (Type A to Type B male plugs).
- One CD-ROM containing the EVM applications software, support files, and documentation.

## 2.3 Absolute Operating Conditions

**CAUTION**

Exceeding the absolute operating conditions may result in improper EVM operation or damage to the evaluation module and/or the equipment connected to it.

The user should be aware of the absolute operating conditions for the PDK. [Table 1](#) summarizes these conditions.

**Table 1. Absolute Operating Conditions**

|  | Min  | Max   | Units           |
|--|------|-------|-----------------|
| <b>Power Supplies</b>                                |      |       |                 |
| Power Adapter (J19)                                  | +6.0 | +10.0 | VDC             |
| EXT +5V (J20)  | -0.3 | +5.5  | VDC             |
| EXT VIO  | -0.3 | +3.6  | VDC             |
| <b>Digital Input Voltage Range</b>                   |      |       |                 |
| Daughterboard Connectors (JA-JD,JF)                  | -0.3 | +3.6  | V               |
| PORT A through PORT D (J1-J4)                        | -0.3 | +3.6  | V               |
| EXT SPI and EXT I <sup>2</sup> C & DIO (J22 and J23) | -0.3 | +3.6  | V               |
| RX1 Balanced Input (J5), measured differentially     | —    | 7.2   | V <sub>PP</sub> |
| RX1 Unbalanced Input (J6)                            | —    | 3.6   | V <sub>PP</sub> |
| RX2 through RX4 (J7-J9)                              | —    | 3.6   | V <sub>PP</sub> |
| EXT MCLK1 and EXT MCLK2 (J17 and J18)                | -0.3 | +3.6  | V               |
| LOGIC INPUT (J10)                                    | -0.3 | +5.5  | V               |
| <b>PDK Operating Temperature</b>                     | 0    | +70   | °C              |

## 2.4 Jumper Configuration

This subsection provides an overview of the required jumper configuration for both the DAIMB motherboard and EVM daughterboard. Refer to the electrical schematics included in [Section 4](#) of this document for connection details, as well as jumper functions that may not be discussed in this section.

### 2.4.1 Power-Supply Jumpers

Power-supply configuration for the PDK is enabled using jumpers JMP1 through JMP3, located on the DAIMB motherboard. Figure 2 illustrates the options for each of these jumpers.

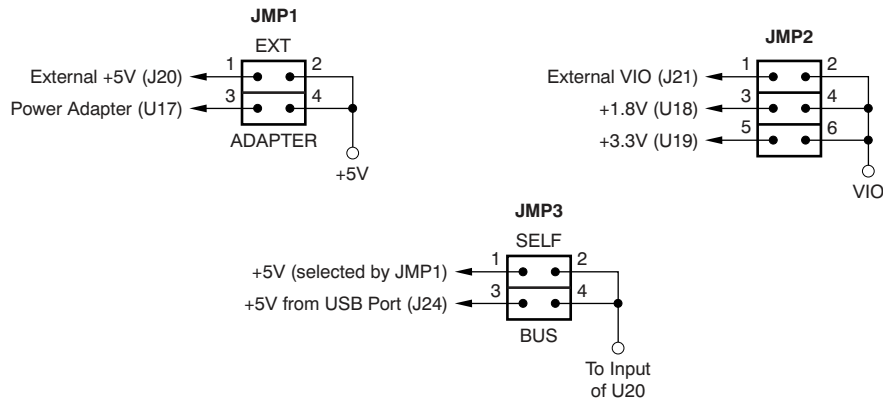

**Figure 2. Power-Supply Jumper Configuration (DAIMB Motherboard)**

By default, jumper JMP1 is configured for Power Adapter input at J19, jumper JMP2 is set up for a +3.3V logic I/O (or VIO) supply, and jumper JMP3 is set up for Bus power operation (+5V from connector J24). The +3.3V logic I/O supply is required in this case to maintain logic level compatibility with the USB slave interface circuitry.

Jumpers JMP5 through JMP8 on the EVM daughterboard are provided for measuring power-supply current. By default, these jumpers are shorted with bus wire, soldered during assembly of the board.

### 2.4.2 SPI and I<sup>2</sup>C Jumpers

Jumpers JMP2 through JMP4, located on the EVM daughterboard, are utilized to select SPI or I<sup>2</sup>C host interface connections for the DIX4192EVM. Refer to Table 2 through Table 4 for jumper configuration.

**Table 2. Jumper JMP2 Configuration (EVM Daughterboard)**

| JMP2 Pins 1–2 | JMP2 Pins 3–4 | Host Interface Selection |
|---------------|---------------|--------------------------|
| OPEN          | SHORT         | SPI                      |
| SHORT         | OPEN          | I <sup>2</sup> C         |

**Table 3. Jumper JMP3 Configuration (EVM Daughterboard)**

| JMP3 Pins 1–2 | JMP3 Pins 3–4 | Host Interface Selection |
|---------------|---------------|--------------------------|
| OPEN          | SHORT         | SPI                      |
| SHORT         | OPEN          | I <sup>2</sup> C         |

**Table 4. Jumper JMP4 Configuration (EVM Daughterboard)**

| JMP4 Pins 1-2 | JMP4 Pins 3-4 | Host Interface Selection |
|---------------|---------------|--------------------------|
| OPEN          | OPEN          | SPI                      |
| SHORT         | SHORT         | I <sup>2</sup> C         |

### 2.4.3 RX4 Receiver Input Jumper

Jumper JMP1, located on the EVM daughterboard, is used to select the input source for the RX4 line receiver inputs. Selection options are shown in [Table 5](#).

**Table 5. Jumper JMP1, RX4 Input Selection (EVM Daughterboard)**

| JMP1 Pins<br>1-2 | JMP1 Pins<br>3-4 | JMP1 Pins<br>5-6 | JMP1 Pins<br>7-8 | RX4 Input Source                              |
|------------------|------------------|------------------|------------------|---|
| SHORT            | SHORT            | OPEN             | OPEN             | RX4 Unbalanced 75Ω Input (DAIMB connector J9) |
| OPEN             | SHORT            | SHORT            | OPEN             | Optical Input Receiver (DAIMB U9)             |
| OPEN             | SHORT            | OPEN             | SHORT            | Logic Level Input (DAIMB header J10)          |

## 2.5 Switch Configuration

This subsection provides an overview of the DIP switch configuration for both the DAIMB motherboard and EVM daughterboard.

### 2.5.1 Audio Serial Port Slave/Master Configuration

The audio serial ports for the DIX4192 may operate in either Slave or Master mode. Switches SW1 and SW2 must be configured to match the programmed register configurations for the Port A and Port B audio serial ports on the DIX4192.

Port A of the DIX4192 is connected to Port D (or header J4) on the DAIMB motherboard, while Port B is connected to Port B (or header J2) on the motherboard. Switch SW1 must be set to match the Port B slave/master configuration, while switch SW2 must be set to match the Port A slave/master configuration. Switch configuration is summarized in [Table 6](#), where  $x = B$  for Port B, and  $x = D$  for Port A.

**Table 6. Audio Serial Port Slave/Master Switch Configuration (DAIMB Motherboard)**

| Switch SW1 or SW2, x_S/M | Port Configuration |
|--------------------------|--------------------|
| LO                       | Master             |
| HI                       | Slave              |

### 2.5.2 USB Serial Peripheral Interface (SPI) Port Configuration

#### CAUTION

When the I<sup>2</sup>C bus is utilized for host communications, the  $\overline{\text{USBSP1}}$  switch must be set to HI.

For the DAIMB motherboard, the  $\overline{\text{USBSP1}}$  switch on SW5 is utilized to enable or disable the tri-state buffers for the USB controller SPI port connections. [Table 7](#) summarizes the  $\overline{\text{USBSP1}}$  switch settings.

**Table 7. USB SPI Port Configuration (DAIMB Motherboard)**

| Switch SW5, $\overline{\text{USBSP1}}$ | USB-Based SPI Interface  |
|--|--|
| LO                                     | Enabled; the SPI port may be utilized for DIX4192 host communications. |
| HI                                     | Disabled; the SPI port outputs are set to a high-impedance state.      |

When the USB controller SPI interface is disabled, an external SPI host may be connected via header J22. Refer to the DAIMB electrical schematics in [Section 4](#) of this document for the header pin configuration.

### 2.5.3 MCLK1 and MCLK2 Clock Configuration

The DAIMB board supports both onboard and external clock generation for two clocks, referred to as *MCLK1* and *MCLK2*. The MCLK1 clock source is buffered and routed to the RXCKI input (pin 13) of the DIX4192 on the EVM daughterboard. The MCLK2 source is buffered and routed to the MCLK input (pin 25) of the DIX4192 on the EVM daughterboard.

Switch SW3 selects the clock source for the MCLK1 (that is, RXCKI) clock, while SW4 selects the clock source for MCLK2 (that is, MCLK). [Table 8](#) and [Table 9](#) summarize the SW3 and SW4 switch settings.

**Table 8. MCLK1 Clock Source Selection (DAIMB Daughterboard)**

| Switch SW3,<br>OSC2 | Switch SW3,<br>OSC1 | MCLK1 (or RXCKI) Source Selection                                   |
|---------------------|---------------------|---|
| LO                  | LO                  | External clock source at BNC connector J17 (X1 and X2 are disabled) |
| LO                  | HI                  | Oscillator X1, 24.576MHz $\pm$ 50ppm                                |
| HI                  | LO                  | Oscillator X2, 22.5792MHz $\pm$ 50ppm                               |
| HI                  | HI                  | Not allowed due to Oscillator X1 and X2 output contention.          |

**Table 9. MCLK2 Clock Source Selection (DAIMB Daughterboard)**

| Switch SW4,<br>OSC4 | Switch SW4,<br>OSC3 | MCLK2 (or MCLK) Source Selection                                    |
|---------------------|---------------------|---|
| LO                  | LO                  | External clock source at BNC connector J18 (X3 and X4 are disabled) |
| LO                  | HI                  | Oscillator X3, 24.576MHz $\pm$ 50ppm                                |
| HI                  | LO                  | Oscillator X4, 22.5792MHz $\pm$ 50ppm                               |
| HI                  | HI                  | Not allowed due to Oscillator X3 and X4 output contention.          |

### 2.5.4 Host Interface Configuration

For the EVM daughterboard, DIP switch SW1 is utilized to manually select the DIX4192 control port mode via the CPM input (pin 18). Bits A0 and A1 for the DIX4192 I<sup>2</sup>C slave address may also be configured using this switch. [Table 10](#) and [Table 11](#) summarize the operation of the SW1 switches.

**Table 10. DIX4192 Control Port Mode Configuration (EVM Daughterboard)**

| Switch SW1, CPM | SPI or I <sup>2</sup> C |
|-----------------|-------------------------|
| LO              | SPI                     |
| HI              | I <sup>2</sup> C        |

**Table 11. I<sup>2</sup>C 7-Bit Slave Address Configuration (EVM Daughterboard)**

| Switch SW1, A1 | Switch SW1, A0 | 7-Bit Slave Address (Binary) | Slave Address for Command Files (Hex) |
|----------------|----------------|------------------------------|---------------------------------------|
| LO             | LO             | 1110000                      | E0                                    |
| LO             | HI             | 1110001                      | E2                                    |
| HI             | LO             | 1110010                      | E4                                    |
| HI             | HI             | 1110011                      | E6                                    |

## 2.6 Audio, Power, and Logic I/O Connections

Figure 3 illustrates the power, USB, and primary audio input/output connections for the PDK. Headers J2 and J4 provide access to the DIX4192 audio serial ports, Port A (J4) and Port B (J2), as well as the DIR recovered clock output, RXCKO (pin 12). The pin assignments for the headers are also shown in Figure 3. Connectors J5 through J9, as well as optical receiver U9, provide the inputs for AES3 and S/PDIF digital audio sources. Connectors J11 and J12, along with optical transmitter U13, provide the AES3-encoded digital outputs for connection to external audio systems and test equipment. The J17 and J18 BNC connectors allow connection to external clock sources when the onboard oscillators are disabled. General-purpose outputs, as well as the DIT block start (BLS) and DIT internal frame synchronization (SYNC) clocks, are made available at header J23. The power adapter provided with the PDK is connected to the DAIMB motherboard at power jack J19. The host PC is connected to the PDK via the supplied USB cable, with connector J24 providing access to the DAIMB motherboard USB slave interface.

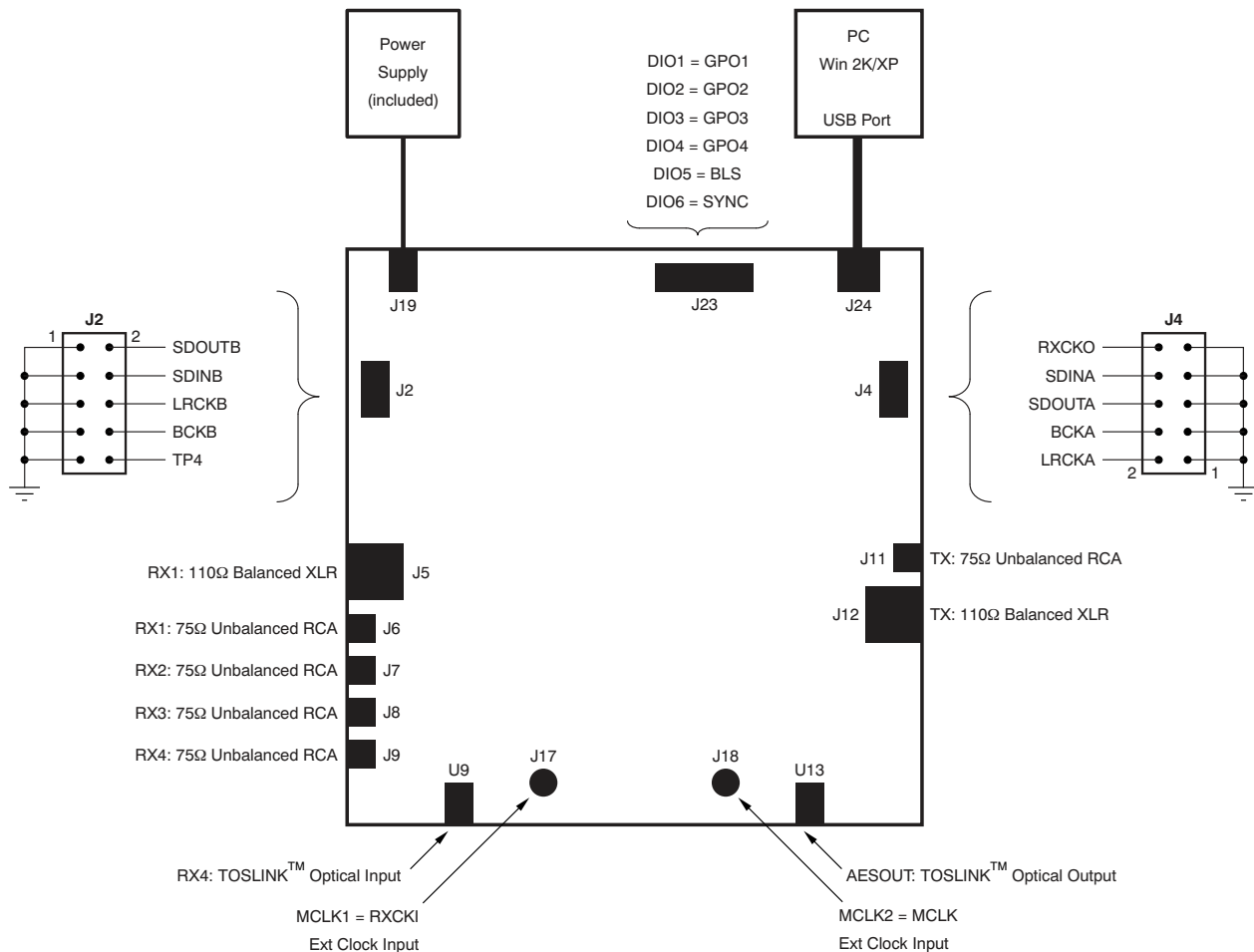

**Figure 3. PDK Power, Host, and Input/Output Connections**



### 3 Software Overview, Installation, and Operation

This section provides a discussion of the applications software that accompanies the PDK, including system requirements, installation procedures, and software operating instructions.

#### 3.1 Overview

The applications software provided with the PDK allows the user to program and read the contents of DIX4192 control and status registers, as well as the channel status and user data buffers for both the DIR and DIT. The software is referred to as the *USB Serial Commander*, and is a product of Texas Instruments (portions of the software are copyright by National Instruments). Refer to the End Users License Agreement included with the software.

#### 3.2 System Requirements

The applications software functions on computers that run the Microsoft Windows 2000 or XP operating systems, and include at least one available USB 1.x or USB 2.0 port. A CD-ROM drive is also required for software installation. A minimum of 256MB of system RAM is required, while 512MB of system RAM is recommended. Installation of the applications software requires a minimum of 50MB of free hard disk space.

#### 3.3 Installation Procedure

The following steps are required to install the USB Serial Commander Software. It is assumed that the user is familiar with the Windows 2000 or XP operating system, including window and menu navigation.

**Step 1:** Insert the accompanying CD-ROM into the PC CD-ROM drive.

**Step 2:** Go to the folder named *usc\_installer* on the CD-ROM. Open the folder and double-click on the file named *setup.exe*. Follow the instructions and prompts given by the installer program.

**Step 3:** When the main installation is complete, a dialog box will come up informing you about installing NI-VISA™ 3.1 Runtime. This file is a self-extracting archive. Click *OK* to proceed. You will then be presented with a WinZip™ dialog. Simply click *Unzip*; the archive self-extracts and automatically runs the NI-VISA 3.1 Runtime installer.

**Step 4:** Follow the instructions in the NI-VISA 3.1 Runtime Installer. When prompted for which features to install, do the following:

1. Click on the disk icon next to NI-VISA 3.1.
2. Select, **Do not install this feature.**
3. Click on the disk icon next to USB.
4. Select the option that installs this feature.
5. Click *Next*.

**Step 5:** Accept the license agreement, and continue the installation.

**Step 6:** When this completes, click *Finish* on the USB Serial Commander installer window.

**Step 7:** Restart your computer.

**Step 8:** When your computer is restarted, connect the DIX4192EVM-PDK to the host PC using the supplied a USB cable. Windows should recognize the new device as *USB-MODEVM*. However, on some systems, it will be recognized as a USB Human Interface Device rather than an NI-VISA USB device.

To check this configuration, go to *Start*→*Control Panel*→*System*→*Hardware*→*Device Manager*. Look in the list and verify whether any NI-VISA USB Devices are shown. If so, the USB-MODEVM should be included in the list of the NI-VISA USB devices, and you can proceed to Step 10.

If the USB-MODEVM appears instead under *Human Interface Devices*, right-click on the device and select *Update Driver...* In the driver update screen, choose the option to select the driver from a list. When the list is given, you should have the choice of either a Human Interface Device or the USB-MODEVM. Select the *USB-MODEVM* and install the new driver.

If the USB-MODEVM does not appear as an option, go to the **C:\Windows\inf** directory and see if the *USB-MODEVM\_WDM.inf* file exists. If this file is present, right-click on the file and select *Install...* Repeat the *Update Driver...* process described in the previous paragraph.

If the *USB-MODEVM\_WDM.inf* file does not exist in the **C:\Windows\inf** directory, go to the CD-ROM and locate the **inf\_file.zip** archive. This archive contains the *USB-MODEVM\_WDM.inf* file. Copy the archive to your hard disk, unzip the archive, and move the *USB-MODEVM\_WDM.inf* file to the **C:\Windows\inf** directory. Once the file is moved, right-click on the file and select *Install...* Repeat the *Update Driver...* process described previously in this section.

**Step 9:** Disconnect the USB\_MODEVM hardware and reconnect to the USB cable. Repeat Step 8 to check that it is now recognized as an NI-VISA USB Device. When the hardware is recognized and listed as a NI-VISA USB device, proceed to Step 10.

**Step 10:** Installation is complete. You may now proceed with using the PDK software.

### 3.4 Operating the Applications Software

To start the applications software, click on the *Start* menu icon and navigate to *Programs*→*Texas Instruments*→*USB-SerialCommander*. Click on the *USB-SerialCommander* to start the application. The window shown in [Figure 4](#) appears. The Command Buffer text area will be empty when the application initially launches.

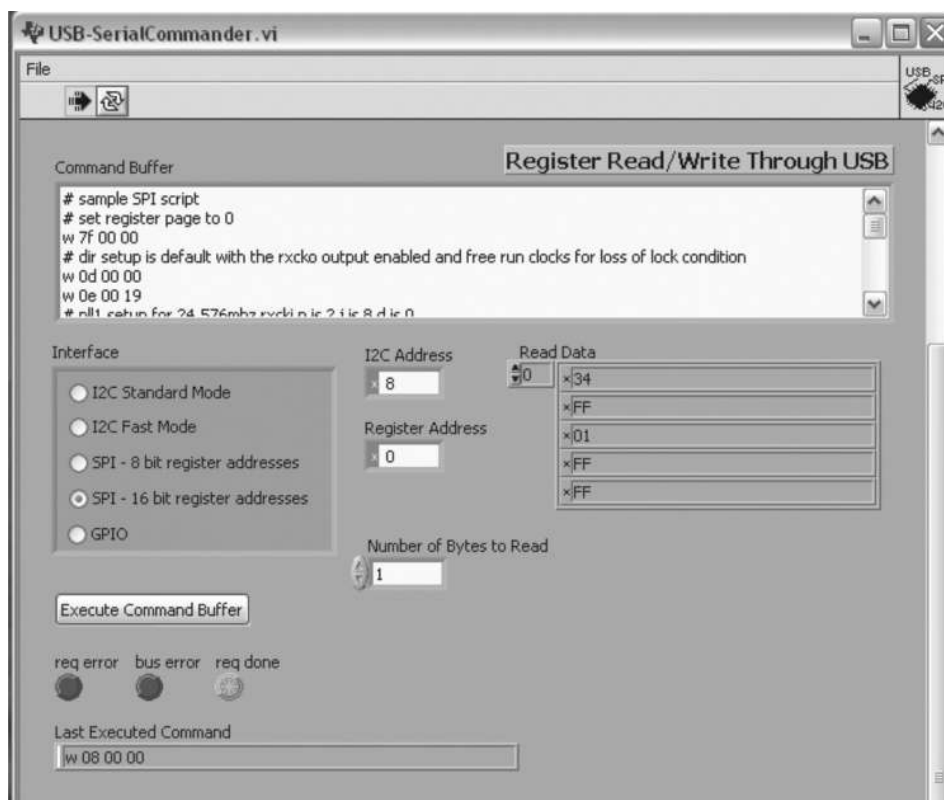

**Figure 4. Applications Software Window (USB Serial Commander)**

The first order of business is to select the Interface, using one of the five radio buttons shown in the Interface panel. For an I<sup>2</sup>C host interface configurations, either the *I<sup>2</sup>C Standard Mode* or *I<sup>2</sup>C Fast Mode* may be selected. For an SPI host interface configuration, the *SPI-16 bit register addresses* mode must be selected.

On the CD-ROM accompanying the PDK, there is a folder named *Sample Command Files*. These files have been written to exercise specific portions and functions of the DIX4192. The sample files also provide the user with code that can be copied and modified as needed, assisting the learning process. Any standard text editor, such as Notepad, can be utilized to edit and create command files.

Click on the applications **File** menu. There is only one selection under the File menu: *Open Command File...* Clicking on this menu selection displays an open file dialog, where sample command files may be located and loaded.

Once a command file has been loaded, the Command Buffer text area displays the script code. You may scroll through this code, as well as select and edit code as needed. The user can also select and delete the contents of the Command Buffer and manually enter his or her own script code. [Section 3.5](#) and [Section 3.6](#) of this guide provide command syntax information for writing scripts. When you are ready to execute the script code in the Command Buffer, simply click on the *Execute Command Buffer* button.

#### 3.4.1 Error Indicators

There are three indicators below the *Execute Command Buffer* button. When a command buffer is successfully executed, the **req done** indicator glows green. If a command request or an SPI/I<sup>2</sup>C bus error occurs, then the **req error** or **bus error** indicators glow red. Typical errors include selecting the wrong interface mode for the given command buffer contents, running command syntax that is invalid, and bus configuration or electrical errors.

#### 3.4.2 Last Executed Command Field

This field is located below the error indicators, and contains the text of the last executed command (not including Break commands).

#### 3.4.3 Read Data Display

The Read Data display shows a list of hexadecimal values, with the first four values being program status information, followed by the data bytes read from control or status registers using a Read command. [Figure 5](#) illustrates the results of an SPI read command. The Last Executed Command field shows that a read command was executed. This information is reiterated in the text field to the left of the Read Data display. Ignoring the first four bytes of the Read Data display, the last four bytes correspond to the data located in the four register addresses referenced by the Read command.

### 3.4.4 Command Script Paused Dialog

This dialog is presented when a Break command is executed in the Command Buffer, and is shown in [Figure 5](#). The Break command pauses the Command Buffer execution until the **OK** button is clicked. Read commands must always be followed by a Break command, so that the user may evaluate the Read Data display results.

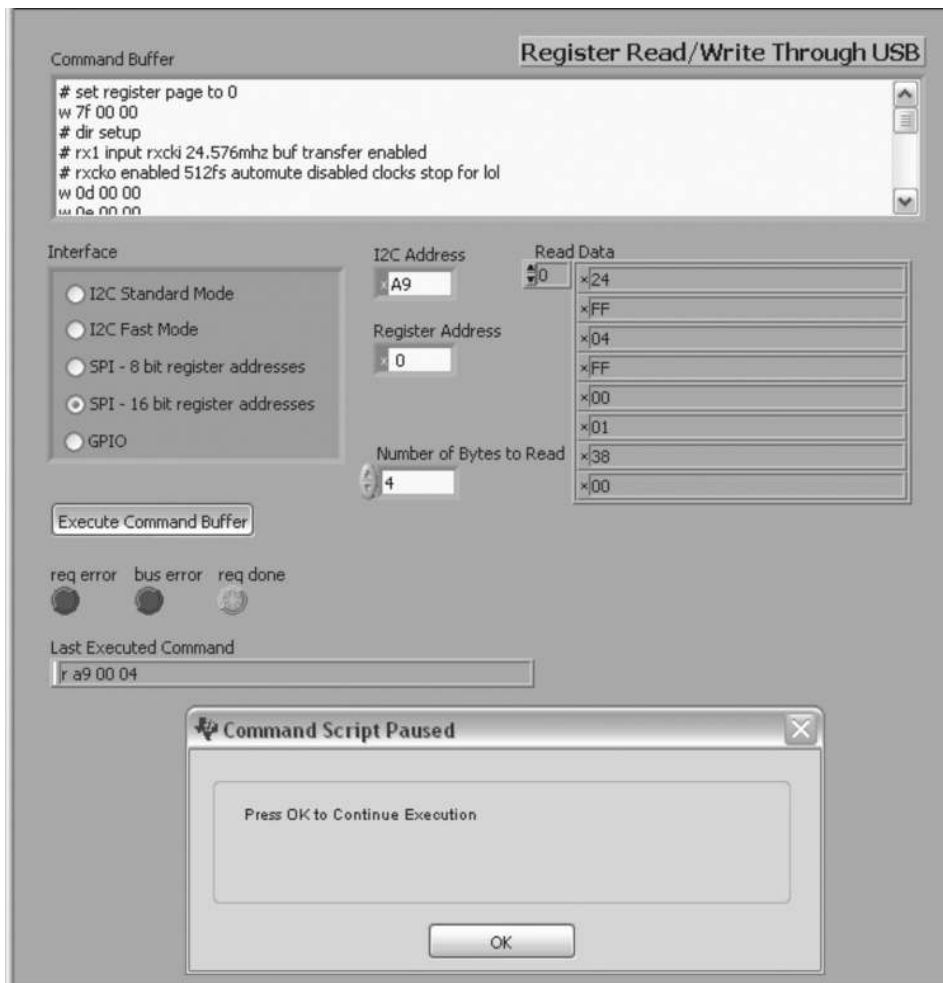

Figure 5. Example of a Readback Display and Break Message in the USB Serial Commander Application

### 3.5 Command Syntax for SPI Communications

Simple but strict command syntax is required for the command files utilized by the applications software. The command syntax for SPI communications are summarized in [Table 12](#). Each command must be terminated with a carriage return, and must fit on a single line.

Table 12. SPI Command Syntax

| Command        | Syntax                     |
|----------------|----------------------------|
| Write          | w rr 00 dd                 |
| Read           | r rr 00 bb                 |
| Break          | b                          |
| Comment        | # write your comments here |
| Interface Mode | i spi16                    |

Where:

- rr = The register address (Hex)
- dd = The register data (Hex)
- bb = The number of bytes to be read (Hex)

For the DIX4192, the SPI 16-bit address mode must always be utilized, as the second byte (00) is interpreted as the second byte of the address by the USB Serial Commander. The first line of the command file should always be the interface mode syntax shown in [Table 12](#).

When setting the register address for an SPI command, the most significant bit of the address is the Read/Write bit. Set this bit to '0' for Write operations, and to '1' for Read operations.

**Example 1.**

```
# write register 01 to power-up all function blocks
w 01 00 3f
```

**Example 2.**

```
# read the Q sub code data registers and then break for read data display results
r 9f 00 0a
b
```

**3.6 Command Syntax for I<sup>2</sup>C Communications**

The command syntax for I<sup>2</sup>C communications are summarized in [Table 13](#). Each command must be terminated with a carriage return, and must fit on a single line.

**Table 13. I<sup>2</sup>C Command Syntax**

| Command                                | Syntax                     |
|--|----------------------------|
| Write                                  | w ss rr dd                 |
| Read                                   | r ss rr bb                 |
| Break                                  | b                          |
| Comment                                | # write your comments here |
| Interface Mode (I <sup>2</sup> C Slow) | i i2cslow                  |
| Interface Mode (I <sup>2</sup> C Fast) | i i2cfast                  |

Where:

- ss = The I<sup>2</sup>C slave address for the DIX4192 (Hex).
- rr = The register address byte (Hex)
- dd = The register data (Hex)
- bb = The number of bytes to be read (Hex)

For the DIX4192, the I<sup>2</sup>C interface mode may be Slow or Fast. The first line of the command file should always indicate the speed of the interface, and match the selection shown in the Interface section of the USB Serial Commander window. Generally, the interface may be set to Fast mode for all operations.

When setting the slave address, the R/W bit does not need to be included, because the Write or Read command will set this bit automatically.

The most significant bit of the Register Address Byte is the INC, or auto-increment bit. When set to '0', auto-increment mode is disabled. When set to '1', auto-increment mode is enabled. Refer to the datasheet for additional information regarding auto-increment mode for I<sup>2</sup>C write and read operations.

**Example 3.**

```
# write register 01 to power up all function blocks  
w e0 01 3f
```

**Example 4.**

```
# read the non pcm status register and then break for read data display results  
r e0 12 01  
b
```

**Example 5.**

```
# read the Q sub code data registers and then break for read data display results  
# reading multiple registers requires that the auto increment bit be set to 1  
r e0 9f 0a  
b
```

## 4 Hardware Reference

This section includes schematics for the EVM and DAIMB boards, as well as a Bill of Materials for each board.

### 4.1 Schematics

The schematics for the EVM and DAIMB boards are shown in [Figure 6](#) through [Figure 8](#).

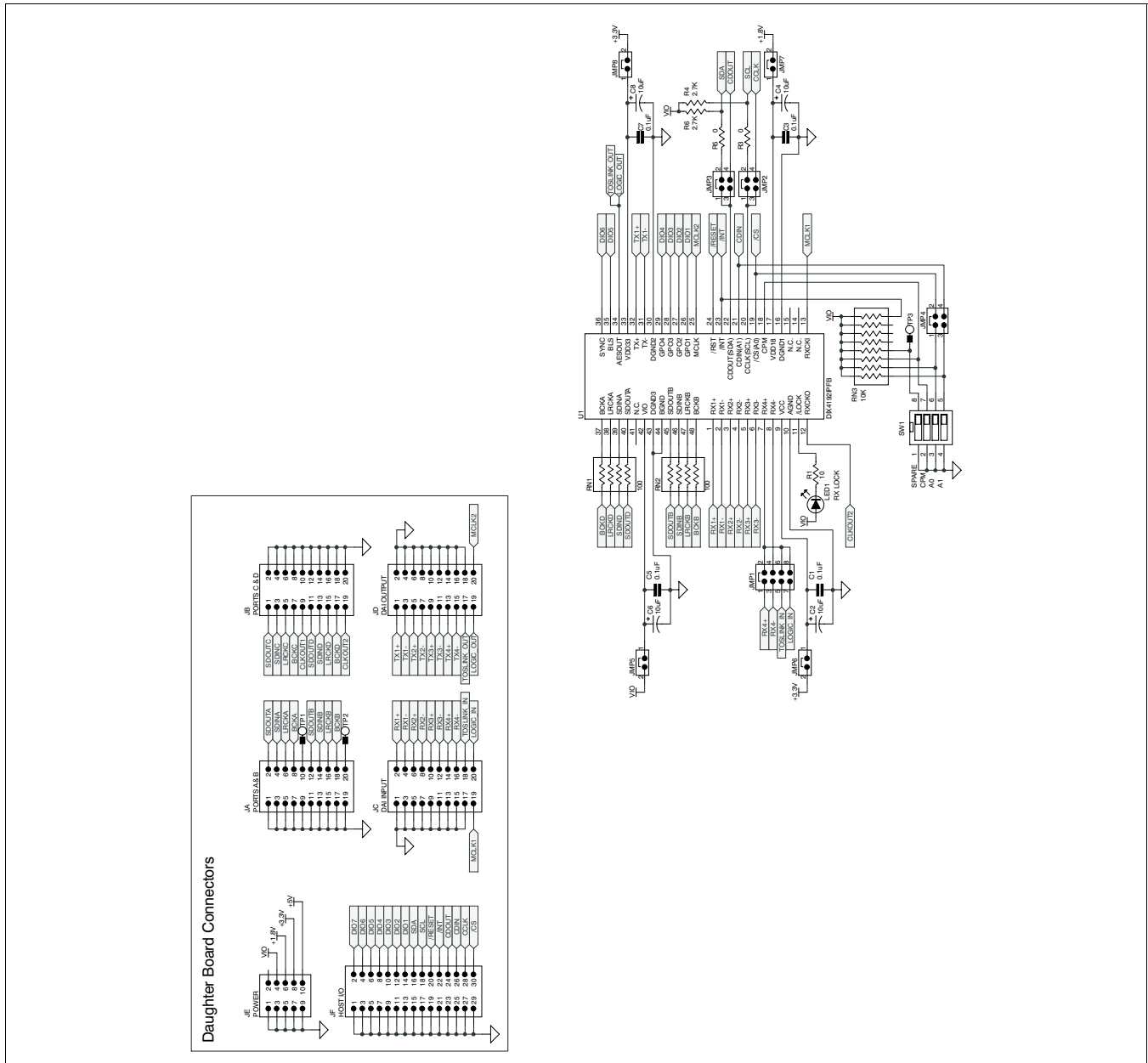

Figure 6. Electrical Schematic: DIX4192EVM Daughterboard

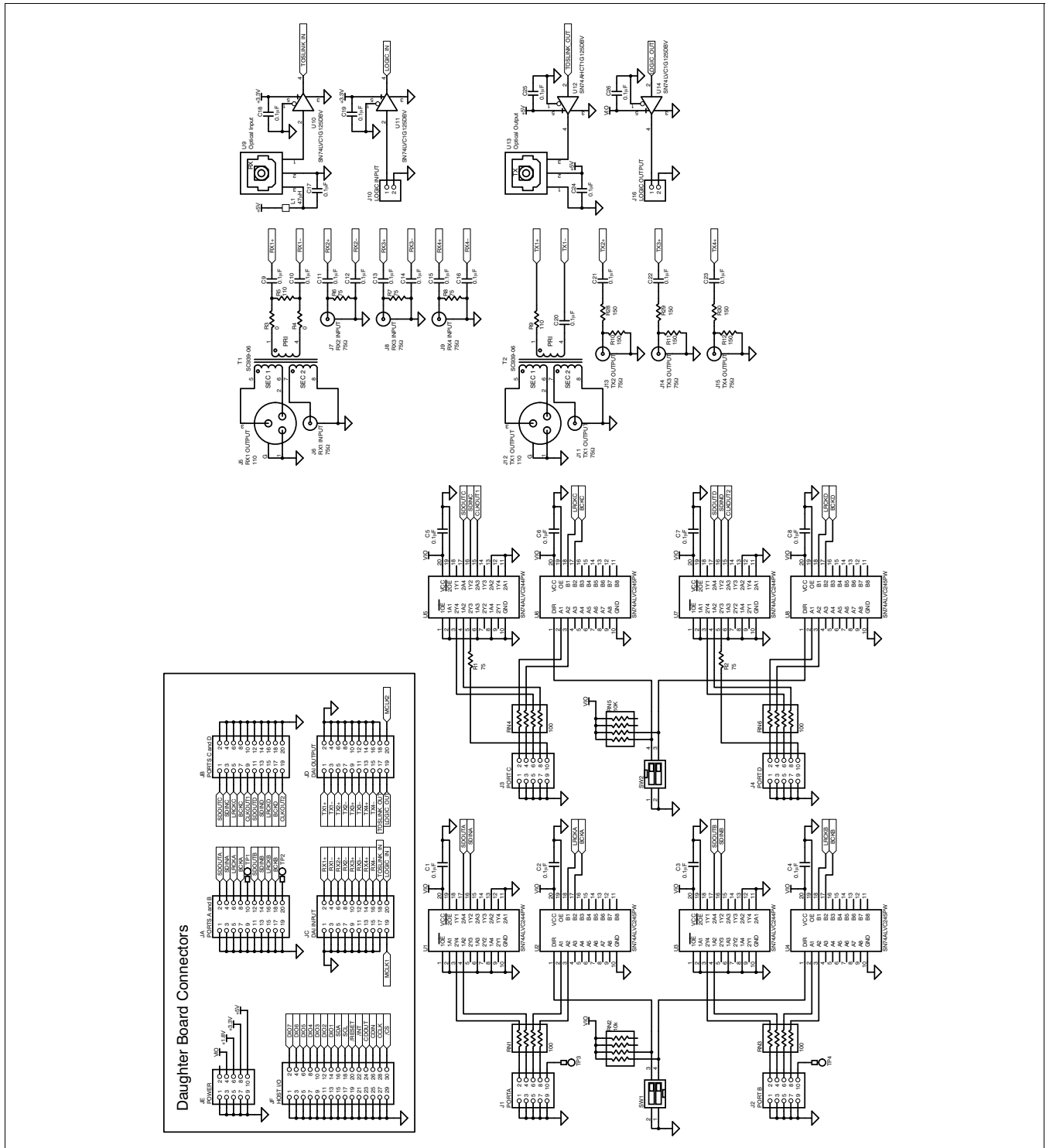

Figure 7. Electrical Schematic: DAIMB Motherboard, Page 1



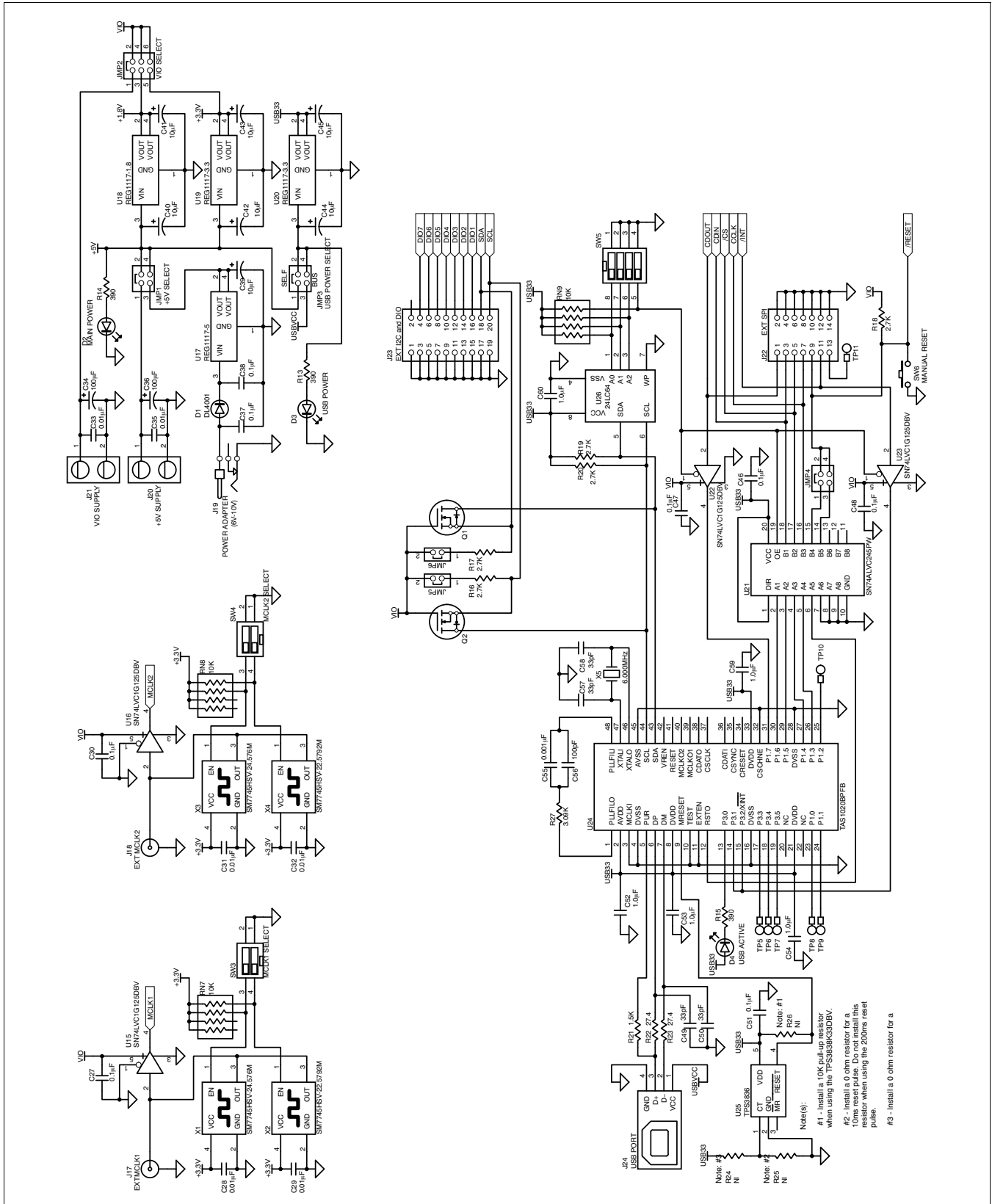

Figure 8. Electrical Schematic: DAIMB Motherboard, Page 2

## 4.2 Bills of Material

**Table 14. Bill of Materials for the DIX4192EVM**

| ITEM | VALUE | REFERENCE DESIGNATOR | QTY PER BOARD | MFR                | MFR PART NUMBER | DESCRIPTION   |
|------|-------|----------------------|---------------|--------------------|-----------------|---|
| 1    | 0     | R3, R5               | 2             | Panasonic          | ERJ-3GEY0R00V   | Resistor, 0Ω, Size = 0603   |
| 2    | 10    | R1                   | 1             | Panasonic          | ERJ-3GEYJ100V   | Resistor, Thick Film Chip 10Ω, 5%, 1/10W, Size = 0603                   |
| 3    | 2.7K  | R4, R6               | 2             | Panasonic          | ERJ-3GEYJ272V   | Resistor, Thick Film Chip, 2.7kΩ, 5%, 1/10W Size = 0603                 |
| 4    | 100   | RN1, RN2             | 2             | CTS                | 742C083101J     | Thick Film Chip Resistor Array 100Ω, 8-Terminal, 4 Resistors, Isolated  |
| 5    | 10k   | RN3                  | 1             | CTS                | 742C163103J     | Thick Film Chip Resistor Array 10kΩ, 16-Terminal, 8 Resistors, Isolated |
| 6    | 0.1μF | C1, C3, C5, C7       | 4             | TDK                | C1608X7R1E104K  | Chip Capacitor, X7R Ceramic 0.1μF ±10%, 25V, Size = 0603                |
| 7    | 10μF  | C2, C4, C6, C8       | 4             | Kemet              | T491A106K010AS  | Chip Capacitor, Tantalum, 10μF ±10%, 10V, Size = A                      |
| 8    |       | U1                   | 1             | Texas Instruments  | DIX4192IPFB     | Integrated Digital Audio Interface Receiver and Transmitter (DIR & DIT) |
| 9    |       | LED1                 | 1             | Lumex              | SML-LX0603GW-TR | Green LED, SMT, Size = 0603   |
| 10   |       | JA, JB, JC, JD       | 4             | Samtec             | SSW-110-02-G-D  | Socket Strip, Dual Row, 10x2  |
| 11   |       | JE                   | 1             | Samtec             | SSW-105-02-G-D  | Socket Strip, Dual Row, 5x2   |
| 12   |       | JF                   | 1             | Samtec             | SSW-115-02-G-D  | Socket Strip, Dual Row, 15x2  |
| 13   |       | JMP1                 | 1             | Samtec             | TSW-104-07-G-D  | Terminal Strip, Dual Row, 4x2   |
| 14   |       | JMP2-JMP4            | 3             | Samtec             | TSW-102-07-G-D  | Terminal Strip, Dual Row, 2x2   |
| 15   |       | JMP5-JMP8            | 4             | —                  | —               | Bus Wire, 18 to 22 guage  |
| 16   |       | SW1                  | 1             | ITT Industries/C&K | TDA04H0SK1      | DIP Switch, 4-element, Half-pitch Surface-Mount, Tape Sealed            |
| 17   |       |                      | 6             | Samtec             | SNT-100-BK-G-H  | Shorting Blocks   |
| 18   |       | PWB                  | 1             | Texas Instruments  | 6479511         | DIX4192EVM Printed Circuit Board  |

**Table 15. Bill of Materials for the DAIMB**

| ITEM | VALUE         | REFERENCE DESIGNATOR           | QTY PER BOARD | MFR                   | MFR PART NUMBER   | DESCRIPTION  |
|------|---------------|--------------------------------|---------------|-----------------------|-------------------|--|
| 1    | 0             | R3, R4, R24                    | 3             | Panasonic             | ERJ-3GEY0R00V     | Resistor, 0Ω, Size = 0603  |
| 2    | Not Installed | R25                            | 1             | Panasonic             | ERJ-3GEY0R00V     | Resistor, 0Ω, Size = 0603  |
| 3    | 27.4          | R22, R23                       | 2             | Panasonic             | ERJ-3EKF27R4V     | Resistor, Thick Film Chip 27.4Ω, 1%, 1/16W, Size = 0603                |
| 4    | 75            | R1, R2, R6–R8                  | 5             | Panasonic             | ERJ-3EKF75R0V     | Resistor, Thick Film Chip 75Ω, 1%, 1/16W, Size = 0603                  |
| 5    | 110           | R5, R9                         | 2             | Panasonic             | ERJ-3EKF1100V     | Resistor, Thick Film Chip 110Ω, 1%, 1/16W, Size = 0603                 |
| 6    | 150           | R10–R12, R28–R30               | 6             | Panasonic             | ERJ-3EKF1500V     | Resistor, Thick Film Chip 150Ω, 1%, 1/16W, Size = 0603                 |
| 7    | 392           | R13–R15                        | 3             | Panasonic             | ERJ-3EKF3920V     | Resistor, Thick Film Chip 392Ω, 1%, 1/16W, Size = 0603                 |
| 8    | 1.5K          | R21                            | 1             | Panasonic             | ERJ-3EKF1501V     | Resistor, Thick Film Chip 1.5kΩ, 1%, 1/16W, Size = 0603                |
| 9    | 2.7K          | R16–R20                        | 5             | Panasonic             | ERJ-3GEYJ272V     | Resistor, Thick Film Chip 2.7kΩ, 5%, 1/10W Size = 0603                 |
| 10   | 3.09K         | R27                            | 1             | Panasonic             | ERJ-3EKF3091V     | Resistor, Thick Film Chip 3.09kΩ, 1%, 1/16W, Size = 0603               |
| 11   | Not Installed | R26                            | 1             | Panasonic             | ERJ-3EKF1002V     | Resistor, Thick Film Chip 10kΩ, 1%, 1/16W, Size = 0603                 |
| 12   | 100           | RN1, RN3, RN4, RN6             | 4             | CTS                   | 742C083101J       | Thick Film Chip Resistor Array 100Ω, 8-Terminal, 4 Resistors, Isolated |
| 13   | 10k           | RN2, RN5, RN7–RN9              | 5             | CTS                   | 742C083103J       | Thick Film Chip Resistor Array 10kΩ, 8-Terminal, 4 Resistors, Isolated |
| 14   | 33pF          | C49, C50, C57, C58             | 4             | TDK                   | C1608C0G1H330J    | Chip Capacitor, C0G Ceramic 33pF ±5%, 50V, Size = 0603                 |
| 15   | 100pF         | C56                            | 1             | TDK                   | C1608C0G1H101J    | Chip Capacitor, C0G Ceramic 100pF ±5%, 50V, Size = 0603                |
| 16   | 0.001μF       | C55                            | 1             | TDK                   | C1608C0G1H102J    | Chip Capacitor, C0G Ceramic 0.001μF ±5%, 50V, Size = 0603              |
| 17   | 0.01μF        | C28, C29, C31–C33, C35         | 6             | TDK                   | C1608X7R1H103K    | Chip Capacitor, X7R Ceramic 0.01μF ±10%, 50V, Size = 0603              |
| 18   | 0.1μF         | C1–C27, C30, C37, C46–C48, C51 | 33            | TDK                   | C1608X7R1E104K    | Chip Capacitor, X7R Ceramic 0.1μF ±10%, 25V, Size = 0603               |
| 19   | 1μF           | C38, C52–C54, C59, C60         | 6             | TDK                   | C1608X7R1C105K    | Chip Capacitor, X7R Ceramic 1μF ±10%, 16V, Size = 0603                 |
| 20   | 10μF          | C39–C45                        | 7             | Kemet                 | T491A106K010AS    | Chip Capacitor, Tantalum, 10μF ±10%, 10V, Size = A                     |
| 21   | 100μF         | C34, C36                       | 2             | Panasonic             | EEV-FK1C101P      | Capacitor, Alum Elect, SMT, 100μF ±20%, 16V, Size = D                  |
| 22   | 47μH          | L1                             | 1             | Panasonic             | ELJ-FA470KF       | Inductor, SMT, 47μH ±10%, Size = 1210                                  |
| 23   |               | T1, T2                         | 2             | Scientific Conversion | SC939-06          | Dual Zo Digital Audio Transformer                                      |
| 24   |               | U1, U3, U5, U7                 | 4             | Texas Instruments     | SN74ALVC244PWR    | Octal Buffer/Driver with Tri-State Outputs                             |
| 25   |               | U2, U4, U6, U8, U21            | 5             | Texas Instruments     | SN74ALVC245PWR    | Octal Bus Transceiver with Tri-State Outputs                           |
| 26   |               | U9                             | 1             | Toshiba               | TORX179P          | TOSLINK™ Optical Receiver  |
|      |               |                                |               |                       | <b>or</b>         |  |
|      |               |                                |               |                       | TORX179PL         | TOSLINK Optical Receiver   |
| 27   |               | U10, U11, U14–U16, U22, U23    | 7             | Texas Instruments     | SN74LVC1G125DBVR  | Single Buffer with Tri-State Output                                    |
| 28   |               | U12                            | 1             | Texas Instruments     | SN74AHCT1G125DBVR | Single Buffer with Tri-State Output and TTL Compatible Input           |
| 29   |               | U13                            | 1             | Toshiba               | TOTX179P          | TOSLINK Optical Transmitter  |
|      |               |                                |               |                       | <b>or</b>         |  |
|      |               |                                |               |                       | TOTX179PL         | TOSLINK Optical Transmitter  |

**Table 15. Bill of Materials for the DAIMB (continued)**

| ITEM | VALUE         | REFERENCE DESIGNATOR | QTY PER BOARD | MFR                         | MFR PART NUMBER      | DESCRIPTION  |
|------|---------------|----------------------|---------------|-----------------------------|----------------------|--|
| 30   |               | U17                  | 1             | Texas Instruments           | REG1117-5            | Linear Voltage Regulator with +5V Fixed Output   |
| 31   |               | U18                  | 1             | Texas Instruments           | REG1117A-1.8         | Linear Voltage Regulator with +1.8V Fixed Output   |
| 32   |               | U19, U20             | 2             | Texas Instruments           | REG1117-3.3          | Linear Voltage Regulator with +3.3V Fixed Output   |
| 33   |               | U24                  | 1             | Texas Instruments           | TAS1020BPFB          | USB Streaming Controller   |
| 34   |               | U25                  | 1             | Texas Instruments           | TPS3836K33DBVR       | Nanopower Supervisory Circuit with Active Low Push-Pull Output                                 |
|      |               |                      |               | <b>or</b>                   |                      |  |
|      |               |                      |               | Texas Instruments           | TPS3838K33DBVR       | Nanopower Supervisory Circuit with Active Low Open Drain Output (requires installation of R26) |
| 35   |               | U26                  |               | Microchip                   | 24LC64I/SN           | 64k EEPROM with 2-wire I <sup>2</sup> C Serial Interface                                       |
| 36   |               | D1                   |               | Micro Commercial Components | DL4001               | Diode, 50V, 1A, MELF SMT   |
| 37   |               | D2, D3               | 2             | Lumex                       | SML-LX0603GW-TR      | Green LED, SMT, Size = 0603  |
| 38   |               | D4                   | 1             | Lumex                       | SML-LX0603YW-TR      | Yellow LED, SMT, Size = 0603   |
| 39   |               | Q1, Q2               | 2             | Zetex                       | ZXMN6A07F            | N-channel MOSFET, SMT  |
| 40   |               | X1, X3               | 2             | Pletronics                  | SM7745HSV-24.576M    | +3.3V SMT Clock Oscillator with CMOS Output and Active High Enable 24.576MHz ±50ppm            |
| 41   |               | X2, X4               | 2             | Pletronics                  | SM7745HSV-22.5792M   | +3.3V SMT Clock Oscillator with CMOS Output and Active High Enable 22.5792MHz ±50ppm           |
| 42   |               | X5                   | 1             | Citizen                     | HCM49-6.000MABJT     | 6.000MHz Crystal, SMT  |
|      |               |                      |               | <b>or</b>                   |                      |  |
|      |               |                      |               | Epson                       | MA-505 6.000M-C0     | 6.000MHz Crystal, SMT  |
|      |               |                      |               | <b>or</b>                   |                      |  |
|      |               |                      |               | CTS                         | ATS060SM-T           | 6.000MHz Crystal, SMT  |
| 43   |               | J1–J4, JE            | 5             | Samtec                      | TSW-105-07-G-D       | Terminal Strip, Dual Row, 5x2  |
| 44   |               | J5                   | 1             | Neutrik                     | NC3FAH2              | 3-pin Female XLR Chassis Connector, Horizontal PC Mount with Latch                             |
| 45   |               | J6–J9, J11, J13–J15  | 8             | CUI Stack                   | RCJ-041              | RCA Jack, PC Mount, Black  |
| 46   |               | J10, J16, JMP5, JMP6 | 4             | Samtec                      | TSW-102-07-G-S       | Terminal Strip, 2x1  |
| 47   |               | J12                  | 1             | Neutrik                     | NC3MAH-0             | 3-pin Male XLR Chassis Connector, Horizontal PC Mount  |
| 48   |               | J17, J18             | 2             | Tyco AMP                    | 414305-1             | BNC Connector, Female, PC Mount  |
| 49   |               | J19                  | 1             | CUI Stack                   | PJ-102BH             | 2.5mm Male Power Jack, PCB Mount, Silver Plated  |
| 50   |               | J20, J21             | 2             | Weidmuller                  | 1699670000           | Terminal Block, 2 poles, 3.5mm PCB   |
| 51   |               | J22                  | 1             | Samtec                      | TSW-107-07-G-D       | Terminal Strip, Dual Row, 7x2  |
| 52   |               | J23, JA, JB, JC, JD  | 5             | Samtec                      | TSW-110-07-G-D       | Terminal Strip, Dual Row, 10x2   |
| 53   |               | J24                  | 1             | Mill-Max                    | 897-30-004-90-000000 | USB Type B Receptacle, Single, Through-Hole  |
| 54   |               | JF                   | 1             | Samtec                      | TSW-115-07-G-D       | Terminal Strip, Dual Row, 15x2   |
| 55   |               | JMP1, JMP3           | 2             | Samtec                      | TSW-102-07-G-D       | Terminal Strip, Dual Row, 2x2  |
| 56   | Not Installed | JMP4                 | 1             | Samtec                      | TSW-102-07-G-D       | Terminal Strip, Dual Row, 2x2  |
| 57   |               | JMP2                 | 1             | Samtec                      | TSW-103-07-G-D       | Terminal Strip, Dual Row, 3x2  |
| 58   |               | SW1-SW4              | 4             | ITT Industries/C&K          | TDA02H0SK1           | DIP Switch, 2-element, Half-pitch Surface-Mount, Tape Sealed                                   |

**Table 15. Bill of Materials for the DAIMB (continued)**

| ITEM | VALUE | REFERENCE DESIGNATOR | QTY PER BOARD | MFR                | MFR PART NUMBER | DESCRIPTION  |
|------|-------|----------------------|---------------|--------------------|-----------------|--|
| 59   |       | SW5                  | 1             | ITT Industries/C&K | TDA04H0SK1      | DIP Switch, 4-element, Half-pitch Surface-Mount, Tape Sealed |
| 60   |       | SW6                  | 1             | Omron              | B3S-1000        | Momentary Tact Switch, SMT, Without Ground Terminal          |
| 61   |       |                      | 5             | Samtec             | SNT-100-BK-G-H  | Shorting Blocks  |
| 62   |       |                      | 5             | 3M Bumpon          | SJ-5003         | Rubber Feet, Adhesive Backed                                 |
| 63   |       | PWB                  | 1             | Texas Instruments  | 6472591         | DAIMB Printed Circuit Board                                  |

## FCC Warning

This evaluation board/kit is intended for use for **ENGINEERING DEVELOPMENT, DEMONSTRATION, OR EVALUATION PURPOSES ONLY** and is not considered by TI to be a finished end-product fit for general consumer use. It generates, uses, and can radiate radio frequency energy and has not been tested for compliance with the limits of computing devices pursuant to part 15 of FCC rules, which are designed to provide reasonable protection against radio frequency interference. Operation of this equipment in other environments may cause interference with radio communications, in which case the user at his own expense will be required to take whatever measures may be required to correct this interference.

### EVALUATION BOARD/KIT IMPORTANT NOTICE

Texas Instruments (TI) provides the enclosed product(s) under the following conditions:

This evaluation board/kit is intended for use for **ENGINEERING DEVELOPMENT, DEMONSTRATION, OR EVALUATION PURPOSES ONLY** and is not considered by TI to be a finished end-product fit for general consumer use. Persons handling the product(s) must have electronics training and observe good engineering practice standards. As such, the goods being provided are not intended to be complete in terms of required design-, marketing-, and/or manufacturing-related protective considerations, including product safety and environmental measures typically found in end products that incorporate such semiconductor components or circuit boards. This evaluation board/kit does not fall within the scope of the European Union directives regarding electromagnetic compatibility, restricted substances (RoHS), recycling (WEEE), FCC, CE or UL, and therefore may not meet the technical requirements of these directives or other related directives.

Should this evaluation board/kit not meet the specifications indicated in the User's Guide, the board/kit may be returned within 30 days from the date of delivery for a full refund. **THE FOREGOING WARRANTY IS THE EXCLUSIVE WARRANTY MADE BY SELLER TO BUYER AND IS IN LIEU OF ALL OTHER WARRANTIES, EXPRESSED, IMPLIED, OR STATUTORY, INCLUDING ANY WARRANTY OF MERCHANTABILITY OR FITNESS FOR ANY PARTICULAR PURPOSE.**

The user assumes all responsibility and liability for proper and safe handling of the goods. Further, the user indemnifies TI from all claims arising from the handling or use of the goods. Due to the open construction of the product, it is the user's responsibility to take any and all appropriate precautions with regard to electrostatic discharge.

**EXCEPT TO THE EXTENT OF THE INDEMNITY SET FORTH ABOVE, NEITHER PARTY SHALL BE LIABLE TO THE OTHER FOR ANY INDIRECT, SPECIAL, INCIDENTAL, OR CONSEQUENTIAL DAMAGES.**

TI currently deals with a variety of customers for products, and therefore our arrangement with the user **is not exclusive.**

TI assumes **no liability for applications assistance, customer product design, software performance, or infringement of patents or services described herein.**

Please read the User's Guide and, specifically, the Warnings and Restrictions notice in the User's Guide prior to handling the product. This notice contains important safety information about temperatures and voltages. For additional information on TI's environmental and/or safety programs, please contact the TI application engineer or visit [www.ti.com/esh](http://www.ti.com/esh).

No license is granted under any patent right or other intellectual property right of TI covering or relating to any machine, process, or combination in which such TI products or services might be or are used.

### EVM WARNINGS AND RESTRICTIONS

It is important to operate this EVM within the input voltage range of the Absolute Operating Conditions and the output voltage range of the Absolute Operating Conditions (see [Table 1](#)).

Exceeding the specified input range may cause unexpected operation and/or irreversible damage to the EVM. If there are questions concerning the input range, please contact a TI field representative prior to connecting the input power.

Applying loads outside of the specified output range may result in unintended operation and/or possible permanent damage to the EVM. Please consult the EVM User's Guide prior to connecting any load to the EVM output. If there is uncertainty as to the load specification, please contact a TI field representative.

During normal operation, some circuit components may have case temperatures greater than 37°C. The EVM is designed to operate properly with certain components above 60°C as long as the input and output ranges are maintained. These components include but are not limited to linear regulators, switching transistors, pass transistors, and current sense resistors. These types of devices can be identified using the EVM schematic located in the EVM User's Guide. When placing measurement probes near these devices during operation, please be aware that these devices may be very warm to the touch.

Mailing Address: Texas Instruments, Post Office Box 655303, Dallas, Texas 75265  
Copyright © 2006, Texas Instruments Incorporated

## IMPORTANT NOTICE

Texas Instruments Incorporated and its subsidiaries (TI) reserve the right to make corrections, modifications, enhancements, improvements, and other changes to its products and services at any time and to discontinue any product or service without notice. Customers should obtain the latest relevant information before placing orders and should verify that such information is current and complete. All products are sold subject to TI's terms and conditions of sale supplied at the time of order acknowledgment.

TI warrants performance of its hardware products to the specifications applicable at the time of sale in accordance with TI's standard warranty. Testing and other quality control techniques are used to the extent TI deems necessary to support this warranty. Except where mandated by government requirements, testing of all parameters of each product is not necessarily performed.

TI assumes no liability for applications assistance or customer product design. Customers are responsible for their products and applications using TI components. To minimize the risks associated with customer products and applications, customers should provide adequate design and operating safeguards.

TI does not warrant or represent that any license, either express or implied, is granted under any TI patent right, copyright, mask work right, or other TI intellectual property right relating to any combination, machine, or process in which TI products or services are used. Information published by TI regarding third-party products or services does not constitute a license from TI to use such products or services or a warranty or endorsement thereof. Use of such information may require a license from a third party under the patents or other intellectual property of the third party, or a license from TI under the patents or other intellectual property of TI.

Reproduction of information in TI data books or data sheets is permissible only if reproduction is without alteration and is accompanied by all associated warranties, conditions, limitations, and notices. Reproduction of this information with alteration is an unfair and deceptive business practice. TI is not responsible or liable for such altered documentation.

Resale of TI products or services with statements different from or beyond the parameters stated by TI for that product or service voids all express and any implied warranties for the associated TI product or service and is an unfair and deceptive business practice. TI is not responsible or liable for any such statements.

TI products are not authorized for use in safety-critical applications (such as life support) where a failure of the TI product would reasonably be expected to cause severe personal injury or death, unless officers of the parties have executed an agreement specifically governing such use. Buyers represent that they have all necessary expertise in the safety and regulatory ramifications of their applications, and acknowledge and agree that they are solely responsible for all legal, regulatory and safety-related requirements concerning their products and any use of TI products in such safety-critical applications, notwithstanding any applications-related information or support that may be provided by TI. Further, Buyers must fully indemnify TI and its representatives against any damages arising out of the use of TI products in such safety-critical applications.

TI products are neither designed nor intended for use in military/aerospace applications or environments unless the TI products are specifically designated by TI as military-grade or "enhanced plastic." Only products designated by TI as military-grade meet military specifications. Buyers acknowledge and agree that any such use of TI products which TI has not designated as military-grade is solely at the Buyer's risk, and that they are solely responsible for compliance with all legal and regulatory requirements in connection with such use.

TI products are neither designed nor intended for use in automotive applications or environments unless the specific TI products are designated by TI as compliant with ISO/TS 16949 requirements. Buyers acknowledge and agree that, if they use any non-designated products in automotive applications, TI will not be responsible for any failure to meet such requirements.

Following are URLs where you can obtain information on other Texas Instruments products and application solutions:

| <b>Products</b>       |  | <b>Applications</b> |  |
|-----------------------|--|---------------------|--|
| Amplifiers            | <a href="http://amplifier.ti.com">amplifier.ti.com</a>             | Audio               | <a href="http://www.ti.com/audio">www.ti.com/audio</a>                   |
| Data Converters       | <a href="http://dataconverter.ti.com">dataconverter.ti.com</a>     | Automotive          | <a href="http://www.ti.com/automotive">www.ti.com/automotive</a>         |
| DSP                   | <a href="http://dsp.ti.com">dsp.ti.com</a>                         | Broadband           | <a href="http://www.ti.com/broadband">www.ti.com/broadband</a>           |
| Interface             | <a href="http://interface.ti.com">interface.ti.com</a>             | Digital Control     | <a href="http://www.ti.com/digitalcontrol">www.ti.com/digitalcontrol</a> |
| Logic                 | <a href="http://logic.ti.com">logic.ti.com</a>                     | Military            | <a href="http://www.ti.com/military">www.ti.com/military</a>             |
| Power Mgmt            | <a href="http://power.ti.com">power.ti.com</a>                     | Optical Networking  | <a href="http://www.ti.com/opticalnetwork">www.ti.com/opticalnetwork</a> |
| Microcontrollers      | <a href="http://microcontroller.ti.com">microcontroller.ti.com</a> | Security            | <a href="http://www.ti.com/security">www.ti.com/security</a>             |
| RFID                  | <a href="http://www.ti-rfid.com">www.ti-rfid.com</a>               | Telephony           | <a href="http://www.ti.com/telephony">www.ti.com/telephony</a>           |
| Low Power<br>Wireless | <a href="http://www.ti.com/lpw">www.ti.com/lpw</a>                 | Video & Imaging     | <a href="http://www.ti.com/video">www.ti.com/video</a>                   |
|                       |  | Wireless            | <a href="http://www.ti.com/wireless">www.ti.com/wireless</a>             |

Mailing Address: Texas Instruments, Post Office Box 655303, Dallas, Texas 75265  
Copyright © 2007, Texas Instruments Incorporated