

# PLD E 400 W ...

**LED enclosure light, 24 V DC,  
color temperature 5000 K, pivoting**

Data sheet  
106445\_en\_03

© PHOENIX CONTACT 2016-06-09



## 1 Description

The LED light is designed to illuminate the interior of control cabinets. The integrated prismatic design ensures optimum illumination of the control cabinet.

Accessories for clip fixing are supplied with the light. You can therefore mount the light without using tools.

For connected control cabinets, for example, multiple lights can be connected one after the other and therefore supplied using just one power supply unit.

The light mode can be controlled via a button. The light can be permanently switched on or off or automatic mode can be enabled. In automatic mode the light is switched on and off via a door position switch: the lighting is switched on when the control cabinet door is opened and off again when the control cabinet door is closed.

### Features

- Color temperature 5000 K
- Lights can be connected in series
- IP20 degree of protection
- Pivoting



Make sure you always use the latest documentation.  
It can be downloaded from the product at [phoenixcontact.net/products](http://phoenixcontact.net/products).

---

<b>2</b>	<b>Table of contents</b>	
1	Description .....	1
2	Table of contents .....	2
3	Ordering data .....	3
4	Technical data .....	4
5	Safety notes.....	7
6	Illuminance distribution .....	7
7	Pin assignment.....	9
8	Connection examples .....	10
9	Function description .....	10

### 3 Ordering data

Description	Type	Order No.	Pcs./Pkt.
LED enclosure light, 24 V DC, Degree of protection IP20, Color temperature 5000 K, Length 250 mm, pivoting, can be switched in series, including mounting accessories	PLD E 400 W 250	2702221	1
LED enclosure light, 24 V DC, Degree of protection IP20, Color temperature 5000 K, Length 375 mm, pivoting, can be switched in series, including mounting accessories	PLD E 400 W 375	2702222	1
LED enclosure light, 24 V DC, Degree of protection IP20, Color temperature 5000 K, Length 500 mm, pivoting, can be switched in series, including mounting accessories	PLD E 400 W 500	2702223	1
Accessories	Type	Order No.	Pcs./Pkt.
Primary-switched STEP POWER power supply for DIN rail mounting, input: 1-phase, output: 24 V DC/0.5 A	STEP-PS/ 1AC/24DC/0.5	2868596	1
Primary-switched STEP POWER power supply for DIN rail mounting, input: 1-phase, output: 24 V DC/0.75 A	STEP-PS/ 1AC/24DC/0.75/FL	2868622	1
Plug-in power supply unit for class 400 LED enclosure lights, including country-specific plug adapters for Europe, Great Britain, USA and Australia; max. output voltage 12 W	PLD E 400-PS/1AC/24DC/12W	2702435	1
Plug-in power supply unit for class 400 LED enclosure lights, including country-specific plug adapters for Europe, Great Britain, USA and Australia; max. output voltage 30 W	PLD E 400-PS/1AC/24DC/30W	2702436	1
Sensor/Actuator cable, 3-position, PUR halogen-free, black-gray RAL 7021, free cable end, on Socket straight M8 Snap-in, Cable length: 3 m, with ferrules	SAC-3P- 3,0-PUR/M 8SIFS AE	1417698	1
Sensor/Actuator cable, 3-position, PUR halogen-free, black-gray RAL 7021, Plug straight M8, on Socket straight M8 Snap-in, Cable length: 0.6 m	SAC-3P-M 8MS/ 0,6-PUR/M 8SIFS	1417699	1
Sensor/Actuator cable, 3-position, PUR halogen-free, black-gray RAL 7021, Plug straight M8, on Socket straight M8 Snap-in, Cable length: 1 m	SAC-3P-M 8MS/ 1,0-PUR/M 8SIFS	1417700	1
Sensor/Actuator cable, 3-position, PUR halogen-free, black-gray RAL 7021, Plug straight M8, on Socket straight M8 Snap-in, Cable length: 3 m	SAC-3P-M 8MS/ 3,0-PUR/M 8SIFS	1417701	1
Door position switch with 3 m cable with open cable end and 0.6 m cable with M8 socket (Snap-in), including mounting accessories	PLD E 400-DS-3,0/FS/0,6	2702336	1
Door position switch with 1 m cable with M8 plug and 0.6 m cable with M8 socket (Snap-in), including mounting accessories	PLD E 400-DS-MS/1,0-FS/0,6	2702337	1

Accessories	Type	Order No.	Pcs./Pkt.
Set for magnetic mounting of class 400 PLD enclosure lights	PLD E 400-ME MM	2702312	1
Set for screw mounting of class 400 PLD enclosure lights, including screws and washers	PLD E 400-ME SM	2702313	1
Set consisting of two clip retainers for class 400 PLD enclosure lights (replacement part)	PLD E 400-ME CM	2702314	1

## 4 Technical data

### Dimensions (nominal sizes in mm)

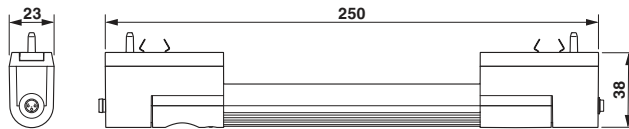

Length	250 mm
Width	23 mm
Height	38 mm

### Dimensions (nominal sizes in mm)

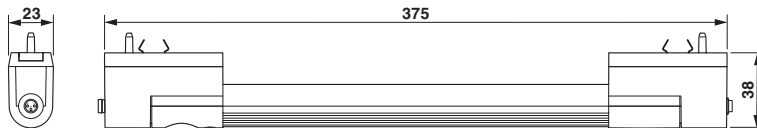

Length	375 mm
Width	23 mm
Height	38 mm

### Dimensions (nominal sizes in mm)

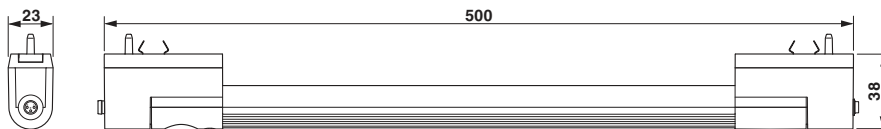

Length	500 mm
Width	23 mm
Height	38 mm

### General data

Weight (PLD E 400 W 250)	120 g
Weight (PLD E 400 W 375)	170 g
Weight (PLD E 400 W 500)	220 g
Color	traffic grey A RAL 7042
Ambient temperature (operation)	-25 °C ... 60 °C
Ambient temperature (storage/transport)	-40 °C ... 85 °C

**General data**

Permissible humidity (operation)	5 % ... 95 %
Permissible humidity (storage/transport)	5 % ... 95 %
Air pressure (operation)	70 kPa ... 106 kPa (up to 3000 m above sea level)
Air pressure (storage/transport)	70 kPa ... 106 kPa (up to 3000 m above sea level)
Degree of protection	IP20
Protection class	III
Mounting position	any
Mounting type	Clip mounting

**Special properties**

pivoting (Schwenkbereich  $\pm 90^\circ$ )  
 can be switched in series  
 including mounting accessories

**Connection data**

Connection method	M8 connector (snap-in)
Number of positions	3

**Power supply for module electronics**

Supply voltage	24 V DC
Supply voltage range	19.2 V DC ... 30 V DC
Power consumption (PLD E 400 W 250)	1.5 W
Power consumption (PLD E 400 W 375)	3 W
Power consumption (PLD E 400 W 500)	5 W



When using LED enclosure lights for the North American market, use class 2 power supply units.

**Light properties**

Source of light type	LED
Number of LEDs (PLD E 400 W 250)	5
Number of LEDs (PLD E 400 W 375)	12
Number of LEDs (PLD E 400 W 500)	20
Service life, lighting appliance	50,000 h (L70)
Light color	Neutral white
Color temperature	5000 K
Color rendering index	75
Luminous flux (PLD E 400 W 250)	140 lm (Net luminous flux)
Luminous flux (PLD E 400 W 375)	340 lm (Net luminous flux)
Luminous flux (PLD E 400 W 500)	560 lm (Net luminous flux)

**Light properties**

Illumination (PLD E 400 W 250)	max. 335 lx (50 cm distance) max. 85 lx (Distance of 1 m)
Illumination (PLD E 400 W 375)	max. 845 lx (50 cm distance) max. 210 lx (Distance of 1 m)
Illumination (PLD E 400 W 500)	max. 1350 lx (50 cm distance) max. 335 lx (Distance of 1 m)

**Mechanical tests**

Vibration resistance in acc. with EN 60068-2-6/ IEC 60068-2-6	5g
Shock in acc. with EN 60068-2-27/IEC 60068-2-27	25g
Continuous shock according to EN 60068-2-27/ IEC 60068-2-27	10g

**Conformance with EMC Directive 2014/30/EU****Noise immunity test in accordance with EN 61000-6-2**

Electrostatic discharge (ESD) EN 61000-4-2/IEC 61000-4-2	Criterion B; 4 kV contact discharge, 4 kV air discharge
Electromagnetic fields EN 61000-4-3/IEC 61000-4-3	Criterion A, Field intensity: 10 V/m
Fast transients (burst) EN 61000-4-4/IEC 61000-4-4	Criterion B; $\pm 2$ kV
Transient overvoltage (surge) EN 61000-4-5/IEC 61000-4-5	Criterion A, $\pm 1$ kV (symmetrical), $\pm 2$ kV (asymmetrical)
Conducted interference EN 61000-4-6/IEC 61000-4-6	Criterion A; Test voltage 10 V

**Noise emission test as per EN 61000-6-4**

Radio interference properties EN 55011	Class A
--	---------

**Approvals**

For the latest approvals, please visit [phoenixcontact.net/products](http://phoenixcontact.net/products).

## 5 Safety notes



**WARNING: Explosion hazard**

Do not install and operate the light in potentially explosive spaces!



**CAUTION: Impaired vision**

Looking at the light continually can temporarily impair vision. This can increase the danger of accidents. Therefore do not look at a light source for a long period.



**NOTE: Damage to the electronics**

The IP20 degree of protection (IEC 60529/EN 60529) of the device is intended for use in a clean and dry environment.

Do not subject the device to mechanical and/or thermal loads that exceed the specified limits.



**NOTE**

Before any work on the light, always switch off the supply voltage and ensure it cannot be switched on again!

## 6 Illuminance distribution

The illuminance distribution depends on the length of the light. Please refer to the figures below for the illuminance distribution.

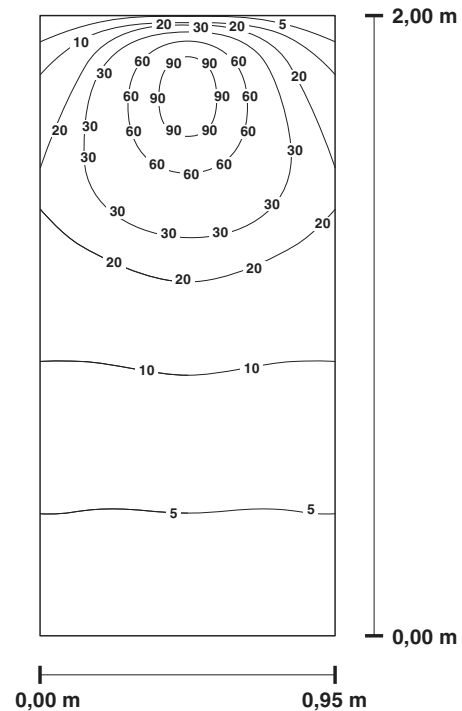

Figure 1 Lighting level distribution in Lux  
 PLD E 400 W 250 (installation depth of the control cabinet plate  $d = 200$  mm)

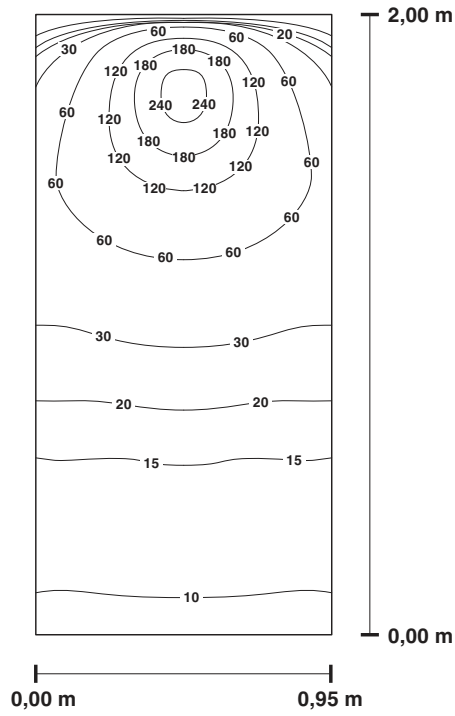

Figure 2 Lighting level distribution in Lux  
 PLD E 400 W 375 (installation depth of the  
 control cabinet plate d = 200 mm)

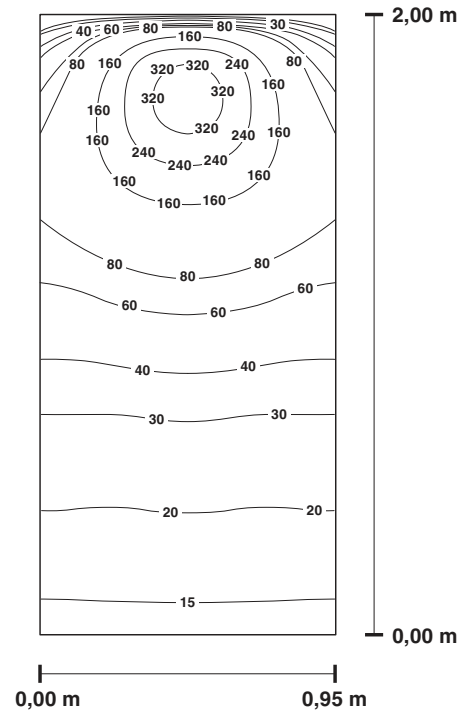

Figure 3 Lighting level distribution in Lux  
 PLD E 400 W 500 (installation depth of the  
 control cabinet plate d = 200 mm)



## 7 Pin assignment

To supply power to the light, connect the cable to the X01 IN connector.

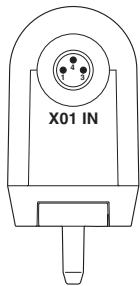

Figure 4 Connection of the supply voltage of a light

To connect multiple lights in series, connect the X02 OUT output of one light to the X01 IN input of the following light.

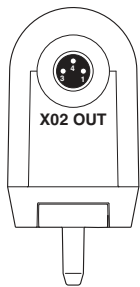

Figure 5 Forwarding of the supply voltage with the series connection of lights

### Pin assignment of the M8 connectors

Pin	Assignment	Conductor color	Note
1	+24 V DC	Brown	Power supply to the light
3	GND	Blue	
4	+24 V DC (switched)	Black	Signal from door position switch for controlling the light in mode A



Only use Phoenix Contact accessories!



**NOTE: device damage**

Make sure that the total current consumed by all the lights used in a series connection does not exceed 2 A.

## 8 Connection examples

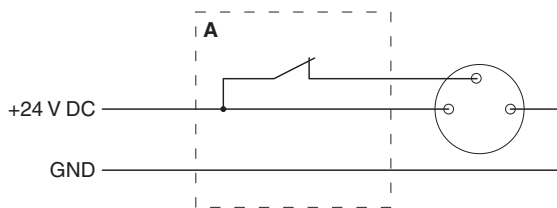

Figure 6 Connection of the light using a door position switch (A)



Figure 7 Connection of a light



Figure 8 Series connection of two lights

## 9 Function description

Once you have provided voltage to the light, it is ready for operation and in mode 0 (delivery condition) or in the most recently selected mode.

Button S1 on the light is used to control the light mode. The current mode is indicated via the status LED.

Press the button to change mode. Each time button S1 is pressed, the light changes to the next mode: 0 - A - I.

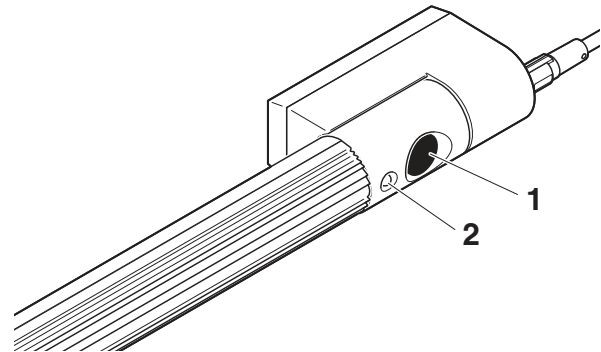

Figure 9 Button S1 and status LED

Mode	Status LED	Description
0	OFF	No supply voltage connected, or supply voltage connected but lamp switched off
A	Yellow ON	Light in standby mode, door position switch is active Lighting switches on when cabinet door is opened, switches back off when cabinet door is closed
I	Yellow flashing	Light is on continuously