

2-647123-6 ✓ ACTIVE

MTA 156

TE Internal #: 2-647123-6

Rectangular Power Connectors, Header, Plug, Wire-to-Board, 6 Position, 3.96 mm [.156 in] Centerline, Printed Circuit Board, UL 94V-0, MTA 156

[View on TE.com >](#)



Connectors > Power Connectors > Rectangular Power > Rectangular Power Connectors

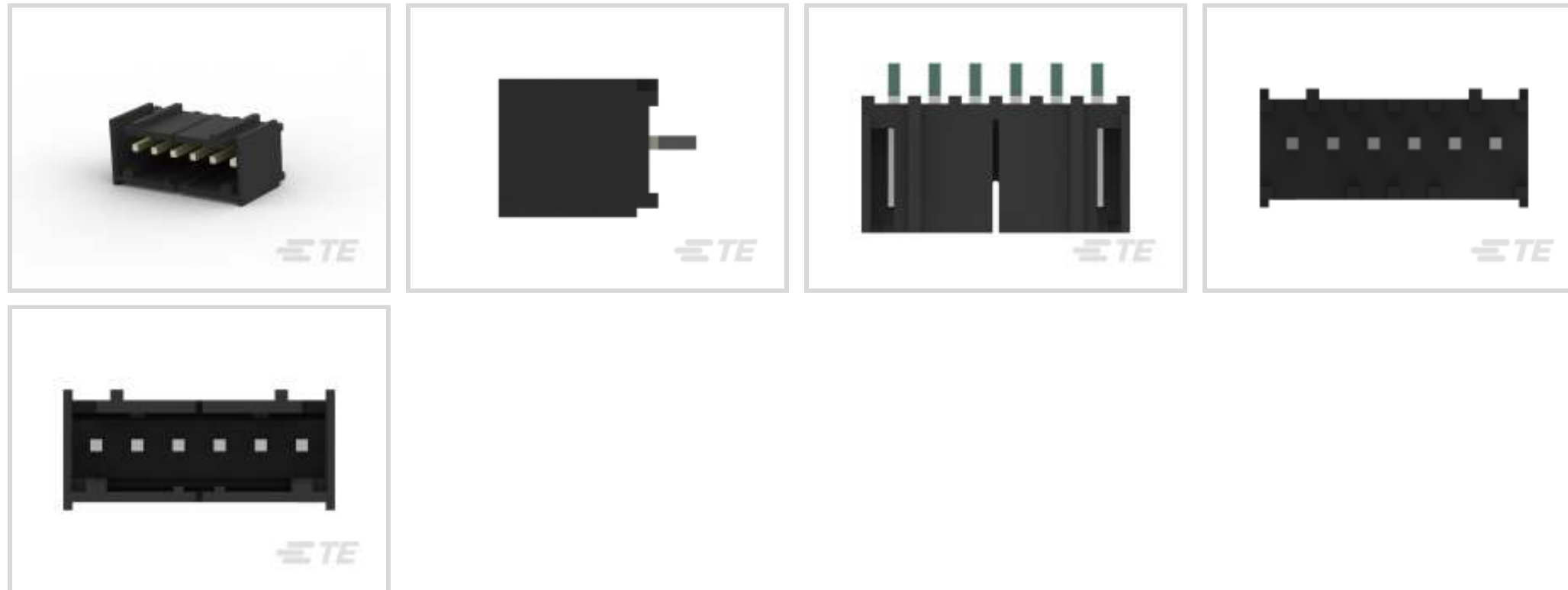

Rectangular Power Connector Type: **Header**

Connector & Housing Type: **Plug**

Connector System: **Wire-to-Board**

Number of Positions: **6**

Centerline (Pitch): **3.96 mm [.156 in]**

Features

Product Type Features

Header Type	Fully Shrouded
Rectangular Power Connector Type	Header
Connector & Housing Type	Plug
Connector System	Wire-to-Board
Sealable	No
Connector & Contact Terminates To	Printed Circuit Board

Configuration Features

Number of Positions	6
PCB Mount Orientation	Vertical
Number of Power Positions	6
Number of Rows	1

Electrical Characteristics

Operating Voltage	600 VAC
-------------------	---------

Body Features



Connector Profile	Standard
-------------------	----------

Contact Features

Mating Post Length	7.62 mm[.3 in]
PCB Contact Termination Area Plating Material Thickness	1 μ m[39.37 μ in]
Contact Layout	Inline
Contact Underplating Material Thickness	1.27 μ m[50 μ in]
Contact Mating Area Plating Material	Tin
Contact Mating Area Plating Material Finish	Matte
Contact Underplating Material	Nickel
Contact Base Material	Copper Alloy
Contact Current Rating (Max)	7 A
Contact Retention Within Housing	Without
Contact Type	Pin
PCB Contact Termination Area Plating Material	Tin
Contact Mating Area Plating Material Thickness	3.81 – 8.89 μ m[150 – 350 μ in]

Termination Features

Termination Post & Tail Length	2.92 mm[.115 in]
Termination Method to Printed Circuit Board	Through Hole - Solder

Mechanical Attachment

Strain Relief	Without
Mating Alignment Type	Polarization
Mating Retention	With
Mating Alignment	With
PCB Mount Alignment	Without
Panel Mount Feature	Without
PCB Mount Retention	Without
Mating Retention Type	Latch Detent
Connector Mounting Type	Board Mount

Housing Features

Centerline (Pitch)	3.96 mm[.156 in]
Housing Color	Black
Housing Material	Polyester



Dimensions

Connector Height	13.34 mm[.525 in]
PCB Thickness (Recommended)	1.57 mm[.062 in]
Product Length	26.16 mm[1.03 in]
Compatible Insulation Diameter Range	.89 – 1.53 mm

Usage Conditions

Operating Temperature Range	-55 – 105 °C[-67 – 221 °F]
-----------------------------	----------------------------

Operation/Application

Circuit Application	Power
---------------------	-------

Industry Standards

CSA Rating	Certified, LR 7189
UL Rating	Recognized
Agency/Standard	CSA, UL
Approved Standards	UL E28476
UL Flammability Rating	UL 94V-0
Glow Wire Rating	Standard Part - Not Glow Wire

Packaging Features

Packaging Quantity	500
Packaging Method	Bag

Product Compliance

[For compliance documentation, visit the product page on TE.com>](#)

EU RoHS Directive 2011/65/EU	Compliant
EU ELV Directive 2000/53/EC	Compliant
China RoHS 2 Directive MIIT Order No 32, 2016	No Restricted Materials Above Threshold
EU REACH Regulation (EC) No. 1907/2006	Current ECHA Candidate List: JUNE 2023 (235) Candidate List Declared Against: JUNE 2023 (235) Does not contain REACH SVHC
Halogen Content	Not Low Halogen - contains Br or Cl > 900 ppm.
Solder Process Capability	Wave solder capable to 240°C

Product Compliance Disclaimer



This information is provided based on reasonable inquiry of our suppliers and represents our current actual knowledge based on the information they provided. This information is subject to change. The part numbers that TE has identified as EU RoHS compliant have a maximum concentration of 0.1% by weight in homogenous materials for lead, hexavalent chromium, mercury, PBB, PBDE, DBP, BBP, DEHP, DIBP, and 0.01% for cadmium, or qualify for an exemption to these limits as defined in the Annexes of Directive 2011/65/EU (RoHS2). Finished electrical and electronic equipment products will be CE marked as required by Directive 2011/65/EU. Components may not be CE marked. Additionally, the part numbers that TE has identified as EU ELV compliant have a maximum concentration of 0.1% by weight in homogenous materials for lead, hexavalent chromium, and mercury, and 0.01% for cadmium, or qualify for an exemption to these limits as defined in the Annexes of Directive 2000/53/EC (ELV). Regarding the REACH Regulation, the information TE provides on SVHC in articles for this part number is based on the latest European Chemicals Agency (ECHA) 'Guidance on requirements for substances in articles' posted at this URL: <https://echa.europa.eu/guidance-documents/guidance-on-reach>

Compatible Parts



TE Part # CAT-103156-WBHSM
Receptacle Housing: Wire-to-Board, with Mating Alignment, SL156



TE Part # 643067-6
06P MTA156 MOLDED COVER



TE Part # 640551-6
06P MTA156 COVER



TE Part # 3-640428-6
06P MTA156 CONN ASSY 22AWG RED



TE Part # 3-643817-6
06P MTA156 CONN ASSY 18AWG ORA



TE Part # 3-643819-6
06P MTA156 CONN ASSY 22AWG RED



TE Part # 3-644466-6
06P MTA156 CONN ASSY 20AWG YEL



TE Part # 3-640599-6
06P MTA156 CONN ASSY 18AWG ORA



TE Part # 3-640427-6
06P MTA156 CONN ASSY 20AWG YEL



TE Part # 3-644465-6
06P MTA156 CONN ASSY 18AWG ORA



TE Part # 640643-6
06P MTA156 COVER F/T



TE Part # 3-640431-6
06P MTA156 CONN ASSY 18AWG ORA



TE Part # 3-643818-6
06P MTA156 CONN ASSY 20AWG YEL



TE Part # 3-644878-6
06P MTA156 ASSY ON TAPE LF



TE Part # 3-640600-6
06P MTA156 CONN ASSY 20AWG LF



TE Part # 3-640433-6
06P MTA156 CONN ASSY 22AWG RED



TE Part # 643071-6
06P MTA156 FD-THRU COVER



TE Part # 3-644860-6
06P MTA156 CONN ASSY 18AWG LF



TE Part # 3-644461-6
06P MTA156 CONN ASSY 18AWG LF



TE Part # 3-640432-6
06P MTA156 CONN ASSY 20AWG YEL

Also in the Series | MTA 156

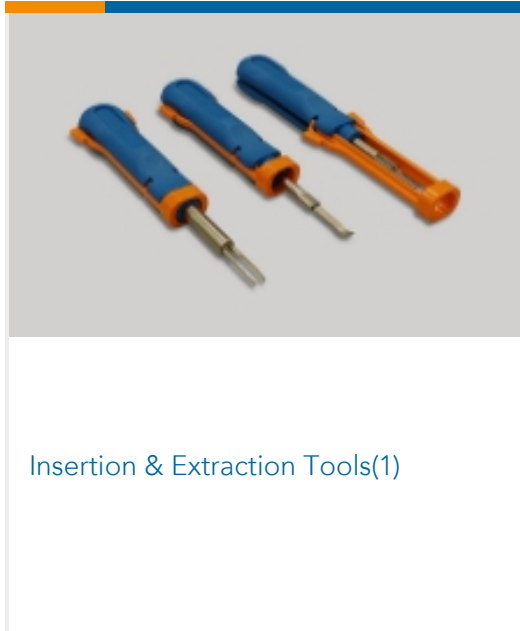

Insertion & Extraction Tools(1)

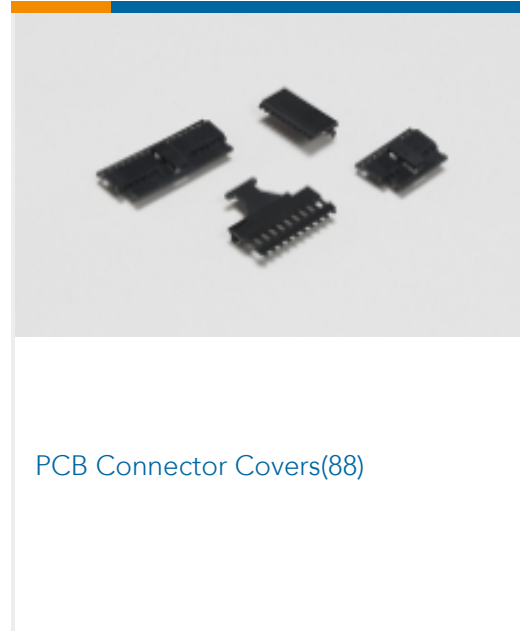

PCB Connector Covers(88)

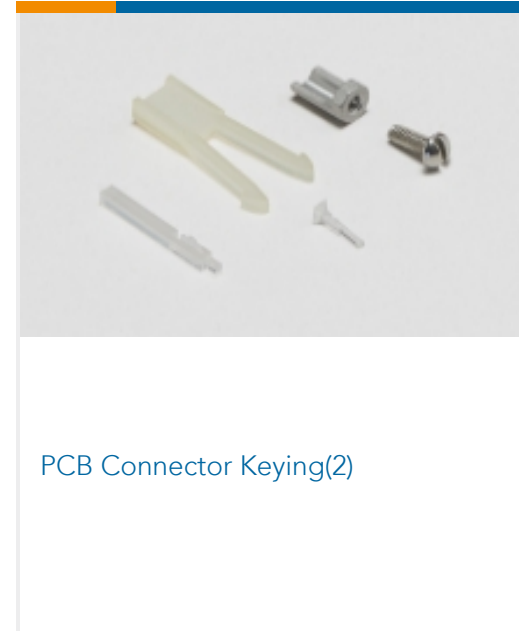

PCB Connector Keying(2)



PCB Connector Mounting(1)



PCB Headers & Receptacles(316)

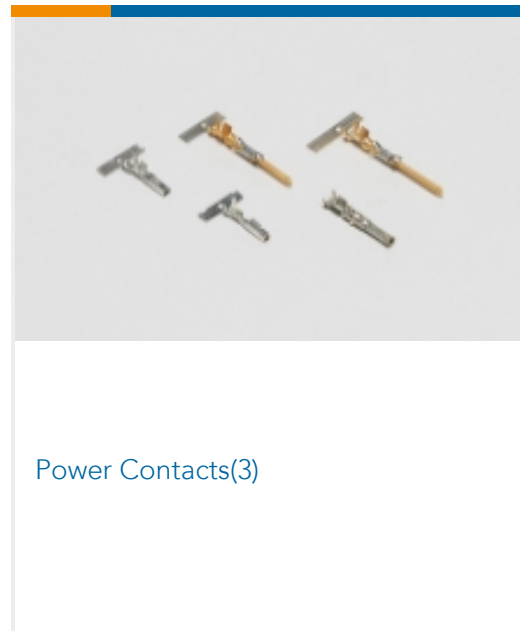

Power Contacts(3)

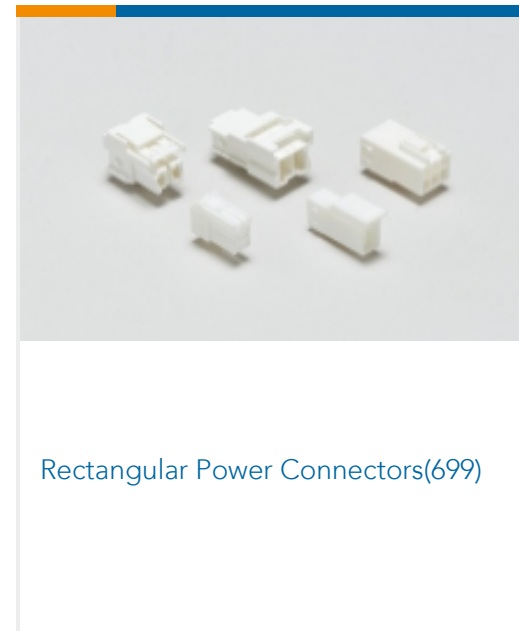

Rectangular Power Connectors(699)

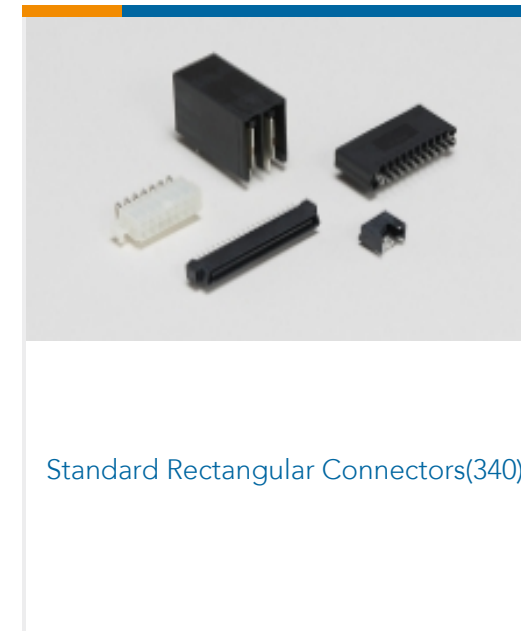

Standard Rectangular Connectors(340)

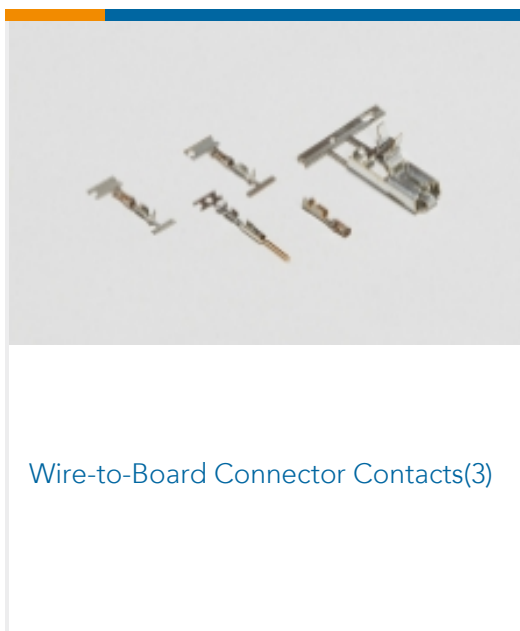

Wire-to-Board Connector Contacts(3)

Customers Also Bought



TE Part #5747150-7
09 RCPT SP/FMS INSRT



TE Part #2-644486-4
Polyester Vertical PCB Header: 2.54 mm, Shrouded, MTA 100



TE Part #1-175194-2
DYNAMIC D-3 REC CONT/S AU 0.38



TE Part #5748026-1
15 PLUG SP/FMS (IN,SL)



TE Part #530153-2
TDM SPRING SHUNT ASSY 2 POS



TE Part #917780-1
2.5 S.D.L POST HDR ASY 2P STD



TE Part #2-647127-2
02P MTA156 SHRD HDR ASSY LF



TE Part #1625881-6
1W STD M/OX 2% 100R

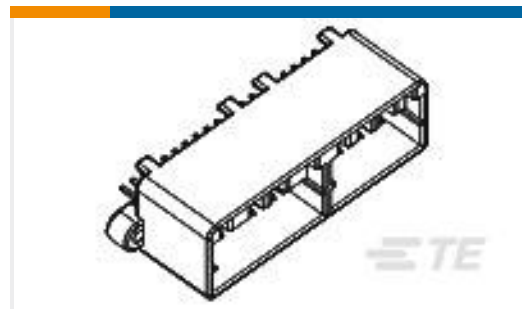

TE Part #175977-2
040 MLC CAP ASS'Y V 36P

Documents

Product Drawings

[06P MTA156 SHRD HDR ASSY SQ SN](#)

English

CAD Files

[3D PDF](#)

3D

Customer View Model

[ENG_CVM_CVM_2-647123-6_D.2d_dxf.zip](#)

English

Customer View Model

[ENG_CVM_CVM_2-647123-6_D.3d_igs.zip](#)

English

Customer View Model

[ENG_CVM_CVM_2-647123-6_D.3d_stp.zip](#)

English

By downloading the CAD file I accept and agree to the [Terms and Conditions](#) of use.

Product Specifications

[Application Specification](#)

English