

TP02 Series

Exceptional Endurance

10 Million Operations

Lighter Touch, Smooth Operation

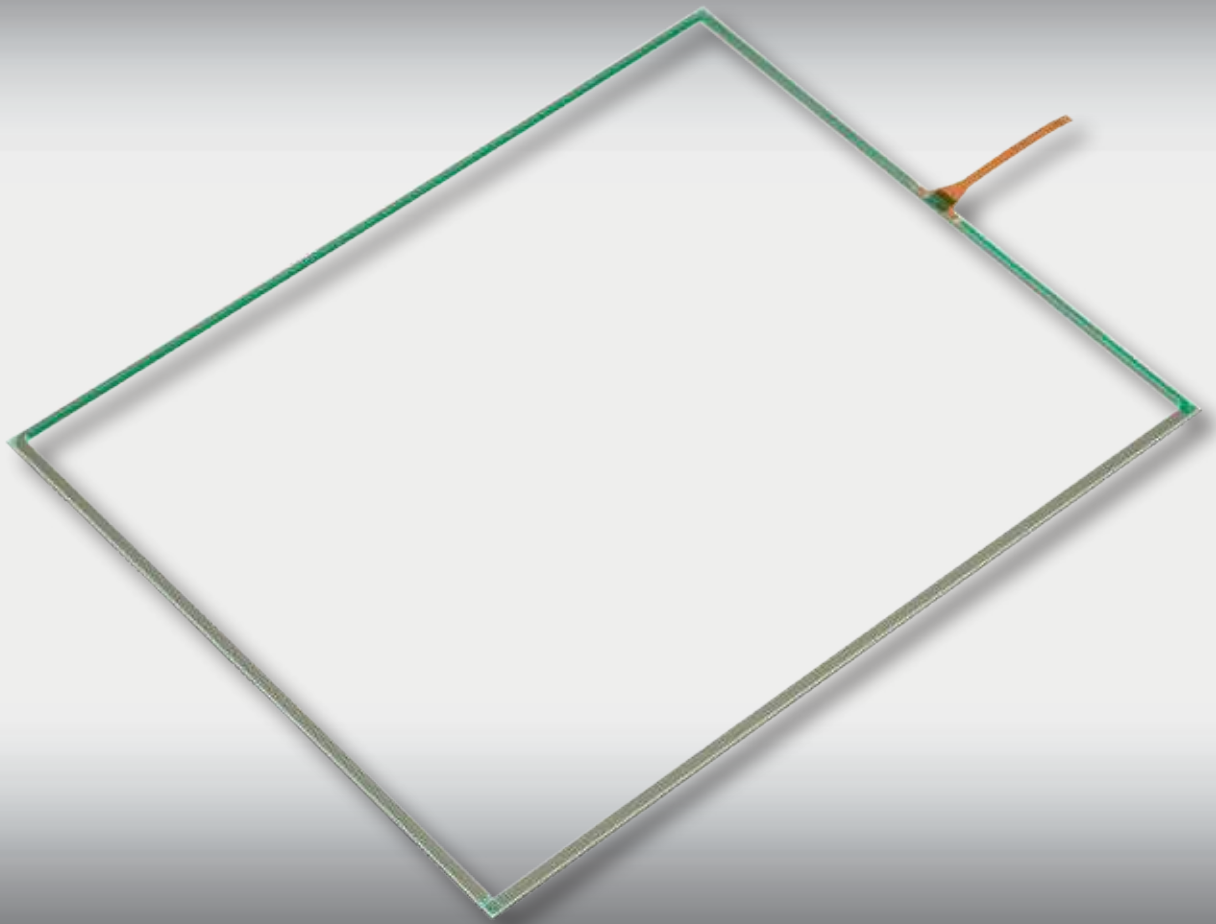

4-Wire Analog Touch Screens

General Specifications

Electrical Capacity (Resistive Load)

Power Level: 1mA @ 5.5V DC (resistive load)

Other Ratings

- XY Resistive Value:** 250 ~ 850Ω; Wide: 120 ~ 1,500Ω
- Linearity:** ±1.5% maximum
- Insulation Impedance:** 10MΩ minimum @ 25V DC
- Expected Operational Life:** Writing: 50,000 operations minimum (approximately 30mm movement with stylus)
Tapping: 10,000,000 operations minimum (silicone rubber 60°)
- Touch Activation Force:** 0.02 ~ 1.0N maximum
- Chattering Time:** 10 milliseconds maximum
- Light Transmission:** 80% typical (Touch Panel portion)
- Surface Hardness:** 3H minimum (JIS K5400)

Environmental Data

- Operating Temperature Range:** -20°C ~ +70°C (-4°F ~ +158°F)
- Storage Temperature Range:** -40°C ~ +80°C (-40°F ~ +176°F)
- Relative Humidity:** +40°C (+104°F), humidity 90%, 240 hours

Note: Values are determined by NKK's individual specification tests in a controlled environment, and do not certify that the product supports simultaneous multiple conditions.

Applications

- Industrial Automation
- ATMs
- Broadcast
- Communication Systems
- Medical Equipment
- Food Service
- POS, Cash Registers
- Gaming/Entertainment

Specializing in Custom Products

- Custom sizes for Resistive Touch Screens
- Capability to attach touch screens to LCDs or other components
- Specializing in custom construction such as film plus film combinations
- Fingerprint resistant, high transmittance films

Cross Section View of Touch Screen

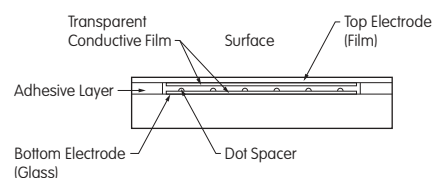

Distinctive Characteristics

- Exceptional durability and endurance promote the TP02 Series as the perfect partner for integrating with devices intended for repetitive use
- Reliable response to slightest input pressure. Assures dependable detection of touch operations, even when input with rapid succession.
- Expanded design capabilities in a variety of sizes and relatively low cost. Narrow frames available.
- Choice of input methods: finger, gloved hand or stylus
- Glare resistant surface reduces reflection from fluorescent lighting, sunlight
- Anti-Newton Ring (ANR) Technology eliminates many of the typical visual artifacts for analog types
- Hard resin coating on film's surface ensures excellent protection against scratches or damage
- Analog touch screen combined with optional controller board device driver on computer enables operations same as with a mouse by touching screen panel
- FPC metal tail ensures the reliability of contact to the connector

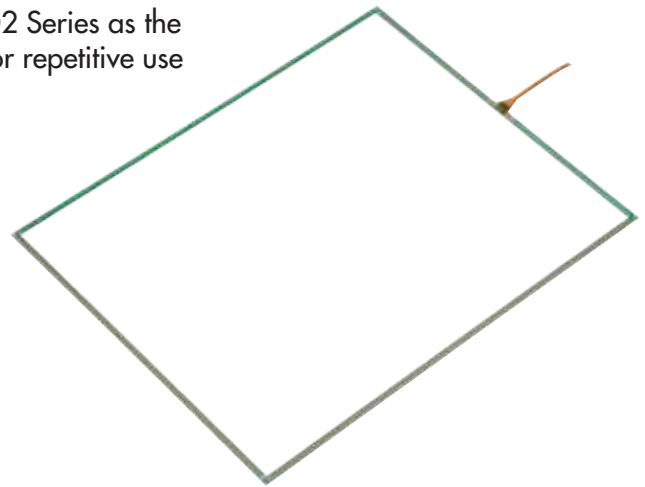

Controller Board for Single Touch Screens

DISTINCTIVE CHARACTERISTICS

- Engineered to partner with TP02 single touch screens, resulting in smooth, effortless operation
- Supports USB and RS232C
- Compatible with versions of Windows OS (7, 8 and 10)
- Wide selection of compatible screen sizes
- Available as a separate item and sold individually

NKK also offers controller boards for multi-touch functionality. Contact sales department for more information and technical data.

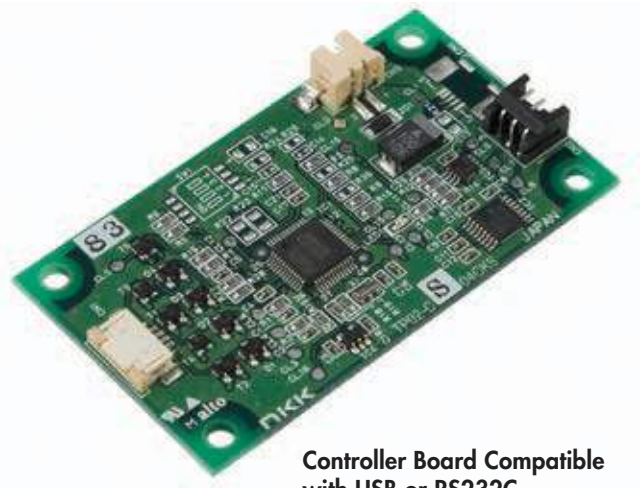

Controller Board Compatible with USB or RS232C

TYPICAL TOUCH SCREEN ORDERING EXAMPLE

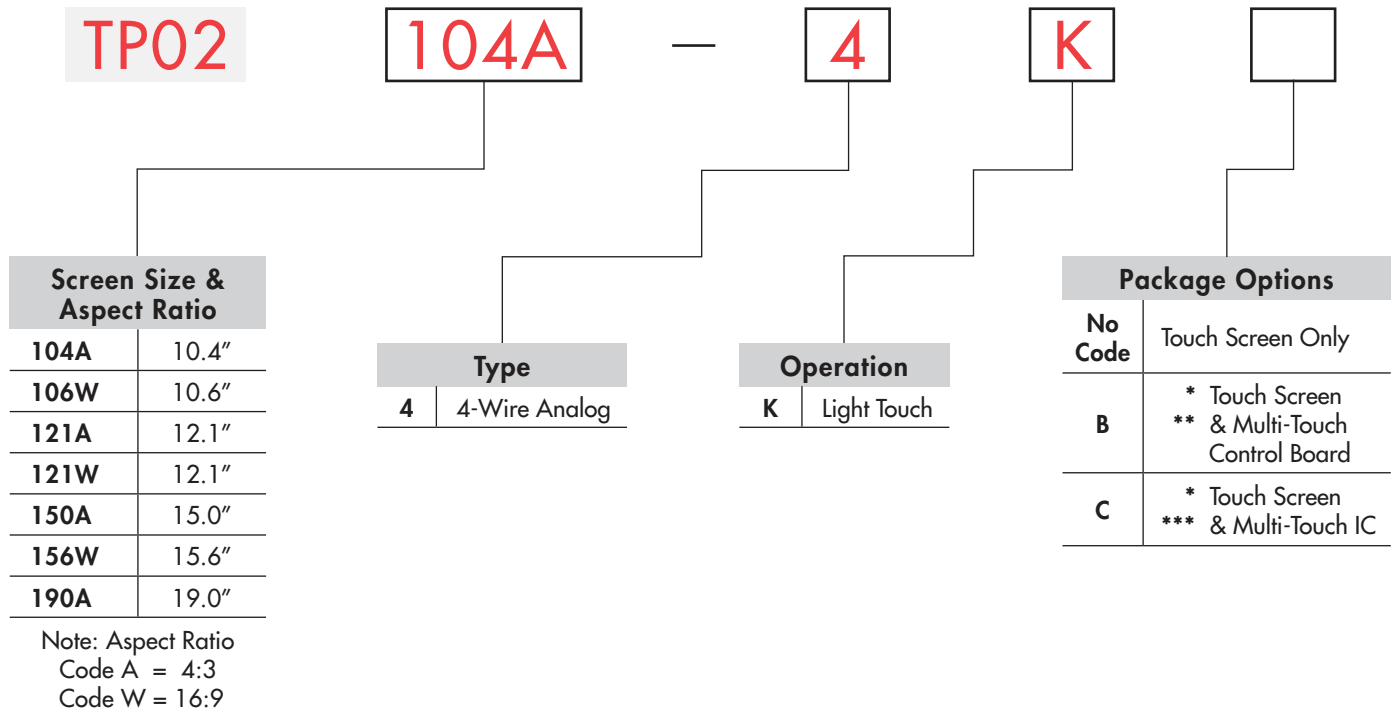

DESCRIPTION FOR TYPICAL ORDERING EXAMPLE

TP02104A-4K

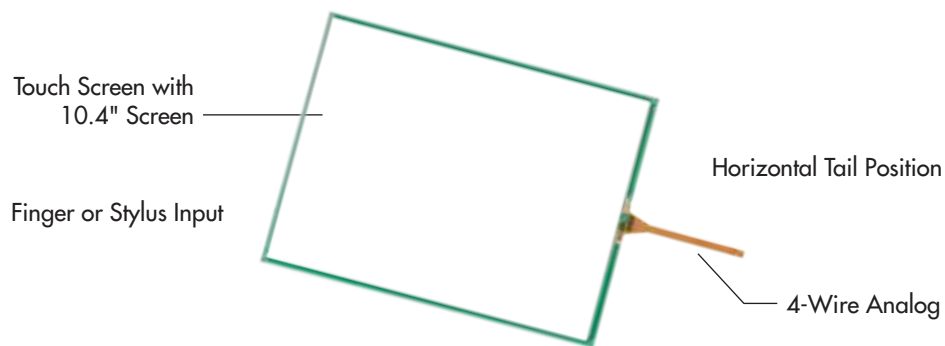





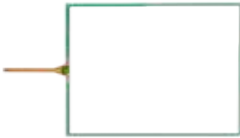

* Controller boards and IC chips for multi-touch touch screens are available only with package options. Controller boards for single touch screens are available separately. See pages 13- 14.

** Package Option B (Touch Screen & Multi-Touch Control Board) is primarily for product evaluation purposes.

*** Package Option C (Touch Screen & Multi-Touch IC) is primarily for use *after* product evaluation using the touch screen and control board; Option C is designed for use with the customer's PCB once the IC has been installed.

PART NUMBERS & DESCRIPTIONS

			
TP02104A-4K	TP02106W-4K	TP02121A-4K	TP02121W-4K
			
TP02150A-4K	TP02156W-4K	TP02190A-4K	

4-Wire Analog Touch Screens

Part Number	Screen Size in Inches	Key Area Dimensions	Viewing Area Dimensions	External Dimensions	Panel Thickness	Terminal Detail 4 Pin .039" (1.0mm) Pitch
TP02104A-4K	10.4	8.315" x 6.236" (211.2mm x 158.4mm)	8.465" x 6.394" (215.0mm x 162.4mm)	8.882" x 6.748" (225.6mm x 171.4mm)	.083" (2.1mm)	Length 3.150" (80.0mm)
TP02106W-4K	10.6	9.071" x 5.441" (230.4mm x 138.2mm)	9.189" x 5.563" (233.4mm x 141.3mm)	9.756" x 6.094" (247.8mm x 154.8mm)	.083" (2.1mm)	Length 3.150" (80.0mm)
TP02121A-4K	12.1	9.677" x 7.256" (245.8mm x 184.3mm)	9.827" x 7.406" (249.6mm x 188.1mm)	10.236" x 7.795" (260.0mm x 198.0mm)	.083" (2.1mm)	Length 3.150" (80.0mm)
TP02121W-4K	12.1	10.280" x 6.425" (261.12mm x 163.2mm)	10.404" x 6.551" (264.26mm x 166.4mm)	10.827" x 6.929" (275.0mm x 176.0mm)	.083" (2.1mm)	Length 3.150" (80.0mm)
TP02150A-4K	15.0	11.972" x 8.980" (304.1mm x 228.1mm)	12.130" x 9.138" (308.1mm x 232.1mm)	12.669" x 9.665" (321.8mm x 245.5mm)	.083" (2.1mm)	Length 3.059" (77.7mm)
TP02156W-4K	15.6	13.551" x 7.618" (344.2mm x 193.5mm)	13.681" x 7.748" (347.5mm x 196.8mm)	14.276" x 8.433" (362.6mm x 214.2mm)	.083" (2.1mm)	Length 3.150" (80.0mm)
TP02190A-4K	19.0	14.815" x 11.850" (376.3mm x 301.0mm)	15.039" x 12.102" (382.0mm x 307.4mm)	15.571" x 12.638" (395.5mm x 321.0mm)	.083" (2.1mm)	Length 3.150" (80.0mm)

TYPICAL 10.4 DIMENSIONS

4-Wire with Horizontal Tail

Aspect Ratio 4:3

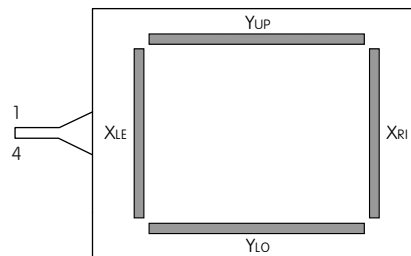
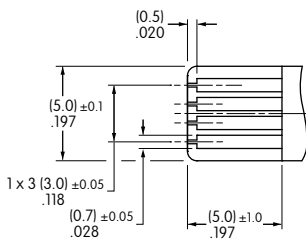
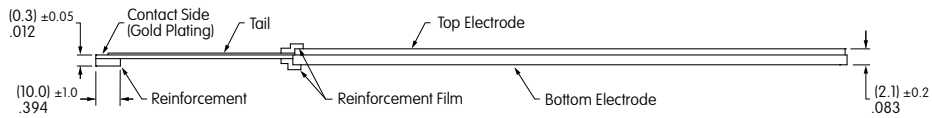
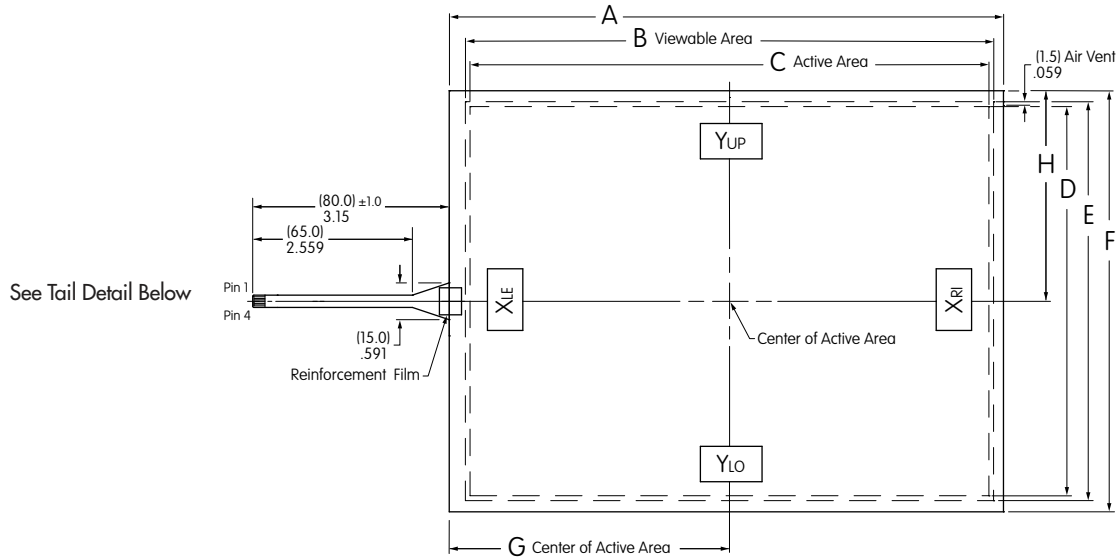

YUP, YLO: Bottom Electrode Terminal
XLE, XRI: Top Electrode Terminal

Pins	Signal
1	Y _{UP}
2	Y _{LO}
3	X _{LE}
4	X _{RI}

Typical Dimensions

Part Number	Screen Size in Inches	Dim A	Dim B Viewable Area	Dim C Active Area	Dim D Active Area	Dim E Viewable Area	Dim F	Dim G Center of Active Area (Horizontal)	Dim H Center of Active Area (Vertical)
TP02104A-4K	10.4	8.882" (225.6 ±0.3mm)	8.465" (215.0mm)	8.315" (211.2mm)	6.236" (158.4mm)	6.394" (162.4mm)	6.748" (171.4 ±0.3mm)	4.492" (114.1mm)	3.374" (85.7mm)

TYPICAL 10.6 DIMENSIONS

4-Wire Wide Type with Horizontal Tail

Aspect Ratio 16:9

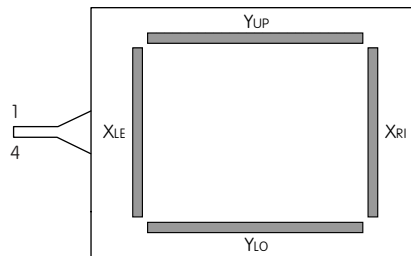
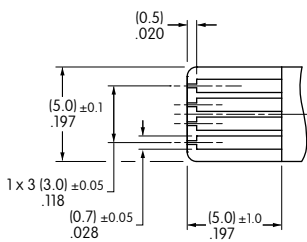
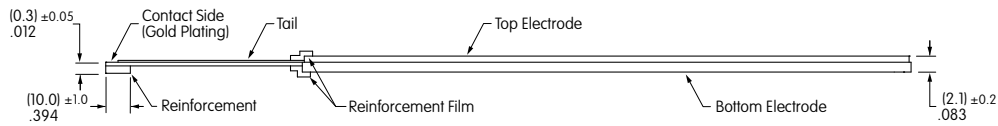
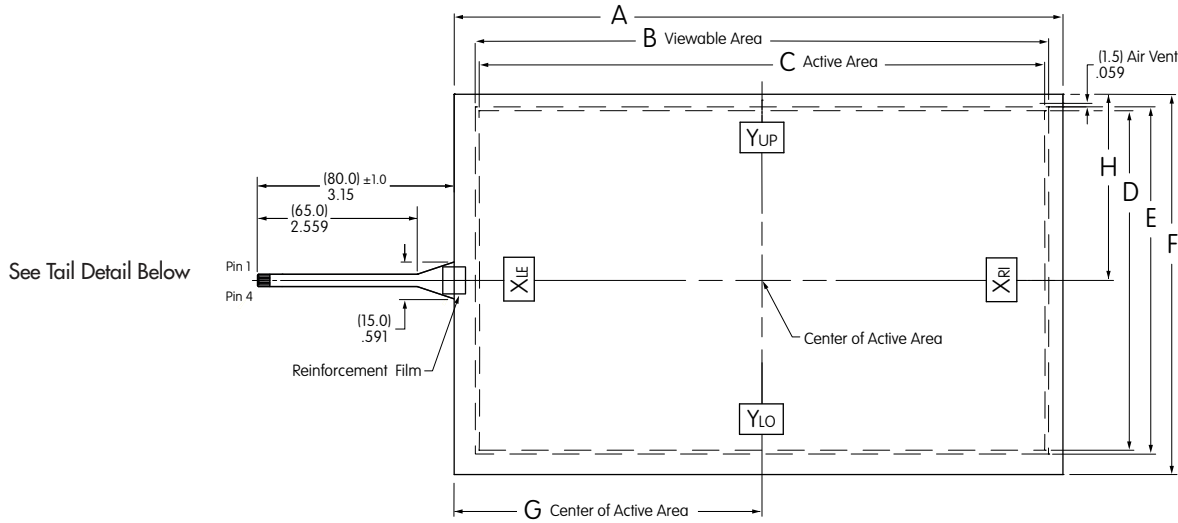

Pins	Signal
1	Y _{UP}
2	Y _{LO}
3	X _{LE}
4	X _{RI}

Y_{UP}, Y_{LO}: Bottom Electrode Terminal
X_{LE}, X_{RI}: Top Electrode Terminal

Typical Dimensions

Part Number	Screen Size in Inches	Dim A	Dim B Viewable Area	Dim C Active Area	Dim D Active Area	Dim E Viewable Area	Dim F	Dim G Center of Active Area (Horizontal)	Dim H Center of Active Area (Vertical)
TP02106W-4K	10.6	9.756" (247.8mm)	9.189" (233.4mm)	9.071" (230.4mm)	5.441" (138.2mm)	5.563" (141.3mm)	6.094" (154.8±0.3mm)	4.933" (125.3mm)	3.047" (77.4mm)

TYPICAL 12.1 DIMENSIONS

4-Wire with Horizontal Tail

Aspect Ratio 4:3

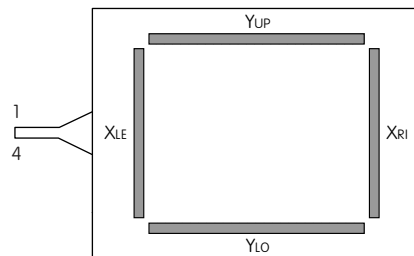
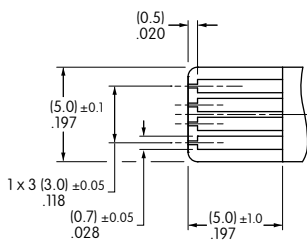
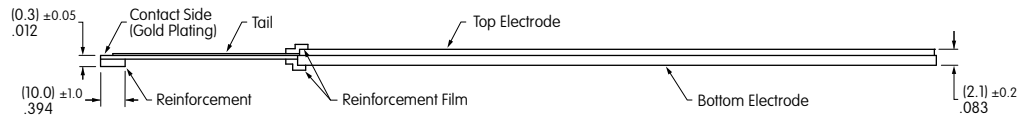
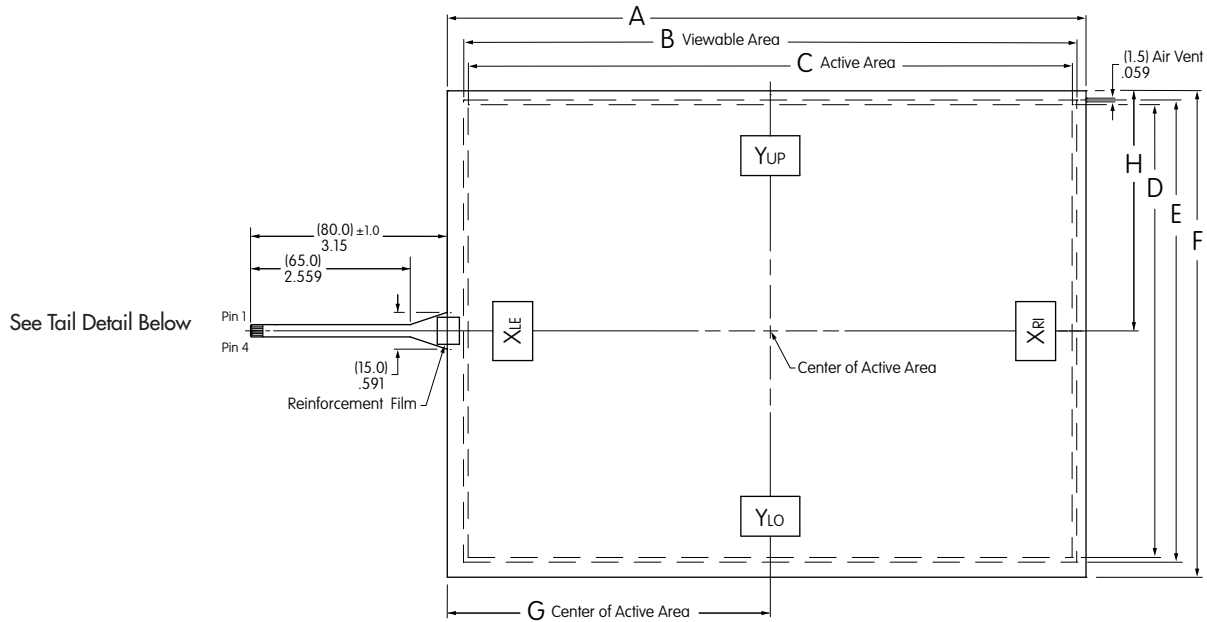

YUP, YLO: Bottom Electrode Terminal
XLE, XRI: Top Electrode Terminal

Pins	Signal
1	Y _{UP}
2	Y _{LO}
3	X _{LE}
4	X _{RI}

Typical Dimensions

Part Number	Screen Size in Inches	Dim A	Dim B Viewable Area	Dim C Active Area	Dim D Active Area	Dim E Viewable Area	Dim F	Dim G Center of Active Area (Horizontal)	Dim H Center of Active Area (Vertical)
TP02121A-4K	12.1	10.236" (260.0±0.3mm)	9.827" (249.6mm)	9.677" (245.8mm)	7.256" (184.3mm)	7.406" (188.1mm)	7.795" (198.0±0.3mm)	5.177" (131.5mm)	3.898" (99.0mm)

TYPICAL 12.1 DIMENSIONS

4-Wire Wide Type with Horizontal Tail

Aspect Ratio 16:9

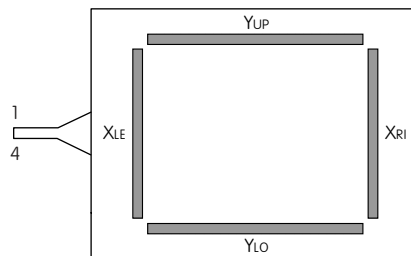
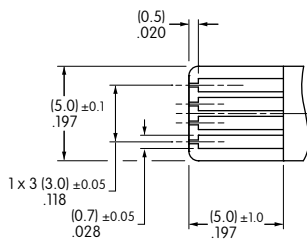
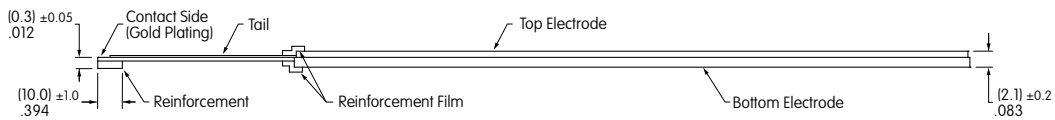
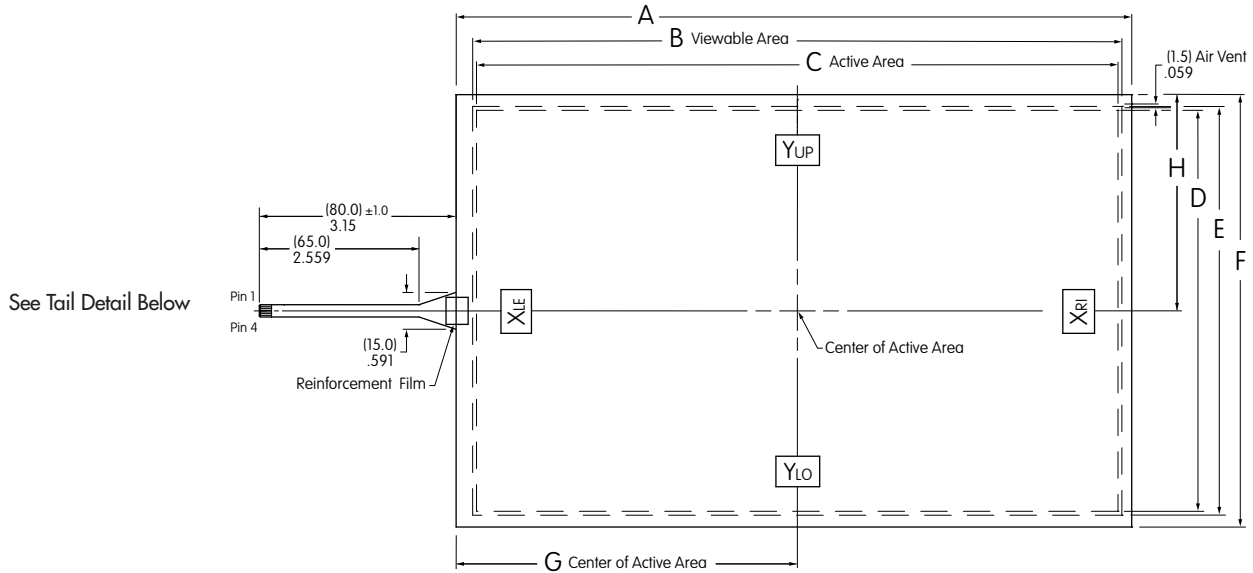

Y_{UP}, Y_{LO}: Bottom Electrode Terminal
X_{LE}, X_{RI}: Top Electrode Terminal

Pins	Signal
1	Y _{UP}
2	Y _{LO}
3	X _{LE}
4	X _{RI}

Typical Dimensions

Part Number	Screen Size in Inches	Dim A	Dim B Viewable Area	Dim C Active Area	Dim D Active Area	Dim E Viewable Area	Dim F	Dim G Center of Active Area (Horizontal)	Dim H Center of Active Area (Vertical)
TP02121W-4K	12.1	10.827" (275.0±0.3mm)	10.404" (264.26mm)	10.280" (261.12mm)	6.425" (163.2mm)	6.551" (166.4mm)	6.929" (176.0±0.3mm)	5.468" (138.89mm)	3.465" (88.0mm)

TYPICAL 15.0 DIMENSIONS

4-Wire with Horizontal Tail

Aspect Ratio 4:3

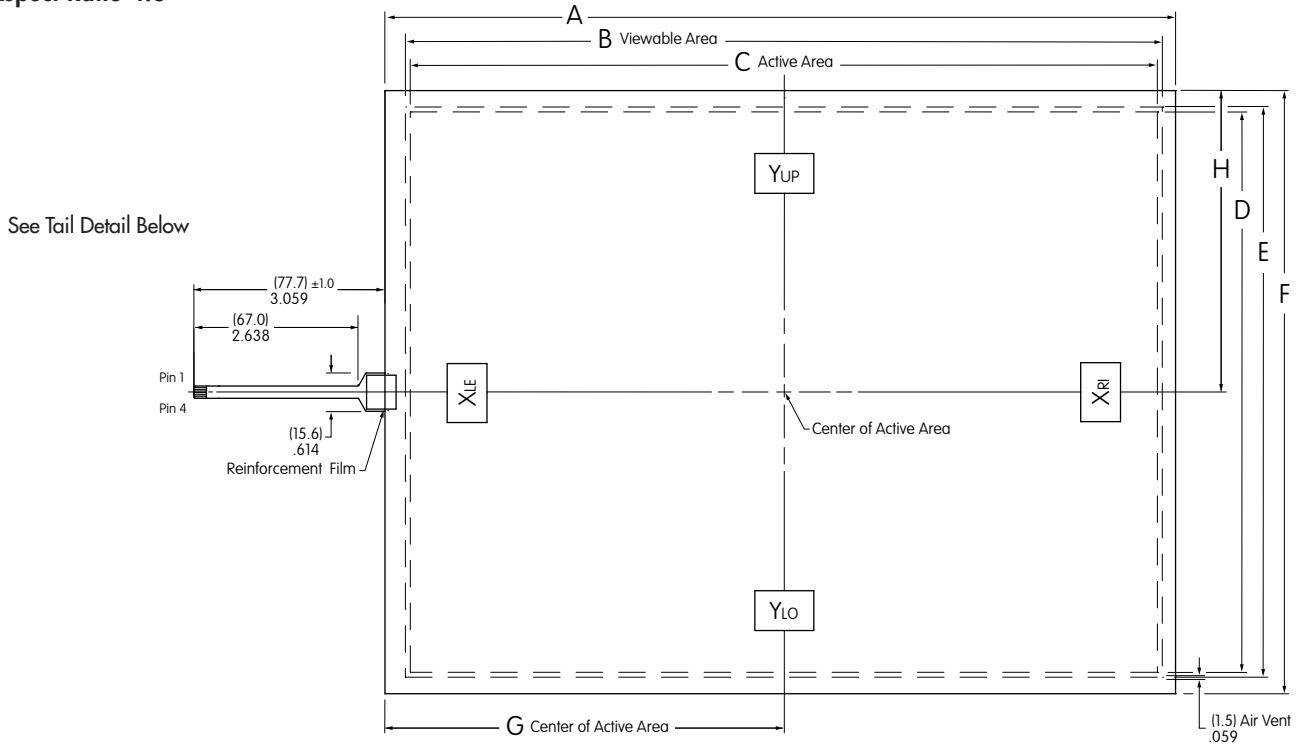

See Tail Detail Below

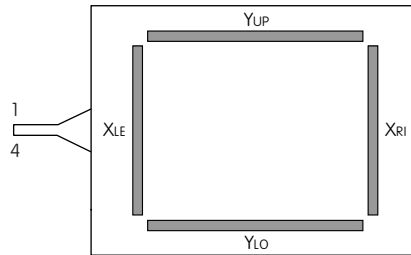
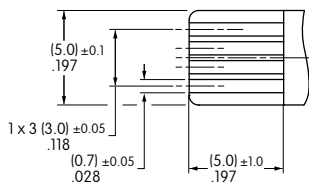
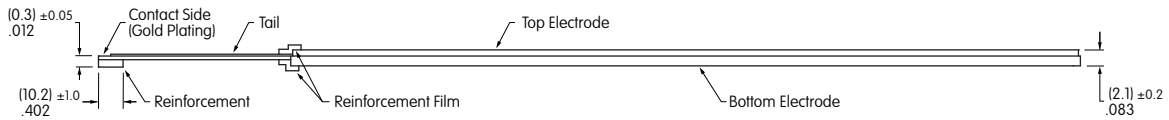

YUP, YLO: Bottom Electrode Terminal
XLE, XRI: Top Electrode Terminal

Pins	Signal
1	Y _{UP}
2	Y _{LO}
3	X _{LE}
4	X _{RI}

Typical Dimensions

Part Number	Screen Size in Inches	Dim A	Dim B Viewable Area	Dim C Active Area	Dim D Active Area	Dim E Viewable Area	Dim F	Dim G Center of Active Area (Horizontal)	Dim H Center of Active Area (Vertical)
TP02150A-4K	15.0	12.669" (321.8±0.3mm)	12.130" (308.1mm)	11.972" (304.1mm)	8.980" (228.1mm)	9.138" (232.1mm)	9.665" (245.5±0.3mm)	6.398" (162.5mm)	4.833" (122.75mm)

TYPICAL 15.6 DIMENSIONS

4-Wire Wide Type with Horizontal Tail

Aspect Ratio 16:9

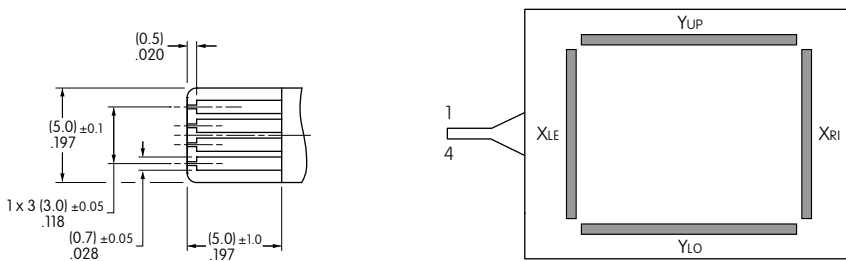
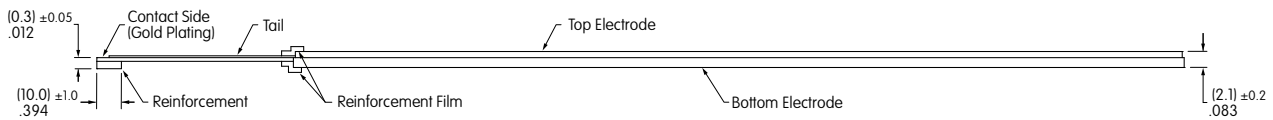
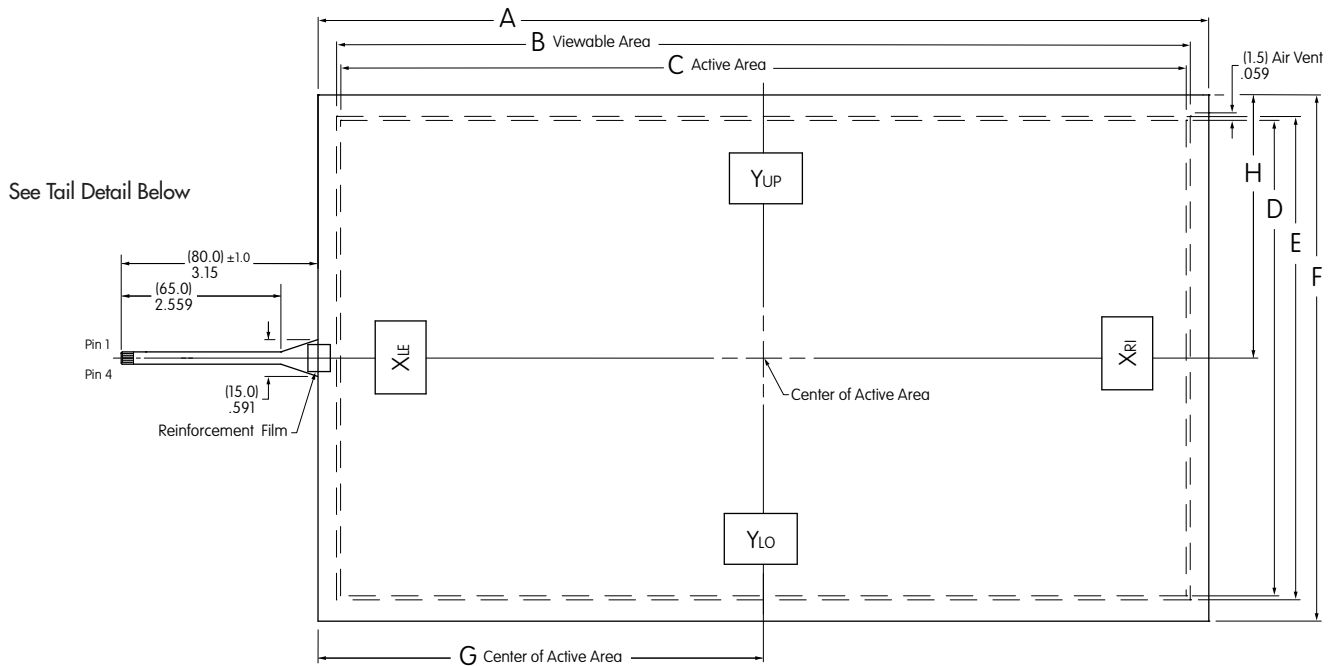

YUP, YLO: Bottom Electrode Terminal
XLE, XRI: Top Electrode Terminal

Pins	Signal
1	Y _{UP}
2	Y _{LO}
3	X _{LE}
4	X _{RI}

Typical Dimensions

Part Number	Screen Size in Inches	Dim A	Dim B Viewable Area	Dim C Active Area	Dim D Active Area	Dim E Viewable Area	Dim F	Dim G Center of Active Area (Horizontal)	Dim H Center of Active Area (Vertical)
TP02156AW-4	15.6	14.276" (362.6±0.3mm)	13.681" (347.5mm)	13.551" (344.2mm)	7.618" (193.5mm)	7.748" (196.8mm)	8.433" (214.2±0.3mm)	7.138" (181.3mm)	4.217" (107.1mm)

TYPICAL 19.0 DIMENSIONS

4-Wire with Horizontal Tail

Aspect Ratio 4:3

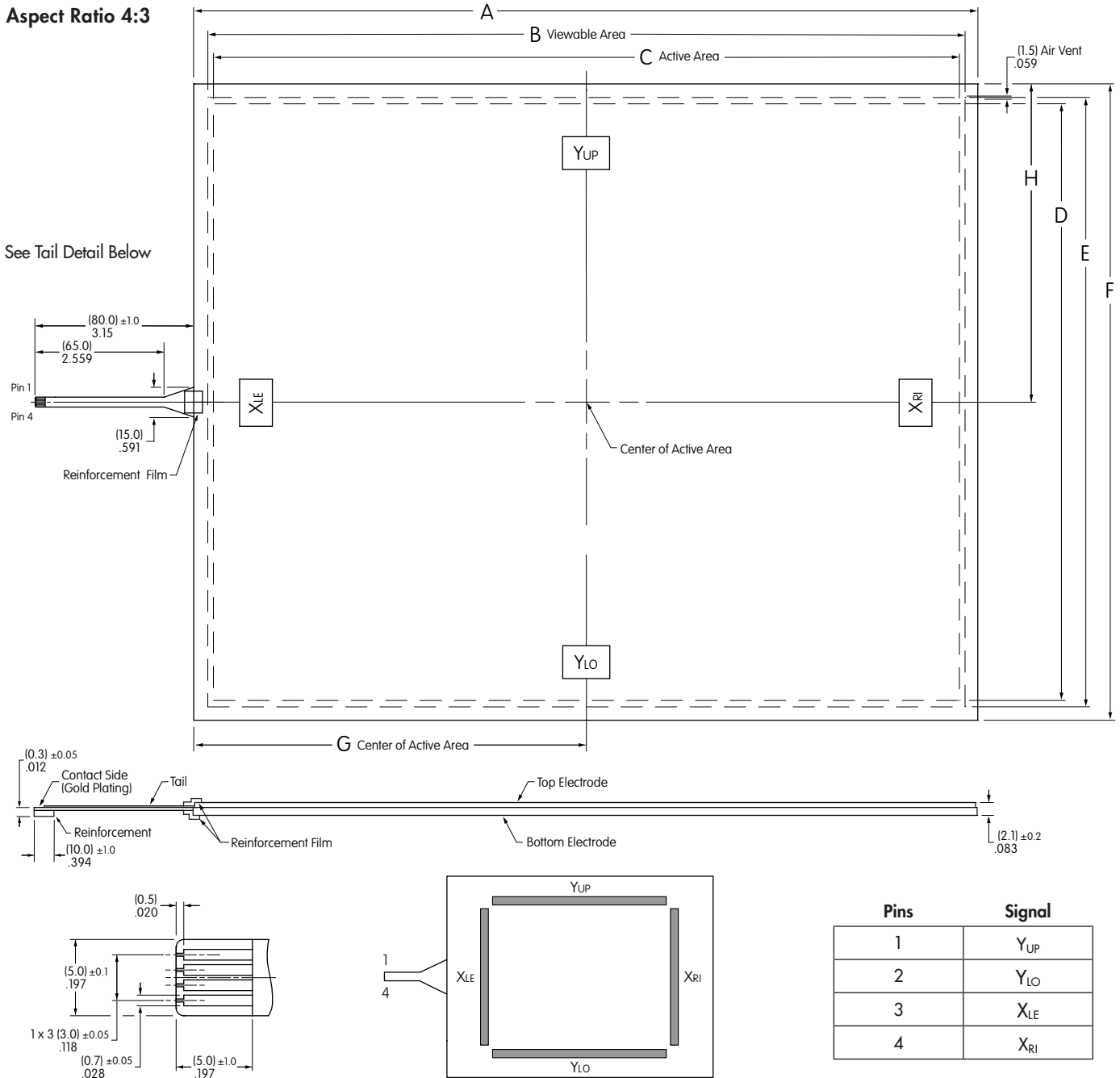

Y_{UP}, Y_{LO}: Bottom Electrode Terminal
X_{LE}, X_{RI}: Top Electrode Terminal

Typical Dimensions

Part Number	Screen Size in Inches	Dim A	Dim B Viewable Area	Dim C Active Area	Dim D Active Area	Dim E Viewable Area	Dim F	Dim G Center of Active Area (Horizontal)	Dim H Center of Active Area (Vertical)
TP02190A-4K	19.0	15.571" (395.5±0.3mm)	15.039" (382.0mm)	14.815" (376.3mm)	11.850" (301.0mm)	12.102" (307.4mm)	12.638" (321.0±0.3mm)	7.799" (198.1mm)	6.319" (160.5mm)

4-Wire Single Touch Screen Controller Boards & Drivers

DISTINCTIVE CHARACTERISTICS

- Compatible with Control Board USB
- Device Driver is *Windows 7, 8 & 10 Compatible; Windows XPe CE

System Configuration for USB

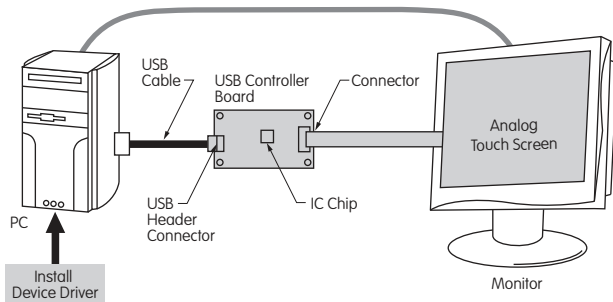

Available through NKK Switches

System Configuration for RS232C

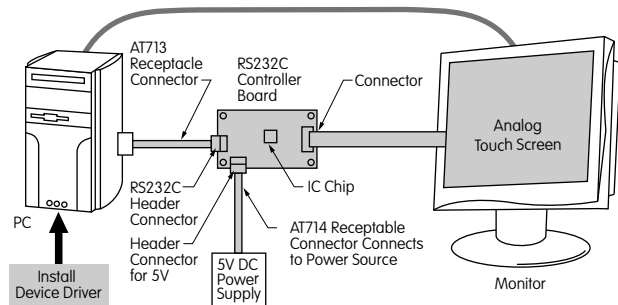

Available through NKK Switches

Controller Boards		
Part No.	Type	Communication Protocol
TP02CS04CKS	4-Wire	RS232C
TP02CU04CKS	4-Wire	USB

General Specifications		
Items	TP02CS04CKS	TP02CU04CKS
Interface	RS232C Standard	USB 2.0 Full Speed
Clock	16MHz	16MHz
Supply Voltage	5.0V	5.0V (USB Bus Power)
Resolution	10bit	10bit
Current Consumption	40mA maximum	100mA maximum
Communication Speed	9600 bps	—
Communication Format	Data Length: 8bit Parity: None Stop Bit: 1	—

For one touch wiring, the RS232C controller board comes with an analog 4-wire touch screen connector, an RS232C header connector, and a 5V power supply header connector. Receptacle connector AT713 with code connects to RS232C communication of the controller boards, and receptacle connector AT714 with code connects to the power source of the control boards.

Refer to product specifications before using TP02CS04CKS or TP02CU04CKS, available through NKK.

For inquiries regarding IC chips for single touch screens, or for technical data for the controller boards and drivers, contact NKK Switches engineering support personnel.

Absolute Maximum Ratings

Items	Symbols	Minimum	Maximum	Notes
Supply Voltage	V_{CC}	-0.3V	+5.5V	—
Input Voltage	V_{TP}	—	V_{CC}	Touch Screen Input
	* V_{RS}	-15V	+15V	RS232C
Operating Temperature	T_{OPR}	-20°C (-4°F)	+70°C (+158°F)	No Condensation
Storage Temperature	T_{STG}	-25°C (-13°F)	+85°C (+185°F)	No Condensation

* V_{RS} : For RS232C compatible models only

Recommended Values

Items	Symbols	Minimum	Typical	Maximum	Notes
Supply Voltage	V_{CC}	+4.75V	+5V	+5.25V	—
Operating Temperature	T_{OPR}	-20°C (-4°F)	—	+70°C (+158°F)	No Condensation

NKK's analog touch panels can be operated the same as PC mouse functions by combining a control board or device driver and an analog touch screen.

*Windows is a registered trademark of Microsoft Corporation.

Single Touch Screen Controller Board for RS232C

TP02CS04CKS

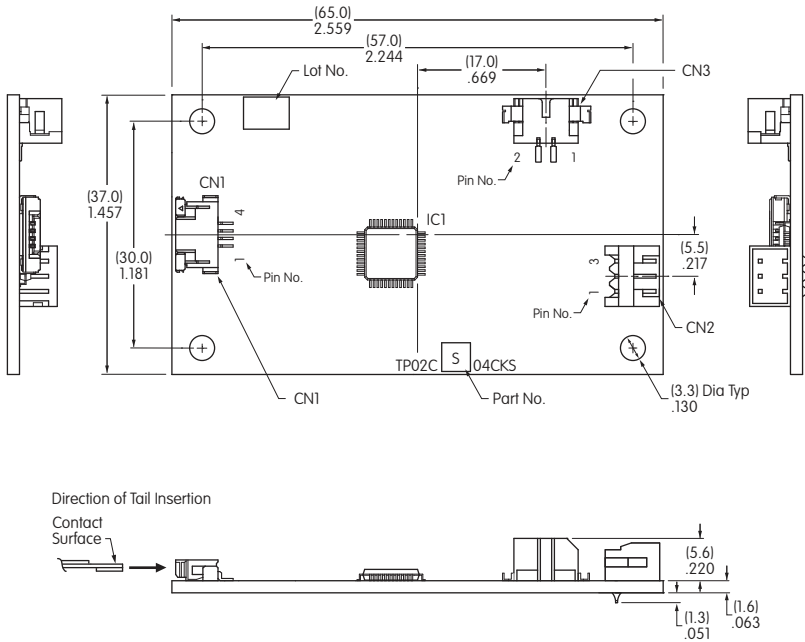

CN1 4-Wire Analog Touch Screen Connector - 4 Pins

Pin No.	Symbol	Terminal
1	Y0	Analog Touch Screen Y _{UP} or Y _{LO}
2	Y1	
3	X0	Analog Touch Screen X _{RI} or X _{LE}
4	X1	

CN2 RS232C Header Connector - 3 Pins

Control Board Side			Connection Terminal on PC Side
Pin No.	Symbol	Terminal	
1	RD	Received Data (IN)	Sent Data
2	SD	Sent Data (OUT)	Received Data
3	GND	GND	GND

CN3 Power Supply Header Connector - 2 Pins

Pin No.	Symbol	Terminal
1	V _{CC}	Power Supply Voltage
2	GND	GND

Single Touch Screen Controller Board for USB

TP02CU04CKS

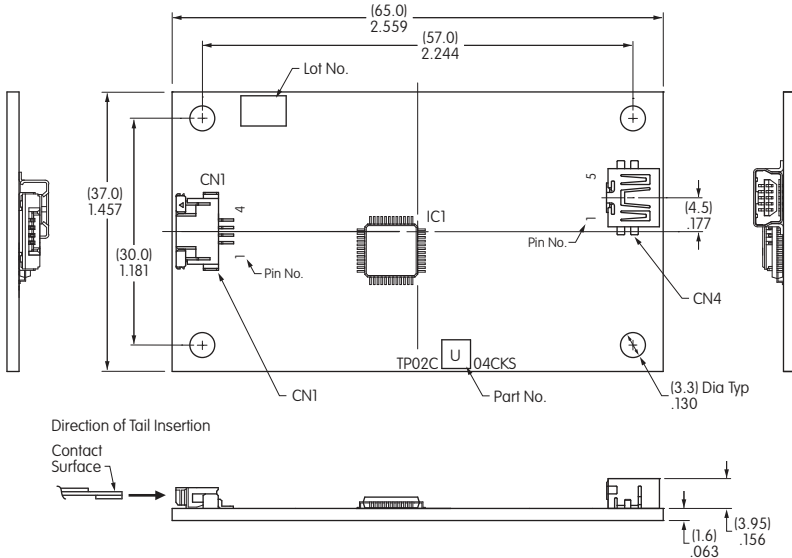

CN1 4-Wire Analog Touch Screen Connector - 4 Pins

Pin No.	Symbol	Terminal
1	Y0	Analog Touch Screen Y _{UP} or Y _{LO}
2	Y1	
3	X0	Analog Touch Screen X _{RI} or X _{LE}
4	X1	

CN4 USB Header Connector - 5 Pins

Pin No.	Symbol	Terminal
1	V _{CC}	USB V _{CC}
2	D-	USB D-
3	D+	USB D+
4	GND	USB GND
5	GND	Shield GND

OPTIONAL ACCESSORIES

AT713 Receptacle Connector

This Receptacle Connector with code connects to the TP02CS04CKS controller board to the PC for RS232C communications. The length of the cord can be specified by the customer. Excludes connector for the PC side.

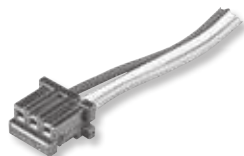

AT714 Receptacle Connector

AT714 is a Receptacle Connector with code to connect the TP02CS04CKS controller board to the power source. The length of the cord can be specified by the customer. For more details and dimensioned drawings, see Accessories in NKK's full line catalog or contact engineering support personnel.



STORAGE, HANDLING & INSTALLATION

Handling of Controller Board

- NKK Switches cannot guarantee the controller boards if used with other manufacturer's touch panels.
- Products are ESD sensitive and ESD protection is required.
- Power source should be activated after host and touch panel are connected.
- When inserting connector CN1 and touch panel tail, be sure the slider of connector CN1 is pulled. Do not pull more than 10 times.
- Do not customize or alter the product.
- NKK Switches reserves the right to make product improvement changes without notice.
- Do not use any commands other than the ones outlined in the specifications.
- Place the product away from noise source (such as inverter for LCD operation) since tail can be affected by noise.
- NKK is not responsible for results of using damaged equipment with the controller boards.
- Warranty for one year after delivery. NKK warrants the 4-wire touch panel when it is used with the NKK control board and driver.



Installation

- Avoid mechanical stress during installation, as it may cause deformation on the board.
- Do not pull, bend or apply force to the tail. Do not apply any mechanical stress to the tail area.
- Avoid vibration or shock.
- The touch screen mounting should not be loose. This may cause an adverse effect on detecting performance during operation.
- Ensure there are no burrs around the edges of the case or housing that can cause false actuation. The edges of the case or housing should not enter the keying area, as this may cause a malfunction.
- The case or housing and upper electrode should have a space of about 0.5mm to accommodate expansion or shrinkage due to temperature variances. If a shock barrier is used, do not press hard on the upper electrode area. Any shock barrier should be installed more than 0.6mm away from point A. See illustration.
- To secure the touch screen, secure the lower portion with a device such as the LCD display panel. Do not attach the upper electrode with double-sided tape or similar product to avoid stress that can damage the upper or lower electrode.
- In order to balance upper and lower pressure, an air vent may be installed. Ensure that no liquid or oil will enter into the device.
- Moisture from condensation on tail connection or edges may result in migration, causing short circuit failure.
- Remove protective film from the touch screen after installation is completed.

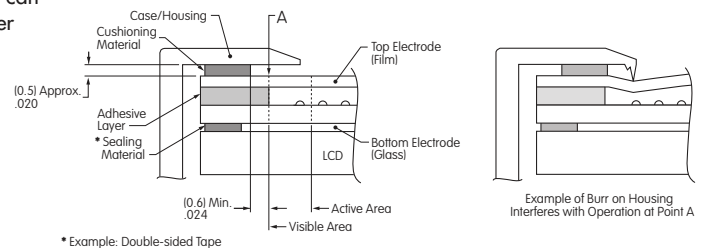

Handling Precautions

- When opening product, take precaution with up/down and front/back directions. Glass edges are not chamfered, and corners or edges can be sharp. Wear gloves when handling the product.
- Do not pick up the product by the tail or pull the tail area.
- Use gloves or finger cots to prevent fingerprints on surface.
- When handling the product, hold it outside of the viewing area.
- Avoid stacking multiple products or placing other items on the product.
- Clean with a soft cloth and ethanol. Do not use any cleaning agents other than ethanol.
- Store product in original package and store at the temperature and humidity range specified.
- Do not store in an environment with acids or other corrosive gases or where condensation may occur.

Operating Precautions

- Operate with fingers or a touch screen stylus only.
- Do not press hard with a pen or similar object between viewing area and key area.

Design Precautions

- With analog type, resistive value change (by aging or individual differences) can dislocate the input area. Input area can be calibrated with software.
- When installing on top of an LCD, noise from the display device can cause misoperation. To avoid noise, implement grounding the display device frame.
- Do not create software for simultaneous touch points, as analog type will read the center point between two touch points.
- When used to draw a line, analog type will have a break at dot spacer. Compensate for this with software.
- Contact resistance may cause chatter depending on pressing condition. Software should detect signal after it stabilizes.

Other Precautions

- Not suited for use in critical control systems without proper fail-safe design consideration.
- Products are guaranteed based on evaluation of standards within the moisture tolerance and usage temperature range, but not guaranteed to operate perpetually at this temperature.
- Calibration data from one touch panel should not be applied to another panel; each should be calibrated individually.
- Recalibration is necessary if connector has been removed from the tail and reconnected.
- All specifications based on the tested touch screens only. Evaluate the products after installation.

NKK Expands Offering of Touch Screen Solutions

Superior Endurance & Smooth Operation
Series TP02 4-Wire Analog

4:3 Narrow

10.4" 12.1" 15.0" 19.0"

16:9 Wide

10.6" 12.1" 15.6"



Motion Sensitive Performance
Series TP02 4-Wire Analog

4:3 Narrow

10.4" 12.1" 15.0" 19.0"

16:9 Wide

10.6" 12.1" 15.6"

Controller Board  IC Chip 

Controller boards and IC chips for multi-touch are available only with touch screens. Single touch controller boards are available separately.



Touch Screen Without IC Chip
Series FT Digital

5.7"

Exceptional Durability
Series FT 5-Wire or 8-Wire Analog

4:3 Narrow

10.4" 12.1" 15.0"

Controller Board  IC Chip 

Variety of Sizes
Series FT 4-Wire Analog with Printed Tail



4:3 Narrow

5.7" 6.5" 8.4" 10.4" 12.1"

15.0" 19.0"

16:9 Wide

10.6" 12.1" 15.6"

Controller Board  IC Chip 

Remarkable Contact Reliability
Series FT 4-Wire Analog with FPC Tail



4:3 Narrow

5.7" 6.5" 8.4" 10.4" 10.4"

12.1" 15.0" 19.0"

16:9 Wide

10.6" 12.1" 15.6"

Controller Board  IC Chip 

Effective Date September 2020



www.nkkswitches.com • 1.877.2BUYNKK (228.9655)
7850 East Gelding Drive • Scottsdale, AZ 85260 • Telephone 480.991.0942 • Fax 480.998.1435