

## P-Channel Enhancement Mode Power MOSFET

### Description

The GT6K2P10KH uses advanced trench technology to provide excellent  $R_{DS(ON)}$ , low gate charge. It can be used in a wide variety of applications.

### General Features

- $V_{DS}$  -100V
- $I_D$  (at  $V_{GS} = -10V$ ) -4.3A
- $R_{DS(ON)}$  (at  $V_{GS} = -10V$ ) < 670mΩ
- 100% Avalanche Tested
- RoHS Compliant

### Application

- Power switch
- DC/DC converters

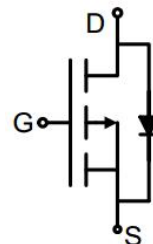

Schematic diagram

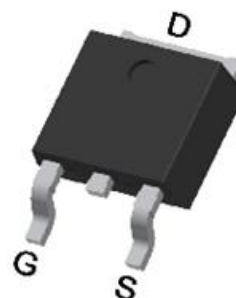

TO-252

### Ordering Information

Device	Package	Marking	Packaging
GT6K2P10KH	TO-252	GT6K2P10	2500pcs/Reel

### Absolute Maximum Ratings $T_C = 25^\circ\text{C}$ , unless otherwise noted

Parameter	Symbol	Value	Unit
Drain-Source Voltage	$V_{DS}$	-100	V
Continuous Drain Current	$I_D$	-4.3	A
Pulsed Drain Current (note1)	$I_{DM}$	-17.2	A
Gate-Source Voltage	$V_{GS}$	$\pm 20$	V
Power Dissipation	$P_D$	25	W
Operating Junction and Storage Temperature Range	$T_J, T_{stg}$	-55 To 150	$^\circ\text{C}$

### Thermal Resistance

Parameter	Symbol	Value	Unit
Thermal Resistance, Junction-to-Ambient	$R_{thJA}$	60	$^\circ\text{C/W}$
Maximum Junction-to-Case	$R_{thJC}$	4.96	$^\circ\text{C/W}$

Specifications $T_J = 25^\circ\text{C}$ , unless otherwise noted						
Parameter	Symbol	Test Conditions	Value			Unit
			Min.	Typ.	Max.	
<b>Static Parameters</b>						
Drain-Source Breakdown Voltage	$V_{(BR)DSS}$	$V_{GS} = 0V, I_D = -250\mu A$	-100	--	--	V
Zero Gate Voltage Drain Current	$I_{DSS}$	$V_{DS} = -100V, V_{GS} = 0V$	--	--	-1	$\mu A$
Gate-Source Leakage	$I_{GSS}$	$V_{GS} = \pm 20V$	--	--	$\pm 100$	nA
Gate-Source Threshold Voltage	$V_{GS(th)}$	$V_{DS} = V_{GS}, I_D = -250\mu A$	-1.0	-2.5	-3.0	V
Drain-Source On-Resistance	$R_{DS(on)}$	$V_{GS} = -10V, I_D = -1A$	--	525	670	m $\Omega$
Forward Transconductance	$g_{FS}$	$V_{DS} = -5V, I_D = -1A$	--	3	--	S
<b>Dynamic Parameters</b>						
Input Capacitance	$C_{iss}$	$V_{GS} = 0V,$ $V_{DS} = -50V,$ $f = 1.0\text{MHz}$	--	247	--	pF
Output Capacitance	$C_{oss}$		--	21	--	
Reverse Transfer Capacitance	$C_{rss}$		--	3	--	
Total Gate Charge	$Q_g$	$V_{DD} = -50V,$ $I_D = -1A,$ $V_{GS} = -10V$	--	10	--	nC
Gate-Source Charge	$Q_{gs}$		--	1	--	
Gate-Drain Charge	$Q_{gd}$		--	4	--	
Turn-on Delay Time	$t_{d(on)}$	$V_{DD} = -50V,$ $I_D = -1A,$ $R_G = 6\Omega$	--	4	--	ns
Turn-on Rise Time	$t_r$		--	5	--	
Turn-off Delay Time	$t_{d(off)}$		--	16	--	
Turn-off Fall Time	$t_f$		--	44	--	
<b>Drain-Source Body Diode Characteristics</b>						
Continuous Body Diode Current	$I_S$	$T_C = 25^\circ\text{C}$	--	--	-4.3	A
Body Diode Voltage	$V_{SD}$	$T_J = 25^\circ\text{C}, I_{SD} = -1A, V_{GS} = 0V$	--	--	-1.2	V
Reverse Recovery Charge	$Q_{rr}$	$I_F = -1A, V_{GS} = 0V$ $di/dt = -100A/\mu s$	--	157	--	nC
Reverse Recovery Time	$T_{rr}$		--	60	--	ns

### Notes

1. Repetitive Rating: Pulse width limited by maximum junction temperature
2. Identical low side and high side switch with identical  $R_G$

### Gate Charge Test Circuit

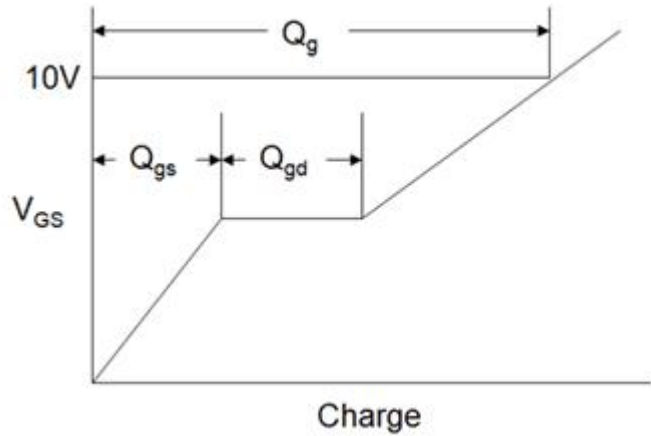

### Switch Time Test Circuit

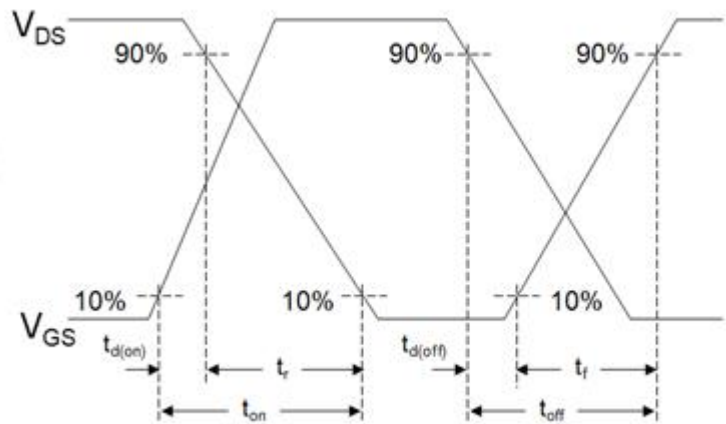
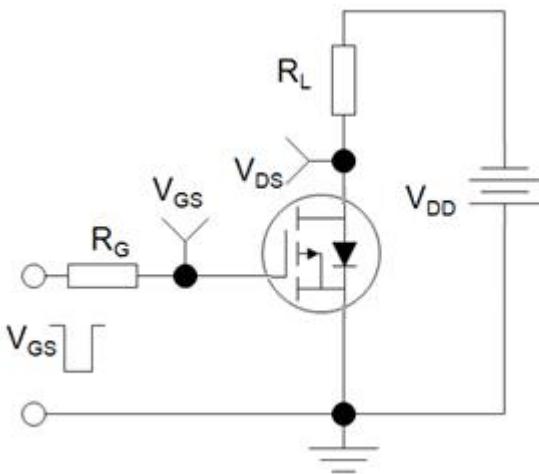

### EAS Test Circuit

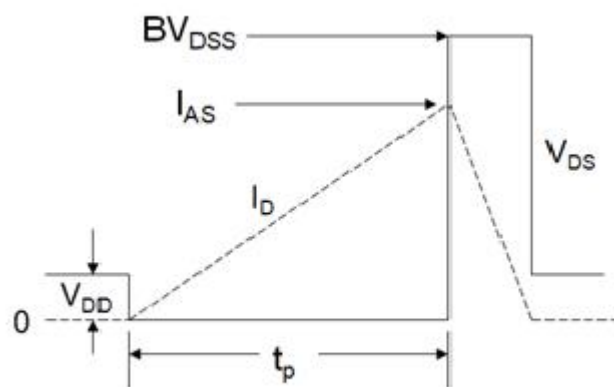

Typical Characteristics  $T_J = 25^\circ\text{C}$ , unless otherwise noted

Figure 1. Output Characteristics

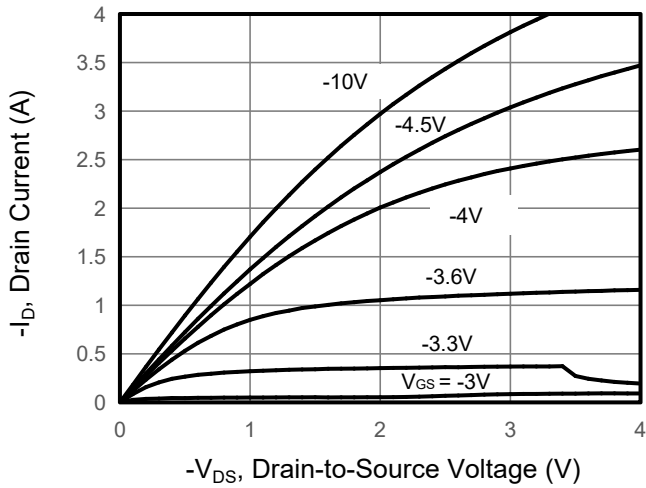

Figure 2. Transfer Characteristics

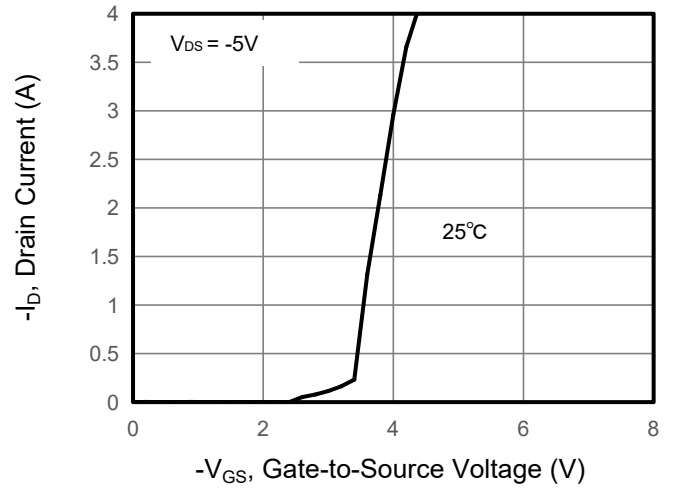

Figure 3. Drain Source On Resistance

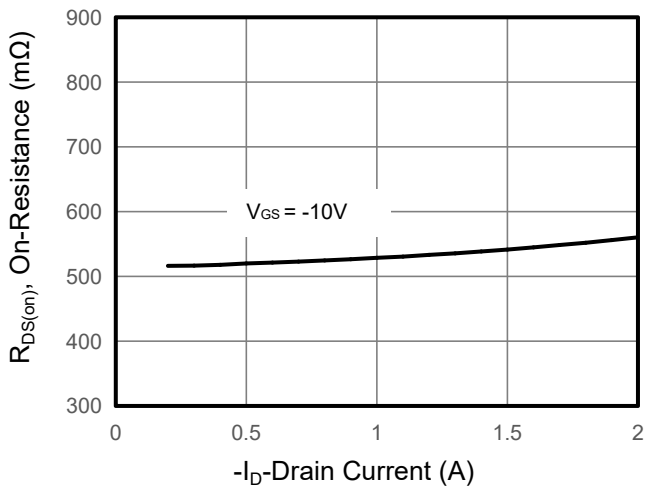

Figure 4. Gate Charge

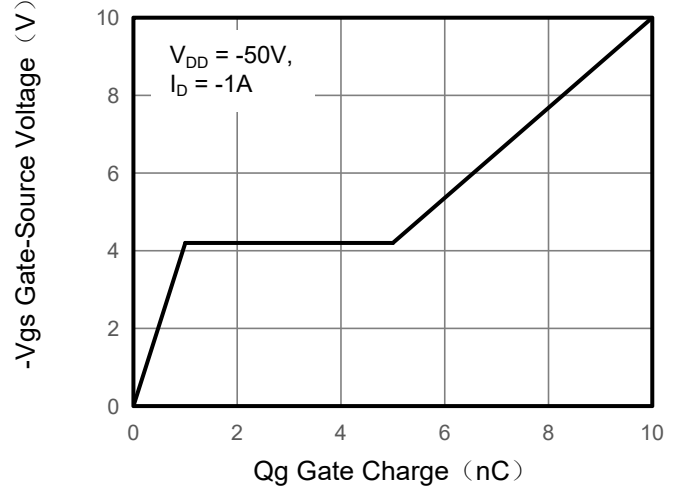

Figure 5. Capacitance

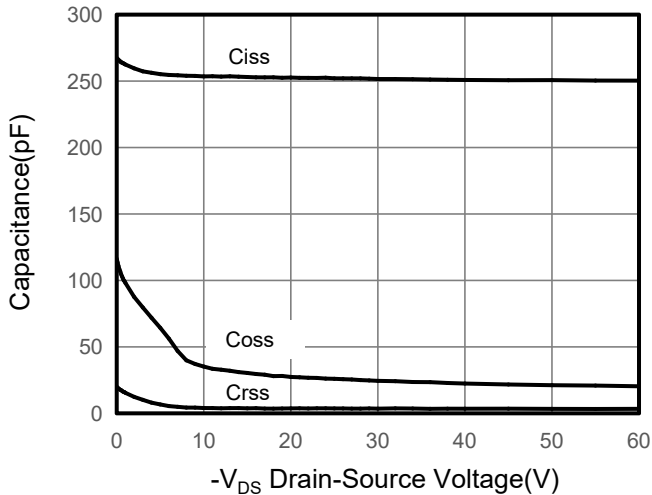
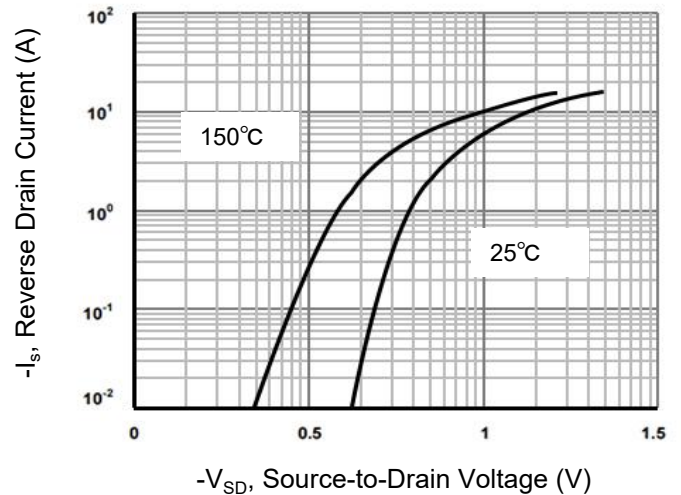

Figure 6. Source-Drain Diode Forward



Typical Characteristics  $T_J = 25^\circ\text{C}$ , unless otherwise noted

Figure 7. Drain-Source On-Resistance

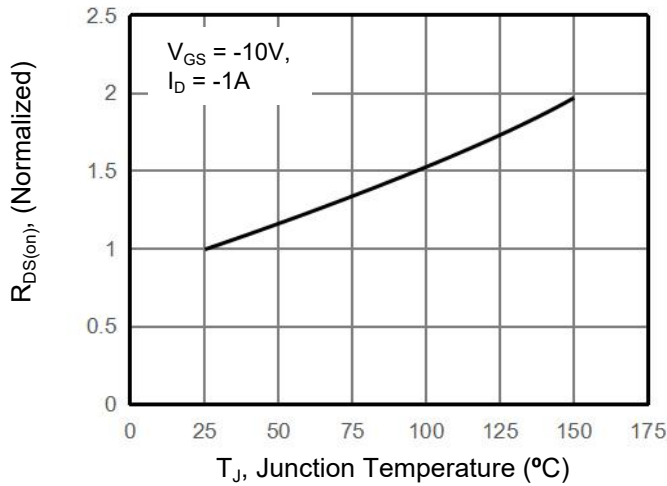

Figure 10. Safe Operation Area

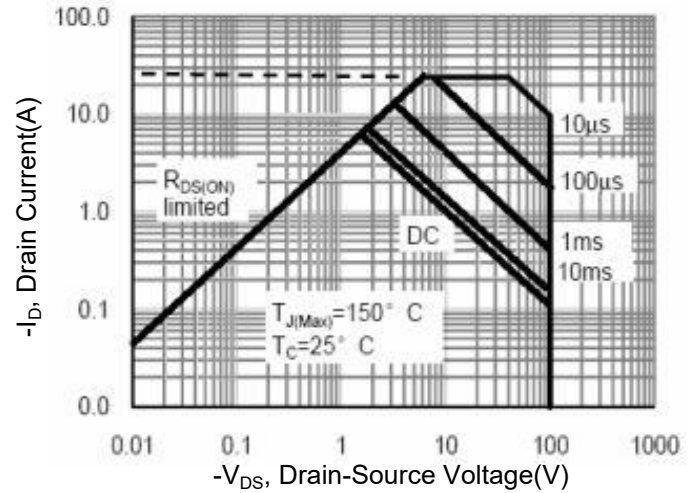
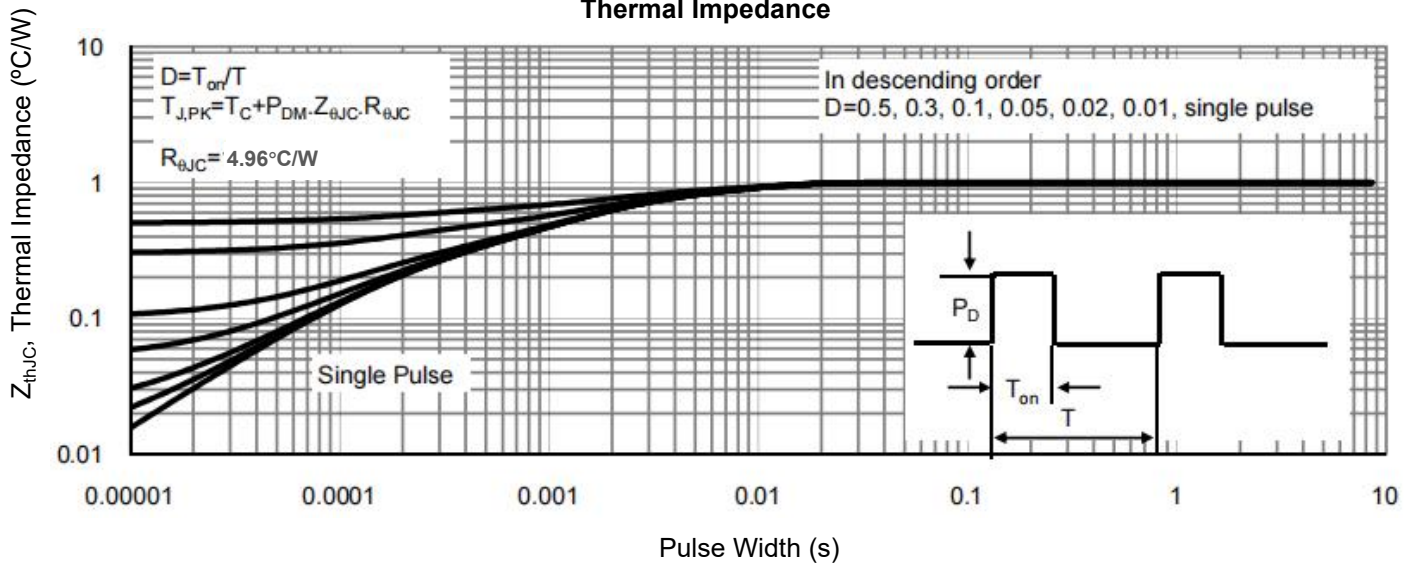
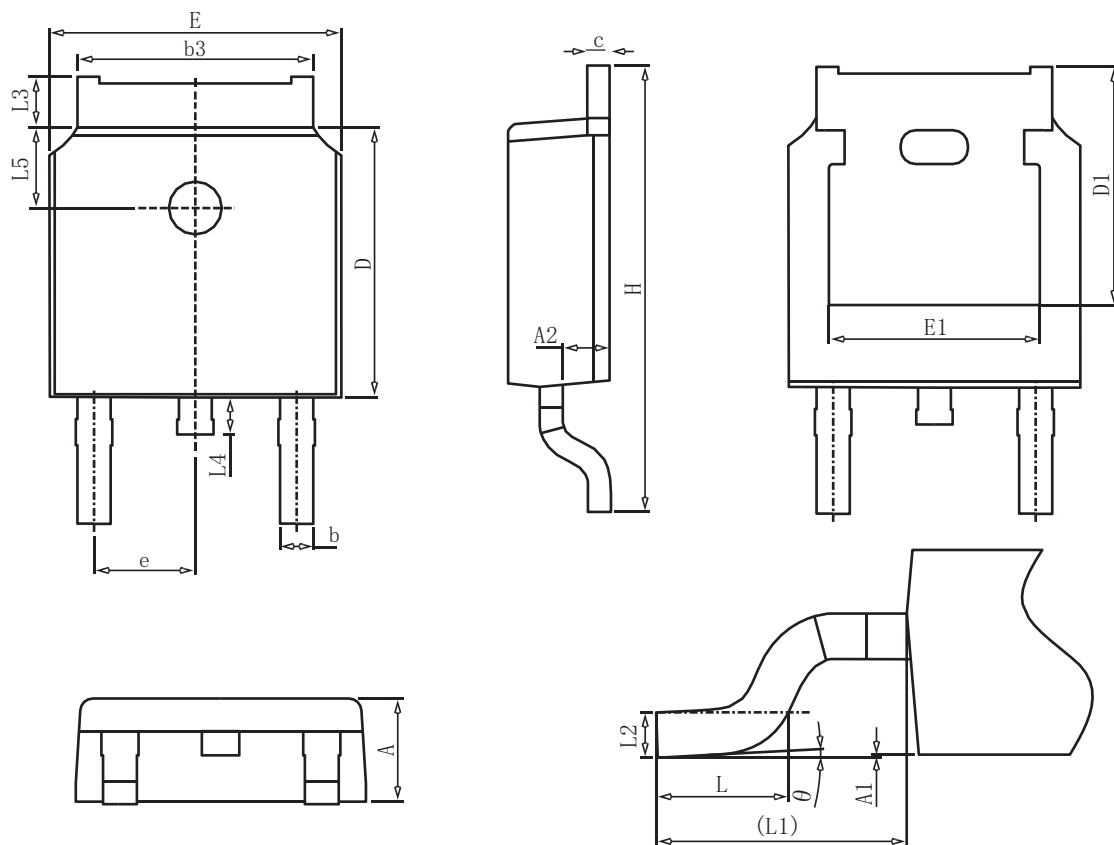

Figure 9. Normalized Maximum Transient Thermal Impedance



## TO-252 Package Information



### COMMON DIMENSIONS

SYMBOL	mm		
	MIN	NOM	MAX
A	2.20	2.30	2.40
A1	0.00	-	0.20
A2	0.97	1.07	1.17
b	0.68	0.78	0.90
b3	5.20	5.33	5.50
c	0.43	0.53	0.63
D	5.98	6.10	6.22
D1	5.30REF		
E	6.40	6.60	6.80
E1	4.63	-	-
e	2.286BSC		
H	9.40	10.10	10.50
L	1.38	1.50	1.75
L1	2.90REF		
L2	0.51BSC		
L3	0.88	-	1.28
L4	0.50	-	1.00
L5	1.65	1.80	1.95
θ	0°	-	8°