

MET-44 WG OVERHEAD DOOR CONTACTS

**MET-46 WG-WP18 (Water Resistant - SPDT)

4.22"Lx1.73"Wx.47"H Surface Mount Armored Commercial Type



Contact Size: 4.22"Lx1.73"Wx.47"H

(107.2mmx44mmx12mm)

Standard Magnet Size: 4.13"Lx2.42"Wx1.5"H

(105mmx61.7mmx38mm)

Standard Gap: 2"(50mm)

Colors: Aluminum Case

18"(458mm) Armored Leads

36"(915mm) Armored Leads Available

Specifications

Part Number	Gap Inch(mm)	Loop Open/Closed	Reed Form	Max. Contact Rating (W)	Max. Initial Contact Resistance (mΩ)	Max. Switching Voltage (V)	Max. Switching Current (A)
MET-44 WG	2"(50)	CLOSED	Normally Open	10	100	AC110/DC100	0.5
MET-45 WG	1.93"(49)	OPEN	Normally Closed	3	100	AC30/DC30	0.2
MET-46 WG	1.93"(49)	SPDT	SPDT	3	100	AC30/DC30	0.2
** MET-46 WG -WP18	1.93"(49)	SPDT	SPDT	3	100	AC30/DC30	0.2

OPERATING TEMPERATURE:-40°C to +60°C

Outline Dimensions

Unit: inch(mm)

MET-44 WG/MET-45 WG

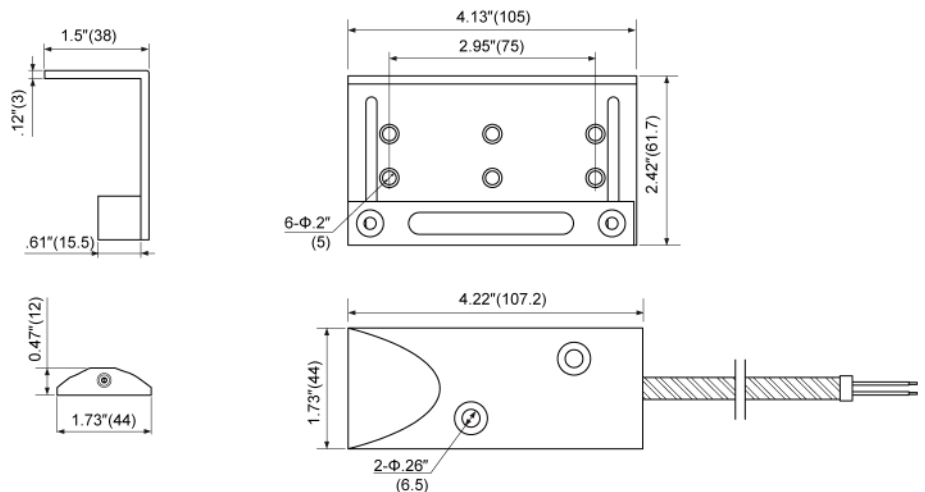

The Best Product Guarantee since 1984®

TANE ALARM PRODUCTS

906 JERICHO TURNPIKE, NEW HYDE PARK, NY 11040

Tel: 800-852-5050 • 516-328-3351 • Fax: 516-326-9125

www.tanealarm.com • E-MAIL: info@tanealarm.com

MET-44 WG OVERHEAD DOOR CONTACTS

Outline Dimensions

Unit: inch(mm)

MET-46 WG

MET-46WG-WP18

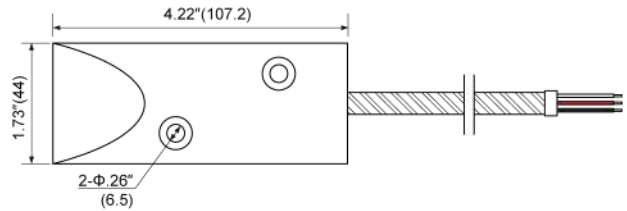
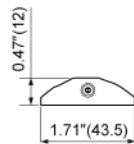
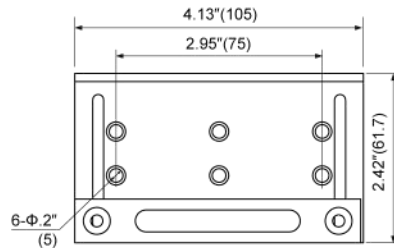
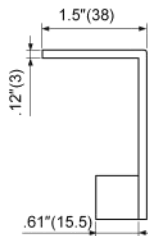
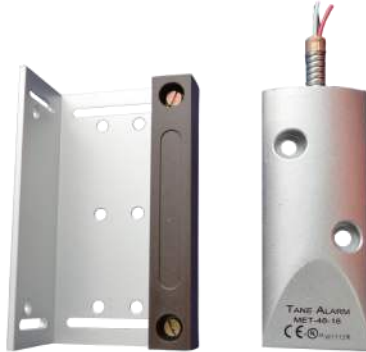

MET-46 WG & MET-46WG-WP18 Wiring Diagram

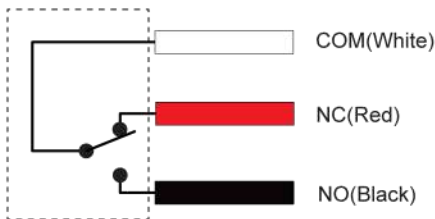

The Best Product Guarantee since 1984®

TANE ALARM PRODUCTS

906 JERICHO TURNPIKE, NEW HYDE PARK, NY 11040

Tel: 800-852-5050 • 516-328-3351 • Fax: 516-326-9125

www.tanealarm.com • E-MAIL: info@tanealarm.com

