

5mm Phototransistor PT333-3B

Features

- Fast response time
- High photo sensitivity
- Pb free
- The product itself will remain within RoHS compliant version.

Description

- PT333-3B is a high speed and high sensitive NPN silicon NPN epitaxial planar phototransistor molded in a standard 5 mm package. Due to its Black epoxy the device is sensitive to infrared radiation.

Applications

- Infrared applied system
- Camera
- Printer
- Cockroach catcher

Device Selection Guide

Chip Materials	Lens Color
Silicon	Black

Absolute Maximum Ratings (Ta=25°C)

Parameter	Symbol	Rating	Unit
Collector-Emitter Voltage	V_{CEO}	30	V
Emitter-Collector-Voltage	V_{ECO}	5	V
Collector Current	I_C	20	mA
Operating Temperature	T_{opr}	-40~+85	°C
Storage Temperature	T_{stg}	-40~ +100	°C
Lead Soldering Temperature	T_{sol}	260°C for 5sec	°C
Power Dissipation at (or below) 25°C Free Air Temperature	P_c	75	mW

Notes: *1:Soldering time \leq 5 seconds.

Electro-Optical Characteristics (Ta=25°C)

Parameter	Symbol	Min.	Typ.	Max.	Unit	Condition
Collector – Emitter Breakdown Voltage	BV_{CEO}	30	-----	-----	V	$I_C=100\mu A$ $E_e=0mW/cm^2$
Emitter-Collector Breakdown Voltage	BV_{ECO}	5	-----	-----	V	$I_E=100\mu A$ $E_e=0mW/cm^2$
Collector-Emitter Saturation Voltage	$V_{CE(sat)}$	-----	-----	0.4	V	$I_C=2mA$ $E_e=1mW/cm^2$
Rise Time	t_r	-----	15	-----	μS	$V_{CE}=5V$ $I_C=1mA$ $RL=1000\Omega$
Fall Time	t_f	-----	15	-----		
Collector Dark Current	I_{CEO}	-----	-----	100	nA	$E_e=0mW/cm^2$ $V_{CE}=20V$
On State Collector Current	$I_{C(on)}$	0.7	3.0	-----	mA	$E_e=1mW/cm^2$ $V_{CE}=5V$ $\lambda_p=940nm$
Rang Of Spectral Bandwidth	$\lambda_{0.5}$	840	-----	1100	nm	----
Wavelength of Peak Sensitivity	λ_P	-----	940	-----	nm	----

Rankings

Parameter	Symbol	Min	Max	Unit	Test Condition
G	$I_{C(ON)}$	0.70	1.90	mA	$V_{CE}=5V$ $E_e=1mW/cm^2$
H		1.14	2.60		
J		1.77	3.61		
K		2.67	5.07		
L		4.18	7.07		

Typical Electro-Optical Characteristics Curves

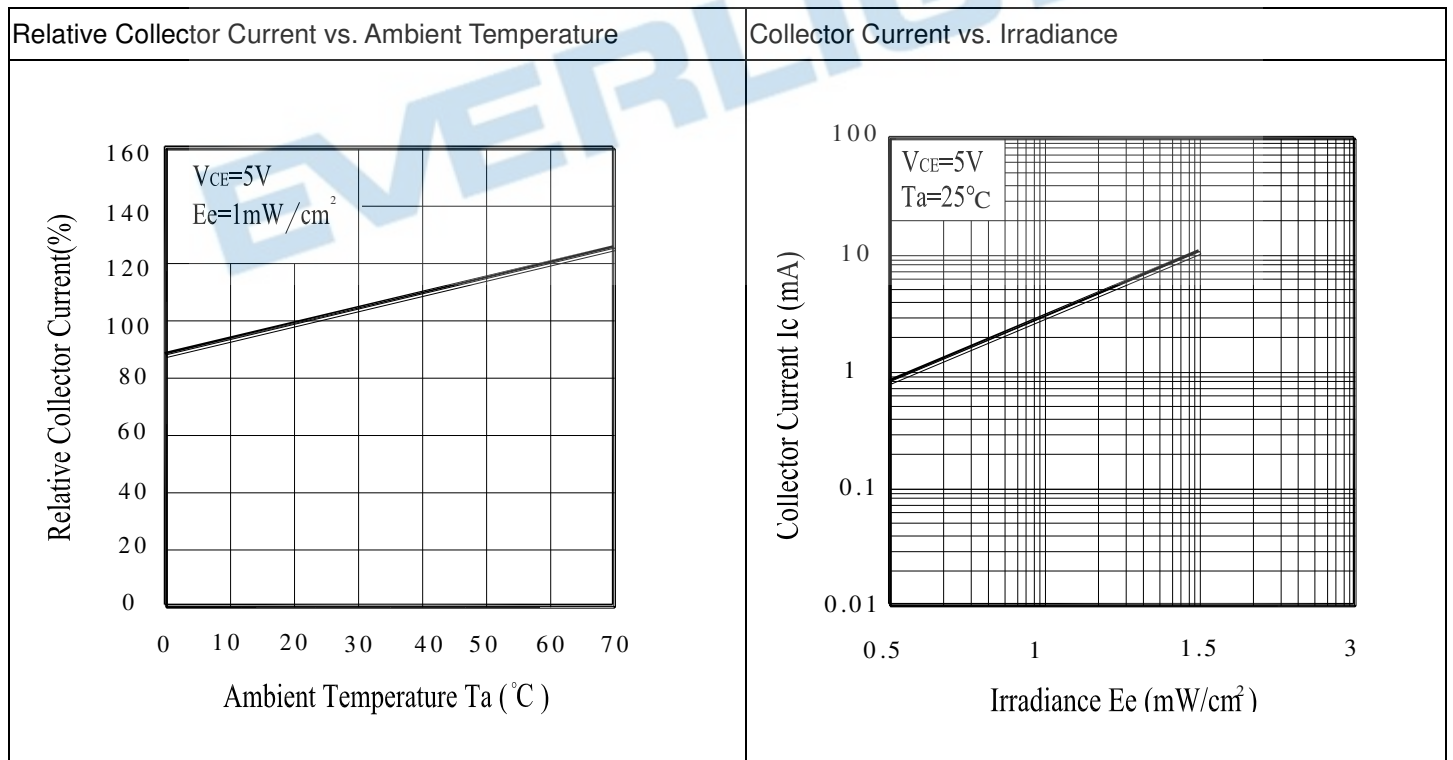
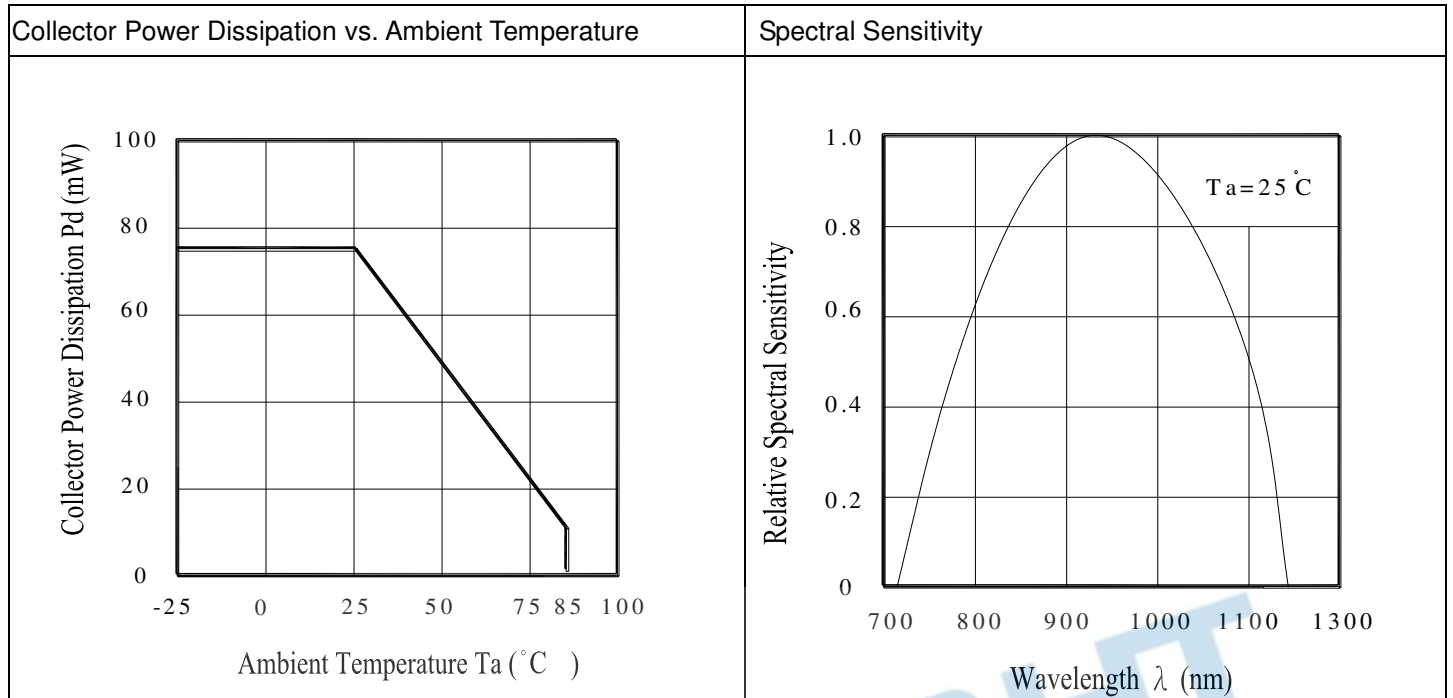

Collector Dark Current vs. Ambient Temperature

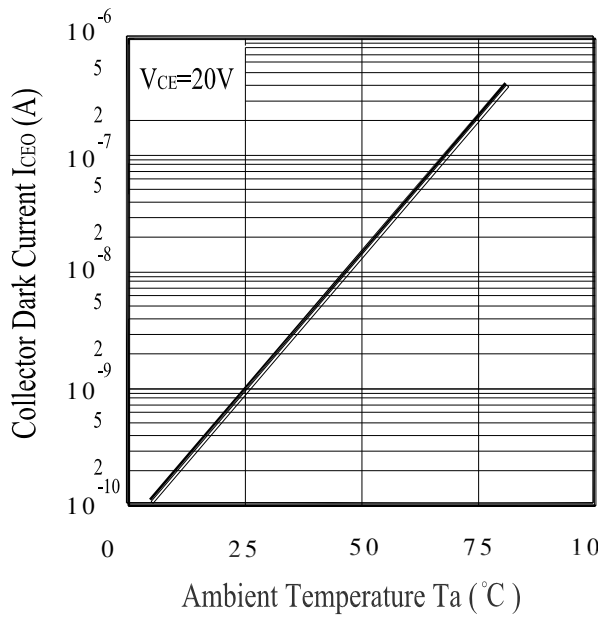

Collector Current vs. Collector-Emitter Voltage

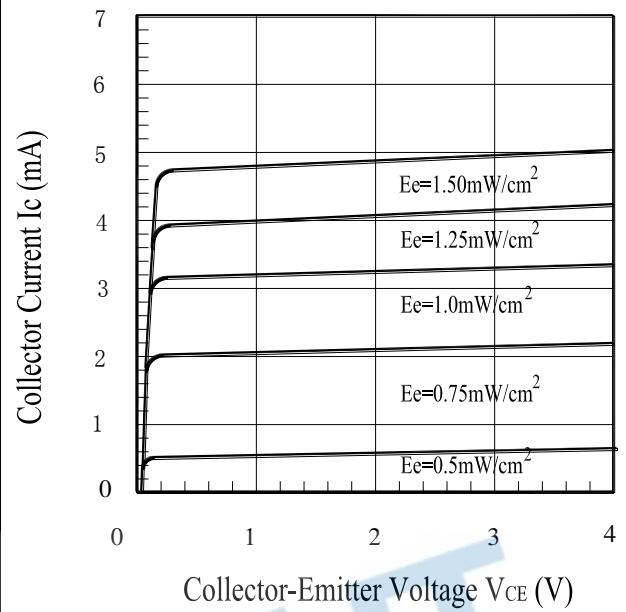

EVERLIGHT

Package Dimension

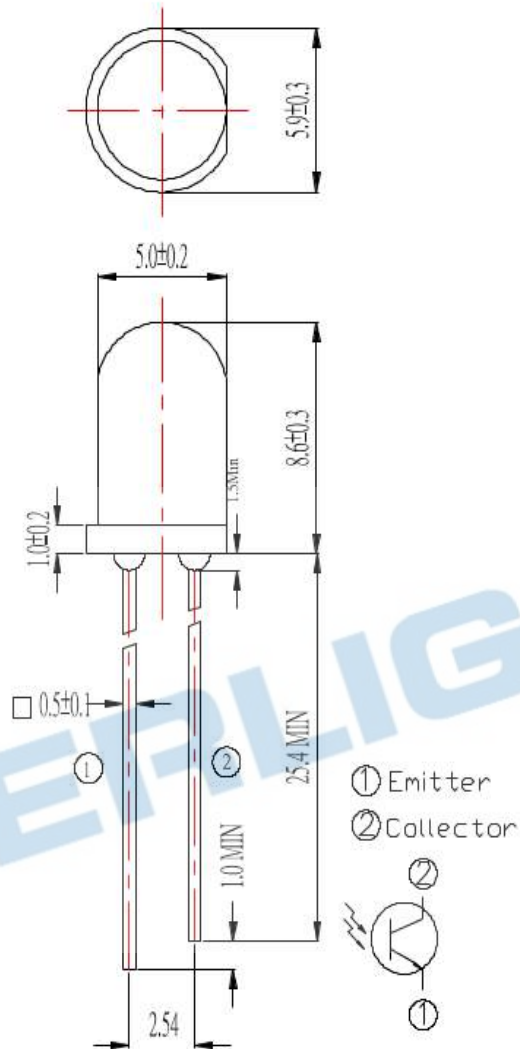

Note: Tolerances unless dimensions ± 0.25 mm

Label Explanation

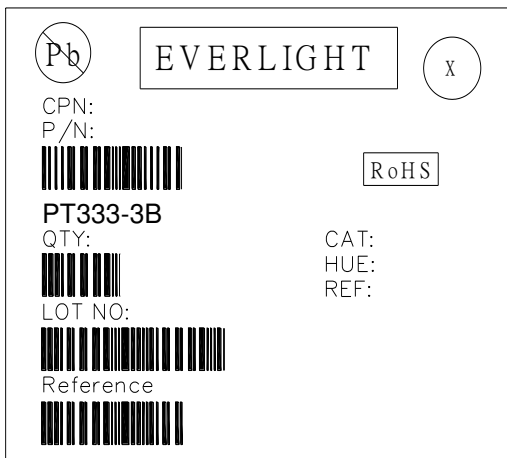

- CPN: Customer's Product Number
- P/N: Product Number
- QTY: Packing Quantity
- CAT: Luminous Intensity Rank
- HUE: Dom. Wavelength Rank
- REF: Forward Voltage Rank
- LOT No: Lot Number
- X: Month
- Reference: Identify Label Number

Packing Specification

■ Anti-electrostatic bag

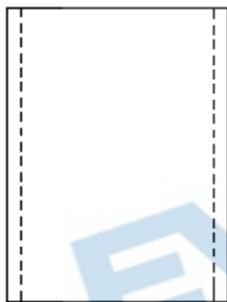

■ Inner Carton

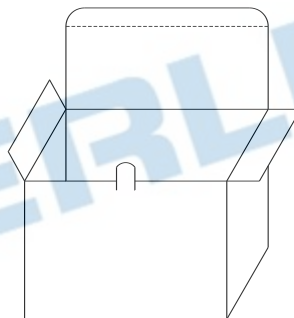

■ Outside Carton

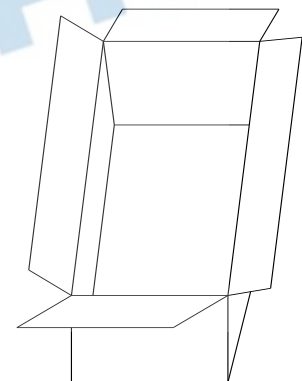

■ Packing Quantity

1. 500 PCS/1 Bag, 5 Bags/1 Inner Carton
2. 10 Inner Cartons/1 Outside Carton

Notes

1. Lead Forming

- During lead formation, the leads should be bent at a point at least 3mm from the base of the epoxy bulb.
- Lead forming should be done before soldering.
- Avoid stressing the PHOTOTRANSISTOR package during leads forming. The stress to the base may damage the PHOTOTRANSISTOR's characteristics or it may break the PHOTOTRANSISTOR s.
- Cut the PHOTOTRANSISTOR lead frames at room temperature. Cutting the lead frames at high temperatures may cause failure of the PHOTOTRANSISTOR s.
- When mounting the PHOTOTRANSISTOR s onto a PCB, the PCB holes must be aligned exactly with the lead position of the PHOTOTRANSISTOR . If the PHOTOTRANSISTOR s are mounted with stress at the leads, it causes deterioration of the epoxy resin and this will degrade the PHOTOTRANSISTOR s.

2. Storage

- The PHOTOTRANSISTOR s should be stored at 30°C or less and 70%RH or less after being shipped from Everlight and the storage life limits are 3 months. If the PHOTOTRANSISTOR s are stored for 3 months or more, they can be stored for a year in a seaPhototransistor container with a nitrogen atmosphere and moisture absorbent material. After opening the LEDs should be used up within 24 hours
- Please avoid rapid transitions in ambient temperature, especially, in high humidity environments where condensation can occur.

3. Soldering

- Careful attention should be paid during soldering. When soldering, leave more then 3mm from solder joint to epoxy bulb, and soldering beyond the base of the tie bar is recommended.
- Recommended soldering conditions:

Hand Soldering		DIP Soldering	
Temp. at tip of iron	300°C Max. (30W Max.)	Preheat temp.	100°C Max. (60 sec Max.)
Soldering time	3 sec Max.	Bath temp. & time	260 Max., 5 sec Max
Distance	3mm Min.(From solder joint to epoxy bulb)	Distance	3mm Min. (From solder joint to epoxy bulb)

- Recommended soldering profile

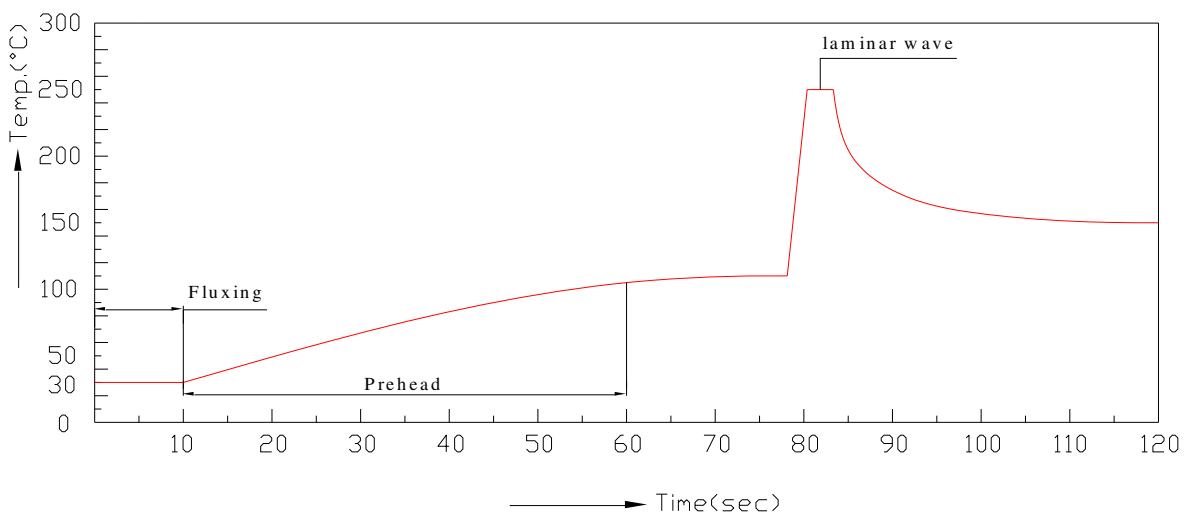

- Avoiding applying any stress to the lead frame while the PHOTOTRANSISTOR s are at high temperature particularly when soldering.
- Dip and hand soldering should not be done more than one time

- After soldering the PHOTOTRANSISTOR s, the epoxy bulb should be protected from mechanical shock or vibration until the PHOTOTRANSISTOR s return to room temperature.
 - A rapid-rate process is not recommended for cooling the PHOTOTRANSISTOR s down from the peak temperature. Although the recommended soldering conditions are specified in the above table, dip or hand soldering at the lowest possible temperature is desirable for the PHOTOTRANSISTOR s.
 - Wave soldering parameter must be set and maintain according to recommended temperature and dwell time in the solder wave.
4. Cleaning
- When necessary, cleaning should occur only with isopropyl alcohol at room temperature for a duration of no more than one minute. Dry at room temperature before use.
 - Do not clean the PHOTOTRANSISTOR s by the ultrasonic. When it is absolutely necessary, the influence of ultrasonic cleaning on the PHOTOTRANSISTOR s depends on factors such as ultrasonic power and the assembly condition. Ultrasonic cleaning shall be pre-qualified to ensure this will not cause damage to the PHOTOTRANSISTOR
5. Heat Management
- Heat management of PHOTOTRANSISTOR s must be taken into consideration during the design stage of PHOTOTRANSISTOR application. The current should be de-rated appropriately by referring to the de-rating curve found in each product specification.
 - The temperature surrounding the PHOTOTRANSISTOR in the application should be controlled. Please refer to the data sheet de-rating curve.
6. ESD (Electrostatic Discharge)
- Electrostatic discharge (ESD) or surge current (EOS) can damage PHOTOTRANSISTOR s.
 - An ESD wrist strap, ESD shoe strap or antistatic gloves must be worn whenever handling PHOTOTRANSISTOR s.
 - All devices, equipment and machinery must be properly grounded.
 - Use ion blower to neutralize the static charge which might have built up on surface of the PHOTOTRANSISTOR s plastic lens as a result of friction between PHOTOTRANSISTOR s during storage and handling.
7. Other
- Above specification may be changed without notice. EVERLIGHT will reserve authority on material change for above specification.
 - When using this product, please observe the absolute maximum ratings and the instructions for using outlined in these specification sheets. EVERLIGHT assumes no responsibility for any damage resulting from use of the product which does not comply with the absolute maximum ratings and the instructions included in these specification sheets.
 - These specification sheets include materials protected under copyright of EVERLIGHT corporation. Please don't reproduce or cause anyone to reproduce them without EVERLIGHT's consent.