

10 Gbps TRANSIMPEDANCE AMPLIFIER



Typical Applications

The HMC690 is ideal for:

- SONET OC-192 and SDH STM-64 Transponders
- 10 Gbps Ethernet
- Broadband instrumentation
- Short, intermediate and long reach optical receiver modules

Features

- Supports data rates up to 11.3 Gbps
- 1.25 Kohm differential gain
- +3.3 V single power supply
- AC or DC coupled outputs
- 11 pA/√Hz input referred noise density
- 3 mA p-p overload
- Average input power monitoring
- Output offset adjustment
- Die Size: 0.68 x 1.14 x 0.18mm

Functional Diagram

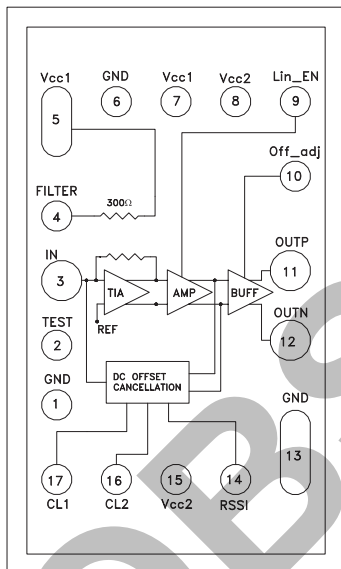

General Description

The HMC690 is 10 Gbps transimpedance amplifier designed for SONET OC-192 / SDH STM-64, 10GbE and 10Gbps systems employing optical amplifiers. It supports data rates up to 11.3 Gbps. This amplifier provides a differential output voltage that is proportional to an applied current at its input port. This current is typically provided by a photodiode. Operating from a single +3.3V supply, the HMC690 features low input referred noise, and is designed for driving a CDR or a typical transceiver directly. The RSSI output can be used for monitoring average input power. This device also features a DC offset control, which enables output signal level adjustment for asymmetrical signals. Additional features include an integrated 300Ω filter resistor for photo-diode supply voltage and an extended linear range^[2] option.

Electrical Specifications, $T_A = +25^\circ C$, $V_{cc1} = V_{cc2} = +3.3V$ ^[1]

Parameter	Conditions	Min.	Typ.	Max.	Units
AC Specifications					
Max Data Rate		11.3			Gbps
Small Signal Transimpedance (ZT)	Differential p-p @ 500 MHz	1.1	1.25	1.55	kOhm
Output Amplitude Differential peak-to-peak	For $I_{IN} > 1$ mA	430	500	560	mV
Small Signal Zt BW	3-dB Upper Llimit		7.5		GHz
Input Referred Noise Density	Noise Density @ 1 GHz		11.2	13.5	pA/√Hz
	Noise Density @ 5 GHz		13.4	14.7	pA/√Hz
Input Referred RMS Noise	@ 8 GHz Bandwidth		1.0		uA rms
Added p-p Deterministic Jitter				10	ps
Random Jitter	$I_{IN} > 1$ mA		300	500	fs rms
Rise Time	20 - 80%	17	21	25	ps

[1] Lin_en Open

[2] Please see Pin Description table for further explanation of the extended linear range option available on Pin 9.

10 Gbps TRANSIMPEDANCE AMPLIFIER

Electrical Specifications (Conditions)

Parameter	Conditions	Min.	Typ.	Max.	Units
Fall Time	80% - 20%	19	22	28	ps
Output Return Loss	F<10 GHz	10			dB
Zt Group Delay Variation			±20		ps
Linear Input Range			300		uA p-p
Input Overdrive			3		mA p-p
Optical Sensitivity [1]	@ 10 Gbps (P = 0.9A/W, re = 9 dB, BER = 1e-12)		-20		dBm
DC Specifications					
Power Supply		3.0	3.3	3.6	V
Supply Current		77	92	106	mA
OFF ADJ Sensitivity			780		mV/V
RSSI Sensitivity			-1		mA/V
Open Circuit Input DC Level		0.95		1.1	V

[1] Optical receiver sensitivity depends on packaging, photodiode type, BER value and input signal eye quality.

Photodiode Specification Assumptions

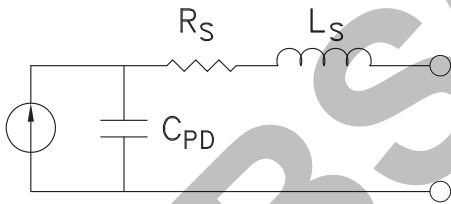

Photodiode Capacitance: (C_{pd}) = 220 fF

Photodiode and bond wire parasitic inductance: (L_s) = 800 pH

Photodiode Resistance: (R_s) = 20 Ohm

Photodiode Responsivity: (p) = 0.8 A/W

Differential Output Voltage vs. Input Current

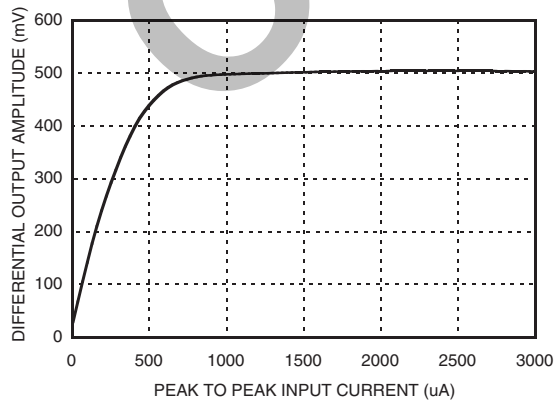

Differential Output Voltage vs. Temperature

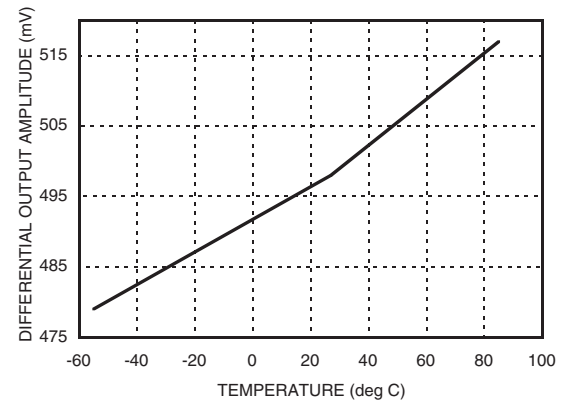

Information furnished by Analog Devices is believed to be accurate and reliable. However, no responsibility is assumed by Analog Devices for its use, nor for any infringements of patents or other rights of third parties that may result from its use. Specifications subject to change without notice. No license is granted by implication or otherwise under any patent or patent rights of Analog Devices. Trademarks and registered trademarks are the property of their respective owners.

For price, delivery, and to place orders: Analog Devices, Inc., One Technology Way, P.O. Box 9106, Norwood, MA 02062-9106
 Phone: 781-329-4700 • Order online at www.analog.com
 Application Support: Phone: 1-800-ANALOG-D



10 Gbps TRANSIMPEDANCE AMPLIFIER

RMS Jitter vs. Input Current [1]

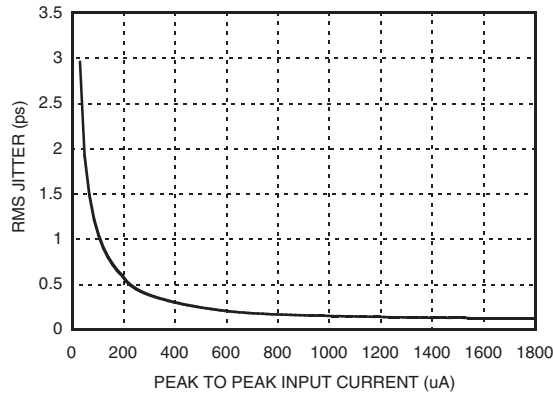

Peak to Peak Jitter vs. Peak to Peak Input Current [2]

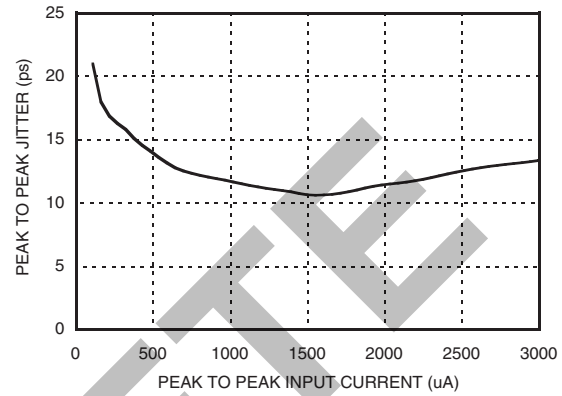

Rise Time vs. Peak to Peak Input Current

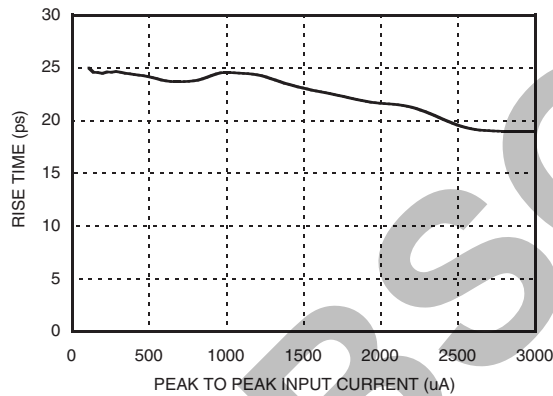

Fall Time vs. Peak to Peak Input Current

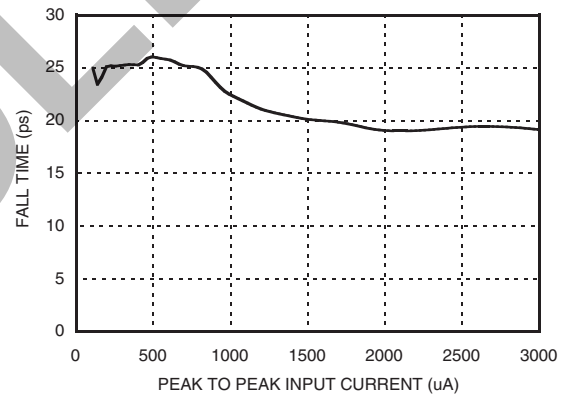

Transimpedance vs. Frequency Over Temperature [3]

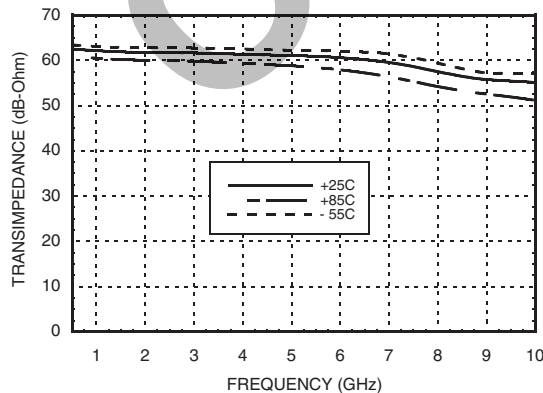

Output Return Loss vs. Frequency Over Temperature [3]

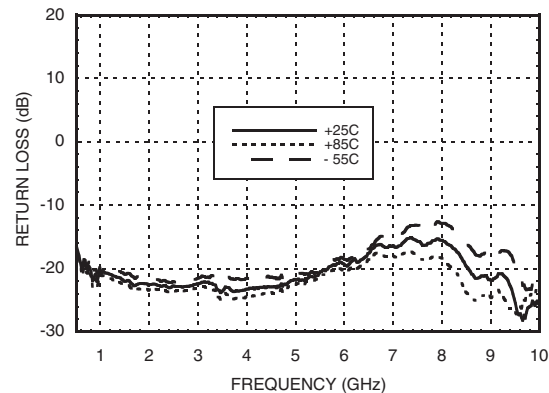

[1] Measured with 10 Gbps 10101 pattern with an estimated bondwire parasitic inductance of 1 nH, source jitter not de-embedded.
 [2] Measured with PRBS 2¹⁵-1 pattern at 10 Gbps with an estimated bondwire parasitic inductance of 1 nH. Source jitter not de-embedded.
 [3] Single-Ended OUTN

10 Gbps TRANSIMPEDANCE AMPLIFIER

RSSI Output Voltage vs. Input Current Over Temperature

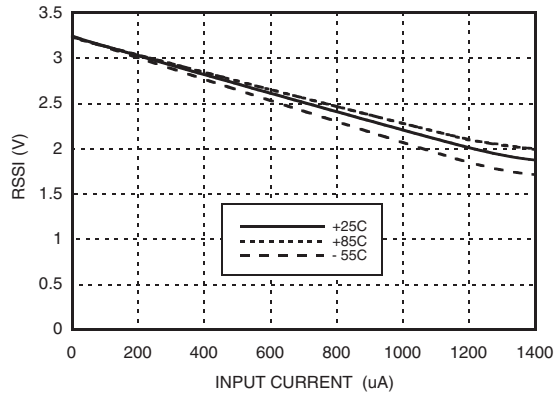

Output Offset Voltage vs. DC Offset Control Voltage Over Temperature

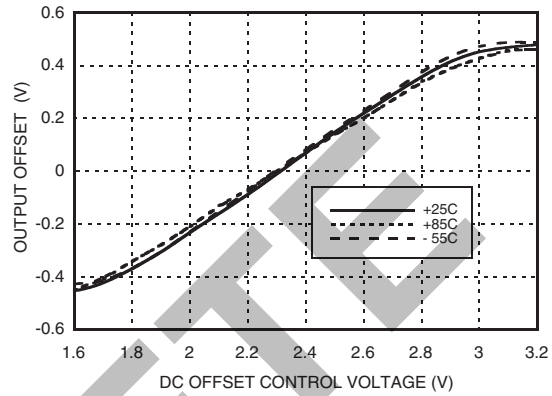

Eye Diagram [4]

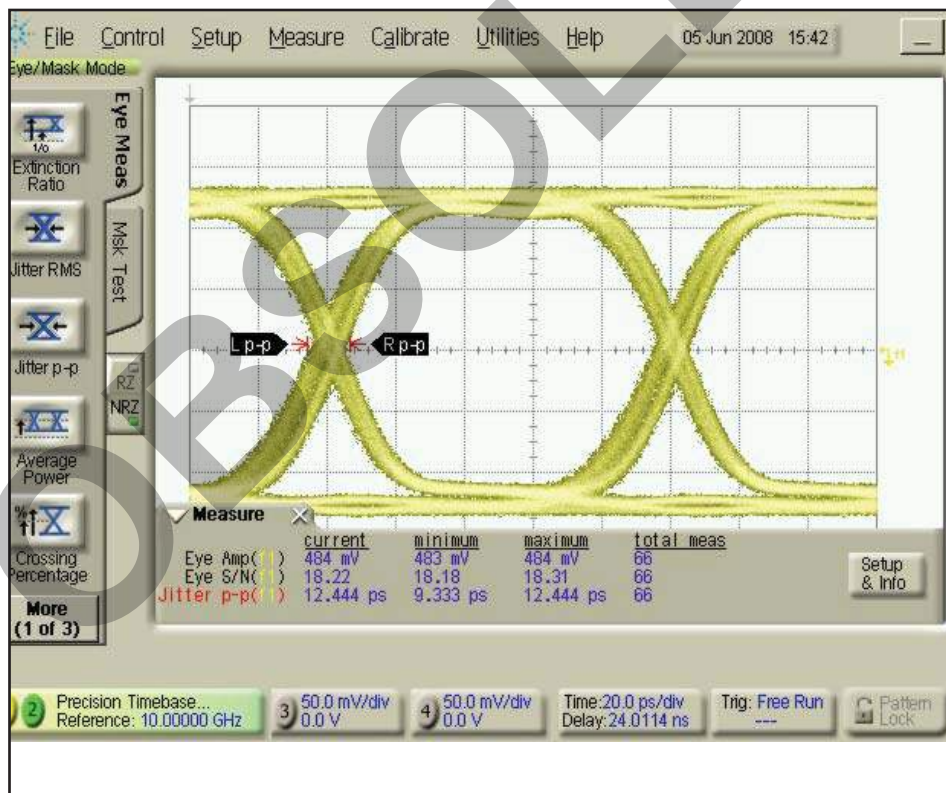

[1] Measured with 10 Gbps 10101 pattern with an estimated bondwire parasitic inductance of 1 nH, source jitter not de-embedded.
 [2] Measured with PRBS 2¹⁵-1 pattern at 10 Gbps with an estimated bondwire parasitic inductance of 1 nH. Source jitter not de-embedded.
 [3] Single-Ended OUTN
 [4] Output Eye measured on Eval board with 1 mA p-p input current. (10 Gbps), 25C, 3.3V, 2²³-1 pattern



10 Gbps TRANSIMPEDANCE AMPLIFIER

Supply Current vs. Supply Voltage Over Temperature

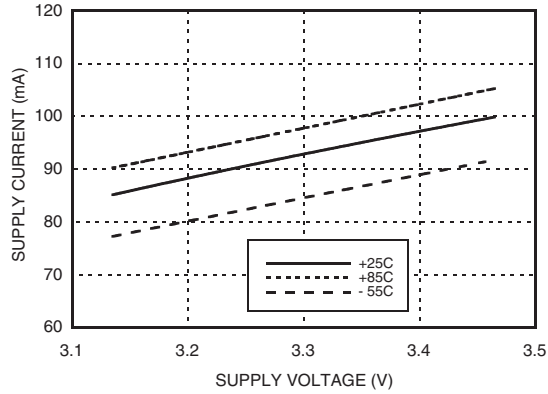

Optical Sensitivity Calculation

Optical sensitivity is determined from the input-referred rms noise current, I_N . To achieve a bit error rate of $1E^{-12}$, the signal-to-noise ratio must be 14:1.

$$S = 10 \log \left(\frac{SNR}{2} \times \frac{I_N}{r_e} \times \frac{r_e + 1}{r_e - 1} \times 1000 \right) \text{ dBm}$$

Where

- S = sensitivity (dBm)
- SNR = signal to noise ratio (dB)
- I_N = input-referred rms noise current (A)
- r_e = photodetector responsivity (A/W)
- r_e = extinction ratio (dB)

Optical Minimum Output Swing at Sensitivity Limit Calculation

The typical optical sensitivity is -19 dBm. At the input level, the voltage swing at output of the HMC690 is calculated as follows:

$$S_{ave} = 10 \log \left(\frac{OMA}{2} \times \frac{r_e + 1}{r_e - 1} \right)$$

Where

- S_{ave} = average sensitivity (dBm)
- OMA = optical modulation amplitude (Wp-p)
- r_e = extinction ratio (dB)

Information furnished by Analog Devices is believed to be accurate and reliable. However, no responsibility is assumed by Analog Devices for its use, nor for any infringements of patents or other rights of third parties that may result from its use. Specifications subject to change without notice. No license is granted by implication or otherwise under any patent or patent rights of Analog Devices. Trademarks and registered trademarks are the property of their respective owners.

For price, delivery, and to place orders: Analog Devices, Inc., One Technology Way, P.O. Box 9106, Norwood, MA 02062-9106 Phone: 781-329-4700 • Order online at www.analog.com Application Support: Phone: 1-800-ANALOG-D

10 Gbps TRANSIMPEDANCE AMPLIFIER

Absolute Maximum Ratings

Supply Voltage	4V
Off_adj Voltage	4V
Lin_EN Voltage	4V
Continuous Input Current	8 mA
Junction Temperature	125 °C
Continuous Pdiss (T=85 °C) (derate 9 mW/ °C Above +85 °C)	0.36 W
Thermal Resistance (Junction to die bottom)	111 °C/W
Storage Temperature	-65 to 120 °C
Operating Temperature	-40 to +85 °C

Outline

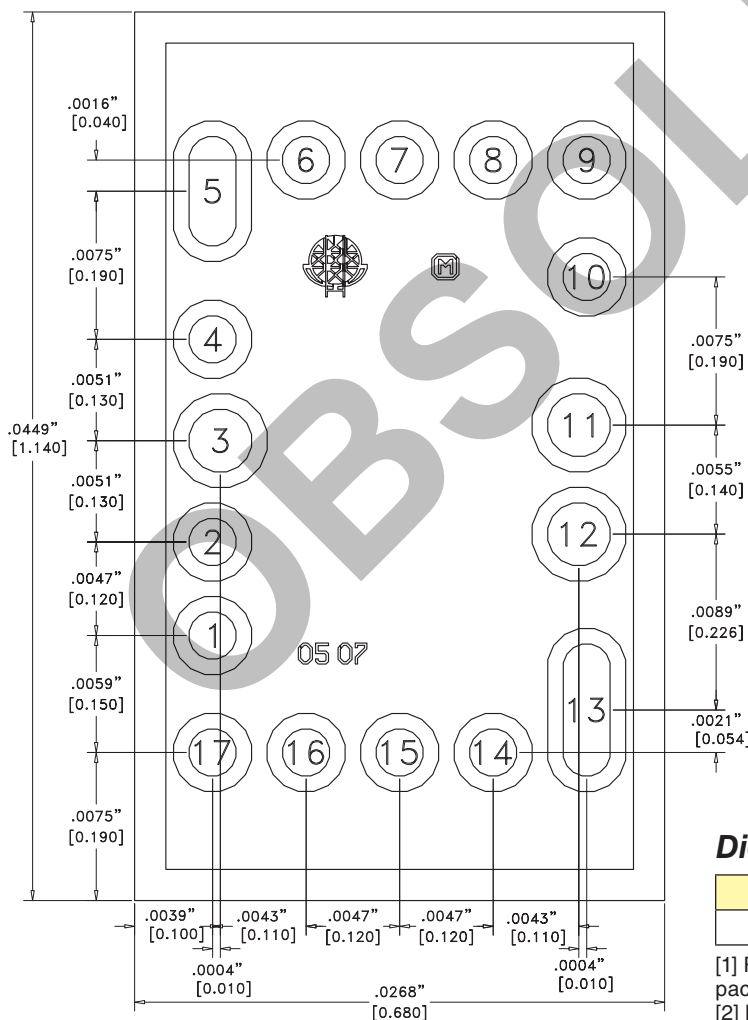

Die Packaging Information ^[1]

Standard	Alternate
WP-26 (Waffle Pack)	[2]

[1] Refer to the "Packaging Information" section for die packaging dimensions.

[2] For alternate packaging information contact Hittite Microwave Corporation.

Information furnished by Analog Devices is believed to be accurate and reliable. However, no responsibility is assumed by Analog Devices for its use, nor for any infringements of patents or other rights of third parties that may result from its use. Specifications subject to change without notice. No license is granted by implication or otherwise under any patent or patent rights of Analog Devices. Trademarks and registered trademarks are the property of their respective owners.

For price, delivery, and to place orders: Analog Devices, Inc., One Technology Way, P.O. Box 9106, Norwood, MA 02062-9106 Phone: 781-329-4700 • Order online at www.analog.com Application Support: Phone: 1-800-ANALOG-D



10 Gbps TRANSIMPEDANCE AMPLIFIER

Pad Descriptions

Pad Number	Function	Description	Interface Schematic
1, 6, 13	GND	Ground connection for TIA.	
2	TEST	Test Input. This pad is connected internally to IN thru 1kΩ. No external connection required.	
3	IN	TIA Input.	
4	FILTER	Provides bias voltage for photo diode (PD) thru a 300Ω resistor for Vcc1.	
5, 7	Vcc1	Power Supply for input stage and PD.	
8, 15	Vcc2	Power supply for output buffers.	
9	Lin_EN	HMC690 has an extended linear range feature. With this feature disabled (pin 9 floating), the HMC690 operates linearly for inputs less than 300 μAp-p. For input currents greater than 300 μAp-p, the HMC690 begins to operate within a saturated region. For input currents greater than 1 mA-p-p, the output is fully saturated. Enabling (pin 9 connected to 3.3V) this feature increases linear range of the device up to 350 μA increasing nominal supply current from 92 mA to 98 mA	
10	Off_adj	DC offset control. Voltage at this pad sets output DC offset. When it is floating DC offset is at 0V.	
11	OUTP	Non-inverted data output with 50Ω back termination.	
12	OUTN	Inverted data output with 50Ω back termination.	
14	RSSI	Received signal strength indicator. This pin provides a voltage proportional to the DC input current. This voltage should be monitored during assembly to optimally align the PD in the optical environment.	

Information furnished by Analog Devices is believed to be accurate and reliable. However, no responsibility is assumed by Analog Devices for its use, nor for any infringements of patents or other rights of third parties that may result from its use. Specifications subject to change without notice. No license is granted by implication or otherwise under any patent or patent rights of Analog Devices. Trademarks and registered trademarks are the property of their respective owners.

For price, delivery, and to place orders: Analog Devices, Inc., One Technology Way, P.O. Box 9106, Norwood, MA 02062-9106 Phone: 781-329-4700 • Order online at www.analog.com Application Support: Phone: 1-800-ANALOG-D

**10 Gbps TRANSIMPEDANCE
AMPLIFIER**

Pad Descriptions (Continued)

Pad Number	Function	Description	Interface Schematic
16	CL2	Connect a capacitor to ground to increase the on-chip DC-cancellation loop time constant. 0.1 μ F is recommended.	
17	CL1		

Application Circuit

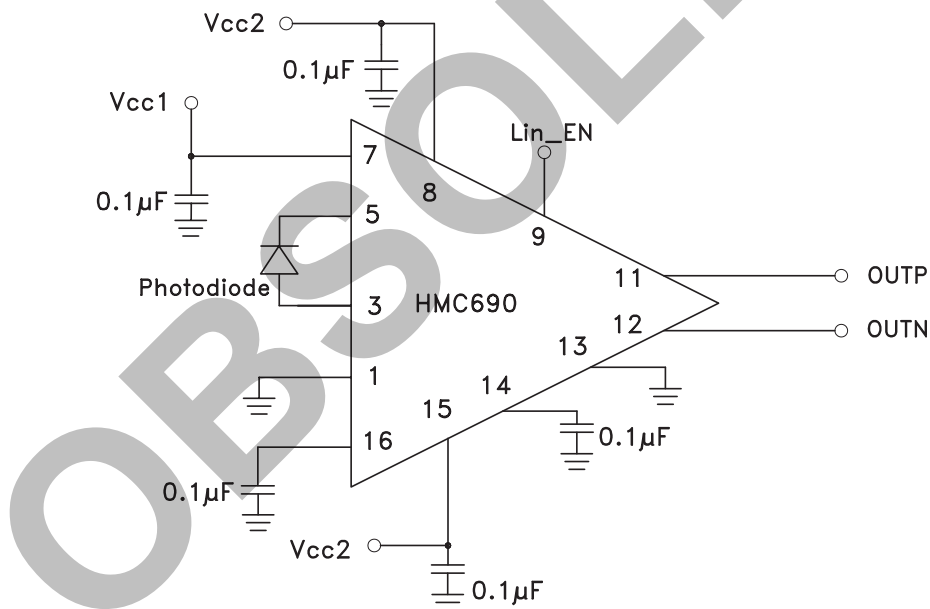



10 Gbps TRANSIMPEDANCE AMPLIFIER

Assembly Diagram

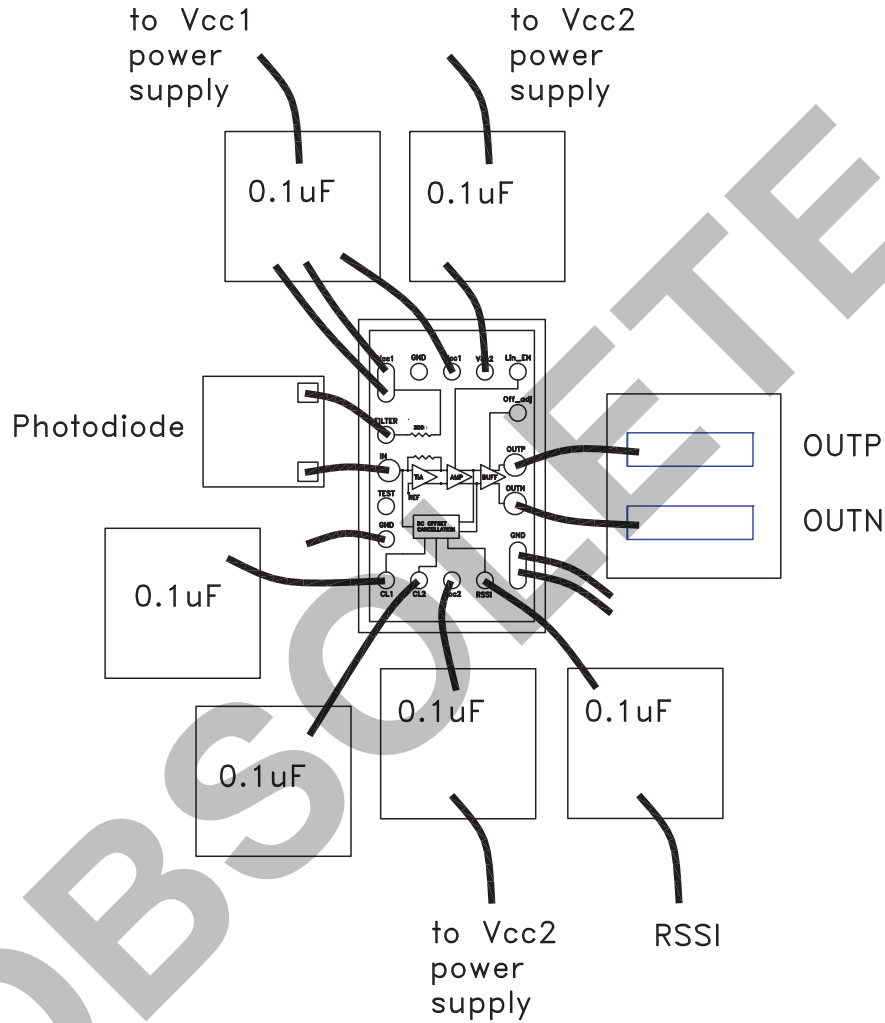

10 Gbps TRANSIMPEDANCE AMPLIFIER

Mounting & Bonding Techniques for Millimeterwave MMICs

The die should be attached directly to the ground plane with epoxy (see HMC general Handling, Mounting, Bonding Note).

50 Ohm Microstrip transmission lines on 0.25mm (10 mil) thick alumina thin film substrates are recommended for bringing RF to and from the chip (Figure 1).

Microstrip substrates should be placed as close to the die as possible in order to minimize bond wire length. Typical die-to-substrate spacing is 0.076mm to 0.152 mm (3 to 6 mils).

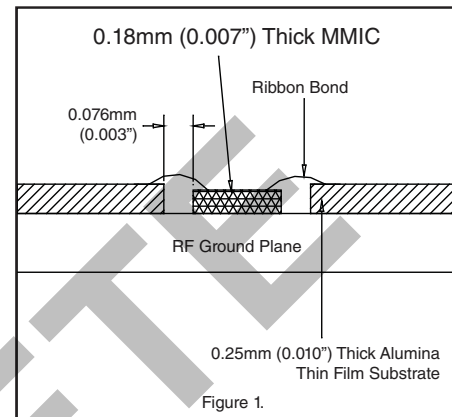

Handling Precautions

Follow these precautions to avoid permanent damage.

Storage: All bare die are placed in either Waffle or Gel based ESD protective containers, and then sealed in an ESD protective bag for shipment. Once the sealed ESD protective bag has been opened, all die should be stored in a dry nitrogen environment.

Cleanliness: Handle the chips in a clean environment. DO NOT attempt to clean the chip using liquid cleaning systems.

Static Sensitivity: Follow ESD precautions to protect against ESD strikes.

Transients: Suppress instrument and bias supply transients while bias is applied. Use shielded signal and bias cables to minimize inductive pick-up.

General Handling: Handle the chip along the edges with a vacuum collet or with a sharp pair of bent tweezers.

Mounting

The chip is not back-metallized and should be die mounted with epoxy. The mounting surface should be clean and flat.

Epoxy Die Attach: Apply a minimum amount of epoxy to the mounting surface so that a thin epoxy fillet is observed around the perimeter of the chip once it is placed into position. Cure epoxy per the manufacturer's schedule.

Wire Bonding

RF bonds made with two 1 mil wires are recommended. These bonds should be thermosonically bonded with a force of 40-60 grams. DC bonds of 0.001" (0.025 mm) diameter, thermosonically bonded, are recommended. Ball bonds should be made with a force of 40-50 grams and wedge bonds at 18-22 grams. All bonds should be made with a nominal stage temperature of 150 °C. A minimum amount of ultrasonic energy should be applied to achieve reliable bonds. All bonds should be as short as possible, less than 12 mils (0.31 mm).