

■ ELECTRICAL SPECIFICATION



GPS ANTENNA

Parameters	Value	Unit
Frequency Range	1575.420 ±3	MHz
Band Width	CF ±4	MHz
Polarization	RHCP	-
Gain (Zenith)	0	dBic
VSWR, max	1.5	-
Impedance	50	Ω

LNA

Parameters	Value	Unit
Gain, typ	20 ±2	dB
Noise Figure, max	1.5	dB
VSWR, max	2.0	-
Supply Voltage	3	VDC
Current Consumption, max	10	mA

GSM ANTENNA

Parameters	Value	Unit
Frequency Range	824 ~ 960 1710 ~ 2170	MHz
Polarization	Linear	-
Gain (Zenith)	2	dBi
VSWR, max	2.5	-
Impedance	50	Ω

■ MECHANICAL SPECIFICATION

Parameters	Value	Unit
Connector	IPEX	-
Cable	RG178	-
Radome Material	ABS	-
Mounting Method	Screw	-
Operating Temperature Range	-40 ~ +85	°C
Relative Humidity, max	95	%
Ingress Protection	@ Exclude Cable Outlet IP65 ~ IP67	-
Vibration	@ 1.5 mm amplitude 2hours 10 ~ 55	Hz
ROHS Compliant	YES	-

■ DIMENSIONS

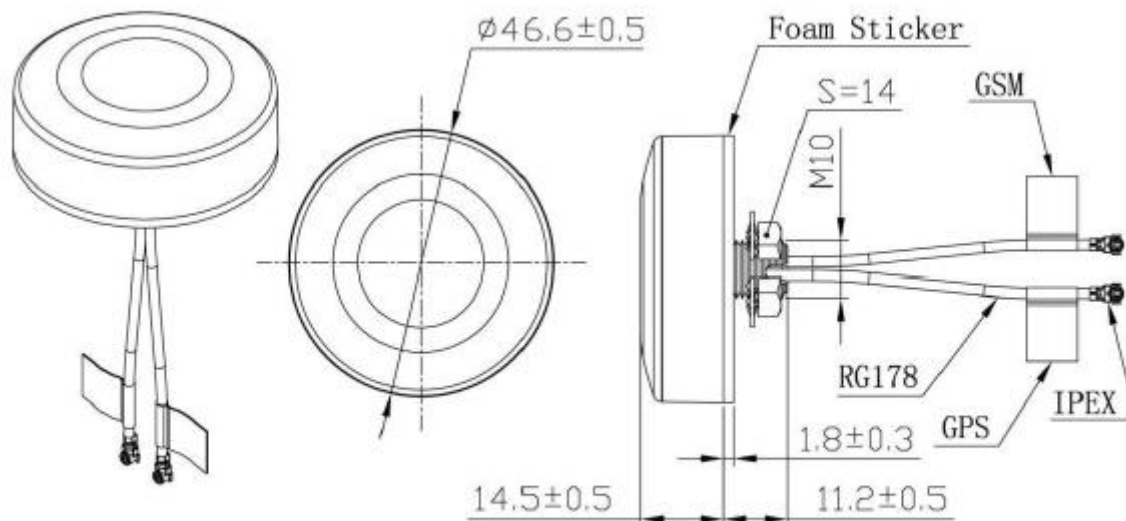

Unit: mm

■ RADIATION PATTERN

GPS ANTENNA

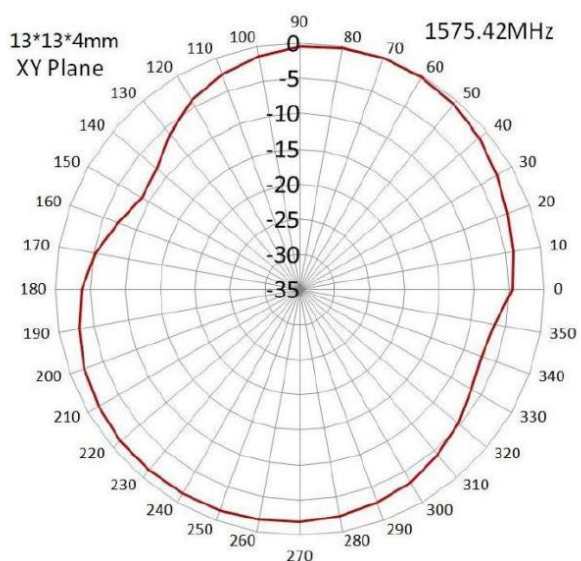

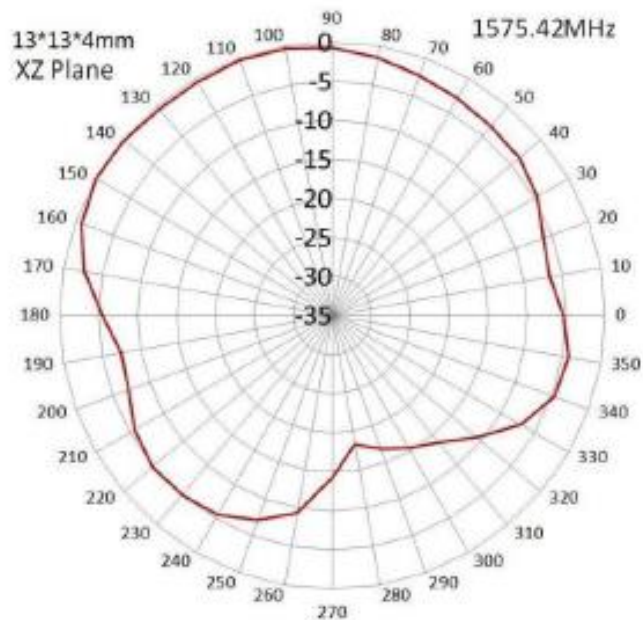
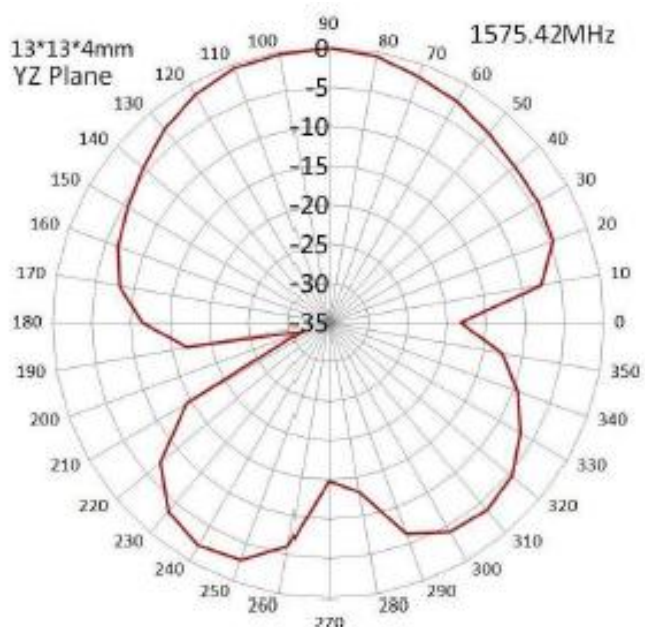

GSM ANTENNA

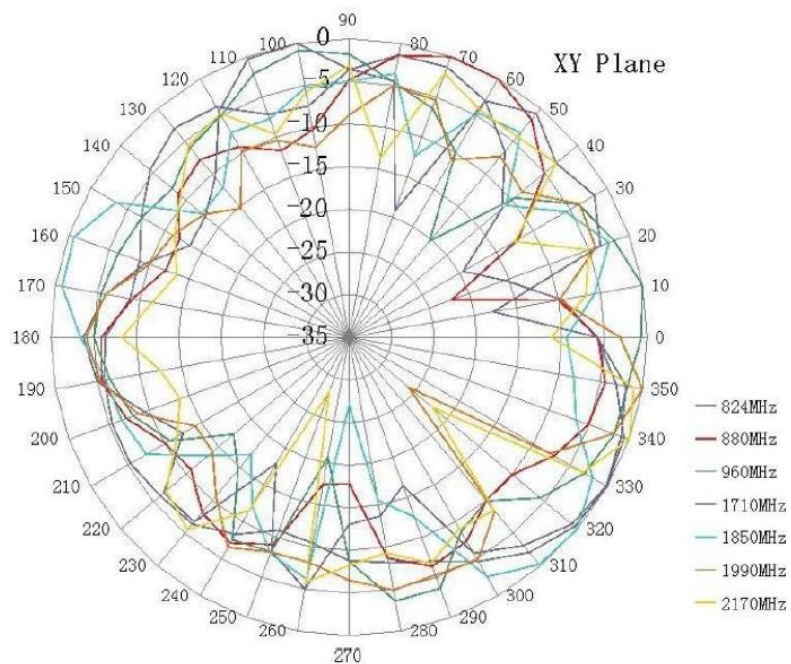

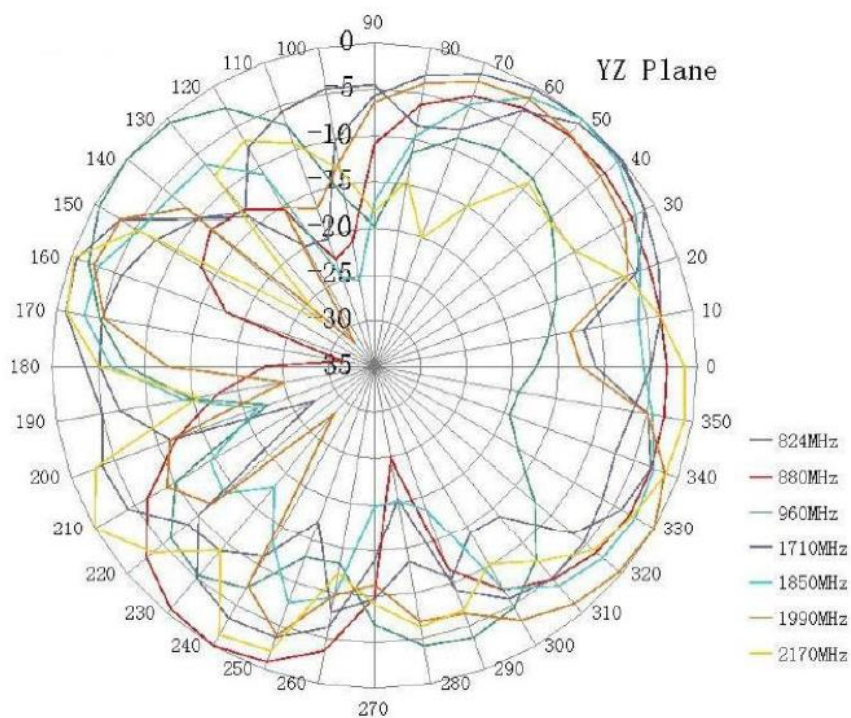
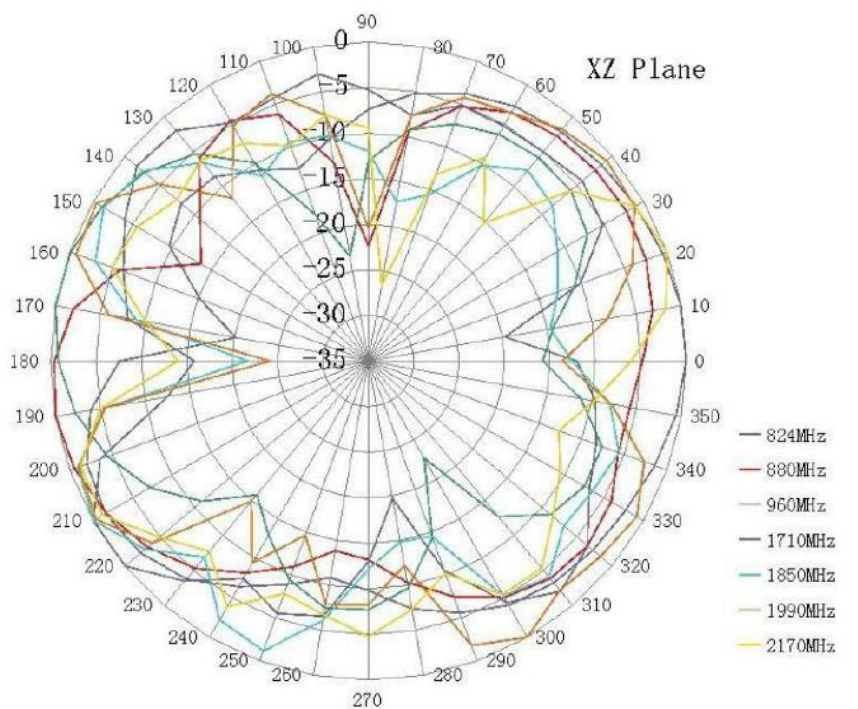

■ ENVIRONMENTAL

PARAMETER	VALUE
RoHS	Compliant
REACH SVHC	Compliant
HALOGEN-FREE	Compliant



■ APPROVAL

RALTRON	
DRAWN BY:	AR, July 12, 2022
APPROVED BY:	CP, July 12, 2022
REVISION:	A, Initial Release

Raltron Electronics / RAMI Technology USA, LLC, including its affiliates, employees, agents and other persons acting on its behalf (collectively Raltron/RAMI Tech), disclaim any and all liability for any errors or inaccuracies contained in this data sheet. While Raltron/RAMI Tech has made every reasonable effort ensure the accuracy of all product information, specifications and data contained herein, Raltron/RAMI Tech does not guarantee that the information is accurate, reliable or current. The product information is provided only for reference purposes only and is subject to change, correction or revision, at any time without notice. Raltron/RAMI Tech does not assume any liability arising out of an application or use of any product described herein and disclaims any warranties expressed or implied. The user of products in such applications shall assume all risks of such use and will agree to hold Raltron/RAMI Tech, harmless against all damages.

Copyright © 2016, Raltron Electronics / RAMI Technology USA, LLC. All rights reserved. No part of this document may be reproduced in any form without the prior written permission of Raltron Electronics / RAMI Technology USA, LLC.