

SUMMARY

Wires

Coax 1

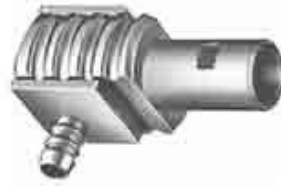

Image is for illustrative purpose only

Series 00
Termination type Male solder
IP rating 50
AWG wire size 0.00 - 0.00
Cable Ø 0.00 - 5.40 mm
Status active
Matching parts [ERA.00.250.NTL](#)

Download

[Request a quote](#)

[Catalog](#)

TECHNICAL DETAILS

Mechanics

Shell Style/Model FLV*: Elbow plug cable crimping with improved screen efficiency
Keying Circular, male
Housing Material Brass (nickel plated [SAE AMS QQ N 290]) shell, collet nut, latch sleeve and mid pieces
Weight 4.64 g

Performance

Configuration 00.250 : 1 Coax (50 Ohm)
Insulator T: PTFE
Rated Current 4 Amps

Specifications

Contact Type: Coaxial 50 Ohm (Solder)
Contact Dia.: 0.7 mm (0.028in)
Bucket Dia.: 0.6 mm (0.024in)
Test voltage: 2.1 kV (rms)
R (max): 6.1 mOhm
Vtest: 2100 V (AC), 3000 V (DC)
□
Impedance: 50 Ohm
VSWR: 1.09 + 0.11 * f /GHz

LEMO products and services are provided "as is". LEMO makes no warranties or representations with regard to LEMO product & services or use of them, express, implied or statutory, including for accuracy, completeness, or security. The user is fully responsible for his products and applications using LEMO components.

Others

Endurance (Shell): 5000 mating cycles

F ret (min): 100 N

Salt Spray Corrosion: >144 hr

DRAWINGS

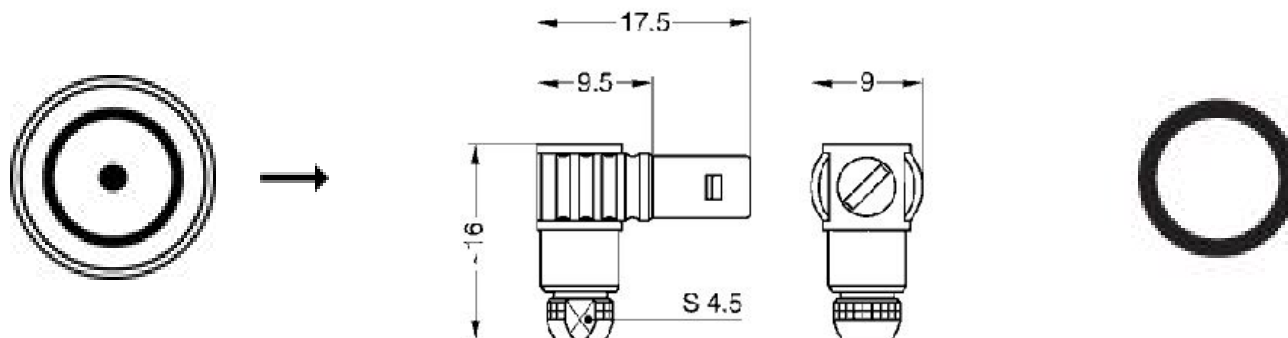

Dimensions

| | A | H | L |
|-----|------|------|------|
| mm. | 9 | 15 | 17.5 |
| in. | 0,35 | 0,59 | 0,69 |

RECOMMENDED BY LEMO







Tools

Crimp Tool: [DPE.99.176.2K](#)

Die Tool: [DPN.99.176.2K](#)

Cables

LEMO products and services are provided "as is". LEMO makes no warranties or representations with regard to LEMO product & services or use of them, express, implied or statutory, including for accuracy, completeness, or security. The user is fully responsible for his products and applications using LEMO components.

| | | | |
|---------------------|-----------|-------|--|
| 17420 | PVC | Black |  |
| 17450 | COPOLYMER | Black |  |
| 178190 | PTFE | Brown | |
| 18000 | PTFE | Brown |  |
| 18700 | PTFE | White |  |
| 18800 | PTFE | White | |
| 196270 | PTFE | White | |
| 31600 | PTFE | Brown | |
| CCX.50.030.083.180B | | White | |
| CCX.50.RG0.58AU14B | FEP | White | |
| CCX.50.RG1.74-U25N | PVC | Black | |
| CCX.50.RG1.74AU28N | PVC | Black | |
| CCX.50.RG1.74AU28N | PVC | Black |  |
| CCX.50.RG1.74U25N | PVC | Black | |
| CCX.50.RG1.78BU18M | FEP | Brown | |
| CCX.50.RG1.78BU18M | PTFE | Brown | |
| CCX.50.RG1.88AU24B | TFE | White | |
| CCX.50.RG1.88AU26B | PFA | White | |
| CCX.50.RG1.88AU26B | PTFE | White | |
| CCX.50.RG1.96AU19B | PTFE | White | |
| CCX.50.RG1.96AU20B | PFA | White | |
| CCX.50.RG3.16BU26M | FEP | Brown | |
| CCX.50.RG3.16U28M | PTFE | Brown | |
| CCX.75.040.195327G | PVC | Grey | |
| CCX.75.RG1.79BU26M | FEP | Brown | |
| CCX.75.RG1.87AU26B | PFA | White | |
| CCX.75.RG1.87AU27B | PTFE | White |  |
| CCX.95.RG1.80BU36M | PTFE | Brown |  |
| CCX.95.RG1.95AU37B | PFA | White | |

LEMO products and services are provided "as is". LEMO makes no warranties or representations with regard to LEMO product & services or use of them, express, implied or statutory, including for accuracy, completeness, or security. The user is fully responsible for his products and applications using LEMO components.