

MAX6672/MAX6673

PWM Output Temperature Sensors in SC70 Packages

General Description

The MAX6672/MAX6673 are low-current temperature sensors with a single-wire output. These temperature sensors convert the ambient temperature into a 1.4kHz PWM output, which contains the temperature information in its duty cycle. The MAX6672 has an open-drain output and the MAX6673 has a push-pull output.

The MAX6672/MAX6673 operate from 2.4V to 5.5V with a maximum supply current of 150µA. Both devices feature a single-wire output that minimizes the number of pins necessary to interface with a microprocessor.

The MAX6672/MAX6673 are available in 5-pin SC70 packages.

Applications

- Industrial and Process Control
- HVAC
- Environmental Control
- Isolated Temperature Sensing

Features

- Simple Single-Wire PWM Output
- Tiny SC70 Package
- Low 60µA (typ) Supply Current Consumption
- 1.4kHz Nominal Frequency
- Choice of Outputs
 - Open Drain (MAX6672)
 - Push-Pull (MAX6673)
- 2.4V to 5.5V Supply Range

Ordering Information

| PART | TEMP RANGE | PIN-PACKAGE | TOP MARK |
|--------------|-----------------|-------------|----------|
| MAX6672AXK-T | -40°C to +125°C | 5 SC70 | ACQ |
| MAX6673AXK-T | -40°C to +125°C | 5 SC70 | ACR |

Typical Application Circuit

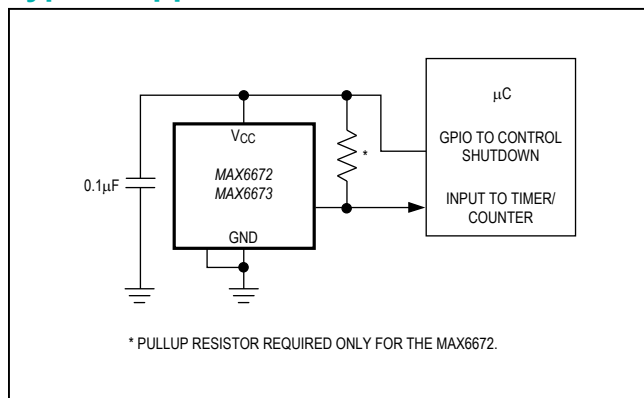

Pin Configuration

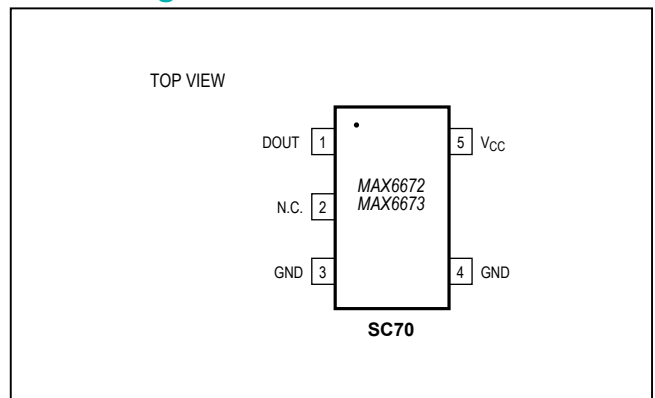

Absolute Maximum Ratings

| | | | |
|---|-----------------------------------|--|-----------------|
| Supply Voltage (V _{CC} to GND)..... | -0.3V to +6V | Operating Temperature Range..... | -40°C to +125°C |
| DOUT to GND (MAX6672)..... | -0.3V to +6V | Storage Temperature Range..... | -65°C to +150°C |
| DOUT to GND (MAX6673)..... | -0.3V to (V _{CC} + 0.3V) | Junction Temperature..... | +150°C |
| DOUT Short to GND..... | Continuous | SC70 Package | |
| ESD Protection (Human Body Model)..... | ±2000V | Vapor Phase (60s)..... | +215°C |
| Continuous Power Dissipation (T _A = +70°C) | | Infrared (15s)..... | +220°C |
| 5-Pin SC70 (derate 2.5mW/°C above +70°C)..... | 200mW | Lead Temperature (soldering, 10s)..... | +300°C |

Stresses beyond those listed under "Absolute Maximum Ratings" may cause permanent damage to the device. These are stress ratings only, and functional operation of the device at these or any other conditions beyond those indicated in the operational sections of the specifications is not implied. Exposure to absolute maximum rating conditions for extended periods may affect device reliability.

Electrical Characteristics

(V_{CC} = 2.4V to 5.5V, T_A = -40°C to +125°C, unless otherwise noted. Typical values specified at +25°C and V_{CC} of 3.3V.) (Note 1)

| PARAMETER | SYMBOL | CONDITIONS | MIN | TYP | MAX | UNITS | |
|------------------------------------|-------------------|--|----------------------------------|-----|-----|-------|----|
| Temperature Error (Note 2) | | V _{CC} = 3.3V | T _A = +25°C to +100°C | -3 | | +3 | °C |
| | | | T _A = 0°C to +125°C | -4 | | +4 | |
| | | | T _A = -20°C to +125°C | -5 | | +5 | |
| | | | T _A = -40°C to -20°C | | ±3 | | |
| Nominal t ₁ Pulse Width | | | | 280 | | µs | |
| Output Low Voltage | V _{OL} | I _{SINK} = 3mA | | | 0.4 | V | |
| Output High Voltage | V _{OH} | I _{SOURCE} = 800µA (MAX6673) | V _{CC} - 0.5 | | | V | |
| Fall Time | t _{FALL} | C _{LOAD} = 100pF | | 14 | | ns | |
| Rise Time | t _{RISE} | C _{LOAD} = 100pF (MAX6673) | | 96 | | ns | |
| DOUT Open-Drain Leakage Current | | V _{DOUT} = 6V (MAX6672) | | 0.1 | | µA | |
| Output Capacitance | | | | 2.5 | | pF | |
| Power-Supply Rejection Ratio | PSRR | 2.4V to 5.5V, T _A = -25°C to +125°C | | 0.3 | 0.8 | °C/V | |
| Supply Current | I _{CC} | 2.4V to 3.6V | | 60 | 100 | µA | |
| | | 3.6V to 5.5V | | 70 | 150 | | |

Note 1: All specifications are 100% tested at T_A = +25°C. Specification limits over temperature (T_A = -40°C to +125°C) are guaranteed by design, not production tested.

Note 2: Temperature = -200 × (0.85 - T₁/T₂)³ + (425.5 T₁/T₂) - 273. T₁ is the low time period. T₂ is the high time period (Figure 1).

Typical Operating Characteristics

($V_{CC} = 3.3V$, $T_A = +25^\circ C$, unless otherwise noted.)

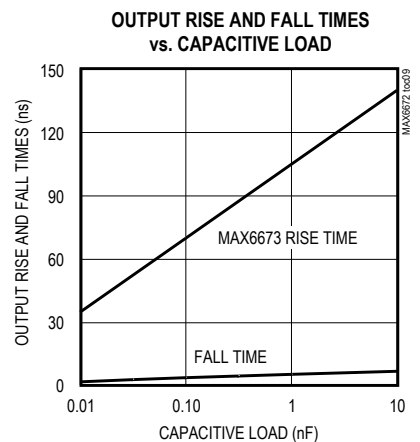
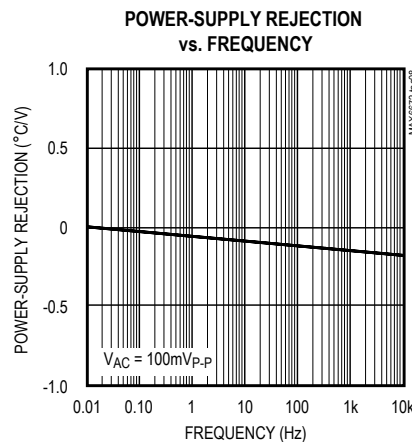
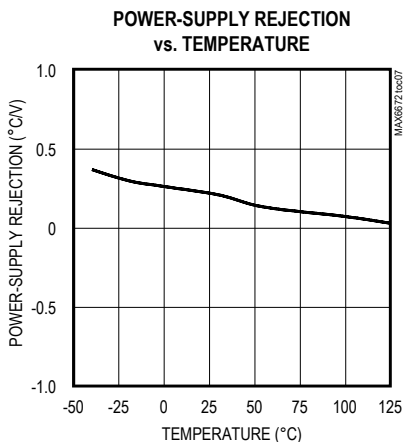
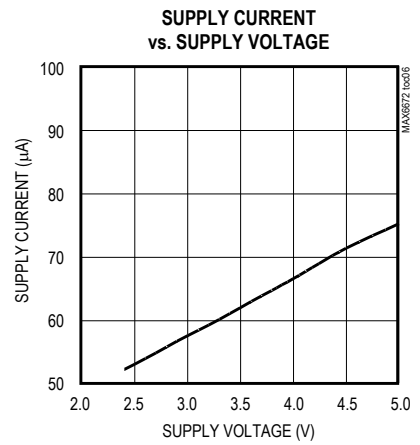
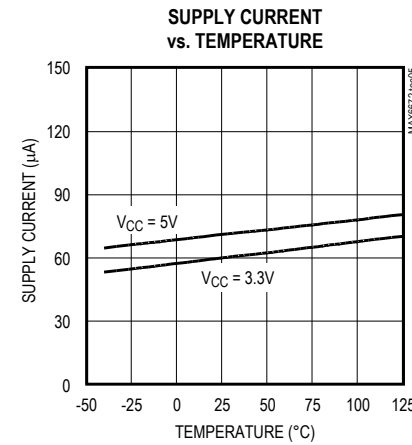
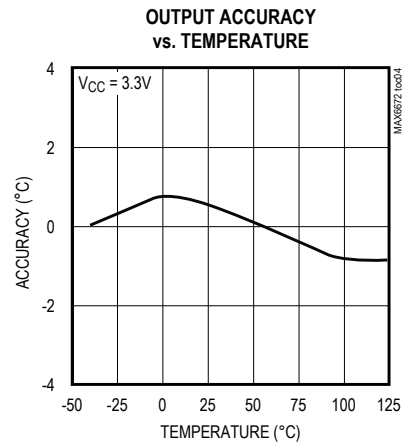
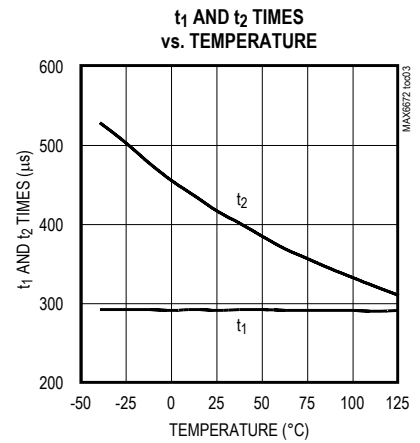
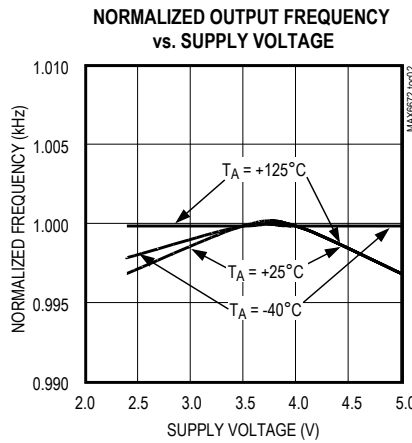
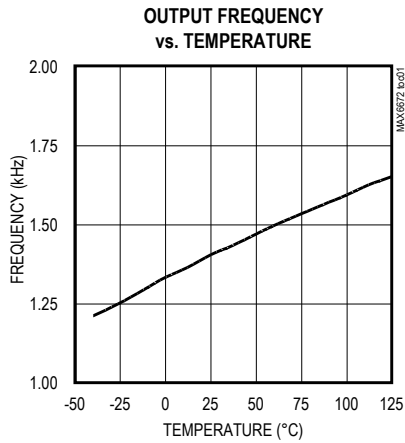

Typical Operating Characteristics (continued)

(V_{CC} = 3.3V, T_A = +25°C, unless otherwise noted.)

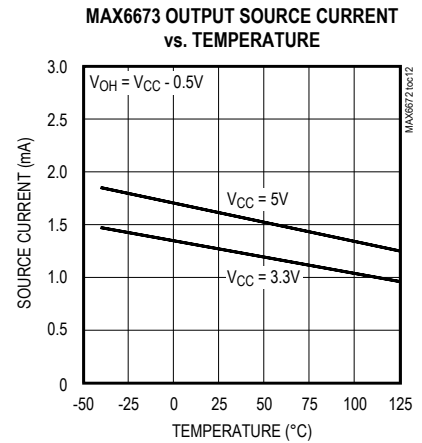
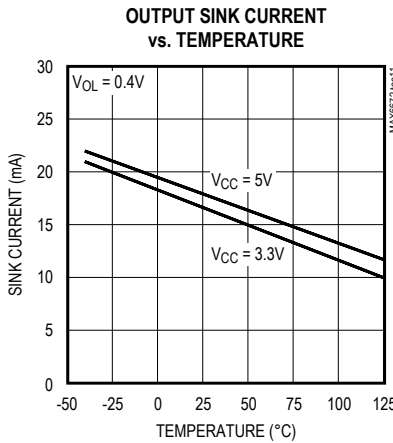
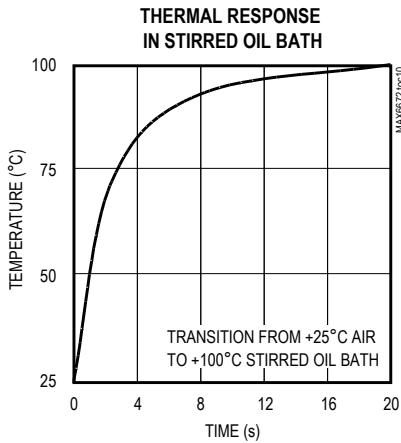

Pin Description

| PIN | NAME | FUNCTION |
|------|-----------------|---|
| 1 | DOUT | Digital Output Pin. PWM output, open-drain output (MAX6672), or push-pull output (MAX6673). |
| 2 | N.C. | No Connection. Not internally connected. |
| 3, 4 | GND | Pin 3 and Pin 4 must be tied together and connected to ground. |
| 5 | V _{CC} | Positive Supply. Bypass with a 0.1µF capacitor to GND. |

Detailed Description

The MAX6672/MAX6673 are low-current (60µA, typ), local temperature sensors ideal for interfacing with µCs or µPs. The MAX6672/MAX6673 convert their own temperature into a ratiometric PWM output. The square-wave output waveform time ratio contains the temperature information. The output is a square wave with a nominal frequency of 1.4kHz at +25°C. The temperature is obtained with the following formula:

$$\text{Temperature } (^{\circ}\text{C}) = -200 \times (0.85 - t_1 / t_2)^3 + (425 \times t_1 / t_2) - 273$$

Where t₁ is a fixed value and t₂ is modulated with the temperature. Table 1 lists time ratio vs. temperature.

For temperatures greater than +50°C, the temperature error is primarily first order and the following equation can be used:

$$\text{Temperature } (^{\circ}\text{C}) = (425 \times t_1 / t_2) - 273$$

The MAX6673 has a push-pull output. The rise and fall times of the MAX6673 output are negligible with respect to the period; therefore, errors caused by capacitive loading are minimized.

The output load capacitance should be minimized in MAX6672 applications because the sourcing current is set by the pullup resistor. If the output capacitance becomes too large, unequal rise and fall times distort the pulse width, thus delivering inaccurate readings.

Applications Information

Pulse-Width Modulation

Interfacing with a µC

The *Typical Application Circuit* shows the MAX6672/MAX6673 interfaced with a µC. In this example, the MAX6672/MAX6673 convert the ambient temperature to a PWM waveform. The µC reads the temperature by measuring the t₁ and t₂ periods in software and hardware. The only timing requirements are that the clock frequency used for timing measurements is stable and

Table 1. Time Ratio vs. Temperature

| TIME RATIO (t_1/t_2) | TEMPERATURE (°C) |
|-----------------------------|---------------------|
| 0.936 | 125 |
| 0.878 | 100 |
| 0.807 | 70 |
| 0.714 | 30 |
| 0.646 | 0 |
| 0.602 | -25 |
| 0.560 | -40 |

high enough to provide the required measurement resolution. The interface for the MAX6672 requires a pullup resistor.

Thermal Response Time

The time periods t_1 (low) and t_2 (high) are values that are easily read by the μ P timer/counter. The temperature reading is then calculated using software. Since both periods are obtained consecutively, using the same clock, performing the division indicated in the above formulae results in a ratiometric value that is independent of the exact frequency.

Sensing Circuit Board and Ambient Temperatures

Temperature sensor ICs such as the MAX6672/MAX6673 that sense their own die temperatures must be mounted on or close to the object whose temperature they are intended to measure. Because there is a good thermal path between the SC70 package's metal leads and the IC die, the MAX6672/MAX6673 can accurately measure the temperature of the circuit board to which they are soldered. If the sensor is intended to measure the temperature of a heat-generating component on the circuit board, it should be mounted as close as possible to that component and should share supply and ground traces (if they are not noisy) with that component where possible. This maximizes the heat transfer from the component to the sensor.

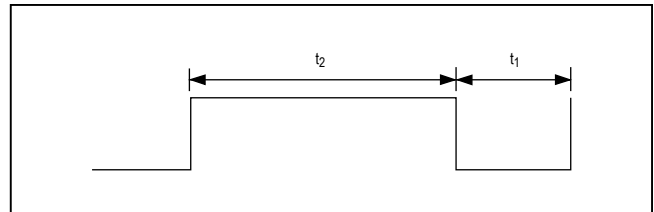
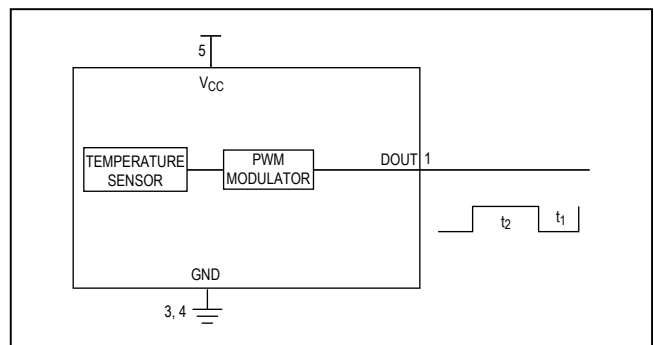

Figure 1. PWM Waveform Timing

Block Diagram



The thermal path between the plastic package and the die is not as good as the path through the leads, so the MAX6672/MAX6673, like all temperature sensors in plastic packages, are less sensitive to the temperature of the surrounding air than they are to the temperature of their leads. They can be successfully used to sense ambient temperature if the circuit board is designed to track the ambient temperature.

As with any IC, the wiring and circuits must be kept insulated and dry to avoid leakage and corrosion, especially if the part is operated at cold temperatures where condensation can occur.

The error caused by power dissipation in the MAX6672/MAX6673 is negligible.

Chip Information

PROCESS: BiCMOS

Package Information

For the latest package outline information and land patterns (footprints), go to www.maximintegrated.com/packages. Note that a "+", "#", or "-" in the package code indicates RoHS status only. Package drawings may show a different suffix character, but the drawing pertains to the package regardless of RoHS status.

| PACKAGE TYPE | PACKAGE CODE | DOCUMENT NO. | LAND PATTERN NO. |
|--------------|--------------|-------------------------|-------------------------|
| 5 SC70 | X5-1 | 21-0076 | 90-0188 |

Revision History

| REVISION NUMBER | REVISION DATE | DESCRIPTION | PAGES CHANGED |
|-----------------|---------------|---|---------------|
| 0 | 10/02 | Initial release | — |
| 1 | 4/14 | Removed automotive reference from <i>Applications</i> | 1 |

For pricing, delivery, and ordering information, please contact Maxim Direct at 1-888-629-4642, or visit Maxim Integrated's website at www.maximintegrated.com.

Maxim Integrated cannot assume responsibility for use of any circuitry other than circuitry entirely embodied in a Maxim Integrated product. No circuit patent licenses are implied. Maxim Integrated reserves the right to change the circuitry and specifications without notice at any time. The parametric values (min and max limits) shown in the Electrical Characteristics table are guaranteed. Other parametric values quoted in this data sheet are provided for guidance.