

PHASE CONTROL THYRISTORS

Stud Version

Features

- High current and high surge ratings
- $dv/dt = 1000V/\mu s$ option
- Ceramic housing
- Threaded studs UNF 1/2 - 20UNF2A
- Types up to $1200V V_{RRM}/V_{DRM}$
- $di/dt = 300A/\mu s$

110A

Typical Applications

- DC motor controls
- Controlled DC power supplies
- AC controllers

Major Ratings and Characteristics

Parameters	111RKI	Units
$I_{T(AV)}$	110	A
@ T_C	90	°C
$I_{T(RMS)}$	172	A
I_{TSM} @ 50Hz	2080	A
@ 60Hz	2180	A
I^2t @ 50Hz	21.7	KA ² s
@ 60Hz	19.8	KA ² s
V_{DRM}/V_{RRM}	400 to 1200	V
t_q typical	110	μs
T_J	- 40 to 140	°C

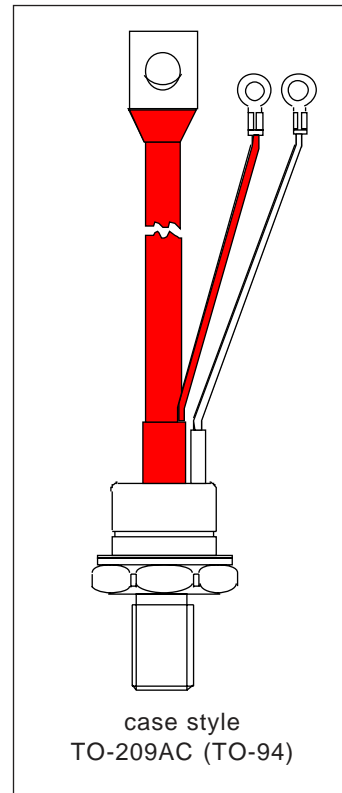

111RKI Series

Bulletin I25152 rev. C 05/97

International
IR Rectifier

ELECTRICAL SPECIFICATIONS

Voltage Ratings

Type number	Voltage Code	V_{DRM}/V_{RRM} , max. repetitive peak and off-state voltage V	V_{RSM} , maximum non-repetitive peak voltage V	I_{DRM}/I_{RRM} max. @ $T_J = T_J$ max. mA
111RKI	40	400	500	20
	80	800	900	
	120	1200	1300	

On-state Conduction

Parameter	111RKI	Units	Conditions
$I_{T(AV)}$ Max. average on-state current @ Case temperature	110 90	A °C	180° conduction, half sine wave
$I_{T(RMS)}$ Max. RMS on-state current	172		DC @ 83°C case temperature
I_{TSM} Max. peak, one-cycle non-repetitive surge current	2080	A	t = 10ms No voltage reappplied
	2180		t = 8.3ms
	1750		t = 10ms 100% V_{RRM} reappplied
	1830		t = 8.3ms
I^2t Maximum I^2t for fusing	21.7	KA ² s	t = 10ms No voltage reappplied
	19.8		t = 8.3ms
	15.3		t = 10ms 100% V_{RRM} reappplied
	14.0		t = 8.3ms
$I^2\sqrt{t}$ Maximum $I^2\sqrt{t}$ for fusing	217	KA ² √s	t = 0.1 to 10ms, no voltage reappplied
$V_{T(TO)1}$ Low level value of threshold voltage	0.82	V	$(16.7\% \times \pi \times I_{T(AV)} < I < \pi \times I_{T(AV)})$, $T_J = T_J$ max.
$V_{T(TO)2}$ High level value of threshold voltage	1.02		$(I > \pi \times I_{T(AV)})$, $T_J = T_J$ max.
r_{t1} Low level value of on-state slope resistance	2.16	mΩ	$(16.7\% \times \pi \times I_{T(AV)} < I < \pi \times I_{T(AV)})$, $T_J = T_J$ max.
r_{t2} High level value of on-state slope resistance	1.70		$(I > \pi \times I_{T(AV)})$, $T_J = T_J$ max.
V_{TM} Max. on-state voltage	1.57	V	$I_{pk} = 350A$, $T_J = T_J$ max., $t_p = 10ms$ sine pulse
I_H Maximum holding current	200	mA	$T_J = 25^\circ C$, anode supply 6V resistive load
I_L Typical latching current	400		

Switching

Parameter	111RKI	Units	Conditions
di/dt Max. non-repetitive rate of rise of turned-on current	300	A/μs	Gate drive 20V, 20Ω, $t_r \leq 1\mu s$ $T_J = T_J$ max, anode voltage $\leq 80\% V_{DRM}$
t_d Typical delay time	1	μs	Gate current 1A, $di_g/dt = 1A/\mu s$ $V_d = 0.67\% V_{DRM}$, $T_J = 25^\circ C$
t_q Typical turn-off time	110		$I_{TM} = 50A$, $T_J = T_J$ max., $di/dt = -5A/\mu s$, $V_R = 50V$ $dv/dt = 20V/\mu s$, Gate 0V 25Ω

Blocking

Parameter	111RKI	Units	Conditions
dv/dt Maximum critical rate of rise of off-state voltage	500	V/ μ s	$T_J = T_J$ max. linear to 80% rated V_{DRM}
I_{RRM} I_{DRM} Max. peak reverse and off-state leakage current	20	mA	$T_J = T_J$ max, rated V_{DRM}/V_{RRM} applied

Triggering

Parameter	111RKI		Units	Conditions
P_{GM} Maximum peak gate power	12		W	$T_J = T_J$ max, $t_p \leq 5$ ms
$P_{G(AV)}$ Maximum average gate power	3.0			
I_{GM} Max. peak positive gate current	3.0		A	$T_J = T_J$ max, $t_p \leq 5$ ms
$+V_{GM}$ Maximum peak positive gate voltage	20		V	$T_J = T_J$ max, $t_p \leq 5$ ms
$-V_{GM}$ Maximum peak negative gate voltage	10			
I_{GT} DC gate current required to trigger	TYP.	MAX.	mA	$T_J = -40^\circ\text{C}$ $T_J = 25^\circ\text{C}$ $T_J = 140^\circ\text{C}$ Max. required gate trigger/ current/ voltage are the lowest value which will trigger all units 12V anode-to-cathode applied
	180	-		
	80 40	120 -		
V_{GT} DC gate voltage required to trigger	2.5	-	V	$T_J = -40^\circ\text{C}$ $T_J = 25^\circ\text{C}$ $T_J = 140^\circ\text{C}$
	1.6	2		
	1	-		
I_{GD} DC gate current not to trigger	6.0		mA	Max. gate current/ voltage not to trigger is the max. value which will not trigger any unit with rated V_{DRM} anode-to-cathode applied
V_{GD} DC gate voltage not to trigger	0.25		V	

Thermal and Mechanical Specification

Parameter	111RKI	Units	Conditions
T_J Max. operating temperature range	-40 to 140	$^\circ\text{C}$	
T_{stg} Max. storage temperature range	-40 to 150		
R_{thJC} Max. thermal resistance, junction to case	0.27	K/W	DC operation
R_{thCS} Max. thermal resistance, case to heatsink	0.1		Mounting surface, smooth, flat and greased
T Mounting torque, $\pm 10\%$	15.5	Nm (lbf-in)	Non lubricated threads
	(137)		Lubricated threads
	14 (120)		
wt Approximate weight	130	g	
Case style	TO - 209AC (TO-94)		See Outline Table

111RKI Series

Bulletin I25152 rev. C 05/97



ΔR_{thJC} Conduction

(The following table shows the increment of thermal resistance R_{thJC} when devices operate at different conduction angles than DC)

Conduction angle	Sinusoidal conduction	Rectangular conduction	Units	Conditions
180°	0.043	0.031	K/W	$T_J = T_J \text{ max.}$
120°	0.052	0.053		
90°	0.066	0.071		
60°	0.096	0.101		
30°	0.167	0.169		

Ordering Information Table

Device Code

11	1	RKI	120
①	②	③	④

- 1** - $I_{T(AV)}$ rated average output current (rounded/10)
- 2** - 0 = Eyelet terminals (Gate and Auxiliary Cathode Leads)
1 = Fast - on terminals (Gate and Auxiliary Cathode Leads)
2 = Flag terminals (For Cathode and Gate Terminals)
- 3** - Thyristor
- 4** - Voltage code: Code x 10 = V_{RRM} (See Voltage Rating Table)
- 5** - Critical dv/dt: None = 500V/ μ sec
S90 = 1000V/ μ sec

Outline Table

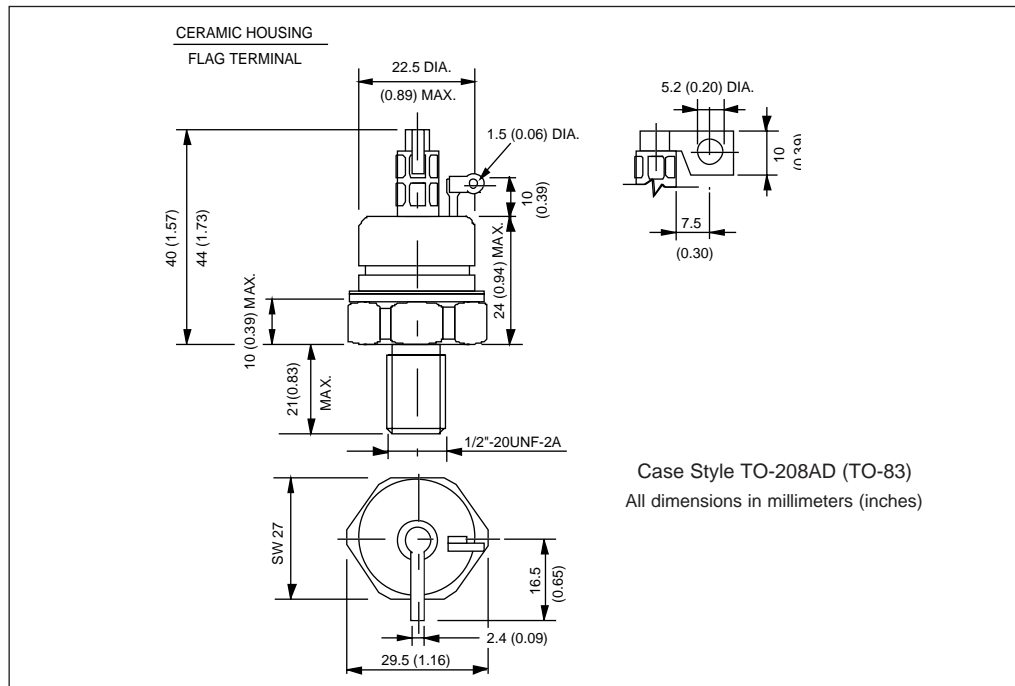

Outline Table

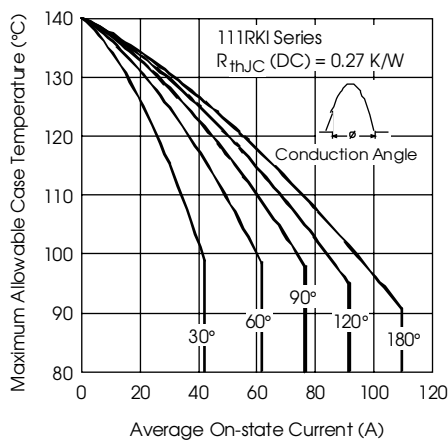
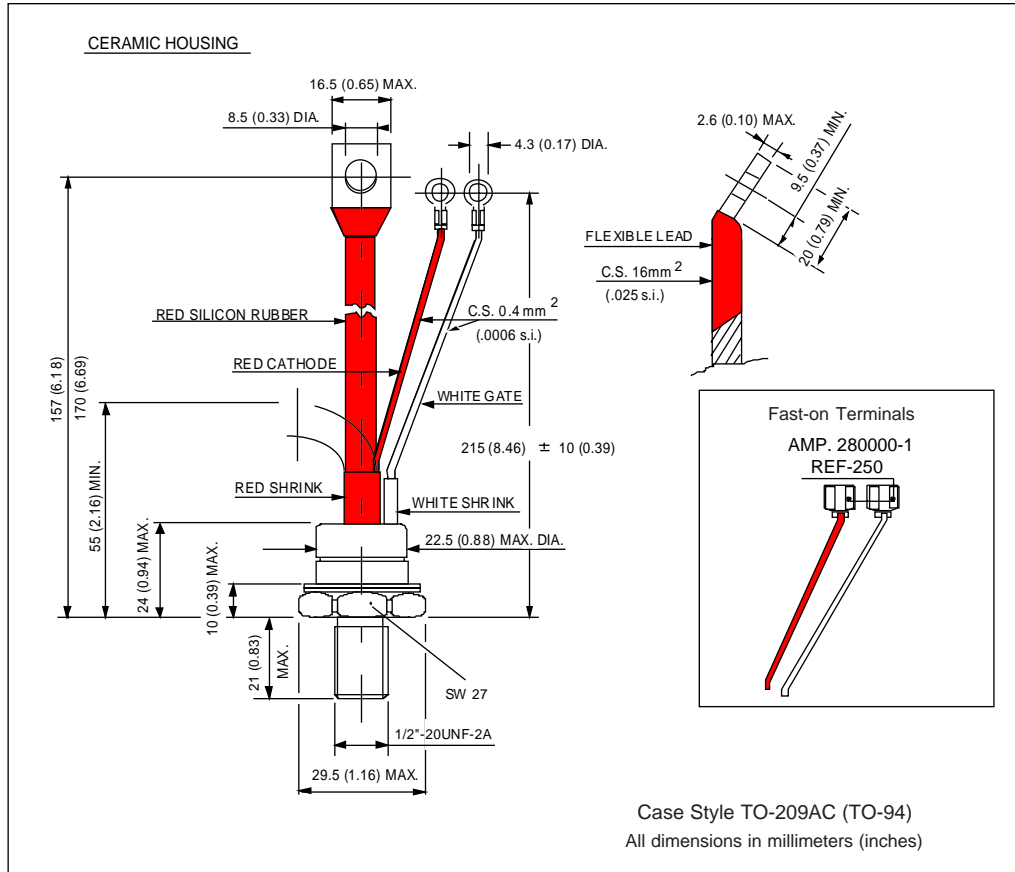

Fig. 1 - Current Ratings Characteristics

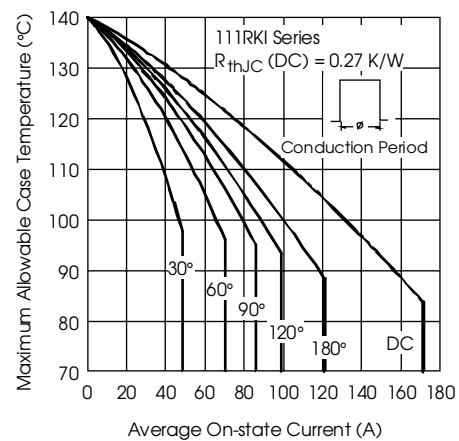

Fig. 2 - Current Ratings Characteristics

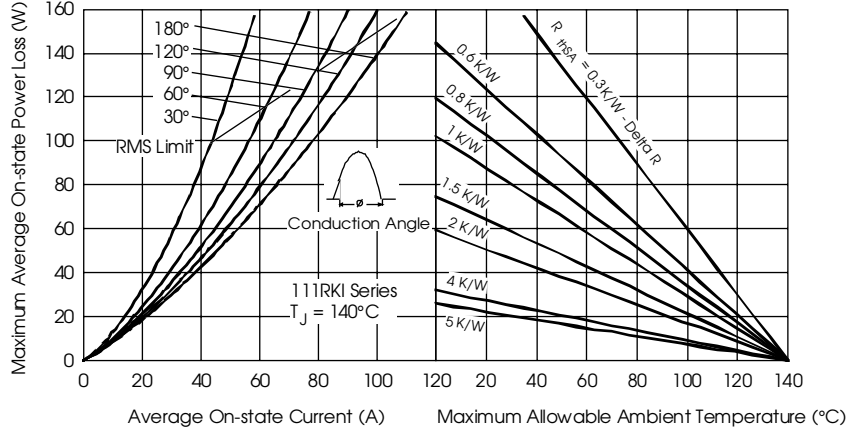

Fig. 3 - On-state Power Loss Characteristics

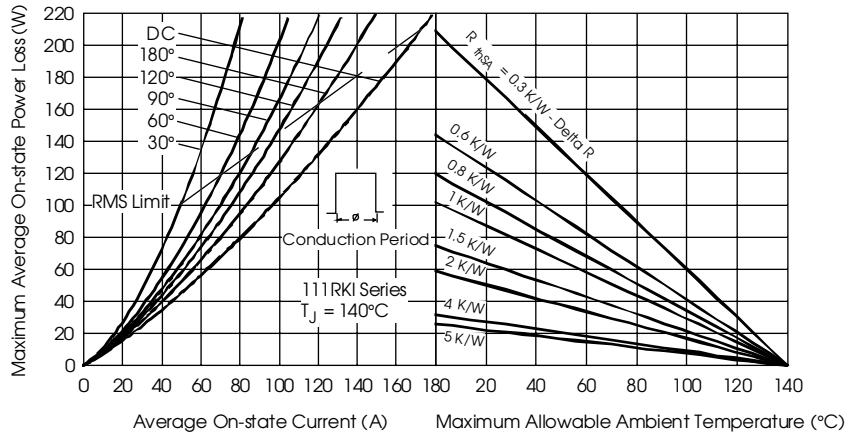

Fig. 4 - On-state Power Loss Characteristics

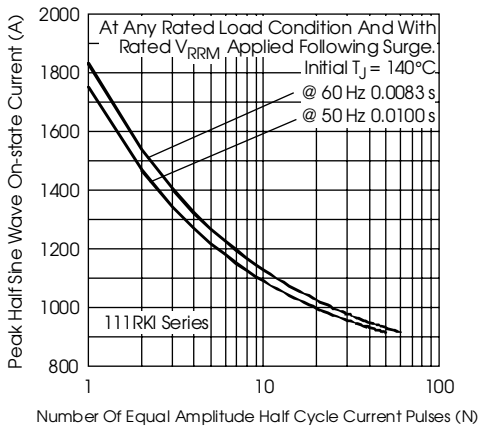

Fig. 5 - Maximum Non-Repetitive Surge Current

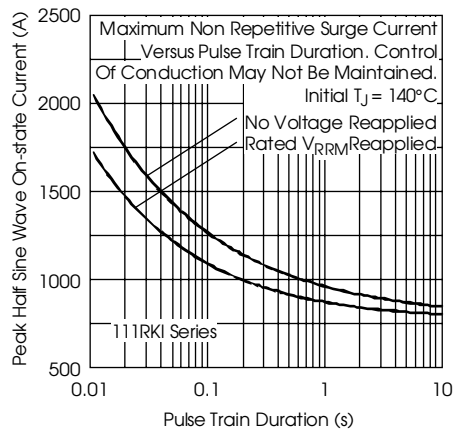

Fig. 6 - Maximum Non-Repetitive Surge Current

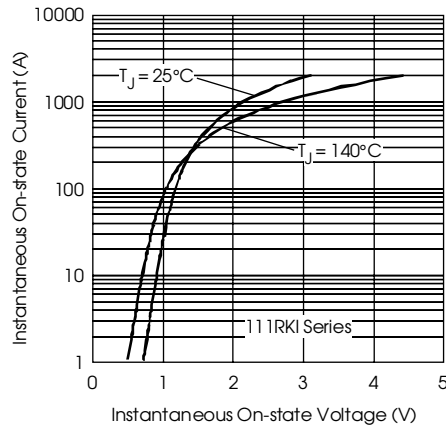

Fig. 7 - On-state Voltage Drop Characteristics

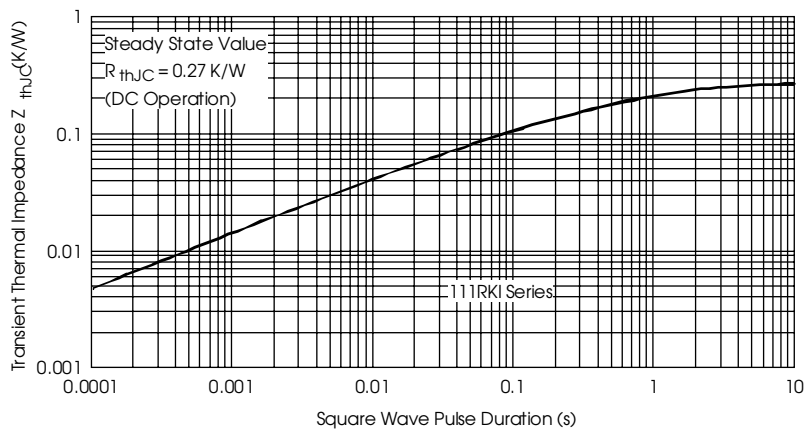

Fig. 8 - Thermal Impedance Z_{thJC} Characteristic

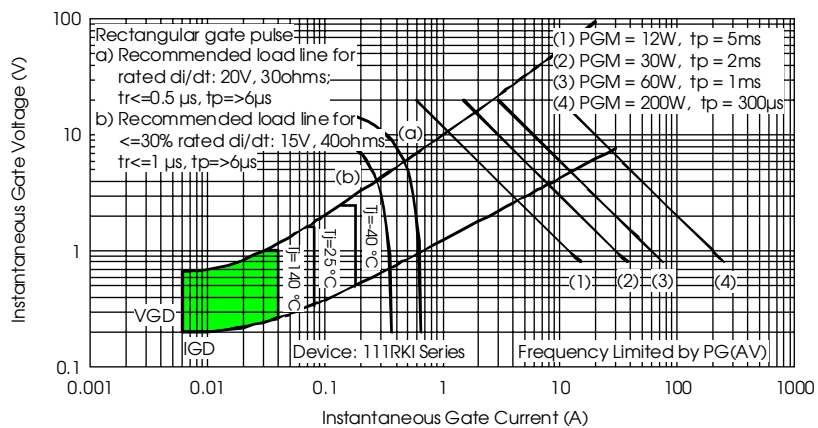

Fig. 9 - Gate Characteristics