

qGround DIY IOT Adafruit Feather Compatible PCB Kit

User Manual

Abstract

User Manual describing the qGround AFC DIY IOT PCB Kits.
Kits features, content and usage examples provided.

IBT-QGX-AFC-X-UM

www.iot-bots.com





Table of Contents

Revision History	2
Overview.....	3
Features.....	3
Description	3
qGround AFC PCB Kit overview	4
PCB overview	7
Enclosure option	9
Specification	10
qGround AFC Enclosure Kit content.....	10
Usage examples	11
Abbreviations.....	11
Trademark notice.....	12
Ordering info	12



Revision History

NoNo	Version	Date	Author	Description
1	1.0	01.07.2021	lotbotscom	Initial
2				
3				



Overview

"Nice to have" for any DIY IOT project, qGround AFC PCB Kit is the part of the newest HW PCB Kits line designed to help hobbyists, makers and all DIYers to build IOT POCs and making HW prototyping easily.

Features

- High quality PCB : Double-sided FR-4 PCB with 0.1" hole spacing for DIP integrated circuits, modules, and main controller board;
- Dedicated placement for controller board : Well-designed PCB allows to carry Adafruit Feather Compatible MCU board;
- Rich set of interface options : Four terminal blocks, Grove I2C and 4-pin JST I2C&Power, low profile 0.1" Adafruit Feather Compatible interface connectors;
- More space for prototyping : Proto holes grid across whole PCB space for DIP components installation and wiring;
- Environmental ready : Developed to be perfectly fit and mounted inside qBox Collection Enclosures for indoor and outdoor DIY IOT projects.

Description

qGround AFC PCB Kits are part of qGround AxC PCB Kits line and developed especially to be used with AFC or Adaa boards. So, each PCB kit has dedicated connectors main CPU board could be plugged in (AFC or AMC).

The PCB of qGround AFC PCB Kit is used as PCB board of qBox AFC Enclosure Kits.

Each qGround AxC PCB kit consists of high-quality double sided PCB with rich set of connectors installed and the set of 3,5mm terminal plugs.

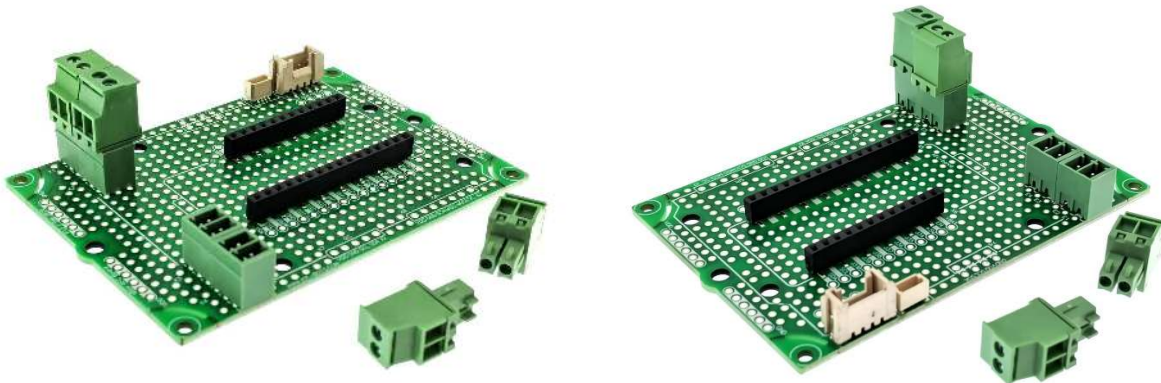

Pic.1. qGround AFC PCB Kit common view

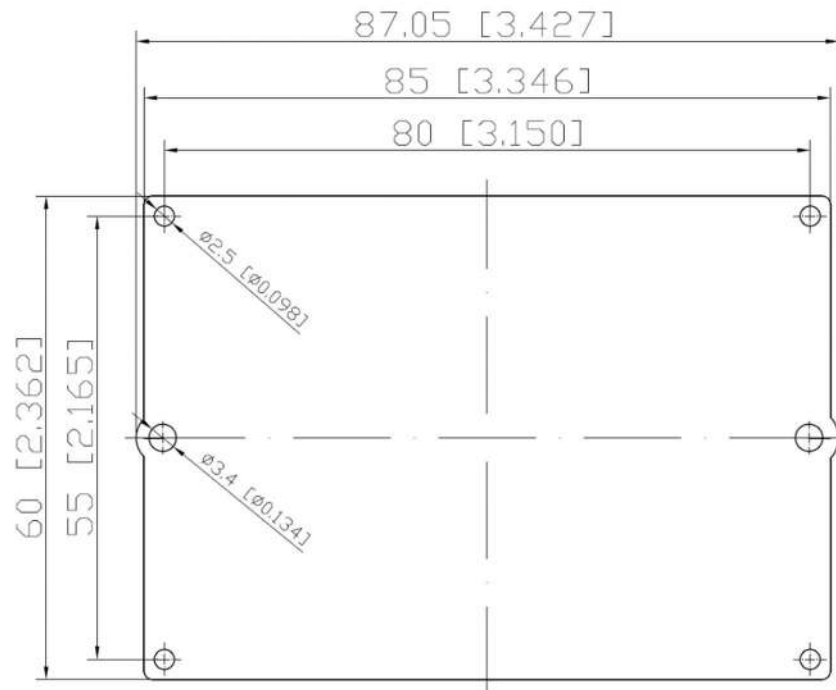

Pic. 2. qGround AFC PCB Kit PCB dimensions

qGround AFC PCB Kit overview

Kit's PCB has enough space to keep one Adafruit Feather Compatible (AFC) IOT board, power supply (DC/DC), OLED display and sensor modules, as example, using plain grid proto holes.

Each board has got four pluggable 3,5mm terminal blocks, one Grove, one 4-pin JST and two low profile pass-through 0,1" SMT AFC interface compatible connectors

installed. Several DIP 0.1" I2C and SPI interface connectors could be populated. Two separate power traces for VDD and GND along short PCB sides allow bring the power to sensor boards.

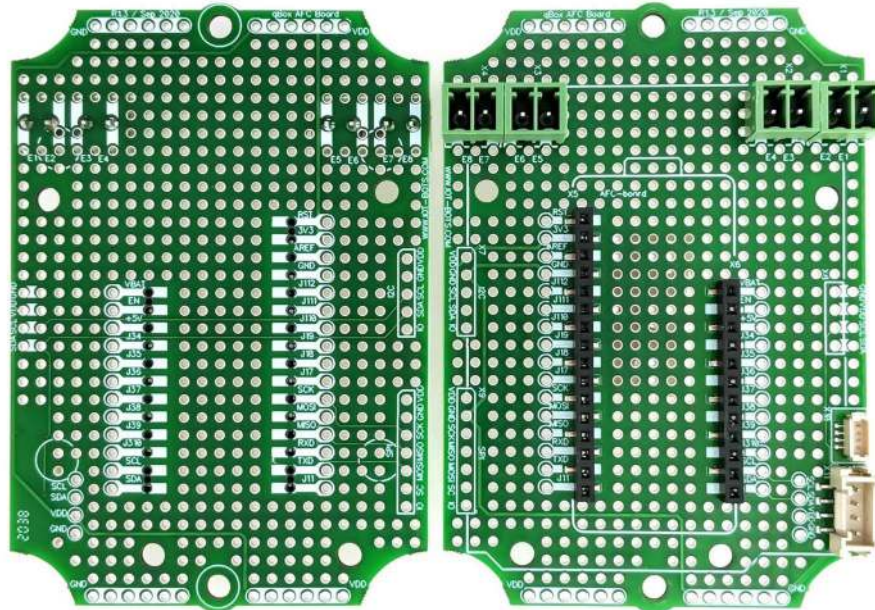

Pic.3. qGround AFC PCB Kit board common view
(Front and Back, no corners)

Each AFC connector pin has got a trace with DIP contacts that wires from other modules could be easily soldering.

Connector list:

- X1: External power connection through pluggable 3,5mm terminal block;
- X2...X4: External Input / Output sensor / actuator connections through pluggable 3,5mm terminal blocks;
- X5, X6: IOT board connectors (low profile 0,1" pass through SMT receptacle);
- X7: I2C sensors connector placement (0,1" DIP) with pins: VDD, GND, SCL, SDA, IO;
- X8: OLED I2C connector placement (0,1" DIP) with pins: VDD, GND, SCL, SDA;
- X9: SPI sensors connector placement (0,1" DIP) with pins: VDD, GND, SCK, MISO, MOSI, CS, IO;

- X10: 4 pins JST I2C&Power connector with pins: VDD, GND, SCL, SDA;
- X11: 4 pins Grove compatible I2C&Power connector (2,0 mm SMT) with pins: VDD, GND, SCL, SDA.

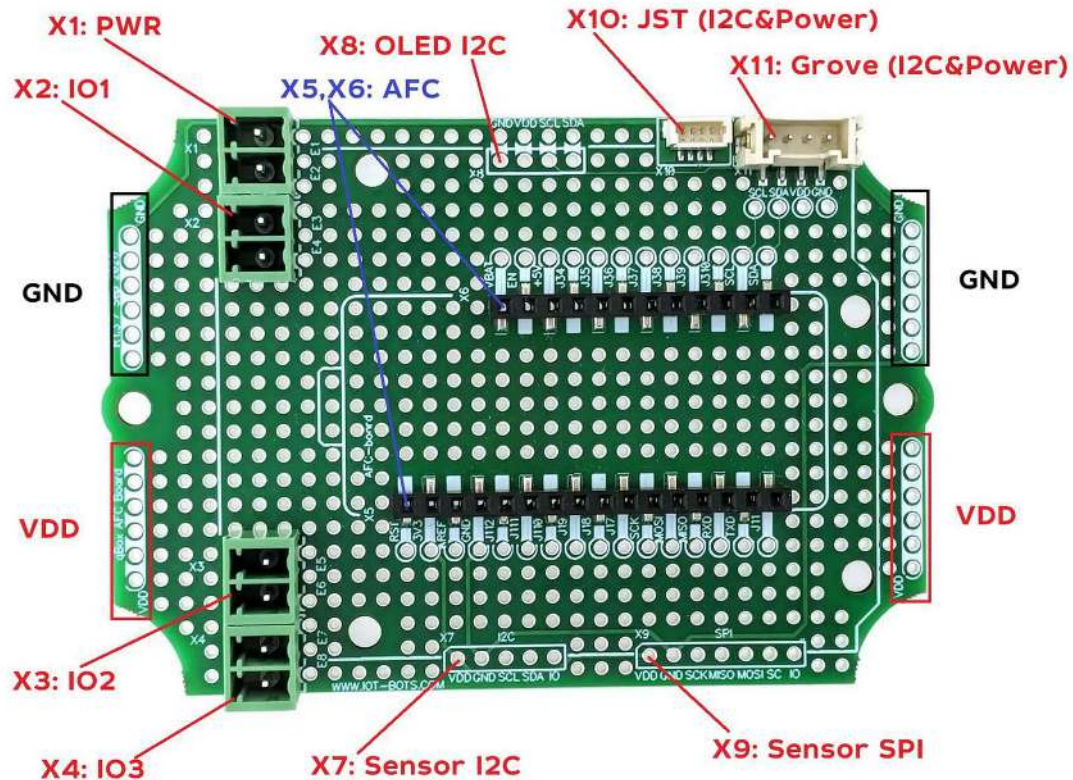

Pic.4. qGround AFC PCB Connectors (no corners)

There are VDD, GND and I2C connections between appropriate connectors pins and CPU board, so no needs to make these connections separately, just plug a CPU board and I2C sensors to Grove or JST connectors and get solution working. Two separate power traces for VDD and GND along short PCB sides allow bring the power to sensor boards.

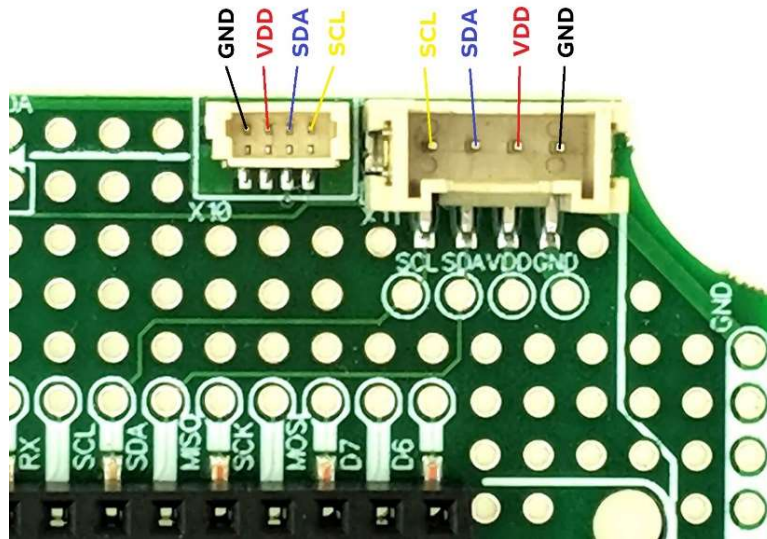

Pic.5. qBox AFC JST and Grove connectors pinout

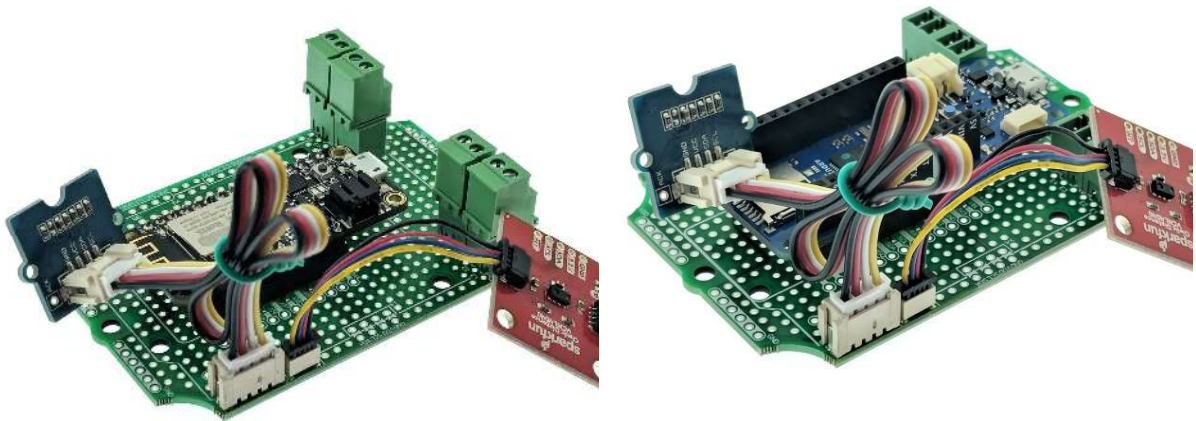

Pic.6. Grove and JST sensors board connection examples

PCB overview

IOT board connector pins have power and main interfaces names printed out on PCB. The rest of the pins have conditional names as Jxx.

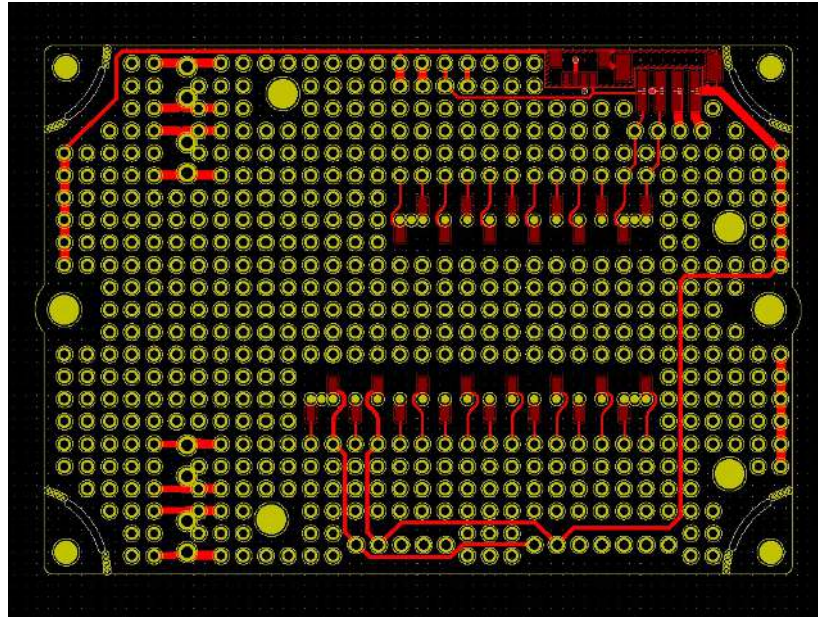

Pic.7. AFC PCB Front Copper traces

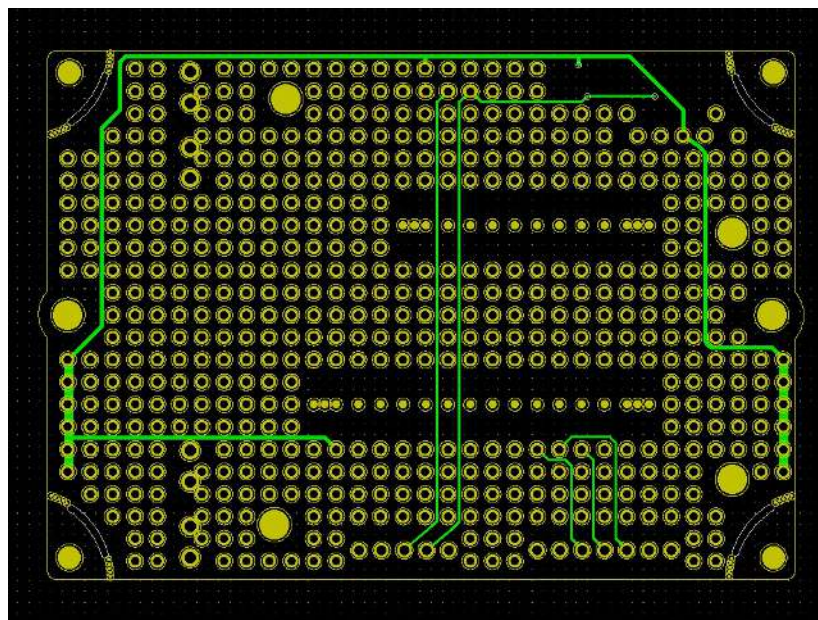

Pic.8. AFC PCB Back Copper traces

Low profile 0,1" pass through SMT connectors allow to carry Controller board as closer as possible to Kit PCB, saving space above that board to place additional components, like battery, OLED or sensors.

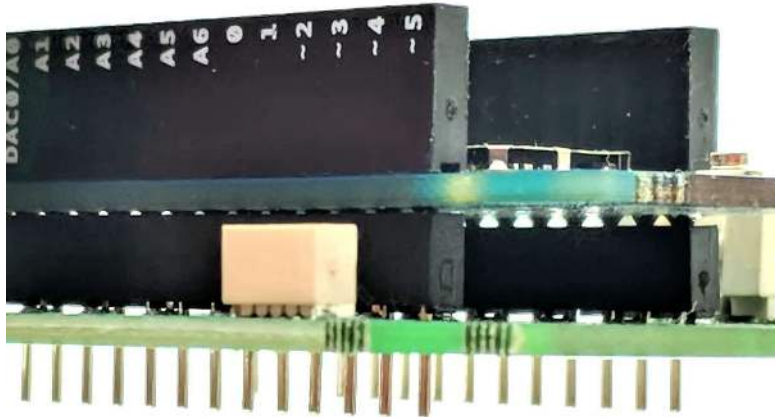

Pic.9. Low profile 0,1" pass through SMT connectors

Enclosure option

To use the device created with this PCB kit outdoor or just put an electronics developed in nice enclosure an extra option exists : the board of the PCB kit is developed to be used together with qBox collections enclosure.

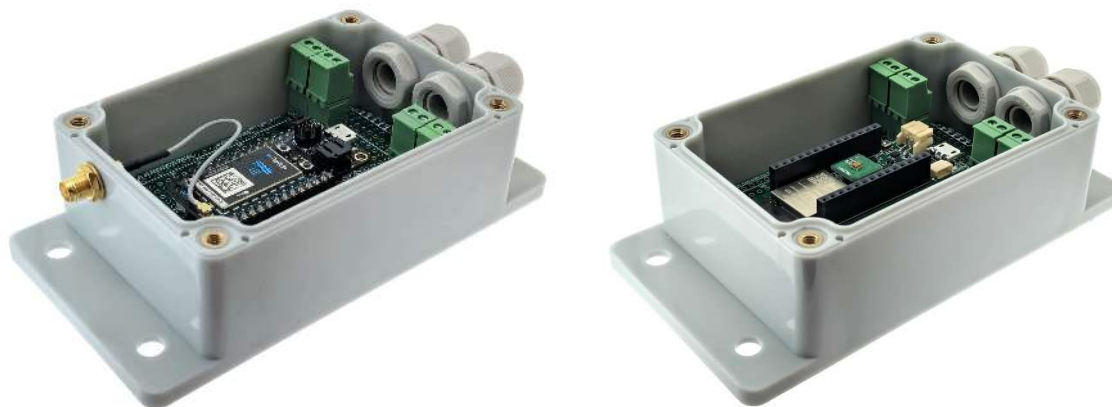

Pic.10. qBox collections enclosures to be used

To make it happens several simple steps to be done : just remove PCB corners by plier, mount PCB inside an enclosure and secure it by two 3,5mm self-tapping screws.

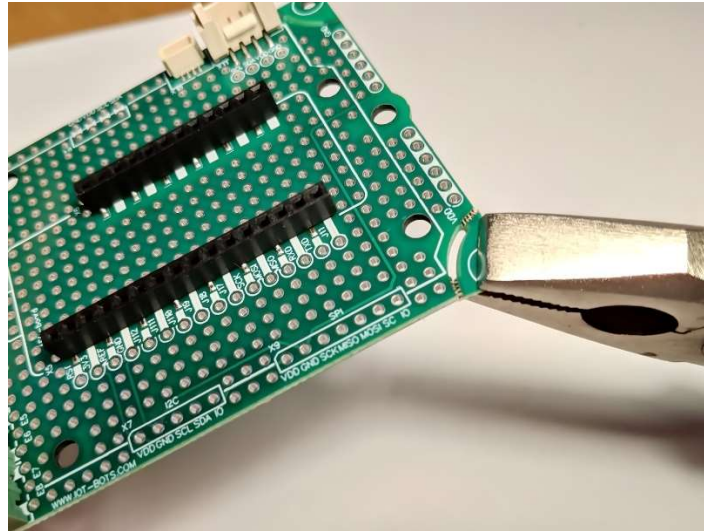

Pic.11. "Corners removal" PCB Enclosure option

Specification

PCB material grade: FR-4

PCB layers number: 2

PCB size: 3.43"x2.37"

Connectors installed:

- 1x12 pins low profile pass through 0,1" pitch AFC : 1
- 1x16 pins low profile pass through 0,1" pitch AFC : 1
- 4-pins 2mm pitch Grove I2C&Power : 1
- 4-pins 1mm pitch JST I2C&Power : 1
- 2-pins 3,5mm terminal block : 4

qGround AFC Enclosure Kit content

- High quality prototyping double sided PCB with connectors installed:
 - Adafruit Feather Compatible board female headers set (low profile pass through 0,1" pitch 1x12 and 1x16 pins connectors);
 - Four 2-pins 3,5mm terminal blocks;
 - One 4-pins Grove I2C&Power;
 - One 4-pin JST I2C&Power connector;

- Four 2-pins 3,5mm terminal plugs;
- Packaging bag and shipping box.

Usage examples

Using qGround AFC PCB Kits the variety of IOT DIY and POC and prototyping projects could be done.

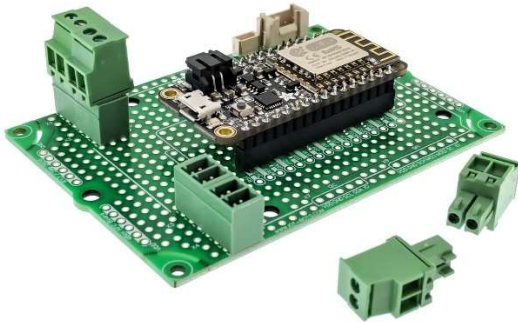

Pic. 12. WiFi ESP8266 project

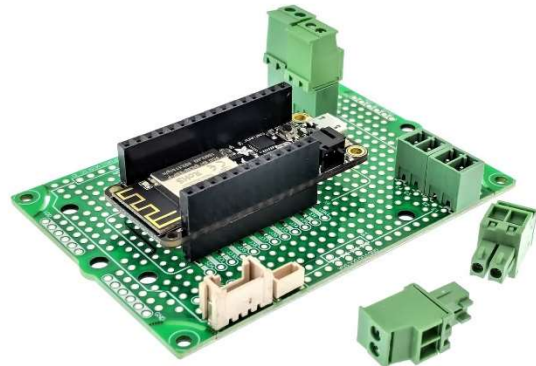

Pic. 13. WiFi ESP32 proto

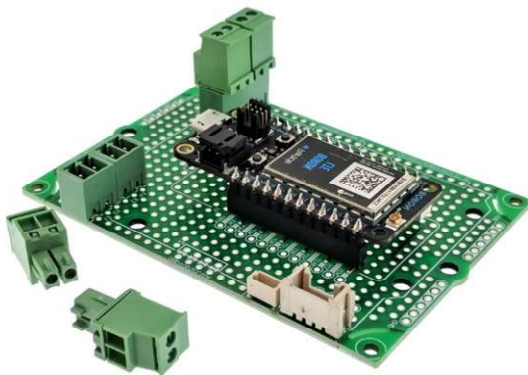

Pic. 14. LTE BT / BLE IOT POC



Pic. 15. qBoard light sensor controller

Abbreviations

NoNo	Abbreviation	Explanation
1	AFC	Adafruit Feather Compatible
2	AMC	Arduino MKR Compatible



Trademark notice

All referenced brands, product names, service names, and trademarks are the property of their respective owners.

Ordering info

NoNo	Item	SKU
1	qGround DIY IOT Adafruit Feather Compatible PCB Kit	IBT-QGX-AFC-B