

## IRIS-M

~25° medium beam with sublens and holder optimized for Luminus SST-50

### SPECIFICATION:

Dimensions	Ø 38.0 mm
Height	29.6 mm
Fastening	glue, pin
ROHS compliant	yes ⓘ

### MATERIALS:

Component	Type	Material	Colour	Finish
C10781_IRIS	Single lens	PMMA	clear	
C11534_IRIS-SST-HLD	Holder	PC	black	
C10333_LEDILSTAR-SUB	Sublens	PC		



### ORDERING INFORMATION:

#### Quantities for one set:

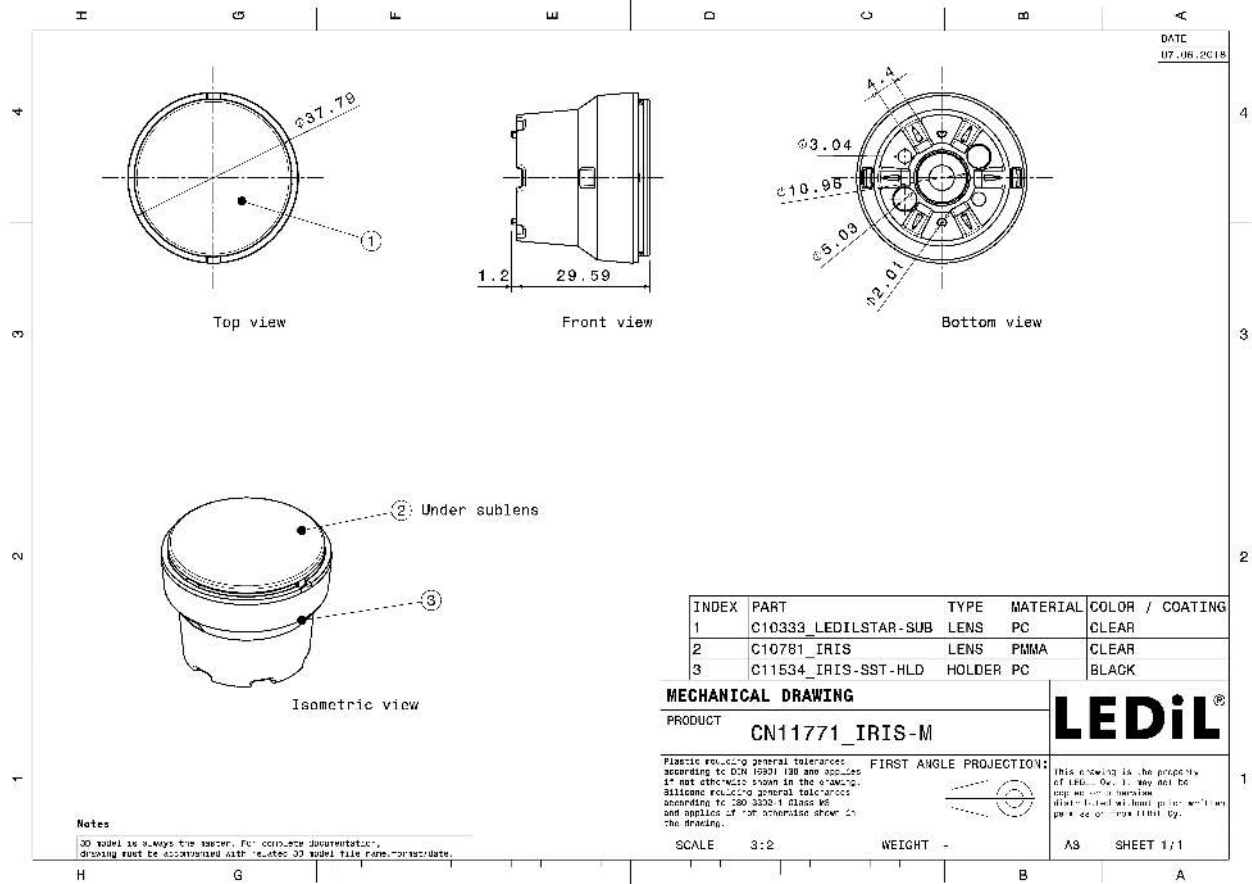

Single lens	1
Holder	1
Sublens	1

Component		Qty in box	MOQ	MPQ	Box weight (kg)
C10781_IRIS	Single lens	580	116	58	9.0
» Box size: 480 x 280 x 300 mm					
C11534_IRIS-SST-HLD	Holder	1044	116	29	6.8
» Box size: 480 x 280 x 300 mm					
C10333_LEDILSTAR-SUB	Sublens	2500	90	4	4.5
» Box size: 300 x 250 x 250 mm					

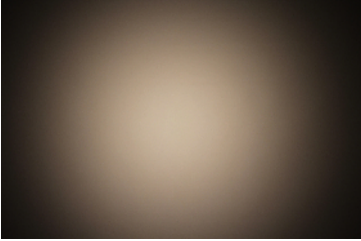
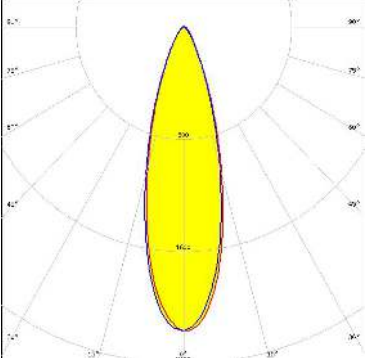

See also our general installation guide: [www.ledil.com/installation\\_guide](http://www.ledil.com/installation_guide)

### OPTICAL RESULTS (MEASURED):

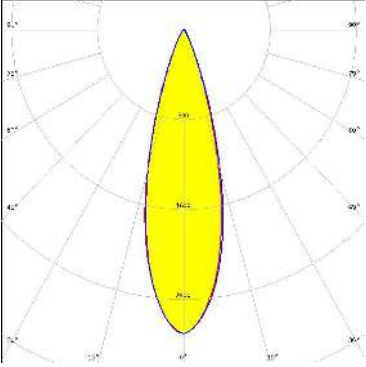
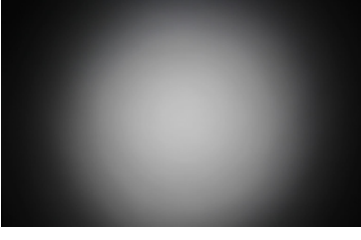
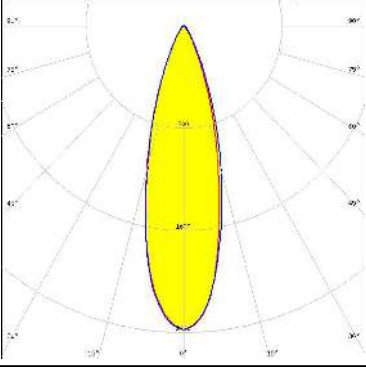
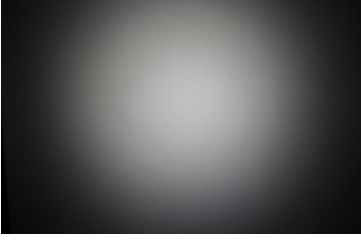
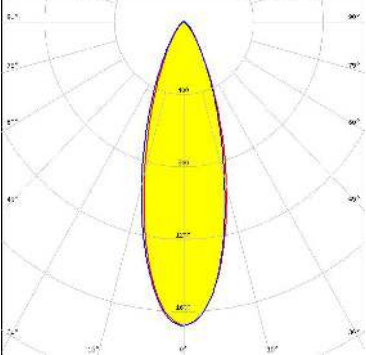
<p><b>CREE</b> ⇄ <b>LED</b></p> <p>LED MHD-E/G            FWHM / FWTM 30.0° / 59.0°            Efficiency 83 %            Peak intensity 2.2 cd/lm            LEDs/each optic 1            Light colour White            Required components:</p>		
<p><b>CREE</b> ⇄ <b>LED</b></p> <p>LED XHP35 HD            FWHM / FWTM 29.0° / 50.0°            Efficiency 79 %            Peak intensity 2.7 cd/lm            LEDs/each optic 1            Light colour White            Required components:</p>		
<p><b>CREE</b> ⇄ <b>LED</b></p> <p>LED XHP35 HI            FWHM / FWTM 29.0° / 56.0°            Efficiency 80 %            Peak intensity 2.4 cd/lm            LEDs/each optic 1            Light colour White            Required components:</p>		
<p><b>CREE</b> ⇄ <b>LED</b></p> <p>LED XHP50.2            FWHM / FWTM 32.0° / 65.0°            Efficiency 73 %            Peak intensity 1.7 cd/lm            LEDs/each optic 1            Light colour White            Required components:</p>		

### OPTICAL RESULTS (MEASURED):

#### CREE LED

LED XHP70  
 FWHM / FWTM 30.0° / 60.0°  
 Efficiency 83 %  
 Peak intensity 2.1 cd/lm  
 LEDs/each optic 1  
 Light colour White  
 Required components:

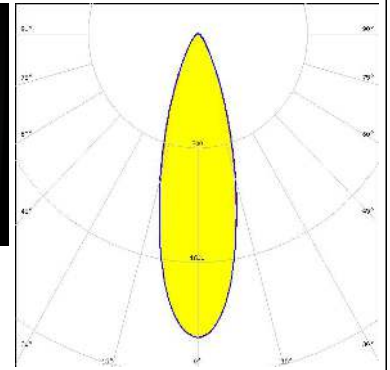
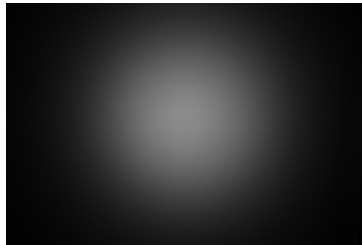

#### LUMINUS

LED SST-90  
 FWHM / FWTM 18.0° / 36.0°  
 Efficiency %  
 LEDs/each optic 1  
 Light colour White  
 Required components:

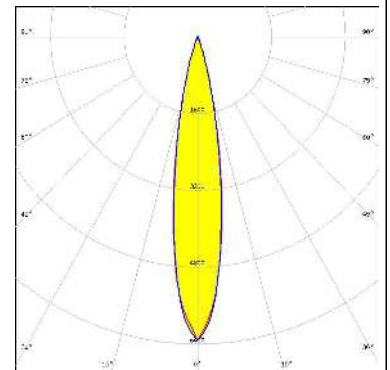

#### OSRAM Opto Semiconductors

LED Duris S10  
 FWHM / FWTM 29.0° / 54.0°  
 Efficiency 78 %  
 Peak intensity 2.7 cd/lm  
 LEDs/each optic 1  
 Light colour White  
 Required components:

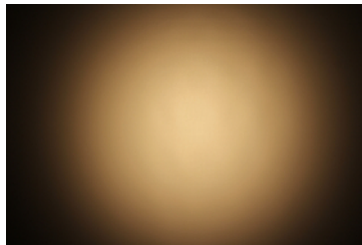





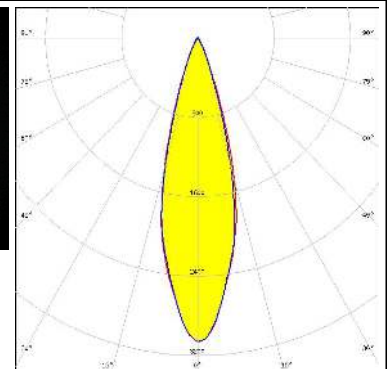
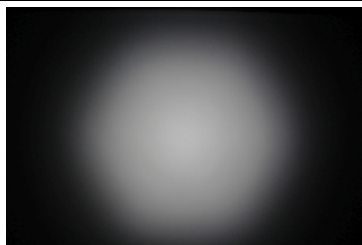

#### OSRAM Opto Semiconductors

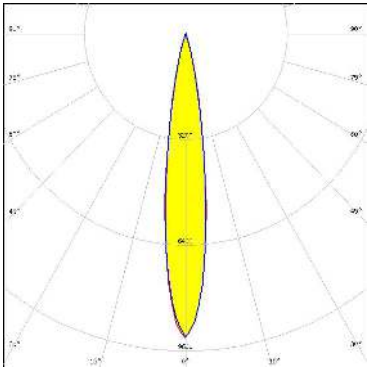
LED OSLON Square CSSRM2/CSSRM3  
 FWHM / FWTM 29.0° / 47.0°  
 Efficiency 79 %  
 Peak intensity 3.1 cd/lm  
 LEDs/each optic 1  
 Light colour White  
 Required components:

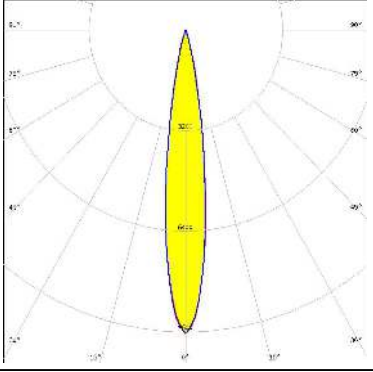

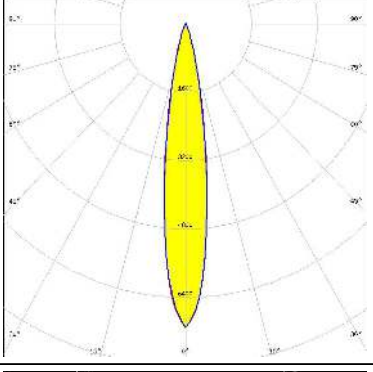
### OPTICAL RESULTS (SIMULATED):

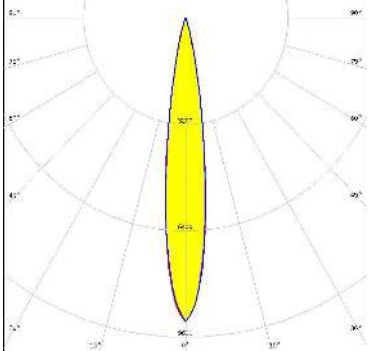
	<p>LED J Series 5050B 6V K Class            FWHM / FWTM 16.0° / 30.0°            Efficiency 85 %            Peak intensity 9.2 cd/lm            LEDs/each optic 1            Light colour White            Required components:</p>	
	<p>LED J Series 5050C 6V E Class            FWHM / FWTM 16.0° / 28.0°            Efficiency 85 %            Peak intensity 9.7 cd/lm            LEDs/each optic 1            Light colour White            Required components:</p>	
	<p>LED XHP35.2 HD            FWHM / FWTM 16.0° / 33.0°            Efficiency 82 %            Peak intensity 7.1 cd/lm            LEDs/each optic 1            Light colour White            Required components:</p>	
	<p>LED XHP50.3 HD            FWHM / FWTM 16.0° / 29.0°            Efficiency 83 %            Peak intensity 9.1 cd/lm            LEDs/each optic 1            Light colour White            Required components:</p>	

### OPTICAL RESULTS (SIMULATED):



LED	XHP70.2
FWHM / FWTM	30.7° / 60.6°
Efficiency	80 %
Peak intensity	2.1 cd/lm
LEDs/each optic	1
Light colour	White
Required components:	

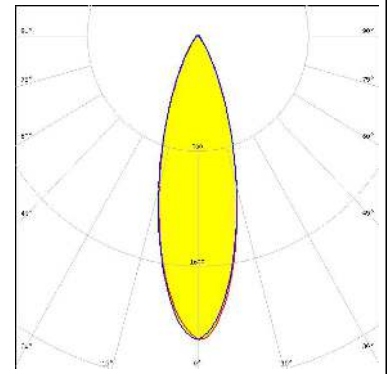

### GENERAL INFORMATION:

NOTE: The typical beam angle will be changed by different color, chip size and chip position tolerance. The typical total beam angle is the full angle measured where the luminous intensity is half of the peak value.

### MATERIALS:

As part of our continuous research and improvement processes, and to ensure the best possible quality and availability of our products, LEDiL reserves the right to change material grades without notice.

### PRODUCT DATA USER AGREEMENT AND DISCLAIMER:

The measured data in the provided downloadable LEDiL Product Datasheets and Mechanical 2D-Drawings is rounded and provided as reference for planning. LEDiL Oy's optical specifications have been verified by conducting performance testing of the products in accordance with the company's quality system. The reported data are averaged results of multiple measurements with typical variation. LEDiL Oy reserves the right to without prior notification make changes and improvements to its products.

LEDiL Oy assumes neither warranty, nor guarantee nor any other liability of any kind for the contents and correctness of the provided data. The provided data has been generated with highest diligence but the provided data may in reality not represent the complete possible variation range of all intrinsic parameters. Therefore, in certain cases a deviation from the provided data could occur.

LEDiL Oy reserves the right to undertake technical changes of its products without further notification which could lead to changes in the provided data. LEDiL Oy assumes no liability of any kind for the possible deviation from any provided data or any other damage resulting from the usage of the provided data.

The user agrees to this disclaimer and user agreement with the download or usage of the provided files.

#### LEDiL Oy

Joensuunkatu 13  
FI-24240 SALO  
Finland

#### LEDiL Inc.

228 West Page Street  
Suite D  
Sycamore IL 60178  
USA

#### Ledil Optics Technology (Shenzhen) Co., Ltd.

# 405 , Block B  
Casic Motor Building  
Shenzhen 518057  
P.R.CHINA

#### Local sales and technical support

[www.ledil.com/  
where\\_to\\_buy](http://www.ledil.com/where_to_buy)

#### Shipping locations

Salo, Finland  
Hong Kong, China

#### Distribution Partners

[www.ledil.com/  
where\\_to\\_buy](http://www.ledil.com/where_to_buy)