

Click to  
**ORDER**  
samples

**AMEL45-JZ**



Encapsulated

The new AMEL45-JZ is an AC/DC converter that offers much greater cost effectiveness due to material normalization and production automation also leading to improved reliability and performance. Offering a commercial input voltage range of 85-264VAC and an output voltage range from 5-48V, this series will offer many benefits to your new system design.

This new series offers great operating temperatures, from -40°C to 70°C also features an isolation of 4000VAC for improved reliability and system safety. Furthermore, a high MTBF of 300,000h, output short circuit protection (OSCP), output over-current protection (OCP) and an output over-voltage protection (OVP) come standard with the series.

The AMEL45-JZ is perfect for street lighting controls, grid power, LED, instrumentation, industrial controls, communication and civil applications.

**Features**

- Universal Input: 85 - 264VAC/100 - 370VDC
- Operating Temp: -40 °C to +70 °C
- High isolation voltage: 4000VAC
- Low ripple & noise, 120mV(p-p), Max.
- Output short circuit, over-current, over-voltage protection
- Regulated Output

**Summary**

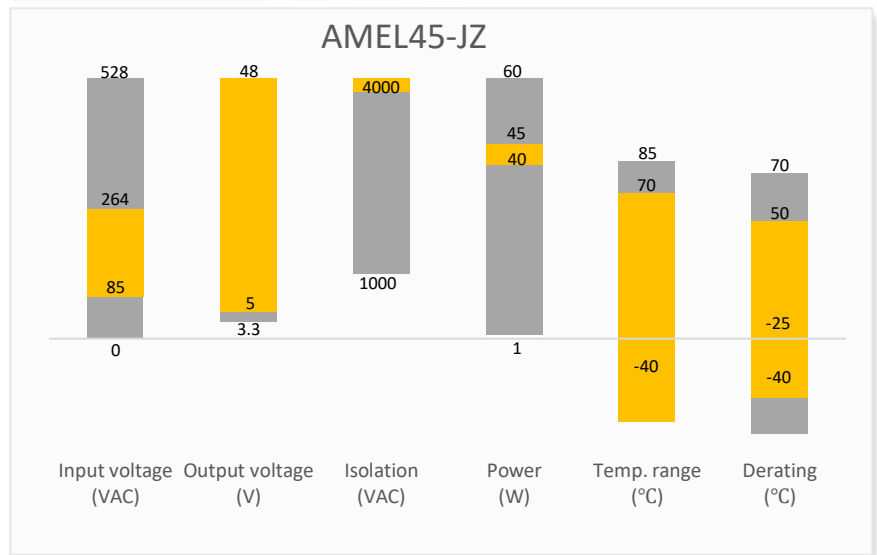

**Training**



Product Training Video  
(click to open)

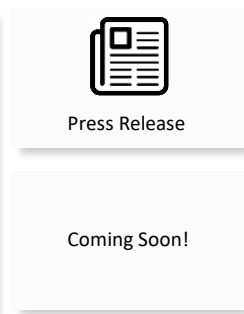

Application Notes

**Applications**



Power Grid



Industrial



Telecom



Instrumentation

## Models & Specifications

Single Output							
Model	Input Voltage (VAC/Hz)	Input Voltage (VDC)	Max Output wattage (W)	Output Voltage (V)	Output Current max (A)	Maximum capacitive load ( $\mu$ F)	Efficiency @ 230VAC (%)
AMEL45-5SJZ	85-264/47-63	100-370	40	5	8	30000	81
AMEL45-12SJZ	85-264/47-63	100-370	45	12	3.8	6400	84
AMEL45-15SJZ	85-264/47-63	100-370	45	15	3	5600	85
AMEL45-24SJZ	85-264/47-63	100-370	45	24	1.9	2000	86
AMEL45-48SJZ	85-264/47-63	100-370	45	48	0.94	600	87

Note: Use suffix "ST" for chassis and suffix "STD" for DIN-Rail mounting (ex. AMEL45-5SJZ-ST is chassis mounting and AMEL45-5SJZ-STD is DIN-Rail mounting version).

Input Specifications				
Parameters	Conditions	Typical	Maximum	Units
Current	115VAC		1.5	A
	230VAC		0.75	A
Inrush current	115VAC	50		A
	230VAC	70		A
External fuse	slow blow type,250V	3.15		A

Output Specifications				
Parameters	Conditions	Typical	Maximum	Units
Voltage accuracy	Full load	$\pm$ 2		%
Line regulation	Full load	$\pm$ 0.5		%
Load regulation	0-100% load	$\pm$ 1		%
Ripple & Noise*	20MHz bandwidth	60	120	mV p-p
Hold up time	115VAC	8		ms
	230VAC	50		ms

\* Ripple and Noise are measured at 20MHz bandwidth by using the referenced Application circuit.

Isolation Specifications				
Parameters	Conditions	Typical	Rated	Units
Tested I/O voltage	60 sec, leakage current < 5mA		4000	VAC

General Specifications				
Parameters	Conditions	Typical	Maximum	Units
Safety class	Class II			
Over Current protection	Auto recovery	$\geq$ 110		% of Iout
Over voltage protection	5V Vout, Voltage clamp or hiccup		9	VDC
	12V Vout, Voltage clamp or hiccup		16	VDC

	15V Vout, Voltage clamp or hiccup		24	VDC
	24V Vout, Voltage clamp or hiccup		35	
	48V Vout, Voltage clamp or hiccup		56	VDC
Short circuit protection	Hiccup, Continuous, Auto recovery			
Operating temperature	See derating graph	-40 to +70		°C
Storage temperature		-40 to +85		°C
Lead temperature	Wave soldering	260 ± 5 °C; Maximum duration 5 - 10s		
	Hand soldering	360 ± 10 °C; Maximum duration 3 - 5s		
No-load power consumption			0.5	W
Power derating	-40 °C ~ -25 °C, 85VAC ~ 220VAC	4		% / °C
	-40 °C ~ -25 °C, 220VAC ~ 264VAC	0		% / °C
	50 °C ~ 70 °C	2.5		% / °C
	85VAC ~ 100VAC	1.33		% / VAC
	240VAC ~ 264VAC	1.25		% / VAC
Temperature coefficient		±0.02		% / °C
Cooling	Free air convection			
Humidity	Non-condensing		95	% RH
Case material	Heat resistant black Plastic (flammability to UL 94V-0)			
Weight	PCB mountable models		205	g
Dimensions (L x W x H)	PCB mountable models	3.43 x 2.05 x 1.16 inches (87.0 x 52.0 x 29.5mm)		
MTBF	> 300 000 hrs (MIL-HDBK -217F, t=+25°C)/Full Load			
NOTE: All specifications in this datasheet are measured at an ambient temperature of 25°C, humidity<75%, nominal input voltage and at rated output load unless otherwise specified.				

Safety Specifications		
Parameters		
Agency approval	UL 62368-1	
Standards	Design to meet IEC/EN 62368	
	EMC - Conducted and radiated emission	CISPR32 / EN55032, class B
	Electrostatic Discharge Immunity	IEC 61000-4-2 Contact ±6KV / Air ±8KV, Criteria B
	RF, Electromagnetic Field Immunity	IEC 61000-4-3 10V/m, Criteria A
	Electrical Fast Transient/Burst Immunity	IEC 61000-4-4 ±4KV, Criteria B
	Surge Immunity	IEC 61000-4-5 L-L ±1KV, Criteria B IEC 61000-4-5 L-L ±2KV / L-G ±4KV, with EMC recommended circuit, Criteria B
	RF, Conducted Disturbance Immunity	IEC 61000-4-6 10Vr.m.s, Criteria A
	Voltage dips, Short Interruptions Immunity	IEC 61000-4-11 0%, 70%, Criteria B

## Derating

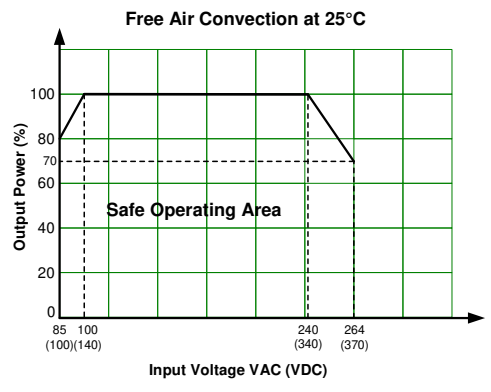
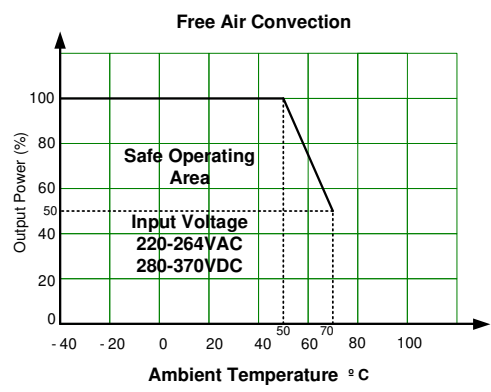
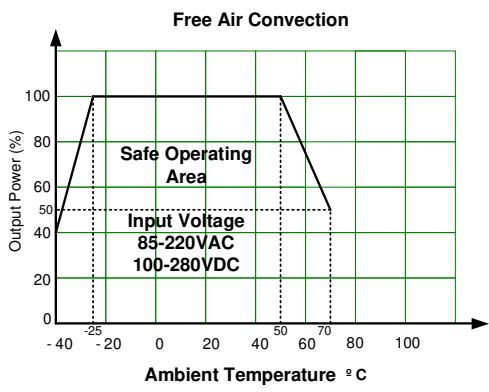

## Typical Application Circuit

Single Output

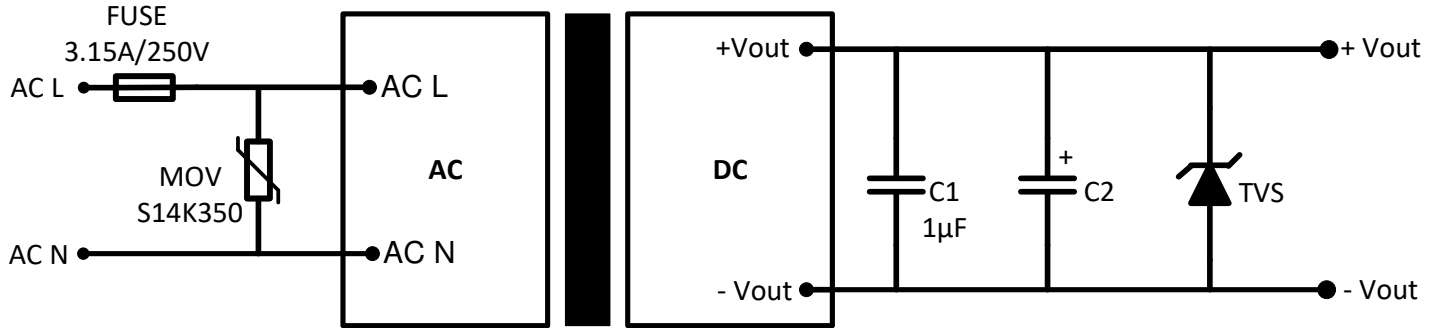

Model	C2	TVS
5 Vout	680 µF	SMBJ7.0A
12 / 15 Vout	220 µF	SMBJ20A
24 Vout	120 µF	SMBJ30A
48 Vout	100 µF	SMBJ64A

Note: Choose capacitors with at least 20% voltage margin.

## EMC Recommended Circuit

Single Output

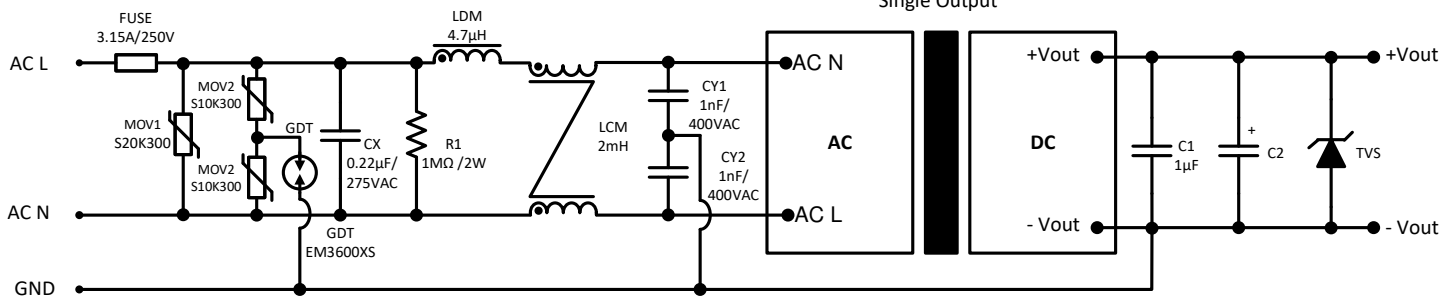

## Dimensions

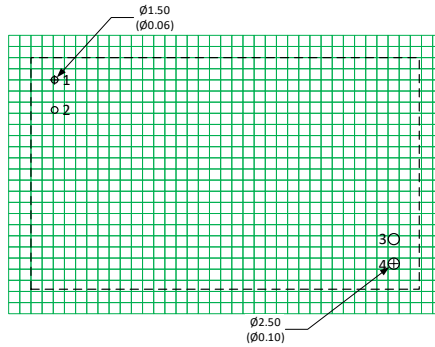
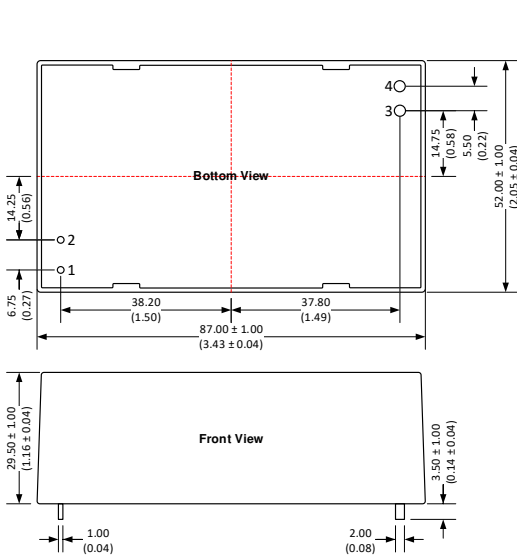

Note : Grid 2.54\*2.54 mm

Notes:  
 All dimensions are typical in millimeters (inches).  
 Pin diameter tolerances :  $\pm 0.10$  ( $\pm 0.004$ )  
 General tolerance :  $\pm 0.50$  ( $\pm 0.02$ )

### Pin Output Specifications

Pin	Single
1	AC Input (L)
2	AC Input (N)
3	-V Output
4	+V Output

## Dimensions with ST Optional

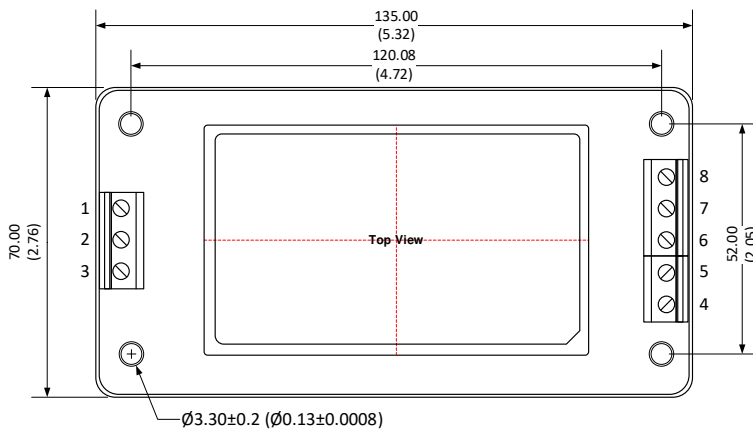

### Pin Output Specifications

Pin	Single
1	AC Input (L)
2	NC
3	AC Input (N)
4	+V Output
5	-V Output
6	NC
7	NC
8	NC

Note:  
 Unit: mm(inch)  
 Wire range : 24-12 AWG  
 Tightening torque : Max 0.4 N.m  
 General tolerance  $\pm 1.00$  : ( $\pm 0.04$ )

## Dimensions with STD Optional

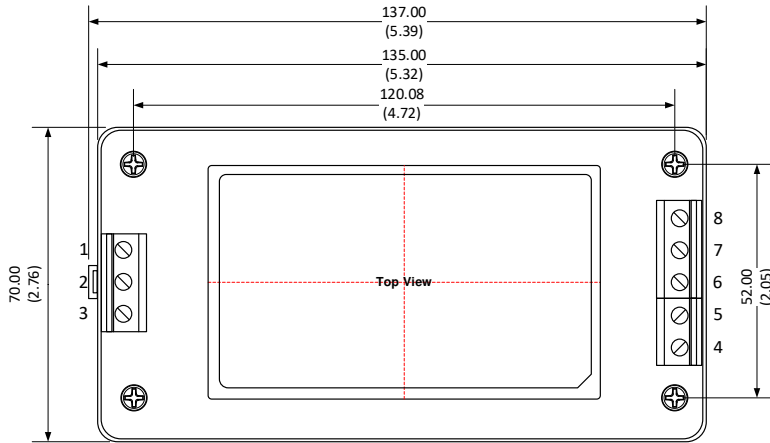

Pin Output Specifications	
Pin	Single
1	AC Input (L)
2	NC
3	AC Input (N)
4	+V Output
5	-V Output
6	NC
7	NC
8	NC

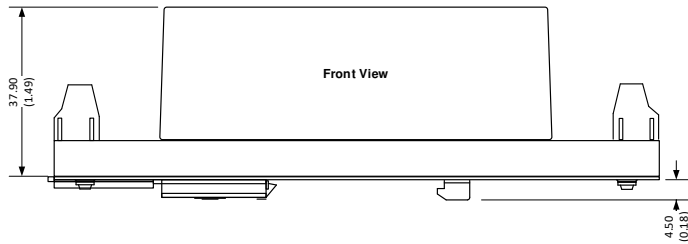

Note:  
Unit: mm(inch)  
Wire range : 24-12 AWG  
Mounting rail: TS35  
Tightening torque : Max 0.4 N.m  
General tolerance  $\pm 1.00$  : ( $\pm 0.04$ )  
Mounting rail must be grounded.

**NOTE:** **1.** Datasheets are updated as needed and as such, specifications are subject to change without notice. Once printed or downloaded, datasheets are no longer controlled by Aimtec; refer to [www.aimtec.com](http://www.aimtec.com) for the most current product specifications. **2.** Product labels shown, including safety agency certifications on labels, may vary based on the date manufactured. **3.** Mechanical drawings and specifications are for reference only. **4.** All specifications are measured at an ambient temperature of 25°C, humidity<75%, nominal input voltage and at rated output load unless otherwise specified. **5.** Aimtec may not have conducted destructive testing or chemical analysis on all internal components and chemicals at the time of publishing this document. CAS numbers and other limited information are considered proprietary and may not be available for release. **6.** This product is not designed for use in critical life support systems, equipment used in hazardous environments, nuclear control systems or other such applications which necessitate specific safety and regulatory standards other the ones listed in this datasheet. **7.** Warranty is in accordance with Aimtec's standard Terms of Sale available at [www.aimtec.com](http://www.aimtec.com).