

Advantiv EVAL-ADV7612-7511 Video Evaluation Board

FEATURES

- 2 HDMI inputs, 1 HDMI output
- PC communication via RS-232 or USB interface
- Jumperable signal paths for audio and video (jumpers can be removed and signals connected in a different manner)

EQUIPMENT NEEDED

- Computer with RS-232 (or USB) I/O to accomplish the following:
 - Send scripts to the board's command line interface
 - Send commands to the board's repeater software and view software output
 - Control the board via Advantiv video evaluation software (AVES) application
 - Update the board's firmware (if desired or necessary)

SOFTWARE NEEDED

- Windows OS for controlling the board via AVES application
- RS-232 software for updating the board firmware (if desired or necessary)

GENERAL DESCRIPTION

The Advantiv® EVAL-ADV7612-7511 video evaluation board (AVEB) is a low cost solution for evaluating the performance of the [ADV7612](#) HDMI receiver and/or the ADV7511 HDMI transmitter.

The evaluation board provides a Blackfin® [ADSP-BF524](#) processor for system control. The [ADSP-BF524](#) offers the potential to process audio (no audio software is included). The evaluation board includes software (firmware) that provides a serial command interface to control the board's functionality.

This evaluation board is available in two options.

- With HDCP support (EVAL-ADV7612-7511), available only to licensees of HDCP
- Without HDCP support (EVAL-ADV7612-7511P)

PHOTOGRAPH OF EVALUATION BOARD

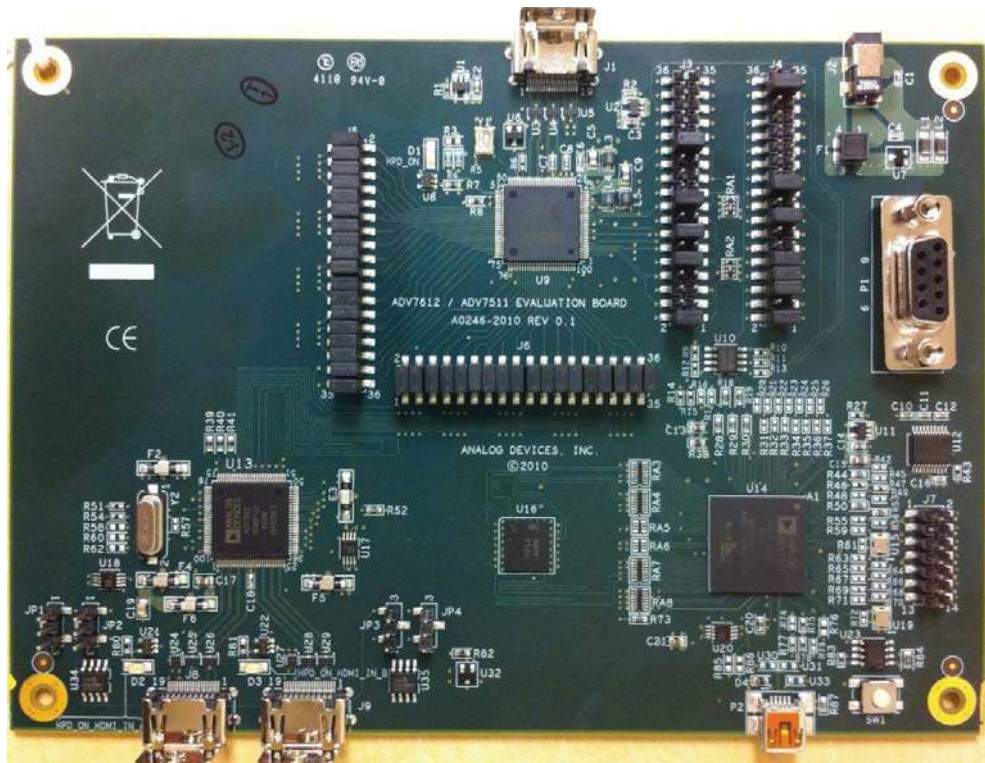

Figure 1. Advantiv EVAL-ADV7612-7511 Video Evaluation Board with Factory Jumper Settings

TABLE OF CONTENTS

Features	1	Terminology	4
Equipment Needed.....	1	Evaluation Board Hardware.....	5
Software Needed	1	Evaluation Board Usage.....	5
General Description	1	Jumpers	6
Photograph of Evaluation Board	1	Evaluation Board Software.....	7
Revision History	2	Upgrading the Firmware	7
Evaluation Board Artwork and Components	3	Related Links.....	8

REVISION HISTORY

7/11—Revision 0: Initial Version

EVALUATION BOARD ARTWORK AND COMPONENTS

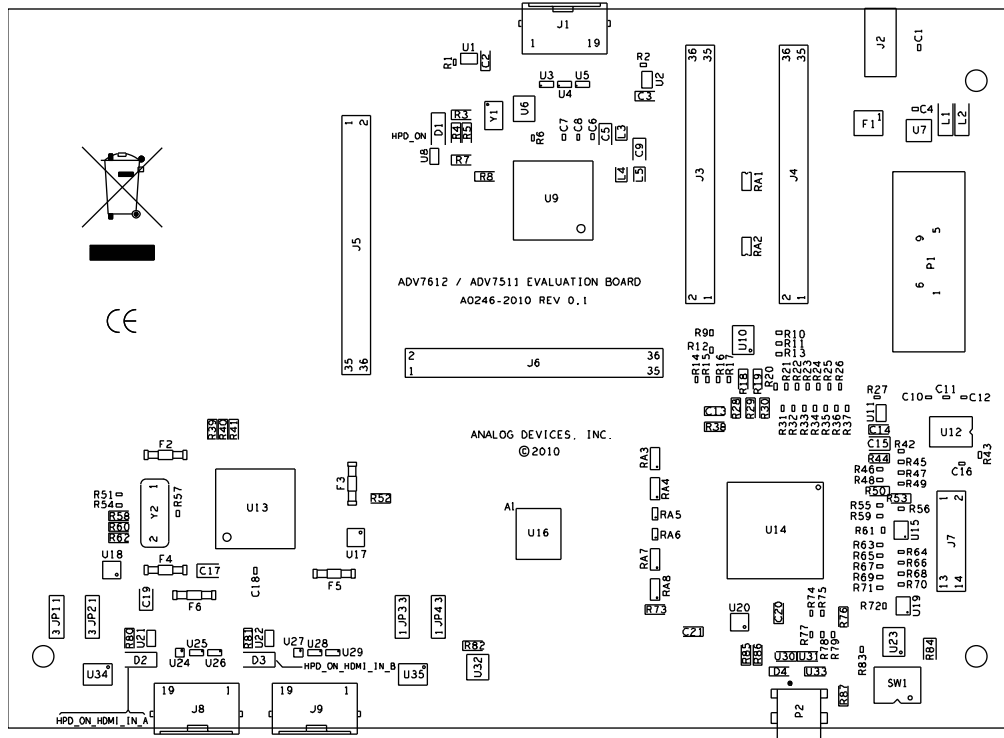

Figure 2. Assembly Drawing (Top Side) of the EVAL-ADV7612-7511

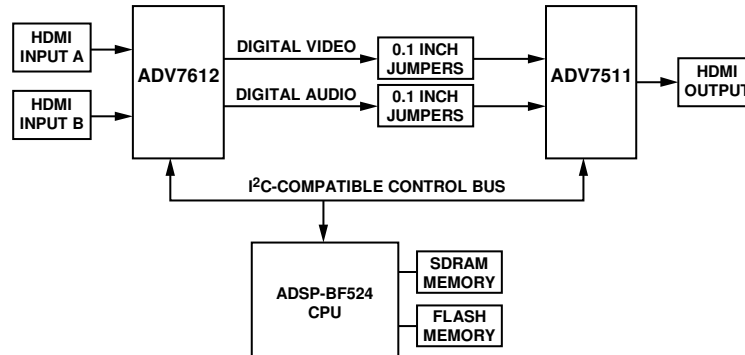

Figure 3. Block Diagram of the EVAL-ADV7612-7511

Table 1. Evaluation Board Hardware Components

Reference Designator	Function	Description
J8, J9	HDMI inputs	J8 is HDMI Port A; J9 is HDMI Port B.
J1	HDMI output	This is the only video output connector.
P1	RS-232 port	RS-232 interface to the computer (for user control and debug output).
P2	USB port	This USB port can be used instead of RS-232 if the user's computer does not have the RS-232 interface.
SW1	Reset	This switch resets the BF524 processor.
J2	Power	J1 is where the 5 V, 2.5 A power supply is connected.
J7	BF524 JTAG	The ICE-100B or the HPUSB-ICE is connected here to reprogram the system flash or to execute source code debugging.
JP1, JP2	Port A EDID	These jumpers (see Figure 2, lower left) connect the I ² C bus from the Blackfin processor to the EDID EEPROM.
JP3, JP4	Port B EDID	These jumpers (see Figure 2, bottom middle) connect the I ² C bus from the Blackfin processor to the EDID EEPROM.
J3, J4	Audio/control jumpers	The audio bus can be jumpered among three configurations on these connectors. They also have several control signals available for probing, as well as video syncs and clock.
J5, J6	Video jumpers	The digital video pixel bus signals are jumpered here for easy access and flexibility in evaluation.

TERMINOLOGY

Throughout this user guide, the following terms are used.

Source

A source outputs digital audio/video over a DVI/HDMI interface. This can be a DVD/Blu-ray player, set-top box, game console, or any other device with a DVI/HDMI output.

Sink

A sink accepts video through a DVI/HDMI interface. This is nearly always a display with DVI/HDMI input in the context of this user guide.

Repeater

A repeater refers to the software that runs on the [ADSP-BF524](#) and implements the link between a source and sink with respect to this evaluation board.

EVALUATION BOARD HARDWARE

EVALUATION BOARD USAGE

The evaluation board can be connected in the ways shown in Figure 3. By default, the video buses of the [ADV7612](#) and [ADV7511](#) are directly connected, and the I²S and S/PDIF outputs of the [ADV7612](#) are directly connected to the I²S and S/PDIF inputs of the [ADV7511](#).

Note that the version of the board without HDCP support (EVAL-ADV7612-7511P) does not work with most consumer HDMI sources (for example, Blu-ray players) because they automatically implement HDCP encryption. Therefore, a non-HDCP video source is needed with the non-HDCP version of the board.

An HDCP license is required to purchase an HDCP-enabled board. No license is required to purchase the non-HDCP-enabled board.

The RS-232 command-line interface operates at 115,200 baud, eight data bits, no parity, one stop bit, and no flow control. Typing **help** via RS-232 lists the commands that can be used to control the board as well as indicate the version of firmware and build date.

If the board is HDCP-enabled, the Analog Devices, Inc., repeater software starts on power-up, allowing an HDMI sink to receive content from an HDMI/HDCP source soon after it is connected.

There are three main ways to control the board.

- Commands via RS-232
- Repeater software via RS-232
- Advantiv video evaluation software (AVES)

Commands via RS-232

This mode uses the RS-232 command-line interface. The [ADSP-BF524](#) powers up to a known reset state and then outputs a prompt. At this point, commands can be entered. Typing **help** prints a list of commands. Using the appropriate commands, the user can read/write registers in the [ADV7612](#) and [ADV7511](#). All registers are at their reset values.

Boards without HDCP enabled (EVAL-ADV7612-7511P) typically use this mode.

It is possible to start the repeater software in this mode with the `startrep` command via RS-232. This only works with HDCP-protected sources on an HDCP-enabled board. A non-HDCP-enabled board can still operate but does not support HDCP.

Repeater Software via RS-232

This mode also offers the RS-232 command-line interface but primarily to control the repeater software. Boards with HDCP support (EVAL-ADV7612-7511) typically start the repeater software on power-up. The repeater software outputs messages via RS-232 as it establishes an encrypted HDMI link and sources, sinks, or formats change. Registers can still be read/written from the command line, but anything that is written to a register can be overwritten by the repeater software.

In this mode, there are additional commands from the repeater itself. All repeater commands are in the `rep XXX` format, where XXX is the repeater command. A list of repeater commands is displayed using the `rep help` command. These commands provide information about the state of the repeater, source, and sink.

AVES

AVES is a Windows®-based application that runs on a PC and allows the user to read/write registers on the [ADV7612](#) and [ADV7511](#). It also displays the individual bit fields for each register and allows the user to modify these individual bit fields. The software supports RS-232, USB, and I²C (using the Total Phase Aardvark I²C/SPI host adapter). Information about the video evaluation board can be found on the EVAL-ADV7612-7511 page on EngineerZone at <http://ez.analog.com/docs/DOC-1713>.

For a non-HDCP-enabled board, this software may be the easiest way to evaluate the different modes of the [ADV7612](#) and [ADV7511](#).

Additional information about the software can be found on EngineerZone at <http://ez.analog.com/docs/DOC-1789>, where the latest version of the software can also be downloaded.

JUMPERS

This evaluation board has all of the digital audio/video signals (as well as some control signals) connected to 0.1 inch jumpers. This provides users with easy access and maximum flexibility when evaluating the devices.

The arrangement of the pins/signals in the schematic does not necessarily match the physical arrangement on the board.

Figure 4 to Figure 7 match the physical arrangement on the board and may be useful when probing these signals.

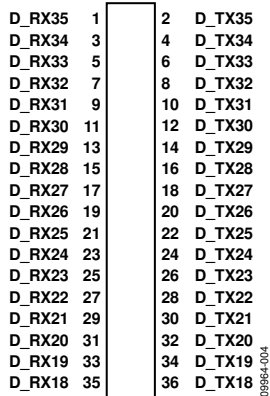

Figure 4. J5 Configuration

Factory (Default) Setting Is for Jumpers Installed on All Odd/Even Pairs

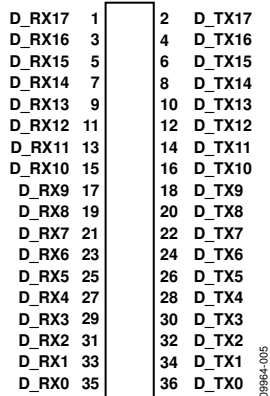

Figure 5. J6 Configuration

Factory (Default) Setting Is for Jumpers Installed on All Odd/Even Pairs

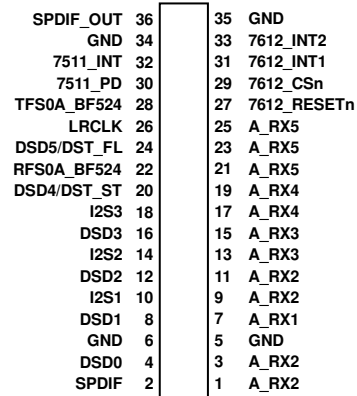

Figure 6. J3 Configuration

Factory (Default) Setting Is for Jumpers Installed on the Following Pairs:
1 to 2, 9 to 10, 13 to 14, 17 to 18, 25 to 26

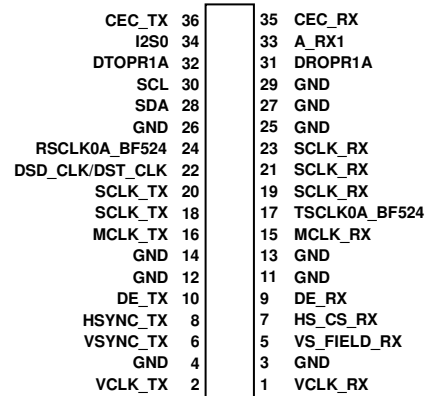

Figure 7. J4 Configuration

Factory (Default) Setting Is for Jumpers Installed on the Following Pairs:
1 to 2, 5 to 6, 7 to 8, 9 to 10, 15 to 16, 19 to 20, 33 to 34

EVALUATION BOARD SOFTWARE

UPGRADING THE FIRMWARE

The software (firmware) on the evaluation board can be upgraded using the standard Blackfin development tools.

- VisualDSP++ 5.0 Update 8
- JTAG debugger for Blackfin processors (HPUSB-ICE or ICE-100B) connected to the JTAG connector (J7)

Using these tools, you can connect to the [ADSP-BF524](#) processor, run a script, and program the SPI flash memory device (U10).

With that said, all but a very few evaluation boards are shipped with the U-Boot boot loader firmware. If this is the case, you have the option of upgrading the firmware using only an RS-232 cable and software.

If you see the following output after resetting the board or applying power, your evaluation board has U-Boot:

```
-----
U-Boot 2010.06 (ADI-2010R1-RC2) (Jan 12 2011 -
15:53:34)

CPU:   ADSP bf524-0.2 (Detected Rev: 0.2) (spi
flash boot)
Board: ADI Advantiv™ Video Evaluation Board
       Support: http://ez.analog.com
Clock: VCO: 300 MHz, Core: 300 MHz, System: 100
MHz
RAM:   8 MiB
SF: Detected M25P80 with page size 256, total 1
MiB
In:    serial
Out:   serial
Err:   serial
KGDB: [on serial] ready
Hit any key to stop autoboot:
-----
```

If your evaluation board has U-Boot, you can use the following steps to upgrade the application firmware of your board (if you determine this is necessary). Note that these instructions assume you are using the latest version of Tera Term for Windows (which is free to download and use), but any RS-232 software with Ymodem upload capability should also work.

1. After you see the **hit any key to stop autoboot** prompt, press a key during the countdown. You should then see a prompt, **bfin >**.
2. At the prompt, type the following command:

```
sf probe 0:1
```

You should see the following:

```
SF: Detected M25P80 with page size 256, total
1 MiB
1024 KiB M25P80 at 0:1 is now current device
bfin>
```

3. At the prompt, type the following command:

```
loady
```

You should see the following output:

```
## Ready for binary (ymodem) download to
0x00100000 at 115200 bps...
C
```

4. In Tera Term, under **File**, click **Transfer**, then **YMODEM**, and select **Send...**
5. Select the application firmware (for example, **EVAL-ADV7612-7511_v1p3_app.bin**) and click **Open**.
6. You should see the YMODEM send dialog box progress quickly from 0% to 100%. If the software stalls at Packet 1 or Packet 2 for a few seconds, you may need to cancel and retry. It is possible that you may need to repeat Step 3 through Step 5 a few times to accomplish the transfer. After the transfer is complete, you should see the following:

```
CCxyzModem - CRC mode,
0 (SOH) / 215 (STX) / 0 (CAN) packets, 5 retries
## Total Size      = 0x000357fc = 219132
Bytes
bfin>
```

7. At the prompt, type the following command to erase the application area of the SPI flash memory:

```
sf erase 0x60000 0xa0000
```

You should then see the following output:

```
bfin>
```

8. At the prompt, type the following command to program the application area of the SPI flash memory:

```
sf write $(loadaddr) 0x60000 $(filesize)
```

You should then see the following output:

```
bfin>
```

9. At this point, if you reset your board and allow the countdown to complete, U-Boot should launch the application firmware that you just programmed.

RELATED LINKS

Resource	Description
ADV7612	Product Page, ADV7612 Dual Port Xpressview™ 225 MHz HDMI® Receiver
ADV7511	Product Page, ADV7511 225 MHz, High Performance HDMI® Transmitter with ARC
ADSP-BF524	Product Page, ADSP-BF524 Low Power Blackfin Processor with Advanced Peripherals and Low Standby Power
DOC-1751	ADV7612 Design Support Files
DOC-1740	ADV7511 Design Support Files
DOC-1713	Advantiv™ EVAL-ADV7612-7511 Video Evaluation Board
DOC-1789	Advantiv™ Video Evaluation Software

I²C refers to a communications protocol originally developed by Philips Semiconductors (now NXP Semiconductors).

**ESD Caution**

ESD (electrostatic discharge) sensitive device. Charged devices and circuit boards can discharge without detection. Although this product features patented or proprietary protection circuitry, damage may occur on devices subjected to high energy ESD. Therefore, proper ESD precautions should be taken to avoid performance degradation or loss of functionality.

Legal Terms and Conditions

By using the evaluation board discussed herein (together with any tools, components documentation or support materials, the "Evaluation Board"), you are agreeing to be bound by the terms and conditions set forth below ("Agreement") unless you have purchased the Evaluation Board, in which case the Analog Devices Standard Terms and Conditions of Sale shall govern. Do not use the Evaluation Board until you have read and agreed to the Agreement. Your use of the Evaluation Board shall signify your acceptance of the Agreement. This Agreement is made by and between you ("Customer") and Analog Devices, Inc. ("ADI"), with its principal place of business at One Technology Way, Norwood, MA 02062, USA. Subject to the terms and conditions of the Agreement, ADI hereby grants to Customer a free, limited, personal, temporary, non-exclusive, non-sublicensable, non-transferable license to use the Evaluation Board FOR EVALUATION PURPOSES ONLY. Customer understands and agrees that the Evaluation Board is provided for the sole and exclusive purpose referenced above, and agrees not to use the Evaluation Board for any other purpose. Furthermore, the license granted is expressly made subject to the following additional limitations: Customer shall not (i) rent, lease, display, sell, transfer, assign, sublicense, or distribute the Evaluation Board; and (ii) permit any Third Party to access the Evaluation Board. As used herein, the term "Third Party" includes any entity other than ADI, Customer, their employees, affiliates and in-house consultants. The Evaluation Board is NOT sold to Customer; all rights not expressly granted herein, including ownership of the Evaluation Board, are reserved by ADI. CONFIDENTIALITY. This Agreement and the Evaluation Board shall all be considered the confidential and proprietary information of ADI. Customer may not disclose or transfer any portion of the Evaluation Board to any other party for any reason. Upon discontinuation of use of the Evaluation Board or termination of this Agreement, Customer agrees to promptly return the Evaluation Board to ADI. ADDITIONAL RESTRICTIONS. Customer may not disassemble, decompile or reverse engineer chips on the Evaluation Board. Customer shall inform ADI of any occurred damages or any modifications or alterations it makes to the Evaluation Board, including but not limited to soldering or any other activity that affects the material content of the Evaluation Board. Modifications to the Evaluation Board must comply with applicable law, including but not limited to the RoHS Directive. TERMINATION. ADI may terminate this Agreement at any time upon giving written notice to Customer. Customer agrees to return to ADI the Evaluation Board at that time. LIMITATION OF LIABILITY. THE EVALUATION BOARD PROVIDED HEREUNDER IS PROVIDED "AS IS" AND ADI MAKES NO WARRANTIES OR REPRESENTATIONS OF ANY KIND WITH RESPECT TO IT. ADI SPECIFICALLY DISCLAIMS ANY REPRESENTATIONS, ENDORSEMENTS, GUARANTEES, OR WARRANTIES, EXPRESS OR IMPLIED, RELATED TO THE EVALUATION BOARD INCLUDING, BUT NOT LIMITED TO, THE IMPLIED WARRANTY OF MERCHANTABILITY, TITLE, FITNESS FOR A PARTICULAR PURPOSE OR NON-INFRINGEMENT OF INTELLECTUAL PROPERTY RIGHTS. IN NO EVENT WILL ADI AND ITS LICENSORS BE LIABLE FOR ANY INCIDENTAL, SPECIAL, INDIRECT, OR CONSEQUENTIAL DAMAGES RESULTING FROM CUSTOMER'S POSSESSION OR USE OF THE EVALUATION BOARD, INCLUDING BUT NOT LIMITED TO LOST PROFITS, DELAY COSTS, LABOR COSTS OR LOSS OF GOODWILL. ADI'S TOTAL LIABILITY FROM ANY AND ALL CAUSES SHALL BE LIMITED TO THE AMOUNT OF ONE HUNDRED US DOLLARS (\$100,000). EXPORT. Customer agrees that it will not directly or indirectly export the Evaluation Board to another country, and that it will comply with all applicable United States federal laws and regulations relating to exports. GOVERNING LAW. This Agreement shall be governed by and construed in accordance with the substantive laws of the Commonwealth of Massachusetts (excluding conflict of law rules). Any legal action regarding this Agreement will be heard in the state or federal courts having jurisdiction in Suffolk County, Massachusetts, and Customer hereby submits to the personal jurisdiction and venue of such courts. The United Nations Convention on Contracts for the International Sale of Goods shall not apply to this Agreement and is expressly disclaimed.