

Middle Power LED Series  
5630

LM561C  
CRI80



LM561C is highest performance and lm/W for fluorescent replacement



#### Features & Benefits

- 0.3 W class middle power LED
- Mold resin for high reliability
- Standard form factor for design flexibility (5.6 × 3.0 mm)

## Table of Contents

1.	Characteristics	-----	3
2.	Product Code Information	-----	5
3.	Typical Characteristics Graphs	-----	19
4.	Outline Drawing & Dimension	-----	22
5.	Reliability Test Items & Conditions	-----	23
6.	Soldering Conditions	-----	24
7.	Tape & Reel	-----	25
8.	Label Structure	-----	27
9.	Packing Structure	-----	28
10.	Precautions in Handling & Use	-----	33

## 1. Characteristics

### a) Absolute Maximum Rating

Item	Symbol	Rating	Unit	Condition
Ambient / Operating Temperature	$T_a$	-40 ~ +85	°C	-
Storage Temperature	$T_{stg}$	-40 ~ +120	°C	-
LED Junction Temperature	$T_j$	110	°C	-
Forward Current	$I_F$	200	mA	-
Peak Pulsed Forward Current	$I_{fp}$	300	mA	Duty 1/10, pulse width 10 ms
Assembly Process Temperature	-	260 <10	°C s	-
ESD (HBM)	-	±5	kV	-

b) Electro-optical Characteristics ( $I_F = 65 \text{ mA}$ ,  $T_s = 25 \text{ }^\circ\text{C}$ )

Item	Unit	CRI (R <sub>a</sub> ) Min.	Nominal CCT (K)	Rank	Bin	Min.	Typ.	Max.				
Forward Voltage (V <sub>F</sub> )	V	80	2700	XA XK	AY	2.6	-	2.7				
					AZ	2.7	-	2.8				
					A1	2.8	-	2.9				
					S4	30.0		32.0				
					S5	32.0		34.0				
					3000	S5	32.5		34.5			
						S6	34.5		36.5			
						3500	S5	33.0		35.0		
					S6		35.0		37.0			
Luminous Flux (Φ <sub>v</sub> )	lm	80	4000		S5	34.0		36.0				
					S6	36.0		38.0				
					5000	S5	35.0		37.0			
						S6	37.0		39.0			
					5700	S5	34.5		36.5			
						S6	36.5		38.5			
					6500	S5	34.0		36.0			
						S6	36.0		38.0			
					Reverse Voltage (@ 5 mA)	V				0.7	-	1.2
					Color Rendering Index (R <sub>a</sub> )	-				80	-	-
					Special CRI (R9)	-				0	-	-
					Thermal Resistance (junction to solder point)	$^\circ\text{C/W}$				-	12	16-
Beam Angle	$^\circ$				-	120	-					

**Note:**

Samsung maintains measurement tolerance of: forward voltage =  $\pm 0.1 \text{ V}$ , luminous flux =  $\pm 5 \%$ , CRI =  $\pm 3$ , R9 =  $\pm 6.5$

## 2. Product Code Information

1	2	3	4	5	6	7	8	9	10	11	12	13	14	15	16	17	18
S	P	M	W	H	T	5	4	1	M	L	5	X	A	R	K	S	0

Digit	PKG Information	Code	Specification
1 2 3	Samsung Package Middle Power	<b>SPM</b>	
4 5	Color	<b>WH</b>	White
6	Product Version	<b>T</b>	
7 8 9	Form Factor	<b>541</b>	5.6 x 3.0 x 0.7 mm; 4 pads; LM561C
10	Sorting Current (mA)	<b>M</b>	65 mA
11	Chromaticity Coordinates	<b>L</b>	ANSI Standard
12	CRI	<b>5</b>	Min. 80
13 14	Forward Voltage (V)	<b>XA</b>	2.6~2.9 (2,500 pcs/ Reel)
		<b>XK</b>	2.6~2.9 (10,000 pcs/ Reel)
15 16	CCT (K)	<b>W</b> ☆	2700 W1, W2, W3, W4, W5, W6, W7, W8, W9, WA, WB, WC, WD, WE, WF, WG
		<b>V</b> ☆	3000 V1, V2, V3, V4, V5, V6, V7, V8, V9, VA, VB, VC, VD, VE, VF, VG
		<b>U</b> ☆	3500 U1, U2, U3, U4, U5, U6, U7, U8, U9, UA, UB, UC, UD, UE, UF, UG
		<b>T</b> ☆	4000 Bin Code: T1, T2, T3, T4, T5, T6, T7, T8, T9, TA, TB, TC, TD, TE, TF, TG
		<b>R</b> ☆	5000 R1, R2, R3, R4, R5, R6, R7, R8, R9, RA, RB, RC, RD, RE, RF, RG
		<b>Q</b> ☆	5700 Q1, Q2, Q3, Q4, Q5, Q6, Q7, Q8, Q9, QA, QB, QC, QD, QE, QF, QG
		<b>P</b> ☆	6500 P1, P2, P3, P4, P5, P6, P7, P8, P9, PA, PB, PC, PD, PE, PF, PG
		☆ "0" (Whole bin)	"M" (Quarter bin) "K" (K Kitting) or "S" (S Kitting)
17 18	Luminous Flux	<b>S0</b>	S4, S5, S6
		<b>S4</b>	Bin Code: S4 (Only 2700K)
		<b>S5</b>	S5
		<b>S6</b>	S6 (Except 2700K)

a) Luminous Flux Bins ( $I_F = 65 \text{ mA}$ ,  $T_s = 25^\circ\text{C}$ )

CRI (R <sub>a</sub> ) Min.	Nominal CCT (K)	Product Code	Flux Bin	Flux Range ( $\Phi_v$ , lm)	
80	2700	SPMWHT541ML5X◆W☆S0	S4	30.0 ~32.0	
			S5	32.0 ~34.0	
		SPMWHT541ML5X◆W☆S4	S4	30.0 ~32.0	
			S5	32.0 ~34.0	
		3000	SPMWHT541ML5X◆V☆S0	S5	32.5 ~ 34.5
				S6	34.5 ~ 36.5
	SPMWHT541ML5X◆V☆S5		S5	32.5 ~ 34.5	
			S6	34.5 ~ 36.5	
	3500		SPMWHT541ML5X◆U☆S0	S5	33.0 ~ 35.0
				S6	35.0 ~ 37.0
		SPMWHT541ML5X◆U☆S5	S5	33.0 ~ 35.0	
			S6	35.0 ~ 37.0	
		4000	SPMWHT541ML5X◆T☆S0	S5	34.0 ~ 36.0
				S6	36.0 ~ 38.0
	SPMWHT541ML5X◆T☆S5		S5	34.0 ~ 36.0	
			S6	36.0 ~ 38.0	
	5000		SPMWHT541ML5X◆R☆S0	S5	35.0 ~ 37.0
				S6	37.0 ~ 39.0
		SPMWHT541ML5X◆R☆S5	S5	35.0 ~ 37.0	
			S6	37.0 ~ 39.0	
		5700	SPMWHT541ML5X◆Q☆S0	S5	34.5 ~ 36.5
				S6	36.5 ~ 38.5
	SPMWHT541ML5X◆Q☆S5		S5	34.5 ~ 36.5	
			S6	36.5 ~ 38.5	
6500	SPMWHT541ML5X◆P☆S0		S5	34.0 ~ 36.0	
			S6	36.0 ~ 38.0	
	SPMWHT541ML5X◆P☆S5	S5	34.0 ~ 36.0		
		S6	36.0 ~ 38.0		

**Note:**

"◆" can be "A" (2,500pcs) or "K" (10,000pcs) of reel taping

"☆" can be "0" (Whole bin), "M" (Quarter bin), "K" (K Kitting) or "S" (S Kitting) of the color binning

## b) Kitting rule

### 1) K Kitting bin Concept

1. Under agreement between customer and SAMSUNG ELECTRONICS, SAMSUNG can supply kitting bin (VF, Color, lm).
2. A forward voltage (VF) of kitting bin is combined by a pair of same VF rank such as (A1+A1), (AY+AY) or (AZ+AZ).
3. A Chromaticity Coordinates of kitting bin is mixed by kitting procedure. (below kitting simulation)
4. A luminous flux(lm) of kitting bin is combined by a pair of IV rank such as (S4+S4), (S5+S5) or (S6+S6).

#### [Kitting example]

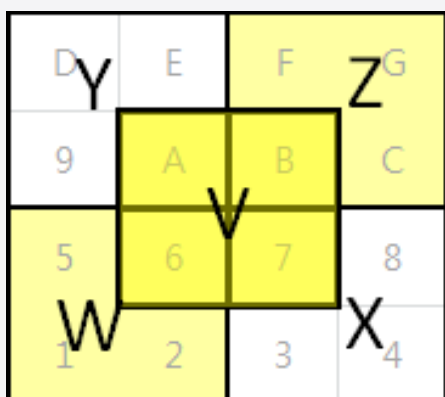

#### [Binning Information]

	Bin #1	Bin #2	Priority
VF	AY	AY	
	AZ	AZ	
	A1	A1	
CIE	W (1, 2, 5, 6)	Z (B, C, F, G)	
	V (6, 7, A, B)	V (6, 7, A, B)	
	X (3, 4, 7, 8)	Y (9, A, D, E)	
IV	S4	S4	Only 2700K
	S5	S5	
	S6	S6	Except 2700K

※ Each of V, W, X, Y and Z can be one bin without details division.

## 2) S Kitting bin Concept

1. Under agreement between customer and SAMSUNG ELECTRONICS, SAMSUNG can supply kitting bin (VF, Color, lm).
2. A forward voltage (VF) of kitting bin is combined by a pair of same VF rank such as (A1+A1), (AY+AY) or (AZ+AZ).
3. A Chromaticity Coordinates of kitting bin is mixed by kitting procedure. (below kitting simulation)
4. A luminous flux(lm) of kitting bin is combined by a pair of IV rank such as (S4+S4), (S5+S5) or (S6+S6).

### [Kitting example]

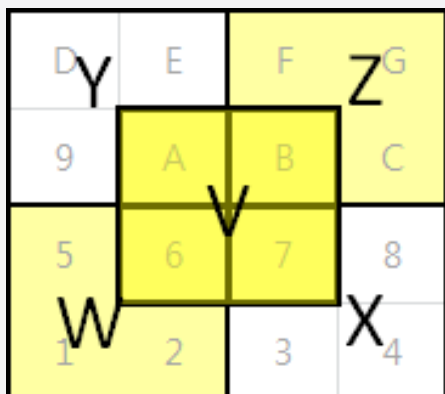

### [Binning Information]

	Bin #1	Bin #2	Priority
VF	AY	AY	
	AZ	AZ	
	A1	A1	
CIE	W (1, 2, 5)	B	1
	X (3, 4, 8)	A	1
	Y (9, D, E)	7	1
	Z (C, F, G)	6	1
	6	6	2
	7	7	2
	A	A	2
	B	B	2
	V (6, 7, A, B)	V (6, 7, A, B)	3
IV	S4	S4	Only 2700K
	S5	S5	
	S6	S6	Except 2700K

※ Each of V, W, X, Y and Z can be one bin without details division.



c) Color Bins ( $I_F = 65 \text{ mA}$ ,  $T_s = 25 \text{ }^\circ\text{C}$ )

CRI ( $R_a$ ) Min.	Nominal CCT (K)	Product Code	Color Rank	Chromaticity Bins
80	2700	SPMWHT541ML5XAW0S0	W0 (Whole bin)	W1, W2, W3, W4, W5, W6, W7, W8, W9, WA, WB, WC, WD, WE, WF, WG
		SPMWHT541ML5XAWMS0	WM (Quarter bin)	W6, W7, WA, WB
		SPMWHT541ML5XAWSS0	WS (S Kitting)	W6, W7, WA, WB, WV, WW, WX, WY, WZ
		SPMWHT541ML5XAWKS0	WK (K Kitting)	WV, WW, WX, WY, WZ
	3000	SPMWHT541ML5XAV0S0	V0 (Whole bin)	V1, V2, V3, V4, V5, V6, V7, V8, V9, VA, VB, VC, VD, VE, VF, VG
		SPMWHT541ML5XAVMS0	VM (Quarter bin)	V6, V7, VA, VB
		SPMWHT541ML5XAVSS0	VS (S Kitting)	V6, V7, VA, VB, VV, VW, VX, VY, VZ
		SPMWHT541ML5XAVKS0	VK (K Kitting)	VV, VW, VX, VY, VZ
	3500	SPMWHT541ML5XAU0S0	U0 (Whole bin)	U1, U2, U3, U4, U5, U6, U7, U8, U9, UA, UB, UC, UD, UE, UF, UG
		SPMWHT541ML5XAUMS0	UM (Quarter bin)	U6, U7, UA, UB
		SPMWHT541ML5XAUSS0	US (S Kitting)	U6, U7, UA, UB, UV, UW, UX, UY, UZ
		SPMWHT541ML5XAUKS0	UK (K Kitting)	UV, UW, UX, UY, UZ
4000	SPMWHT541ML5XAT0S0	T0 (Whole bin)	T1, T2, T3, T4, T5, T6, T7, T8, T9, TA, TB, TC, TD, TE, TF, TG	
	SPMWHT541ML5XATMS0	TM (Quarter bin)	T6, T7, TA, TB	
	SPMWHT541ML5XATSS0	TS (S Kitting)	T6, T7, TA, TB, TV, TW, TX, TY, TZ	
	SPMWHT541ML5XATKS0	TK (K Kitting)	TV, TW, TX, TY, TZ	
5000	SPMWHT541ML5XAR0S0	R0 (Whole bin)	R1, R2, R3, R4, R5, R6, R7, R8, R9, RA, RB, RC, RD, RE, RF, RG	
	SPMWHT541ML5XARMS0	RM (Quarter bin)	R6, R7, RA, RB	
	SPMWHT541ML5XARSS0	RS (S Kitting)	R6, R7, RA, RB, RV, RW, RX, RY, RZ	
	SPMWHT541ML5XARKS0	RK (K Kitting)	RV, RW, RX, RY, RZ	

### c) Color Bins ( $I_F = 65 \text{ mA}$ , $T_s = 25 \text{ }^\circ\text{C}$ )

CRI ( $R_a$ ) Min.	Nominal CCT (K)	Product Code	Color Rank	Chromaticity Bins
80	5700	SPMWHT541ML5XAQ0S0	Q0 (Whole bin)	Q1, Q2, Q3, Q4, Q5, Q6, Q7, Q8, Q9, QA, QB, QC, QD, QE, QF, QG
		SPMWHT541ML5XAQMS0	QM (Quarter bin)	Q6, Q7, QA, QB
		SPMWHT541ML5XAQSS0	QS (S Kitting)	Q6, Q7, QA, QB, QV, QW, QX, QY, QZ
		SPMWHT541ML5XAQKS0	QK (K Kitting)	QV, QW, QX, QY, QZ
	6500	SPMWHT541ML5XAP0S0	P0 (Whole bin)	P1, P2, P3, P4, P5, P6, P7, P8, P9, PA, PB, PC, PD, PE, PF, PG
		SPMWHT541ML5XAPMS0	PM (Quarter bin)	P6, P7, PA, PB
		SPMWHT541ML5XAPSS0	PS (S Kitting)	P6, P7, PA, PB, PV, PW, PX, PY, PZ
		SPMWHT541ML5XAPKS0	PK (K Kitting)	PV, PW, PX, PY, PZ

### d) Voltage Bins ( $I_F = 65 \text{ mA}$ , $T_s = 25 \text{ }^\circ\text{C}$ )

CRI ( $R_a$ ) Min.	Nominal CCT (K)	Product Code	Voltage Rank	Voltage Bin	Voltage Range (V)
80	-	-	XA (XK)	AY	2.6 ~ 2.7
				AZ	2.7 ~ 2.8
				A1	2.8 ~ 2.9

e) Chromaticity Region & Coordinates ( $I_F = 65 \text{ mA}$ ,  $T_s = 25 \text{ }^\circ\text{C}$ )

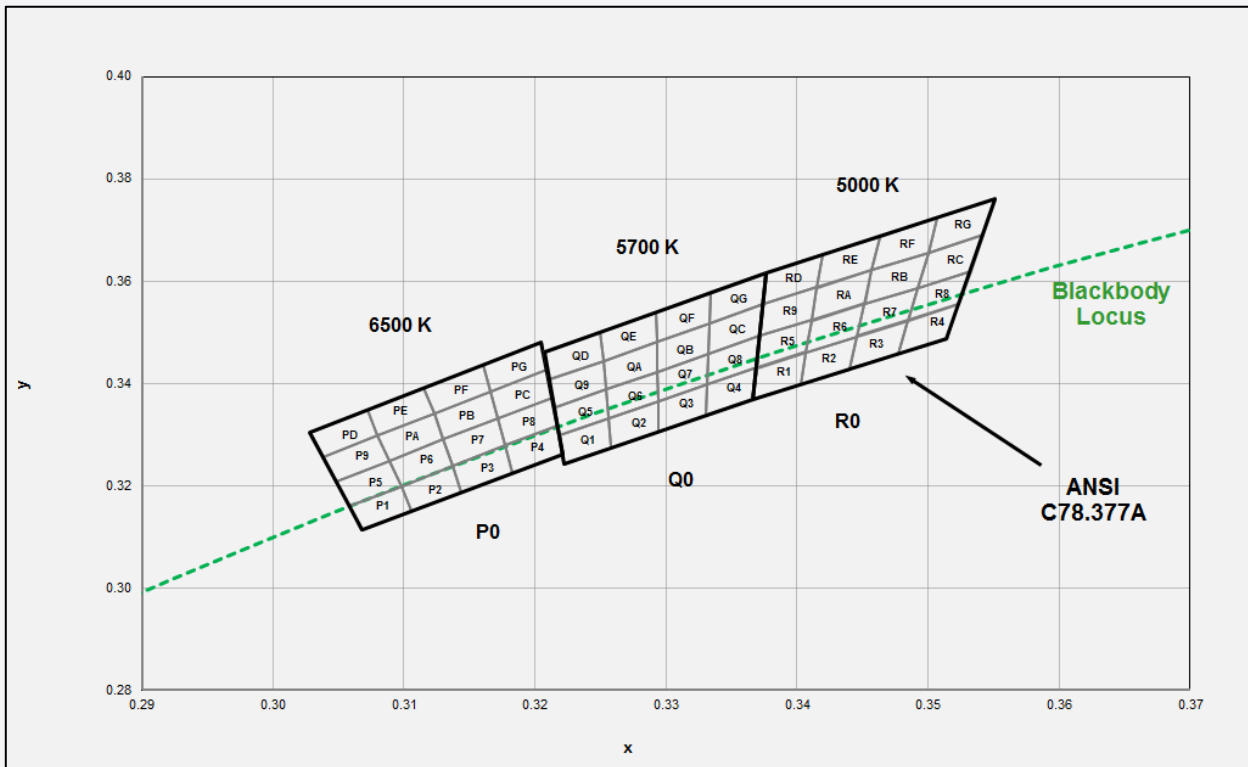
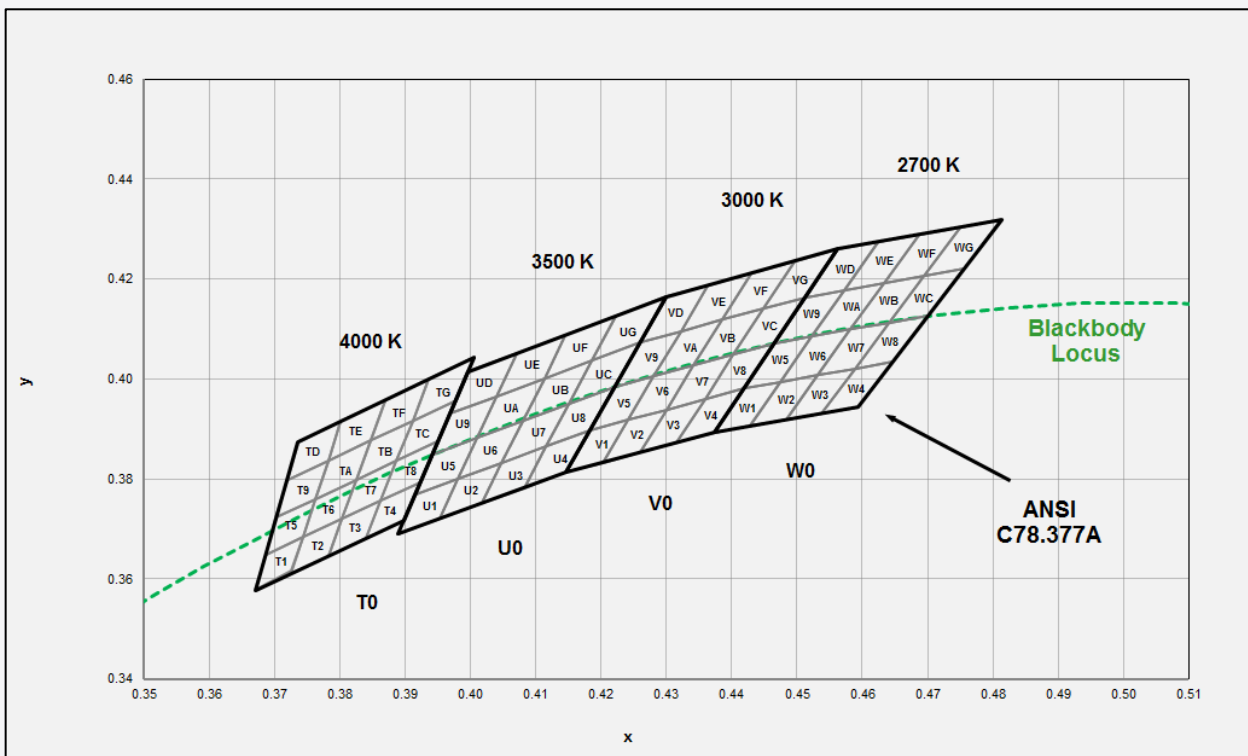

## e) Chromaticity Region &amp; Coordinates (IF = 65 mA, Ts = 25 °C)

Region	CIE x	CIE y	Region	CIE x	CIE y
<b>W rank (2700 K)</b>					
W1	0.4373	0.3893	W9	0.4465	0.4071
	0.4418	0.3981		0.4513	0.4164
	0.4475	0.3994		0.4573	0.4178
	0.4428	0.3906		0.4523	0.4085
W2	0.4428	0.3906	WA	0.4523	0.4085
	0.4475	0.3994		0.4573	0.4178
	0.4532	0.4008		0.4634	0.4193
	0.4483	0.3919		0.4582	0.4099
W3	0.4483	0.3919	WB	0.4582	0.4099
	0.4532	0.4008		0.4634	0.4193
	0.4589	0.4021		0.4695	0.4207
	0.4538	0.3931		0.4641	0.4112
W4	0.4538	0.3931	WC	0.4641	0.4112
	0.4589	0.4021		0.4695	0.4207
	0.4646	0.4034		0.4756	0.4221
	0.4593	0.3944		0.4700	0.4126
W5	0.4418	0.3981	WD	0.4513	0.4164
	0.4465	0.4071		0.4562	0.4260
	0.4523	0.4085		0.4624	0.4274
	0.4475	0.3994		0.4573	0.4178
W6	0.4475	0.3994	WE	0.4573	0.4178
	0.4523	0.4085		0.4624	0.4274
	0.4582	0.4099		0.4687	0.4289
	0.4532	0.4008		0.4634	0.4193
W7	0.4532	0.4008	WF	0.4634	0.4193
	0.4582	0.4099		0.4687	0.4289
	0.4641	0.4112		0.4750	0.4304
	0.4589	0.4021		0.4695	0.4207
W8	0.4589	0.4021	WG	0.4695	0.4207
	0.4641	0.4112		0.4750	0.4304
	0.4700	0.4126		0.4813	0.4319
	0.4646	0.4034		0.4756	0.4221

Region	CIE x	CIE y	Region	CIE x	CIE y
<b>V rank (3000 K)</b>					
V1	0.4147	0.3814	V9	0.4221	0.3984
	0.4183	0.3898		0.4259	0.4073
	0.4242	0.3919		0.4322	0.4096
	0.4203	0.3833		0.4281	0.4006
V2	0.4203	0.3833	VA	0.4281	0.4006
	0.4242	0.3919		0.4322	0.4096
	0.4300	0.3939		0.4385	0.4119
	0.4259	0.3853		0.4342	0.4028
V3	0.4259	0.3853	VB	0.4342	0.4028
	0.4300	0.3939		0.4385	0.4119
	0.4359	0.3960		0.4449	0.4141
	0.4316	0.3873		0.4403	0.4049
V4	0.4316	0.3873	VC	0.4403	0.4049
	0.4359	0.3960		0.4449	0.4141
	0.4418	0.3981		0.4513	0.4164
	0.4373	0.3893		0.4465	0.4071
V5	0.4183	0.3898	VD	0.4259	0.4073
	0.4221	0.3984		0.4299	0.4165
	0.4281	0.4006		0.4364	0.4188
	0.4242	0.3919		0.4322	0.4096
V6	0.4242	0.3919	VE	0.4322	0.4096
	0.4281	0.4006		0.4364	0.4188
	0.4342	0.4028		0.4430	0.4212
	0.4300	0.3939		0.4385	0.4119
V7	0.4300	0.3939	VF	0.4385	0.4119
	0.4342	0.4028		0.4430	0.4212
	0.4403	0.4049		0.4496	0.4236
	0.4359	0.3960		0.4449	0.4141
V8	0.4359	0.3960	VG	0.4449	0.4141
	0.4403	0.4049		0.4496	0.4236
	0.4465	0.4071		0.4562	0.4260
	0.4418	0.3981		0.4513	0.4164

e) Chromaticity Region & Coordinates

Region	CIE x	CIE y	Region	CIE x	CIE y
<b>U rank (3500 K)</b>					
U1	0.3889	0.3690	U9	0.3941	0.3848
	0.3915	0.3768		0.3968	0.3930
	0.3981	0.3800		0.4040	0.3966
	0.3953	0.3720		0.4010	0.3882
U2	0.3953	0.3720	UA	0.4010	0.3882
	0.3981	0.3800		0.4040	0.3966
	0.4048	0.3832		0.4113	0.4001
	0.4017	0.3751		0.4080	0.3916
U3	0.4017	0.3751	UB	0.4080	0.3916
	0.4048	0.3832		0.4113	0.4001
	0.4116	0.3865		0.4186	0.4037
	0.4082	0.3782		0.4150	0.3950
U4	0.4082	0.3782	UC	0.4150	0.3950
	0.4116	0.3865		0.4186	0.4037
	0.4183	0.3898		0.4259	0.4073
	0.4147	0.3814		0.4221	0.3984
U5	0.3915	0.3768	UD	0.3968	0.3930
	0.3941	0.3848		0.3996	0.4015
	0.4010	0.3882		0.4071	0.4052
	0.3981	0.3800		0.4040	0.3966
U6	0.3981	0.3800	UE	0.4040	0.3966
	0.4010	0.3882		0.4071	0.4052
	0.4080	0.3916		0.4146	0.4089
	0.4048	0.3832		0.4113	0.4001
U7	0.4048	0.3832	UF	0.4113	0.4001
	0.4080	0.3916		0.4146	0.4089
	0.4150	0.3950		0.4222	0.4127
	0.4116	0.3865		0.4186	0.4037
U8	0.4116	0.3865	UG	0.4186	0.4037
	0.4150	0.3950		0.4222	0.4127
	0.4221	0.3984		0.4299	0.4165
	0.4183	0.3898		0.4259	0.4073

Region	CIE x	CIE y	Region	CIE x	CIE y
<b>T rank (4000 K)</b>					
T1	0.3670	0.3578	T9	0.3702	0.3722
	0.3726	0.3612		0.3763	0.3760
	0.3744	0.3685		0.3782	0.3837
	0.3686	0.3649		0.3719	0.3797
T2	0.3726	0.3612	TA	0.3763	0.3760
	0.3783	0.3646		0.3825	0.3798
	0.3804	0.3721		0.3847	0.3877
	0.3744	0.3685		0.3782	0.3837
T3	0.3783	0.3646	TB	0.3825	0.3798
	0.3840	0.3681		0.3887	0.3836
	0.3863	0.3758		0.3912	0.3917
	0.3804	0.3721		0.3847	0.3877
T4	0.3840	0.3681	TC	0.3887	0.3837
	0.3898	0.3716		0.3950	0.3875
	0.3924	0.3794		0.3978	0.3958
	0.3863	0.3758		0.3912	0.3917
T5	0.3686	0.3649	TD	0.3719	0.3797
	0.3744	0.3685		0.3782	0.3837
	0.3763	0.3760		0.3802	0.3916
	0.3702	0.3722		0.3736	0.3874
T6	0.3744	0.3685	TE	0.3782	0.3837
	0.3804	0.3721		0.3847	0.3877
	0.3825	0.3798		0.3869	0.3958
	0.3763	0.376		0.3802	0.3916
T7	0.3804	0.3721	TF	0.3847	0.3877
	0.3863	0.3758		0.3912	0.3917
	0.3887	0.3836		0.3937	0.4001
	0.3825	0.3798		0.3869	0.3958
T8	0.3863	0.3758	TG	0.3912	0.3917
	0.3924	0.3794		0.3978	0.3958
	0.3950	0.3875		0.4006	0.4044
	0.3887	0.3836		0.3937	0.4001

## e) Chromaticity Region &amp; Coordinates

Region	CIE x	CIE y	Region	CIE x	CIE y
<b>R rank (5000 K)</b>					
R1	0.3366	0.3369	R9	0.3371	0.3490
	0.3369	0.3430		0.3374	0.3553
	0.3407	0.3460		0.3415	0.3587
	0.3403	0.3398		0.3411	0.3522
R2	0.3403	0.3398	RA	0.3411	0.3522
	0.3407	0.3460		0.3415	0.3587
	0.3446	0.3491		0.3457	0.3621
	0.3440	0.3427		0.3451	0.3554
R3	0.3440	0.3427	RB	0.3451	0.3554
	0.3446	0.3491		0.3457	0.3621
	0.3485	0.3522		0.3500	0.3655
	0.3478	0.3457		0.3492	0.3587
R4	0.3478	0.3457	RC	0.3492	0.3587
	0.3485	0.3522		0.3500	0.3655
	0.3524	0.3554		0.3542	0.3690
	0.3515	0.3487		0.3533	0.3620
R5	0.3369	0.3430	RD	0.3374	0.3553
	0.3371	0.3490		0.3376	0.3616
	0.3411	0.3522		0.3420	0.3652
	0.3407	0.3460		0.3415	0.3587
R6	0.3407	0.3460	RE	0.3415	0.3587
	0.3411	0.3522		0.3420	0.3652
	0.3451	0.3554		0.3463	0.3687
	0.3446	0.3491		0.3457	0.3621
R7	0.3446	0.3491	RF	0.3457	0.3621
	0.3451	0.3554		0.3463	0.3687
	0.3492	0.3587		0.3507	0.3724
	0.3485	0.3522		0.3500	0.3655
R8	0.3485	0.3522	RG	0.3500	0.3655
	0.3492	0.3587		0.3507	0.3724
	0.3533	0.3620		0.3551	0.3760
	0.3524	0.3554		0.3542	0.3690

Region	CIE x	CIE y	Region	CIE x	CIE y
<b>Q rank (5700 K)</b>					
Q1	0.3218	0.3298	Q9	0.3211	0.3407
	0.3222	0.3243		0.3215	0.3353
	0.3258	0.3275		0.3254	0.3388
	0.3256	0.3331		0.3252	0.3444
Q2	0.3256	0.3331	QA	0.3252	0.3444
	0.3258	0.3275		0.3254	0.3388
	0.3294	0.3306		0.3293	0.3423
	0.3294	0.3364		0.3293	0.3481
Q3	0.3294	0.3364	QB	0.3293	0.3481
	0.3294	0.3306		0.3293	0.3423
	0.333	0.3338		0.3332	0.3458
	0.3331	0.3398		0.3333	0.3518
Q4	0.3331	0.3398	QC	0.3333	0.3518
	0.333	0.3338		0.3332	0.3458
	0.3366	0.3369		0.3371	0.3493
	0.3369	0.3431		0.3374	0.3554
Q5	0.3215	0.3353	QD	0.3207	0.3462
	0.3218	0.3298		0.3211	0.3407
	0.3256	0.3331		0.3252	0.3444
	0.3254	0.3388		0.325	0.3501
Q6	0.3254	0.3388	QE	0.325	0.3501
	0.3256	0.3331		0.3252	0.3444
	0.3294	0.3364		0.3293	0.3481
	0.3293	0.3423		0.3292	0.3539
Q7	0.3293	0.3423	QF	0.3292	0.3539
	0.3294	0.3364		0.3293	0.3481
	0.3331	0.3398		0.3333	0.3518
	0.3332	0.3458		0.3334	0.3578
Q8	0.3332	0.3458	QG	0.3334	0.3578
	0.3331	0.3398		0.3333	0.3518
	0.3369	0.3431		0.3374	0.3554
	0.3371	0.3493		0.3376	0.3616

## e) Chromaticity Region &amp; Coordinates

Region	CIE x	CIE y	Region	CIE x	CIE y
<b>P rank (6500 K)</b>					
P1	0.3068	0.3113	P9	0.3048	0.3207
	0.3106	0.3150		0.3089	0.3249
	0.3098	0.3199		0.3080	0.3298
	0.3058	0.3160		0.3038	0.3256
P2	0.3106	0.3150	PA	0.3089	0.3249
	0.3144	0.3186		0.3130	0.3290
	0.3137	0.3238		0.3123	0.3341
	0.3098	0.3199		0.3080	0.3298
P3	0.3144	0.3186	PB	0.3130	0.3290
	0.3183	0.3224		0.3172	0.3332
	0.3177	0.3278		0.3166	0.3384
	0.3137	0.3238		0.3123	0.3341
P4	0.3183	0.3224	PC	0.3172	0.3332
	0.3221	0.3261		0.3213	0.3373
	0.3217	0.3317		0.3209	0.3427
	0.3177	0.3278		0.3166	0.3384
P5	0.3058	0.3160	PD	0.3038	0.3256
	0.3098	0.3199		0.3080	0.3298
	0.3089	0.3249		0.3072	0.3348
	0.3048	0.3207		0.3028	0.3304
P6	0.3098	0.3199	PE	0.3080	0.3298
	0.3137	0.3238		0.3123	0.3341
	0.3130	0.3290		0.3115	0.3391
	0.3089	0.3249		0.3072	0.3348
P7	0.3137	0.3238	PF	0.3123	0.3341
	0.3177	0.3278		0.3166	0.3384
	0.3172	0.3332		0.3160	0.3436
	0.3130	0.3290		0.3115	0.3391
P8	0.3177	0.3278	PG	0.3166	0.3384
	0.3217	0.3317		0.3209	0.3427
	0.3213	0.3373		0.3205	0.3481
	0.3172	0.3332		0.3160	0.3436

**Note:**

Samsung maintains measurement tolerance of: Cx, Cy =  $\pm 0.005$

f) Kitting Chromaticity Region & Coordinates (IF = 65 mA, Ts = 25 °C)

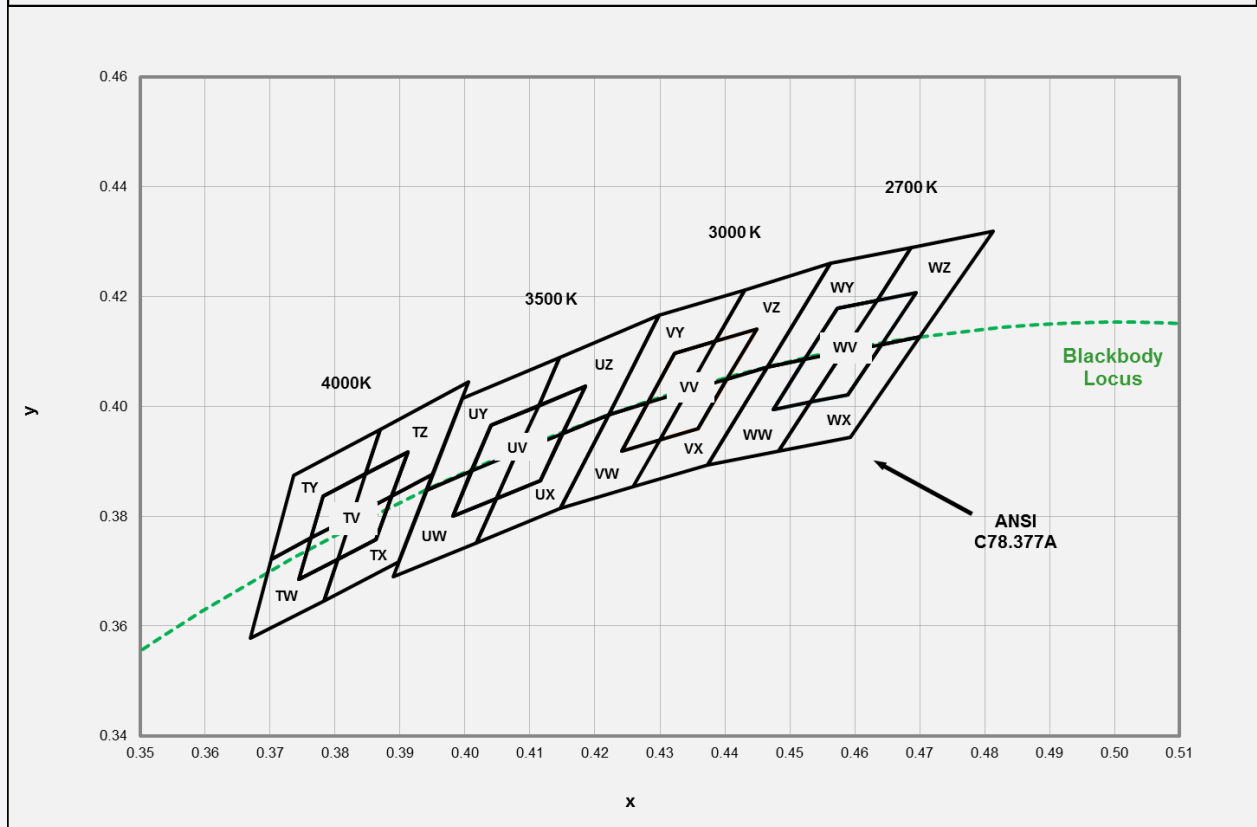
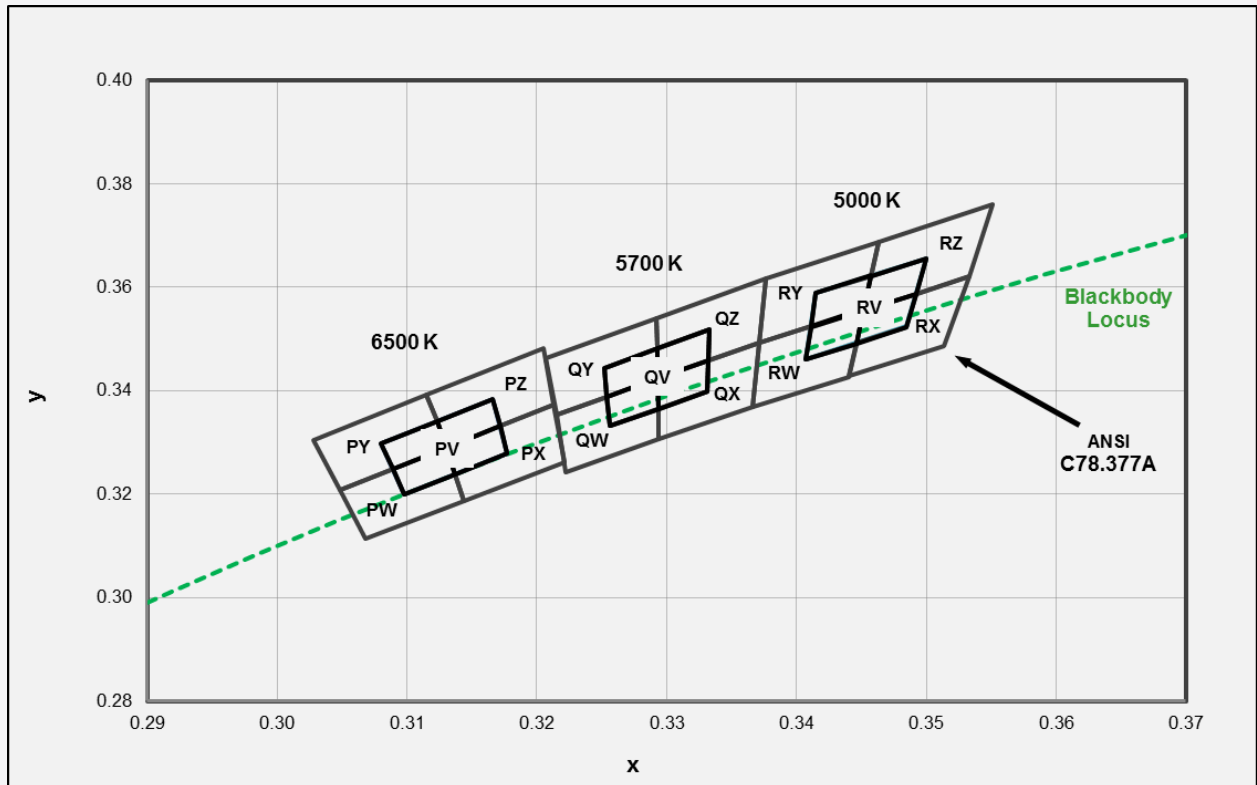



f) Kitting Chromaticity Region & Coordinates ( $I_f = 65 \text{ mA}$ ,  $T_s = 25 \text{ }^\circ\text{C}$ )

Region	CIE x	CIE y	Region	CIE x	CIE y
<b>W rank (2700 K)</b>					
WV	0.4475	0.3994			
	0.4589	0.4021			
	0.4695	0.4207			
	0.4573	0.4178			
WW	0.4373	0.3893	WY	0.4465	0.4071
	0.4483	0.3919		0.4582	0.4099
	0.4582	0.4099		0.4687	0.4289
	0.4465	0.4071		0.4562	0.4260
WX	0.4483	0.3919	WZ	0.4582	0.4099
	0.4593	0.3944		0.4700	0.4126
	0.4700	0.4126		0.4813	0.4319
	0.4582	0.4099		0.4687	0.4289

Region	CIE x	CIE y	Region	CIE x	CIE y
<b>V rank (3000 K)</b>					
VV	0.4242	0.3919			
	0.4359	0.3960			
	0.4449	0.4141			
	0.4322	0.4096			
VW	0.4147	0.3814	VY	0.4221	0.3984
	0.4259	0.3853		0.4342	0.4028
	0.4342	0.4028		0.4430	0.4212
	0.4221	0.3984		0.4299	0.4165
VX	0.4259	0.3853	VZ	0.4342	0.4028
	0.4373	0.3893		0.4465	0.4071
	0.4465	0.4071		0.4562	0.4260
	0.4342	0.4028		0.4430	0.4212

Region	CIE x	CIE y	Region	CIE x	CIE y
<b>U rank (3500 K)</b>					
UV	0.3981	0.3800			
	0.4116	0.3865			
	0.4186	0.4037			
	0.4040	0.3966			
UW	0.3889	0.3690	UY	0.3941	0.3848
	0.4017	0.3751		0.4080	0.3916
	0.4080	0.3916		0.4146	0.4089
	0.3941	0.3848		0.3996	0.4015
UX	0.4017	0.3751	UZ	0.4080	0.3916
	0.4147	0.3814		0.4221	0.3984
	0.4221	0.3984		0.4299	0.4165
	0.4080	0.3916		0.4146	0.4089

Region	CIE x	CIE y	Region	CIE x	CIE y
<b>T rank (4000 K)</b>					
TV	0.3744	0.3685			
	0.3863	0.3758			
	0.3912	0.3917			
	0.3782	0.3837			
TW	0.3670	0.3578	TY	0.3702	0.3722
	0.3783	0.3646		0.3825	0.3798
	0.3825	0.3798		0.3869	0.3958
	0.3702	0.3722		0.3736	0.3874
TX	0.3783	0.3646	TZ	0.3825	0.3798
	0.3898	0.3716		0.3950	0.3875
	0.3950	0.3875		0.4006	0.4044
	0.3825	0.3798		0.3869	0.3958

## f) Kitting Chromaticity Region &amp; Coordinates

Region	CIE x	CIE y	Region	CIE x	CIE y
<b>R rank (5000 K)</b>					
RV	0.3407	0.3460			
	0.3485	0.3524			
	0.3500	0.3655			
	0.3415	0.3588			
RW	0.3366	0.3369	RY	0.3371	0.3493
	0.3440	0.3427		0.3451	0.3554
	0.3451	0.3554		0.3463	0.3687
	0.3371	0.3493		0.3376	0.3616
RX	0.3440	0.3428	RZ	0.3457	0.3621
	0.3514	0.3487		0.3500	0.3655
	0.3533	0.3620		0.3492	0.3587
	0.3451	0.3554		0.3533	0.3620

Region	CIE x	CIE y	Region	CIE x	CIE y
<b>Q rank (5700 K)</b>					
QV	0.3256	0.3331			
	0.3331	0.3398			
	0.3333	0.3518			
	0.3252	0.3444			
QW	0.3222	0.3243	QY	0.3215	0.3353
	0.3294	0.3306		0.3293	0.3423
	0.3293	0.3423		0.3292	0.3539
	0.3215	0.3353		0.3207	0.3462
QX	0.3294	0.3306	QZ	0.3293	0.3423
	0.3366	0.3369		0.3371	0.3493
	0.3371	0.3493		0.3376	0.3616
	0.3293	0.3423		0.3292	0.3539

Region	CIE x	CIE y	Region	CIE x	CIE y
<b>P rank (6500 K)</b>					
PV	0.3098	0.3199			
	0.3177	0.3278			
	0.3166	0.3384			
	0.3080	0.3298			
PW	0.3068	0.3113	PY	0.3048	0.3207
	0.3144	0.3186		0.3130	0.3290
	0.3130	0.3290		0.3115	0.3391
	0.3048	0.3207		0.3028	0.3304
PX	0.3144	0.3186	PZ	0.3130	0.3290
	0.3221	0.3261		0.3213	0.3373
	0.3213	0.3373		0.3205	0.3481
	0.3130	0.3290		0.3115	0.3391

**Note:** Samsung maintains measurement tolerance of:

$$C_x, C_y = \pm 0.005$$

### 3. Typical Characteristics Graphs

#### a) Spectrum Distribution ( $I_F = 65 \text{ mA}$ , $T_s = 25 \text{ }^\circ\text{C}$ )

CRI Ra 80+

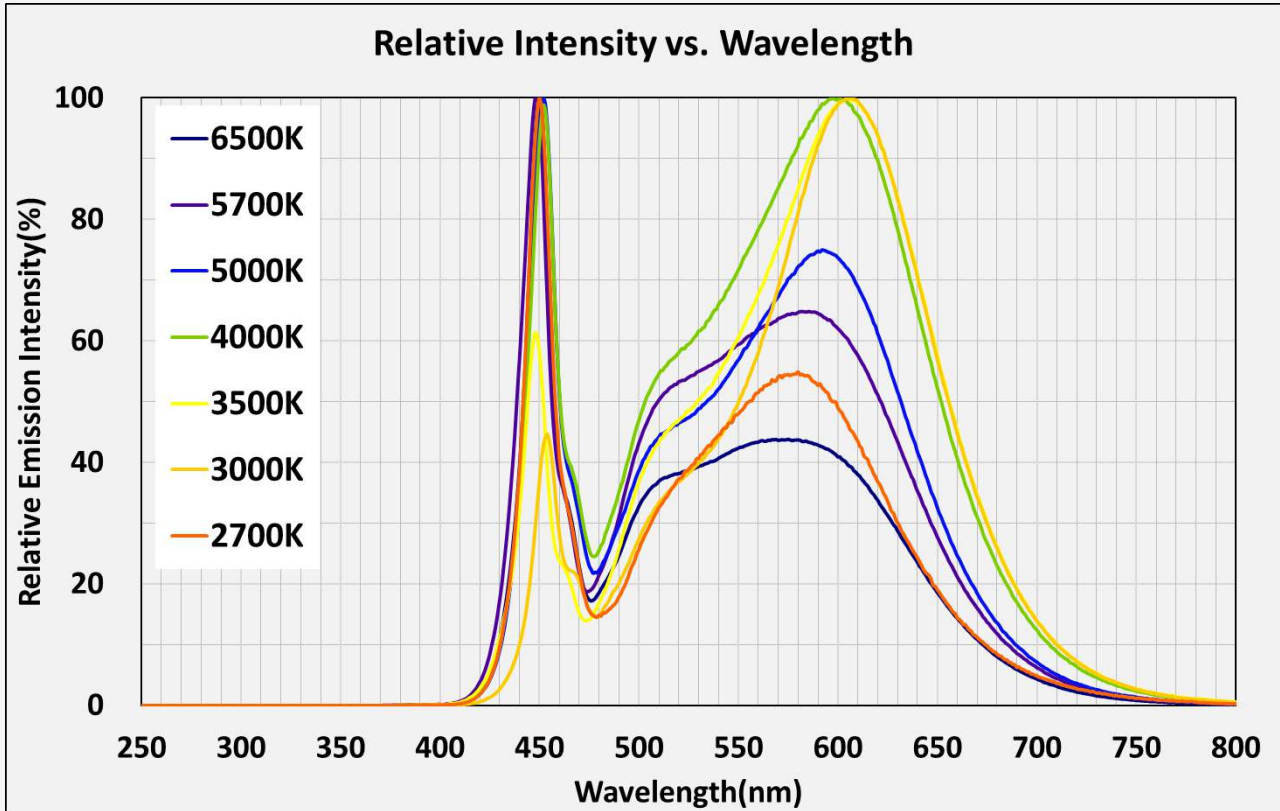

#### b) Forward Current Characteristics ( $T_s = 25 \text{ }^\circ\text{C}$ )

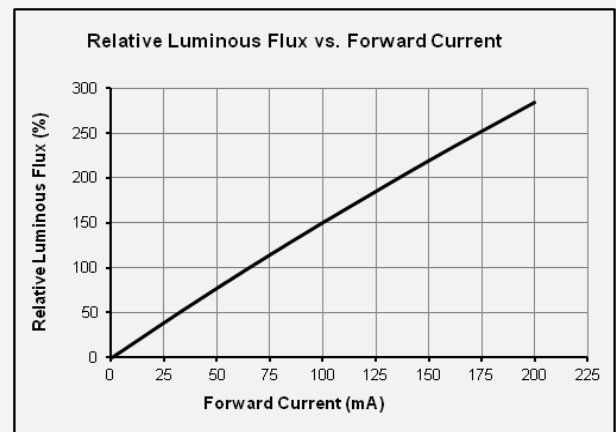
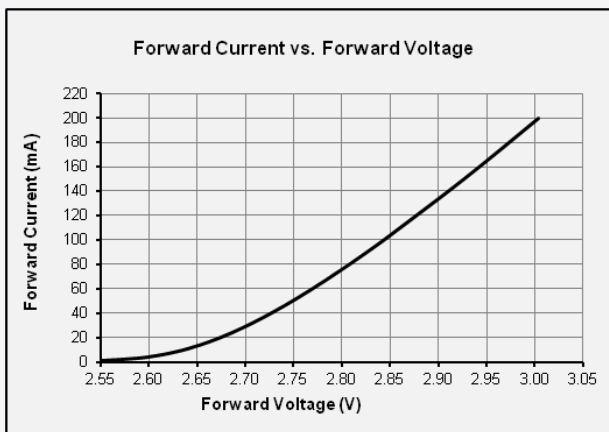

c) Temperature Characteristics ( $I_F = 65 \text{ mA}$ )

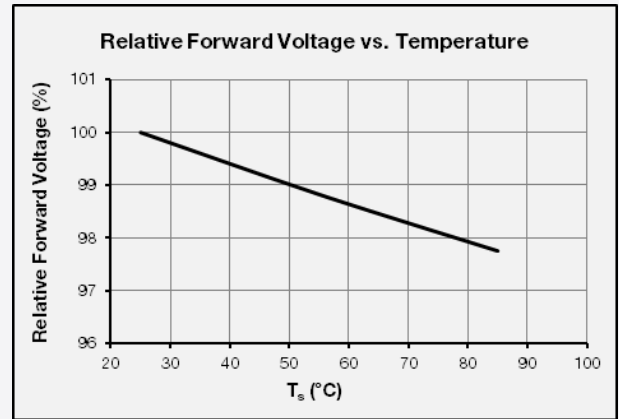
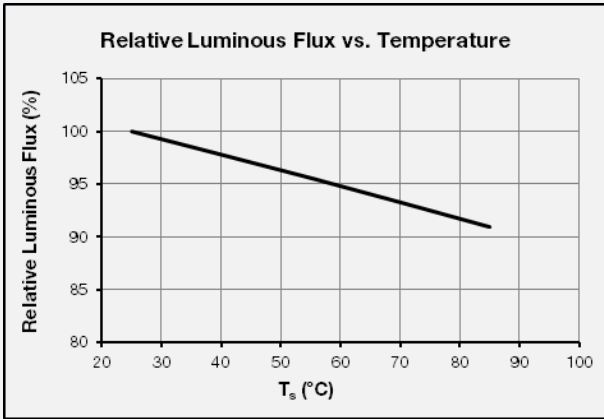

d) Color Shift Characteristics ( $T_s = 25 \text{ °C}$ ,  $I_F = 65 \text{ mA}$ )

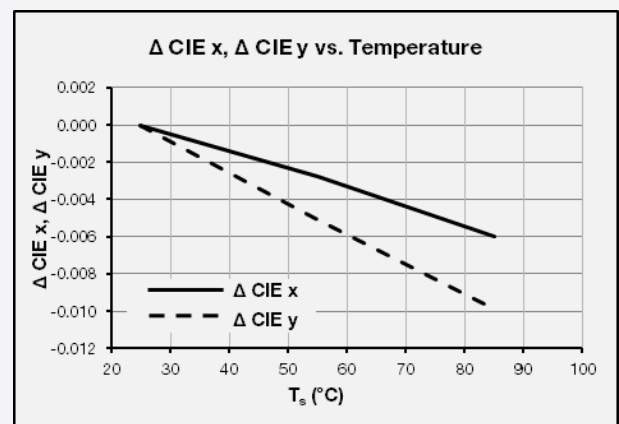
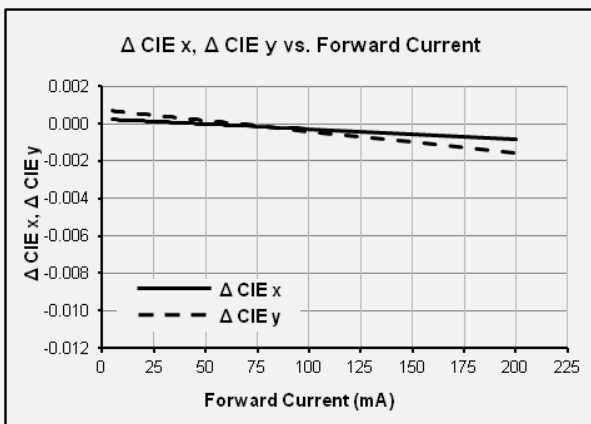

e) Derating Curve

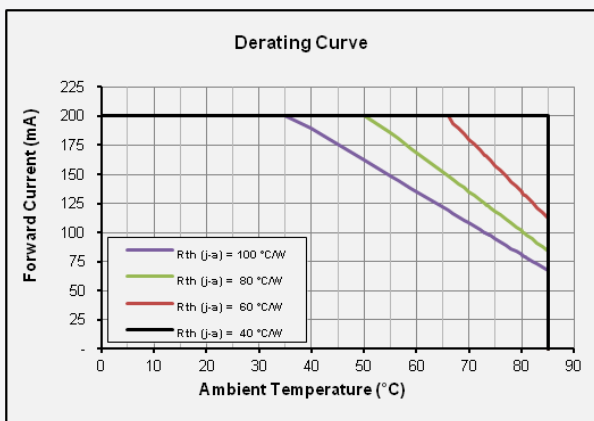

f) Beam Angle Characteristics ( $I_F = 65 \text{ mA}$ ,  $T_s = 25 \text{ }^\circ\text{C}$ )

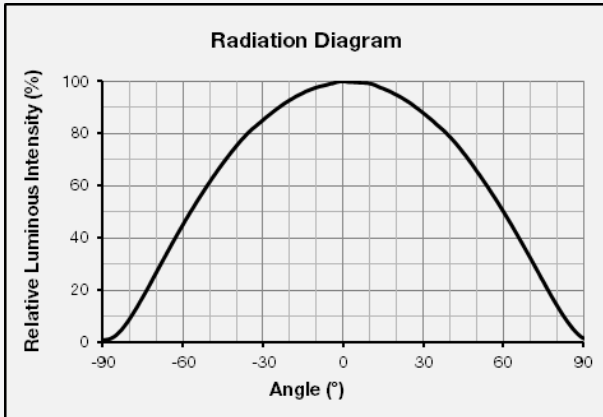

#### 4. Outline Drawing & Dimension

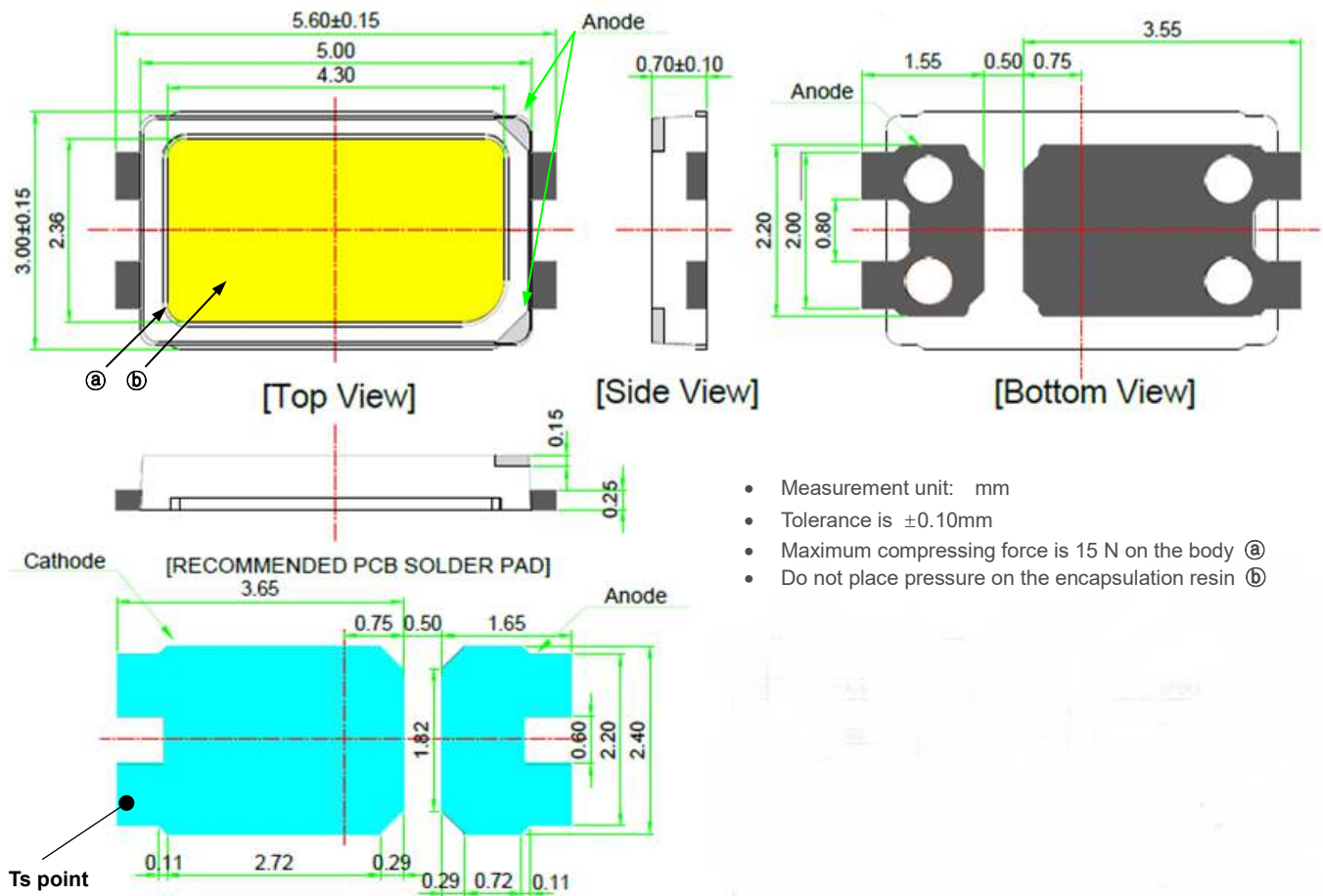

#### Notes:

- 1) This LED has built-in ESD protection device(s) connected in parallel to LED chip(s).
- 2)  $T_s$  point and measurement method:
  - ① Measure one point at the cathode pad, if necessary remove PSR of PCB to reach  $T_s$  point.
  - ② All pads must be soldered to the PCB to dissipate heat properly, otherwise the LED can be damaged.

#### Precautions:

- 1) Pressure on the LEDs will influence to the reliability of the LEDs. Precautions should be taken to avoid strong pressure on the LEDs. Do not put stress on the LEDs during heating.
- 2) Re-soldering should not be done after the LEDs have been soldered. If re-soldering is unavoidable, LED's characteristics should be carefully checked before and after such repair.
- 3) Do not stack assembled PCBs together. Since materials of LEDs is soft, abrasion between two PCB assembled with LED might cause catastrophic failure of the LEDs.

## 5. Reliability Test Items & Conditions

### a) Test Items

Test Item	Test Condition	Test Hour / Cycle	Sample No.	
High Temperature Life Test	85 °C, DC 200 mA	1000 h	22	
High Temperature Humidity Life Test	60 °C, 90 % RH, DC 200 mA	1000 h	22	
Powered Temperature Cycle Test	-40 °C / 10 min ↔ 85 °C / 10 min, sweep 20 min cycle on/off: each 5 min, DC 200 mA	100 cycles	22	
Thermal Cycle	-45 °C / 15 min ↔ 125 °C / 15 min → Hot plate 180 °C	500 cycles	100	
High Temperature Storage	120 °C	1000 h	11	
Low Temperature Storage	-40 °C	1000 h	11	
ESD (HBM)		R <sub>1</sub> : 10 MΩ R <sub>2</sub> : 1.5 kΩ C: 100 pF V: ±5 kV	5 times	30
ESD (MM)				
Vibration Test	20~2000~20 Hz, 200 m/s <sup>2</sup> , sweep 4 min X, Y, Z 3 direction, each 1 cycle	4 cycles	11	
Mechanical Shock Test	1500 g, 0.5 ms 3 shocks each X-Y-Z axis	5 cycles	11	

### b) Criteria for Judging the Damage

Item	Symbol	Test Condition (T <sub>s</sub> = 25 °C)	Limit	
			Min	Max
Forward Voltage	V <sub>F</sub>	I <sub>F</sub> = 65 mA	Init. Value * 0.9	Init. Value * 1.1
Luminous Flux	Φ <sub>v</sub>	I <sub>F</sub> = 65 mA	Init. Value * 0.7	Init. Value * 1.1

## 6. Soldering Conditions

### a) Reflow Conditions (Pb free)

Reflow frequency: 2 times max.

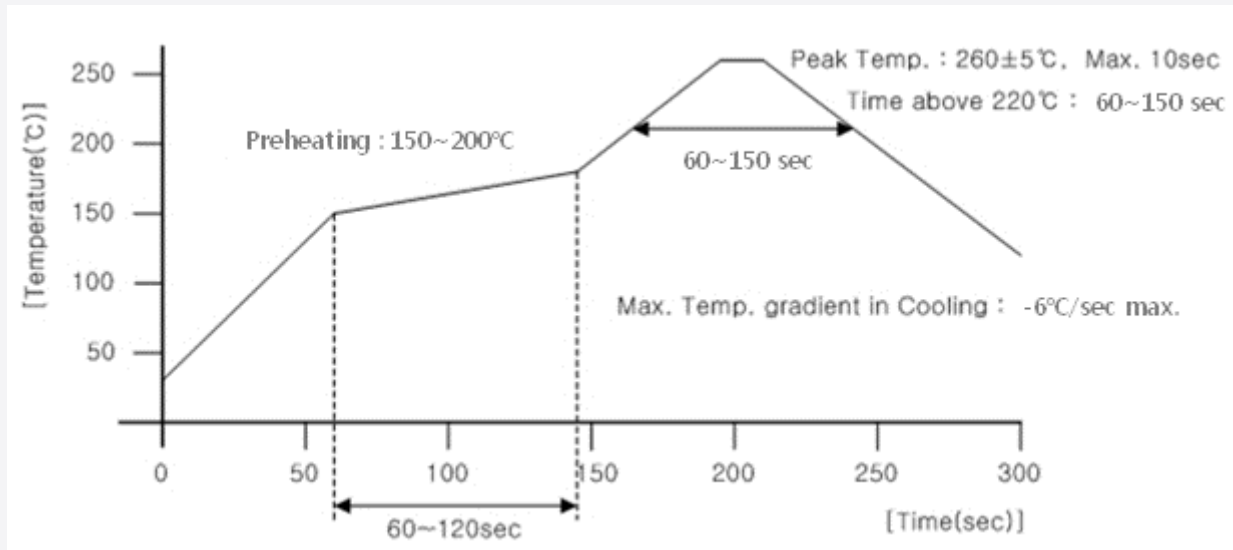

### b) Manual Soldering Conditions

Not more than 5 seconds @ max. 300 °C, under soldering iron.



## 7. Tape & Reel

### a) Taping Dimension

(unit: mm)

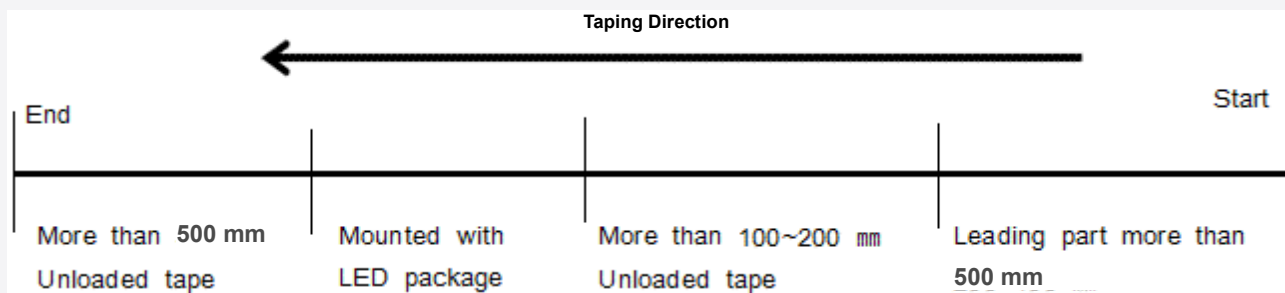
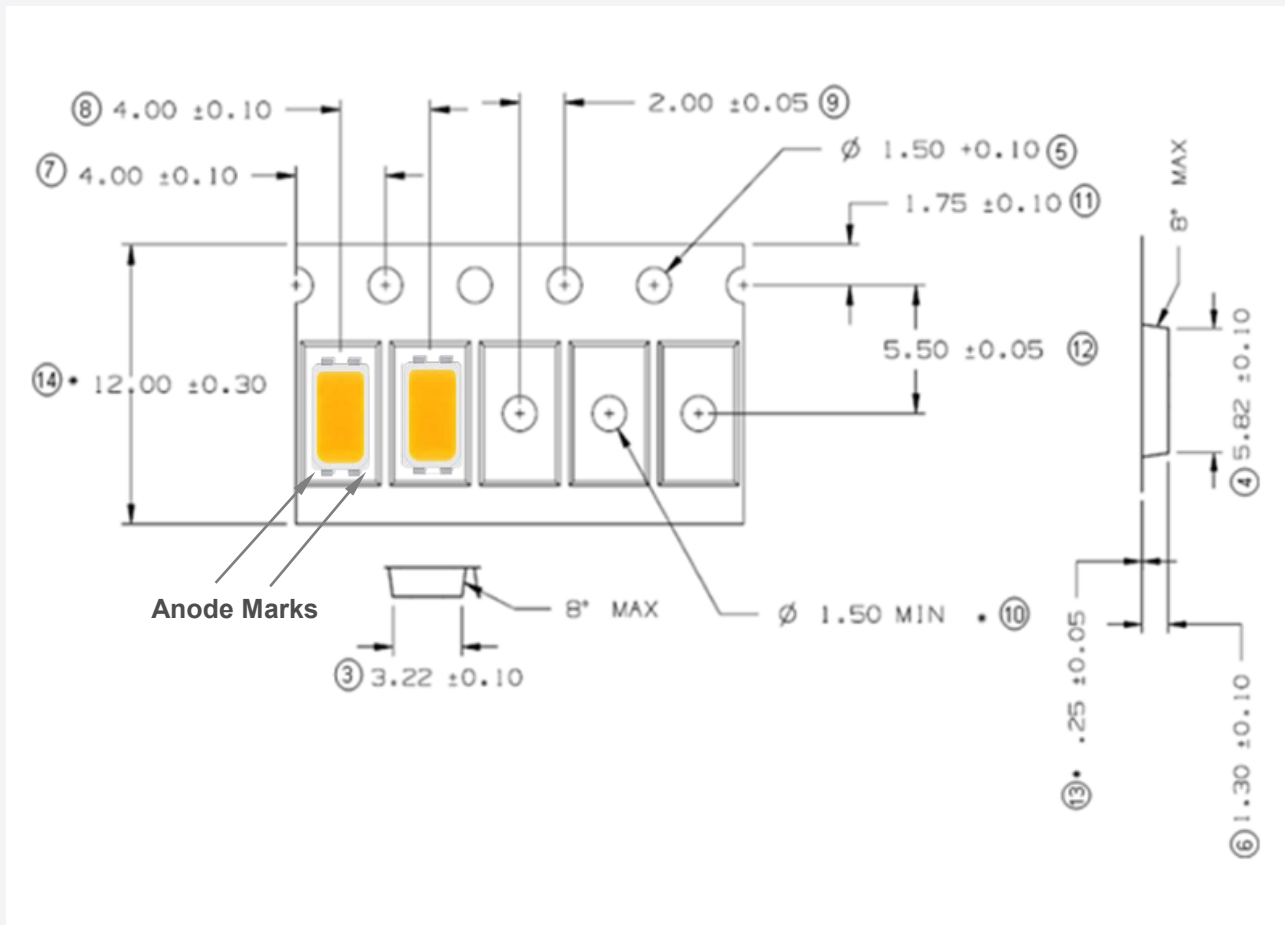

**b-1) Reel Dimension (Max 2,500 pcs)**

(unit: mm)

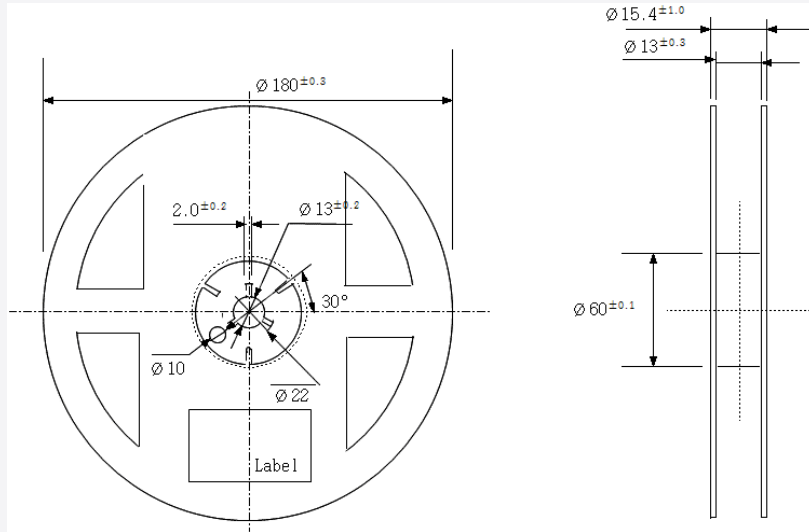

**b-2) Reel Dimension (Max 10,000 pcs)**

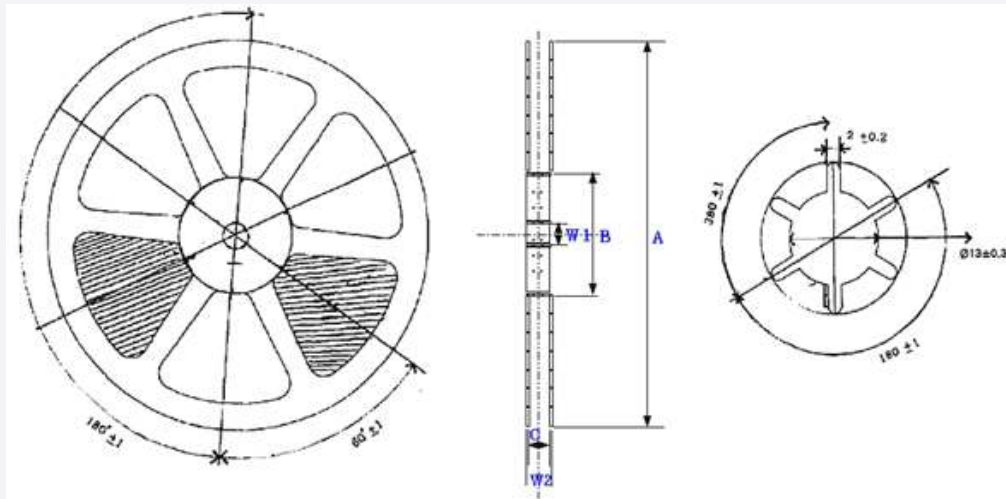

Symbol	A	B	C	W1	W2
Spec(mm)	Ø330±1	80±1	13±0.5	13±0.3	17.5±1

**Notes:**

- 1) Quantity: The quantity/reel is 2,500 pcs or 10,000 pcs
- 2) Cumulative Tolerance: Cumulative tolerance / 10 pitches is ±0.2 mm
- 3) Adhesion Strength of Cover Tape: Adhesion strength is 0.1-0.7 N when the cover tape is turned off from the carrier tape at 10° angle to the carrier tape
- 4) Packaging: P/N, Manufacturing data code no. and quantity are indicated on the aluminum packing bag

## 8. Label Structure

### a) Label Structure

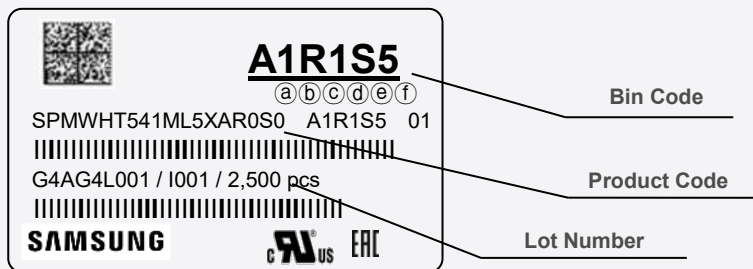

Note: Denoted bin code and product code above is only an example (see description on page 5)

Bin Code:

- ⒶⒷ: Forward Voltage bin (refer to page 10)
- ⒸⒹ: Chromaticity bin (refer to page 9-18)
- ⒺⒻ: Luminous Flux bin (refer to page 6)

### b) Lot Number

The lot number is composed of the following characters:



①②③④⑤⑥⑦⑧⑨ / ⒶⒷⒸ / 2,500 pcs

- ①, ② : Production site (GL : Tianjin, China, G3: Shenzhen, China, G4 : Guangzhou, China)
- ③ : Product state (A: Normal, B: Bulk, C: First Production, R: Reproduction, S: Sample)
- ④ : Year (F: 2021, G: 2022, H:2023, I: 2023...)
- ⑤ : Month (1~9, A, B, C)
- ⑥ : Day (1~9, A, B~V)
- ⑦⑧⑨ : Serial number (001 ~ 999)
- ⒶⒷⒸ : Reel number (001 ~ 999)

## 9. Packing Structure

### a-1) Packing Process (The quantity of PKG on the Reel to be Max 2,500pcs)

Reel



**A1R1S5**

SPMWHT541ML5XAR0S0 A1R1S5 01

|||||

G4AG4L001 / I001 / 2,500 pcs

|||||

**SAMSUNG**  

Aluminum Vinyl Packing Bag



**A1R1S5**

SPMWHT541ML5XAR0S0 A1R1S5 01

|||||

G4AG4L001 / I001 / 2,500 pcs

|||||

**SAMSUNG**  

Outer Box

Material: Paper (SW3B(B))

Type	Size (mm)			Note
	L	W	H	
7 inch S	245 ± 5	220 ± 5	86 ± 5	Up to 5 reels
7 inch L	245 ± 5	220 ± 5	182 ± 5	Up to 10 reels

① Side Label



**A1R1S5**

SPMWHT541ML5XAR0S0 A1R1S5 01

|||||

G4AG4L001 / I001 / 2,500 pcs

|||||

**SAMSUNG**  

(1P) Supplier Part Number: SPMWHT541ML5XAR0S0 	(Q) Quantity: 2,500 
(33P) Bin Code: A1R1S5 	(10D) Date Code: 2216 
(1T) Lot Number: G4AG4L001 	(4L) Country of Origin: CN 

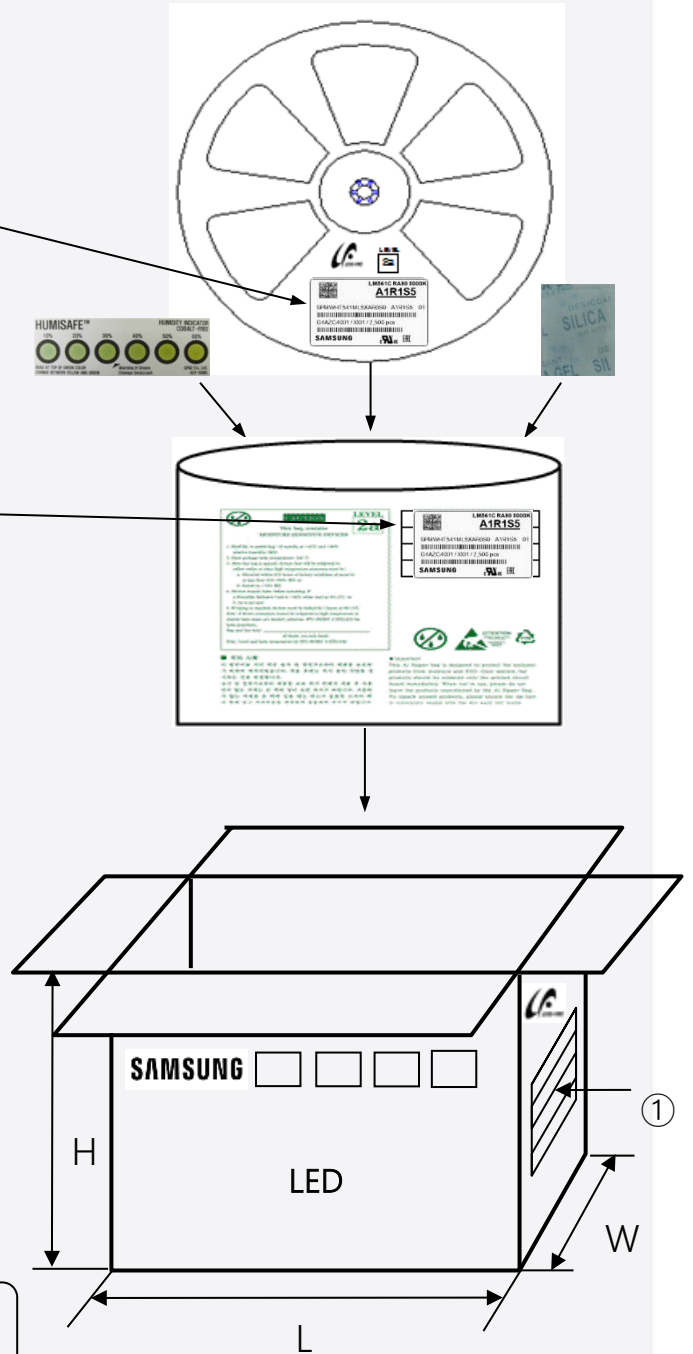

a-2) Packing Process (The quantity of PKG on the Reel to be Max 10,000pcs)

Reel

**A1R1S5**  
 SPMWHT541ML5XKR0S0 A1R1S5 01  
 G4AG4L001 / I001 / 10,000 pcs  
**SAMSUNG**

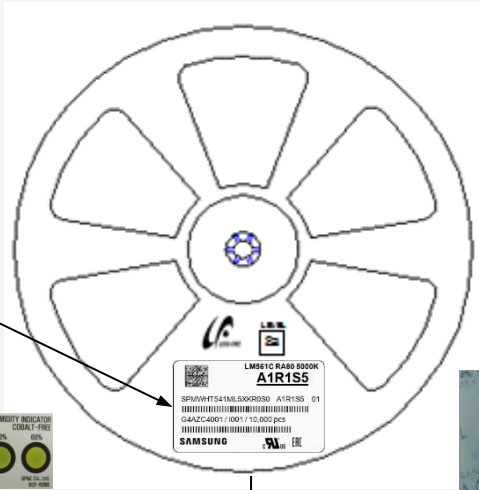

Aluminum Vinyl Packing Bag

**A1R1S5**  
 SPMWHT541ML5XKR0S0 A1R1S5 01  
 G4AG4L001 / I001 / 10,000 pcs  
**SAMSUNG**



Outer Box.

Material: Paper (SW3B(B))<sup>2</sup>

Type.	Size (mm).			Note.
	L.	W.	H.	
13 inch .	345 ± 5.	378 ± 5.	405 ± 5.	Up to 10 reels.

**A1R1S5**  
 SPMWHT541ML5XKR0S0 A1R1S5 01  
 G4AG4L001 / I001 / 150,000 pcs  
**SAMSUNG**

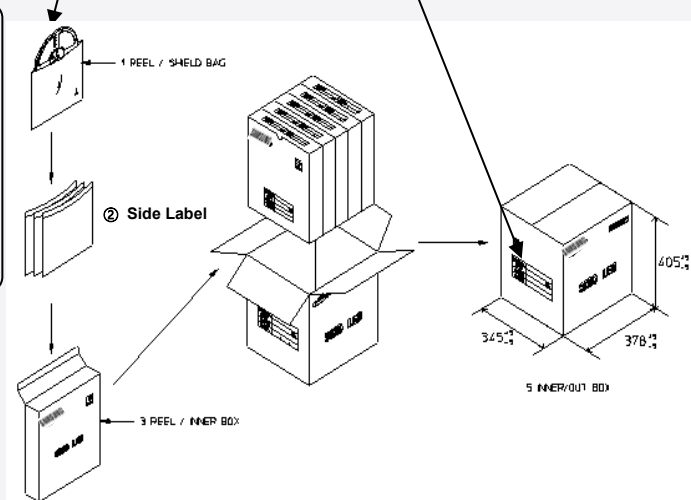

(1P) Supplier Part Number: SPMWHT541ML5XKR0S0 (Q) Quantity: 150,000  
 (33P) Bin Code: A1R1S5 (10D) Date Code: 2216  
 (1T) Lot Number: G4AG4L001 (4L) Country of Origin: CN

**b-1) Packing Process for kitting (The quantity of PKG on the Reel to be Max 2,500pcs)**

**Reel**

**Kitting 'A'**



**AZ◇WS5**  
 SPMWHT541ML5XA◇KS5 AZ◇WS5 01  
 G4AG4L001 / I001 / 2,500 pcs  
**SAMSUNG**  

**Kitting 'B'**



**AZ◇ZS5**  
 SPMWHT541ML5XA◇KS5 AZ◇ZS5 01  
 G4AG4L001 / I001 / 2,500 pcs  
**SAMSUNG**  

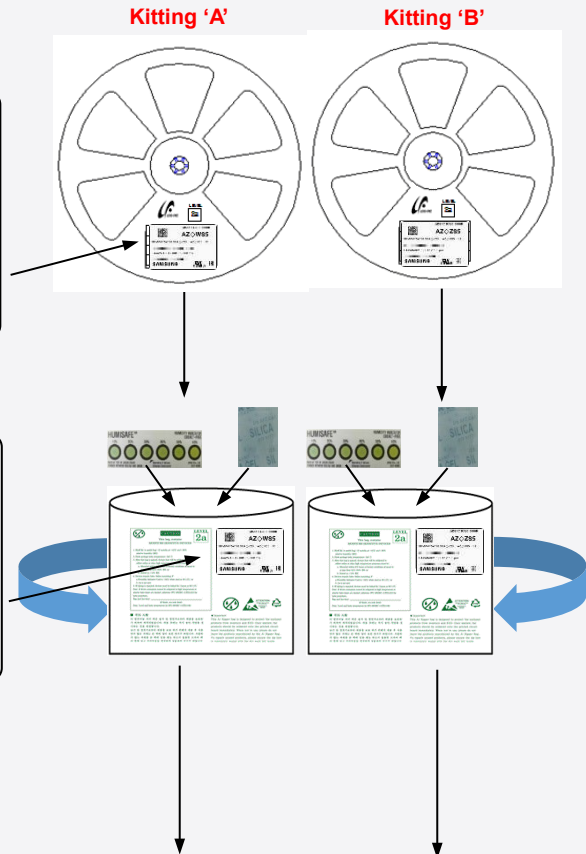

**Aluminum Vinyl Packing Bag**

**Kitting 'A'**



**AZ◇WS5**  
 SPMWHT541ML5XA◇KS5 AZ◇WS5 01  
 G4AG4L001 / I001 / 2,500 pcs  
**SAMSUNG**  

**Kitting 'B'**





**AZ◇ZS5**  
 SPMWHT541ML5XA◇KS5 AZ◇ZS5 01  
 G4AG4L001 / I001 / 2,500 pcs  
**SAMSUNG**  



Note: "◇" can be Nominal CCT code.



**Outer Box**



Material: Paper (SW3B(B))

Type	Size (mm)			Note
	L	W	H	
7 inch S	245 ± 5	220 ± 5	86 ± 5	Up to 5 reels
7 inch L	245 ± 5	220 ± 5	182 ± 5	Up to 10 reels



(1P) Supplier Part Number: SPMWHT541ML5XARKS5 (Q) Quantity: 12,500  
 

(33P) Bin Code: AZRWS5 (10D) Date Code: 2216  
 

(1T) Lot Number: G4AG4L001 (4L) Country of Origin: CN  
 

(1P) Supplier Part Number: SPMWHT541ML5XARKS5 (Q) Quantity: 12,500  
 

(33P) Bin Code: AZRZS5 (10D) Date Code: 2216  
 

(1T) Lot Number: G4AG4L001 (4L) Country of Origin: CN  
 

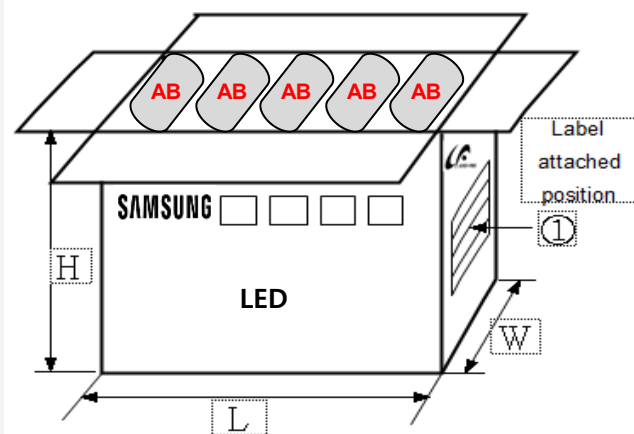

**b-2) Packing Process for kitting (The quantity of PKG on the Reel to be Max 10,000pcs)**

**Reel**

**Kitting 'A'**

**Kitting 'B'**

**Kitting 'A'**



**AZ◇WS5**

SPMWHT541ML5XK◇KS5 AZ◇WS5 01

|||||

G4AG4L001 / I001 / 10,000 pcs

|||||

**SAMSUNG**   

**Kitting 'B'**



**AZ◇ZS5**

SPMWHT541ML5XK◇KS5 AZ◇ZS5 01

|||||

G4AG4L001 / I001 / 10,000 pcs

|||||

**SAMSUNG**   

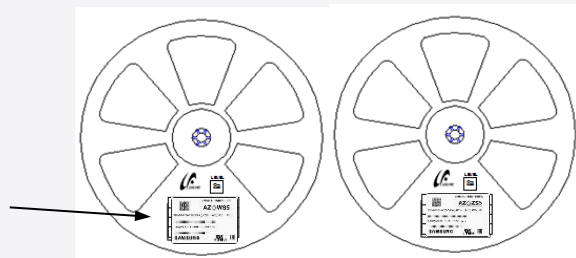

**Aluminum Vinyl Packing Bag**

**Kitting 'A'**



**AZ◇WS5**

SPMWHT541ML5XK◇KS5 AZ◇WS5 01

|||||

G4AG4L001 / I001 / 10,000 pcs

|||||

**SAMSUNG**   

**Kitting 'B'**



**AZ◇ZS5**

SPMWHT541ML5XK◇KS5 AZ◇ZS5 01

|||||

G4AG4L001 / I001 / 10,000 pcs

|||||

**SAMSUNG**   

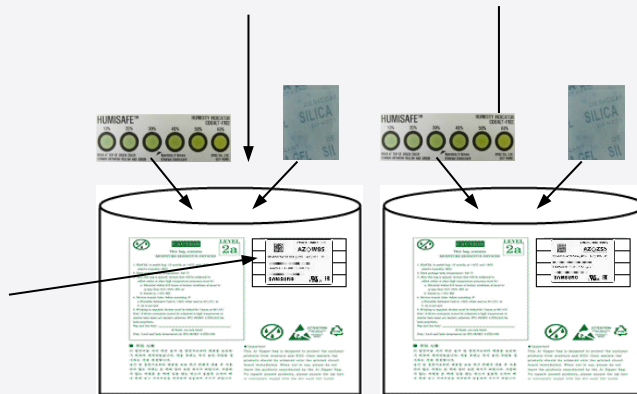

**Note:** "◇" can be Nominal CCT code.

**Outer Box**

Material: Paper (SW3B(B))

Type	Size (mm)			Note
	L	W	H	
13 inch	345 ± 5	378 ± 5	405 ± 5	Up to 10 reels

(1P) Supplier Part Number: SPMWHT541ML5XKRKS5 	(Q) Quantity: 10,000 
(33P) Bin Code: AZRWS5 	(10D) Date Code: 2216 
(1T) Lot Number: G4AG4L001 	(4L) Country of Origin : CN 

(1P) Supplier Part Number: SPMWHT541ML5XKRKS5 	(Q) Quantity : 2,500 
(33P) Bin Code: AZRWS5 	(10D) Date Code: 2216 
(1T) Lot Number: G4AG4L001 	(4L) Country of Origin: CN 

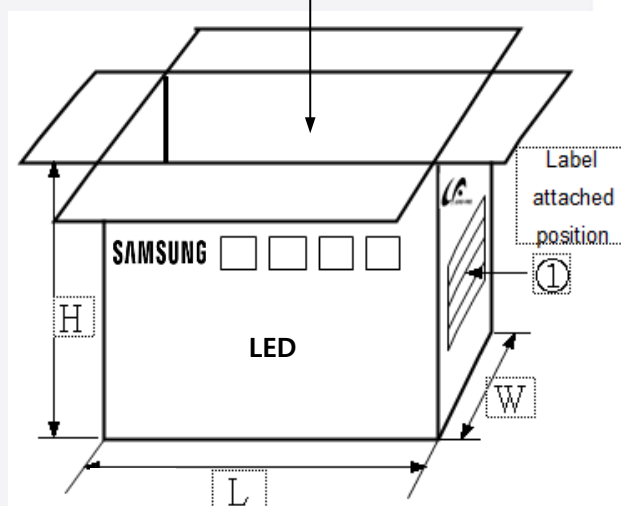
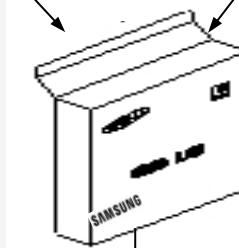



c) Aluminum Vinyl Packing Bag



**CAUTION**

This bag contains  
**MOISTURE SENSITIVE DEVICES**

**LEVEL**  
**2a**

1. Shelf life in sealed bag: 12 months at <40°C and <90% relative humidity (RH)
2. Peak package body temperature: 240 °C
3. After this bag is opened, devices that will be subjected to reflow solder or other high temperature processes must be:
  - a. Mounted within 672 hours at factory conditions of equal to or less than 30°C /60% RH, or
  - b. Stored at <10% RH
4. Devices require bake, before mounting, if:
  - a. Humidity Indicator Card is >60% when read at 23±5°C, or
  - b. 2a is not met.
5. If baking is required, devices must be baked for 10 ~ 24 hours at 60±5°C

Note: If device containers cannot be subjected to high temperature or shorter bake times are desired, reference IPC/JEDEC J-STD-033 for bake procedure.

Bag seal due date: \_\_\_\_\_  
(If blank, see code label)

Note: Level and body temperature by IPC/JEDEC J-STD-020



A1R1S5

SPMWHT541ML5XKR0S0 A1R1S5 01  
 G4AG4L001 / I001 / 10,000 pcs

**SAMSUNG** 



**ATTENTION**

OBserve PRECAUTIONS FOR HANDLINE ELECTROSTATIC SENSITIVE DEVICES



**■ 주의 사항**

이 알루미늄 지퍼 백은 습기 및 정전기로부터 제품을 보호하기 위하여 제작되었습니다. 개봉 후에는 즉시 솔더 작업을 실시하는 것을 권장합니다.

습기 및 정전기로부터 제품을 보호 하기 위해서 개봉 후 사용하지 않는 자재는 본 팩에 넣어 보관 하시기 바랍니다. 사용하지 않는 자재를 본 팩에 넣을 때는 반드시 동봉된 드라이 팩과 함께 넣고 지퍼부분을 완전하게 밀봉하여 주시기 바랍니다.

**■ Important**

This Al Zipper bag is designed to protect the enclosed products from moisture and ESD. Once opened, the products should be soldered onto the printed circuit board immediately. When not in use, please do not leave the products unprotected by the Al Zipper Bag. To repack unused products., please ensure the zip-lock is completely sealed with the dry pack left inside.

d) Silica Gel & Humidity Indicator Card inside Aluminum Vinyl Bag

(This image is for reference only. Silicagel and humidity indicator shapes may be different.)



**HUMISAFE™**

10%    20%    30%    40%    50%    60%



READ AT TOP OF GREEN COLOR CHANGE BETWEEN YELLOW AND GREEN

Warning If Green Change Desiccant

GP&E Co., Ltd. 6CF-60NS



## 10. Precautions in Handling & Use

- 1) For over-current protection, users are recommended to apply resistors connected in series with the LEDs to mitigate sudden change of the forward current caused by shift of forward voltage.
- 2) This device should not be used in any type of fluid such as water, oil, organic solvent, etc. When cleaning is required, IPA is recommended as the cleaning agent. Some solvent-based cleaning agent may damage the silicone resins used in the device.
- 3) When the device is in operation, the forward current should be carefully determined considering the maximum ambient temperature and corresponding junction temperature.
- 4) In order to obtain stable performance of LED, higher than 10% of the sorting current is recommended for operation.
- 5) LEDs must be stored in a clean environment. Shelf life of sealed bags is 12 months at temperature 0~40 °C, 0~90 % RH.
- 6) After storage bag is opened, device subjected to soldering, solder reflow, or other high temperature processes must be:
  - a. Mounted within 672 hours (28 days) at an assembly line with a condition of no more than 30 °C / 60 % RH\*Note 1, or
  - b. Mounted within 24 hours (1 day) at an assembly line with a condition of more than 30 °C / 70 % RH\*Note 2, or
  - c. Stored at <10 % RH.

\*Note 1, 2: IPC/JEDEC J-STD-033A, Recommended Equivalent Total Floor Life Table

Package Type and Body Thickness	Moisture Sensitivity Level	Maximum Percent Relative Humidity						Temperature
		40%	50%	60%	70%	80%	90%	
Body Thickness <2.1mm	Level 2a	∞	∞	28	1	1	1	30°C
		∞	∞	∞	2	1	1	25°C
		∞	∞	∞	2	2	1	20°C

- 7) Repack unused devices with anti-moisture packing, fold to close any opening and then store in a dry place.
- 8) Devices require baking before mounting, if humidity card reading is >60 % at 23 ± 5 °C.
- 9) Devices must be baked for 10~24 hours at 60 ± 5 °C, if baking is required.
- 10) The LEDs are sensitive to the static electricity and surge current. It is recommended to use a wrist band or anti-electrostatic glove when handling the LEDs. If voltage exceeding the absolute maximum rating is applied to LEDs, it may cause damage or even destruction to LED devices. Damaged LEDs may show some unusual characteristics such as increase in leakage current, lowered turn-on voltage, or abnormal lighting of LEDs at low current.
- 11) VOCs (Volatile Organic Compounds) can be generated from adhesives, flux, hardener or organic additives used in luminaires (fixtures). Transparent LED silicone encapsulant is permeable to those chemicals and they may lead to a discoloration of encapsulant when they exposed to heat or light. This phenomenon can cause a significant loss of light emitted (output) from the luminaires. In order to prevent these problems, we recommend users to know the physical properties of materials used in luminaires and they must be carefully selected.
- 12) Risk of sulfurization (or tarnishing)
 

The LED from Samsung uses a silver-plated lead frame and its surface color may change to black (or dark colored) when it is exposed to sulfur (S), chlorine (Cl) or other halogen compound. Sulfurization of lead frame may cause intensity degradation, change of chromaticity coordinates and, in extreme cases, open circuit. It requires caution. Due to possible sulfurization of lead frame, LED should not be used and stored together with oxidizing substances made of materials such as rubber, plain paper, lead solder cream, etc.

# Legal and additional information.

## [About Samsung Electronics Co., Ltd.](#)

Samsung inspires the world and shapes the future with transformative ideas and technologies.

The company is redefining the worlds of TVs, smartphones, wearable devices, tablets, digital appliances, network systems, and memory, system LSI, foundry and LED solutions.

For the latest news, please visit the Samsung Newsroom at [news.samsung.com](https://news.samsung.com).

"Samsung provides limited warranty for its LED products, the full text of which is

available at <https://www.samsung.com/led/support/warranties>"

Copyright © 2022 Samsung Electronics Co., Ltd. All rights reserved.

Samsung is a registered trademark of Samsung Electronics Co., Ltd.

Specifications and designs are subject to change without notice. Non-metric weights and measurements are approximate. All data were deemed correct at time of creation. Samsung is not liable for errors or omissions. All brand, product, service names and logos are trademarks and/or registered trademarks of their respective owners and are hereby recognized and acknowledged.

Samsung Electronics Co., Ltd.

95, Samsung 2-ro

Giheung-gu

Yongin-si, Gyeonggi-do, 446-711

KOREA

[www.samsungled.com](https://www.samsungled.com)

**SAMSUNG**