

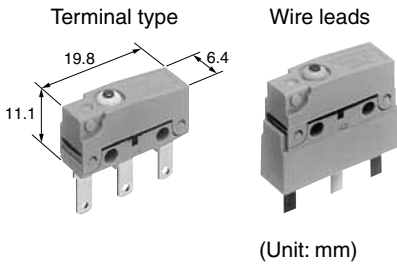

Subminiature Size Sealed Switches

ABS (BS) Turquoise Switches



RoHS compliant

FEATURES

- Subminiature size, High sealing performance sealed switches
- Elastomer double molding technology contribute to steady sealing quality
- Superior operating position precision

TYPICAL APPLICATIONS

- Automotive (detection of door opening and closing)
- Vacuum cleaner
- Air purifier
- Gas cooking range

ORDERING INFORMATION

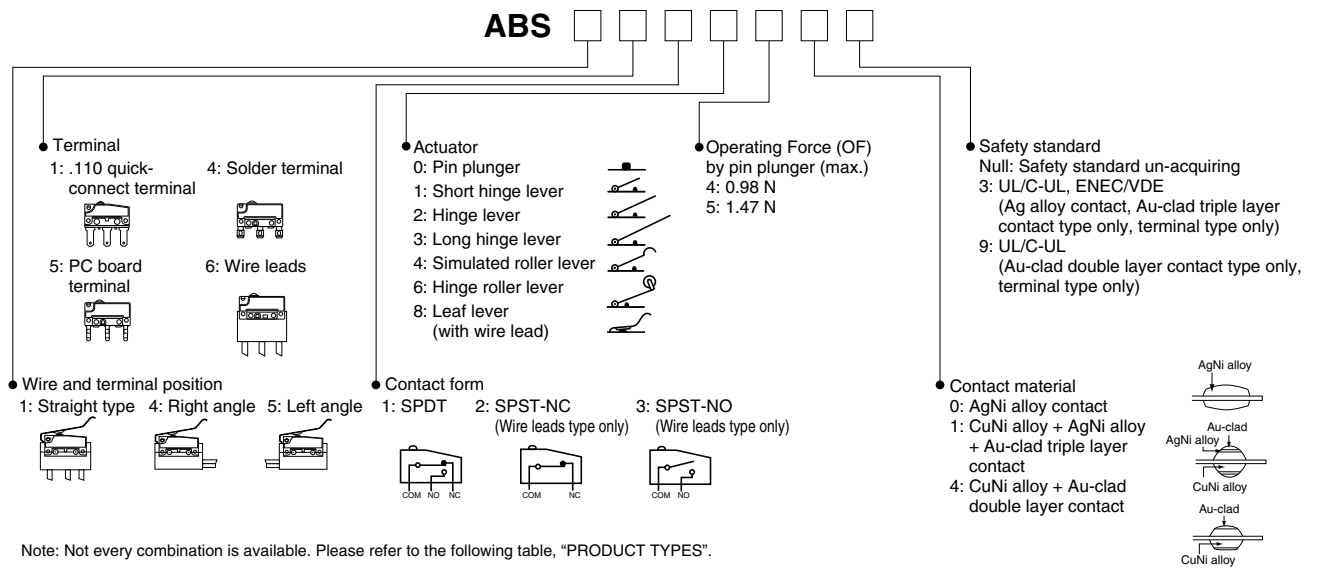

TERMINAL AND WIRE LEAD POSITION

■ PC board angle terminals



PC board right angle terminal (ABS4.....)



PC board left angle terminal (ABS5.....)

■ Wire leads position



Wire leads straight type (ABS1.....)



Wire leads right angle type (ABS4.....)



Wire leads left angle type (ABS5.....)

ABS (BS) Turquoise Switches

PRODUCT TYPES

(Color of plunger) AgNi alloy contact type: black, Au-clad triple layer contact type: dark red, Au-clad double layer contact type: green

■ Terminal type

1) AgNi alloy contact

Actuator	Operating Force OF Max.	.110 quick-connect terminal	Solder terminal	PC board terminal		
				Standard terminal	Right angle terminal	Left angle terminal
Pin plunger	0.98 N	ABS1110403	ABS1410403	ABS1510403	ABS4510403	ABS5510403
	1.47 N	ABS1110503	ABS1410503	ABS1510503	ABS4510503	ABS5510503
Short hinge lever	0.39 N	ABS1111403	ABS1411403	ABS1511403	ABS4511403	ABS5511403
	0.59 N	ABS1111503	ABS1411503	ABS1511503	ABS4511503	ABS5511503
Hinge lever	0.34 N	ABS1112403	ABS1412403	ABS1512403	ABS4512403	ABS5512403
	0.54 N	ABS1112503	ABS1412503	ABS1512503	ABS4512503	ABS5512503
Long hinge lever	0.25 N	ABS1113403	ABS1413403	ABS1513403	ABS4513403	ABS5513403
	0.44 N	ABS1113503	ABS1413503	ABS1513503	ABS4513503	ABS5513503
Simulated roller lever	0.34 N	ABS1114403	ABS1414403	ABS1514403	ABS4514403	ABS5514403
	0.54 N	ABS1114503	ABS1414503	ABS1514503	ABS4514503	ABS5514503
Roller lever	0.39 N	ABS1116403	ABS1416403	ABS1516403	ABS4516403	ABS5516403
	0.59 N	ABS1116503	ABS1416503	ABS1516503	ABS4516503	ABS5516503

2) CuNi alloy + AgNi alloy + Au-clad triple layer contact

Actuator	Operating Force OF Max.	.110 quick-connect terminal	Solder terminal	PC board terminal		
				Standard terminal	Right angle terminal	Left angle terminal
Pin plunger	0.98 N	ABS1110413	ABS1410413	ABS1510413	ABS4510413	ABS5510413
	1.47 N	ABS1110513	ABS1410513	ABS1510513	ABS4510513	ABS5510513
Short hinge lever	0.39 N	ABS1111413	ABS1411413	ABS1511413	ABS4511413	ABS5511413
	0.59 N	ABS1111513	ABS1411513	ABS1511513	ABS4511513	ABS5511513
Hinge lever	0.34 N	ABS1112413	ABS1412413	ABS1512413	ABS4512413	ABS5512413
	0.54 N	ABS1112513	ABS1412513	ABS1512513	ABS4512513	ABS5512513
Long hinge lever	0.25 N	ABS1113413	ABS1413413	ABS1513413	ABS4513413	ABS5513413
	0.44 N	ABS1113513	ABS1413513	ABS1513513	ABS4513513	ABS5513513
Simulated roller lever	0.34 N	ABS1114413	ABS1414413	ABS1514413	ABS4514413	ABS5514413
	0.54 N	ABS1114513	ABS1414513	ABS1514513	ABS4514513	ABS5514513
Roller lever	0.39 N	ABS1116413	ABS1416413	ABS1516413	ABS4516413	ABS5516413
	0.59 N	ABS1116513	ABS1416513	ABS1516513	ABS4516513	ABS5516513

3) CuNi alloy + Au-clad double layer contact

Actuator	Operating Force OF Max.	.110 quick-connect terminal	Solder terminal	PC board terminal		
				Standard terminal	Right angle terminal	Left angle terminal
Pin plunger	0.98 N	ABS1110449	ABS1410449	ABS1510449	ABS4510449	ABS5510449
	1.47 N	ABS1110549	ABS1410549	ABS1510549	ABS4510549	ABS5510549
Short hinge lever	0.39 N	ABS1111449	ABS1411449	ABS1511449	ABS4511449	ABS5511449
	0.59 N	ABS1111549	ABS1411549	ABS1511549	ABS4511549	ABS5511549
Hinge lever	0.34 N	ABS1112449	ABS1412449	ABS1512449	ABS4512449	ABS5512449
	0.54 N	ABS1112549	ABS1412549	ABS1512549	ABS4512549	ABS5512549
Long hinge lever	0.25 N	ABS1113449	ABS1413449	ABS1513449	ABS4513449	ABS5513449
	0.44 N	ABS1113549	ABS1413549	ABS1513549	ABS4513549	ABS5513549
Simulated roller lever	0.34 N	ABS1114449	ABS1414449	ABS1514449	ABS4514449	ABS5514449
	0.54 N	ABS1114549	ABS1414549	ABS1514549	ABS4514549	ABS5514549
Roller lever	0.39 N	ABS1116449	ABS1416449	ABS1516449	ABS4516449	ABS5516449
	0.59 N	ABS1116549	ABS1416549	ABS1516549	ABS4516549	ABS5516549

■ **3 wire leads type (SPDT)** Note: With safety standard type is not available

1) AgNi alloy contact

Actuator	Operating Force OF Max.	SPDT		
		Straight type	Right angle type	Left angle type
Pin plunger	0.98 N	ABS161040	ABS461040	ABS561040
	1.47 N	ABS161050	ABS461050	ABS561050
Short hinge lever	0.39 N	ABS161140	ABS461140	ABS561140
	0.59 N	ABS161150	ABS461150	ABS561150
Hinge lever	0.34 N	ABS161240	ABS461240	ABS561240
	0.54 N	ABS161250	ABS461250	ABS561250
Long hinge lever	0.25 N	ABS161340	ABS461340	ABS561340
	0.44 N	ABS161350	ABS461350	ABS561350
Simulated roller lever	0.34 N	ABS161440	ABS461440	ABS561440
	0.54 N	ABS161450	ABS461450	ABS561450
Roller lever	0.39 N	ABS161640	ABS461640	ABS561640
	0.59 N	ABS161650	ABS461650	ABS561650

2) CuNi alloy + AgNi alloy + Au-clad triple layer contact

Actuator	Operating Force OF Max.	SPDT		
		Straight type	Right angle type	Left angle type
Pin plunger	0.98 N	ABS161041	ABS461041	ABS561041
	1.47 N	ABS161051	ABS461051	ABS561051
Short hinge lever	0.39 N	ABS161141	ABS461141	ABS561141
	0.59 N	ABS161151	ABS461151	ABS561151
Hinge lever	0.34 N	ABS161241	ABS461241	ABS561241
	0.54 N	ABS161251	ABS461251	ABS561251
Long hinge lever	0.25 N	ABS161341	ABS461341	ABS561341
	0.44 N	ABS161351	ABS461351	ABS561351
Simulated roller lever	0.34 N	ABS161441	ABS461441	ABS561441
	0.54 N	ABS161451	ABS461451	ABS561451
Roller lever	0.39 N	ABS161641	ABS461641	ABS561641
	0.59 N	ABS161651	ABS461651	ABS561651

3) CuNi alloy + Au-clad double layer contact

Actuator	Operating Force OF Max.	SPDT		
		Straight type	Right angle type	Left angle type
Pin plunger	0.98 N	ABS161044	ABS461044	ABS561044
	1.47 N	ABS161054	ABS461054	ABS561054
Short hinge lever	0.39 N	ABS161144	ABS461144	ABS561144
	0.59 N	ABS161154	ABS461154	ABS561154
Hinge lever	0.34 N	ABS161244	ABS461244	ABS561244
	0.54 N	ABS161254	ABS461254	ABS561254
Long hinge lever	0.25 N	ABS161344	ABS461344	ABS561344
	0.44 N	ABS161354	ABS461354	ABS561354
Simulated roller lever	0.34 N	ABS161444	ABS461444	ABS561444
	0.54 N	ABS161454	ABS461454	ABS561454
Roller lever	0.39 N	ABS161644	ABS461644	ABS561644
	0.59 N	ABS161654	ABS461654	ABS561654

ABS (BS) Turquoise Switches

■ 2 wire leads type (SPST-NC) Note: With safety standard type is not available

1) AgNi alloy contact

Actuator	Operating Force OF Max.	SPST-NC		
		Straight type	Right angle type	Left angle type
Pin plunger	0.98 N	ABS162040	ABS462040	ABS562040
	1.47 N	ABS162050	ABS462050	ABS562050
Short hinge lever	0.39 N	ABS162140	ABS462140	ABS562140
	0.59 N	ABS162150	ABS462150	ABS562150
Hinge lever	0.34 N	ABS162240	ABS462240	ABS562240
	0.54 N	ABS162250	ABS462250	ABS562250
Long hinge lever	0.25 N	ABS162340	ABS462340	ABS562340
	0.44 N	ABS162350	ABS462350	ABS562350
Simulated roller lever	0.34 N	ABS162440	ABS462440	ABS562440
	0.54 N	ABS162450	ABS462450	ABS562450
Roller lever	0.39 N	ABS162640	ABS462640	ABS562640
	0.59 N	ABS162650	ABS462650	ABS562650

2) CuNi alloy + AgNi alloy + Au-clad triple layer contact

Actuator	Operating Force OF Max.	SPST-NC		
		Straight type	Right angle type	Left angle type
Pin plunger	0.98 N	ABS162041	ABS462041	ABS562041
	1.47 N	ABS162051	ABS462051	ABS562051
Short hinge lever	0.39 N	ABS162141	ABS462141	ABS562141
	0.59 N	ABS162151	ABS462151	ABS562151
Hinge lever	0.34 N	ABS162241	ABS462241	ABS562241
	0.54 N	ABS162251	ABS462251	ABS562251
Long hinge lever	0.25 N	ABS162341	ABS462341	ABS562341
	0.44 N	ABS162351	ABS462351	ABS562351
Simulated roller lever	0.34 N	ABS162441	ABS462441	ABS562441
	0.54 N	ABS162451	ABS462451	ABS562451
Roller lever	0.39 N	ABS162641	ABS462641	ABS562641
	0.59 N	ABS162651	ABS462651	ABS562651

3) CuNi alloy + Au-clad double layer contact

Actuator	Operating Force OF Max.	SPST-NC		
		Straight type	Right angle type	Left angle type
Pin plunger	0.98 N	ABS162044	ABS462044	ABS562044
	1.47 N	ABS162054	ABS462054	ABS562054
Short hinge lever	0.39 N	ABS162144	ABS462144	ABS562144
	0.59 N	ABS162154	ABS462154	ABS562154
Hinge lever	0.34 N	ABS162244	ABS462244	ABS562244
	0.54 N	ABS162254	ABS462254	ABS562254
Long hinge lever	0.25 N	ABS162344	ABS462344	ABS562344
	0.44 N	ABS162354	ABS462354	ABS562354
Simulated roller lever	0.34 N	ABS162444	ABS462444	ABS562444
	0.54 N	ABS162454	ABS462454	ABS562454
Roller lever	0.39 N	ABS162644	ABS462644	ABS562644
	0.59 N	ABS162654	ABS462654	ABS562654

■ **2 wire leads type (SPST-NO)** Note: With safety standard type is not available

1) AgNi alloy contact

Actuator	Operating Force OF Max.	SPST-NO		
		Straight type	Right angle type	Left angle type
Pin plunger	0.98 N	ABS163040	ABS463040	ABS563040
	1.47 N	ABS163050	ABS463050	ABS563050
Short hinge lever	0.39 N	ABS163140	ABS463140	ABS563140
	0.59 N	ABS163150	ABS463150	ABS563150
Hinge lever	0.34 N	ABS163240	ABS463240	ABS563240
	0.54 N	ABS163250	ABS463250	ABS563250
Long hinge lever	0.25 N	ABS163340	ABS463340	ABS563340
	0.44 N	ABS163350	ABS463350	ABS563350
Simulated roller lever	0.34 N	ABS163440	ABS463440	ABS563440
	0.54 N	ABS163450	ABS463450	ABS563450
Roller lever	0.39 N	ABS163640	ABS463640	ABS563640
	0.59 N	ABS163650	ABS463650	ABS563650

2) CuNi alloy + AgNi alloy + Au-clad triple layer contact

Actuator	Operating Force OF Max.	SPST-NO		
		Straight	Right angle	Left angle
Pin plunger	0.98 N	ABS163041	ABS463041	ABS563041
	1.47 N	ABS163051	ABS463051	ABS563051
Short hinge lever	0.39 N	ABS163141	ABS463141	ABS563141
	0.59 N	ABS163151	ABS463151	ABS563151
Hinge lever	0.34 N	ABS163241	ABS463241	ABS563241
	0.54 N	ABS163251	ABS463251	ABS563251
Long hinge lever	0.25 N	ABS163341	ABS463341	ABS563341
	0.44 N	ABS163351	ABS463351	ABS563351
Simulated roller lever	0.34 N	ABS163441	ABS463441	ABS563441
	0.54 N	ABS163451	ABS463451	ABS563451
Roller lever	0.39 N	ABS163641	ABS463641	ABS563641
	0.59 N	ABS163651	ABS463651	ABS563651

3) CuNi alloy + Au-clad double layer contact

Actuator	Operating Force OF Max.	SPST-NO		
		Straight	Right angle	Left angle
Pin plunger	0.98 N	ABS163044	ABS463044	ABS563044
	1.47 N	ABS163054	ABS463054	ABS563054
Short hinge lever	0.39 N	ABS163144	ABS463144	ABS563144
	0.59 N	ABS163154	ABS463154	ABS563154
Hinge lever	0.34 N	ABS163244	ABS463244	ABS563244
	0.54 N	ABS163254	ABS463254	ABS563254
Long hinge lever	0.25 N	ABS163344	ABS463344	ABS563344
	0.44 N	ABS163354	ABS463354	ABS563354
Simulated roller lever	0.34 N	ABS163444	ABS463444	ABS563444
	0.54 N	ABS163454	ABS463454	ABS563454
Roller lever	0.39 N	ABS163644	ABS463644	ABS563644
	0.59 N	ABS163654	ABS463654	ABS563654

ABS (BS) Turquoise Switches

■ Immersion protected type (3 wire leads type SPDT) Note: With safety standard type is not available

• Leaf lever type

1) AgNi alloy

Actuator	Operating force Max.	SPDT		
		Wire position		
		Straight	Right angle	Left angle
Leaf lever	0.88 N	ABS161840	ABS461840	ABS561840
	1.08 N	ABS161850	ABS461850	ABS561850

2) Au-clad triple layer

Actuator	Operating force Max.	SPDT		
		Wire position		
		Straight	Right angle	Left angle
Leaf lever	0.88 N	ABS161841	ABS461841	ABS561841
	1.08 N	ABS161851	ABS461851	ABS561851

3) Au-clad double layer

Actuator	Operating force Max.	SPDT		
		Wire position		
		Straight	Right angle	Left angle
Leaf lever	0.88 N	ABS161844	ABS461844	ABS561844
	1.08 N	ABS161854	ABS461854	ABS561854

■ Immersion protected type (2 wire leads type SPST-NC) Note: With safety standard type is not available

• Leaf lever type

1) AgNi alloy

Actuator	Operating force Max.	SPST-NC		
		Wire position		
		Straight	Right angle	Left angle
Leaf lever	0.88 N	ABS162840	ABS462840	ABS562840
	1.08 N	ABS162850	ABS462850	ABS562850

2) Au-clad triple layer

Actuator	Operating force Max.	SPST-NC		
		Wire position		
		Straight	Right angle	Left angle
Leaf lever	0.88 N	ABS162841	ABS462841	ABS562841
	1.08 N	ABS162851	ABS462851	ABS562851

3) Au-clad double layer

Actuator	Operating force Max.	SPST-NC		
		Wire position		
		Straight	Right angle	Left angle
Leaf lever	0.88 N	ABS162844	ABS462844	ABS562844
	1.08 N	ABS162854	ABS462854	ABS562854

■ Immersion protected type (2 wire leads type SPST-NO) Note: With safety standard type is not available

• Leaf lever type

1) AgNi alloy

Actuator	Operating force Max.	SPST-NO		
		Wire position		
		Straight	Right angle	Left angle
Leaf lever	0.88 N	ABS163840	ABS463840	ABS563840
	1.08 N	ABS163850	ABS463850	ABS563850

2) Au-clad triple layer

Actuator	Operating force Max.	SPST-NO		
		Wire position		
		Straight	Right angle	Left angle
Leaf lever	0.88 N	ABS163841	ABS463841	ABS563841
	1.08 N	ABS163851	ABS463851	ABS563851

* Safety standard: Please refer to "Ordering information".

3) Au-clad double layer

Actuator	Operating force Max. gf	SPST-NO		
		Wire position		
		Straight	Right angle	Left angle
Leaf lever	0.88 N	ABS163844	ABS463844	ABS563844
	1.08 N	ABS163854	ABS463854	ABS563854

* Safety standard: Please refer to "Ordering information".

SPECIFICATIONS

■ Contact rating

Item	Specifications			
Contact specifications	AgNi alloy contact type Plunger color: Black		Au-clad contact type	
			Triple layer contact type Plunger color: Red	Double layer contact type Plunger color: Green
Load style	Resistive load	Inductive load ($\cos\phi \approx 0.7$)	Resistive load	Resistive load
125 V AC	2 A	2 A	0.1 A	—
250 V AC	2 A	2 A	0.1 A	—
30 V DC	2 A	2 A	0.1 A	0.1 A
125 V DC	0.4 A	0.05 A	—	—

Note: Inductive load with direct current is 7 ms time constant or less.

• Low-level circuit rating (Au-clad contact type)

Rated voltage	Resistive load
6 V DC	5 mA
12 V DC	2 mA
24 V DC	1 mA

- Recommended contact material chart classified by load voltage & current (reference)

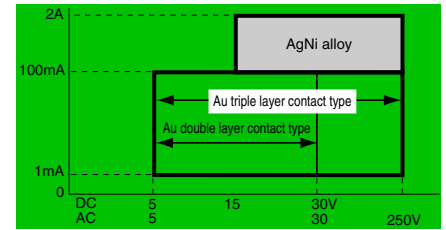

Note: If the contact is being used in the constant low-level circuit load range, the Au-clad double layer contact is recommended. If there is a danger of the current being less than 0.5 A, for instance if the contact is being turned on and off, the Au-clad triple layer contact type is recommended. The diagram above is intended as a reference. Please use the product within the rated voltage and current.

■ Characteristics

Item	Specifications	
Expected life	Mechanical life (OT: Specified value)	Leaf lever: Min. 5×10^5 (at 60 cpm), Other types: Min. 5×10^6 (at 60 cpm)
	Electrical life (OT: Max.)	AgNi alloy contact type
Au-clad contact type		Min. 2×10^5 (at 20 cpm) (at rated load)
Insulation resistance	Min. 100 M Ω (at 500 V DC insulation resistance meter)	
Dielectric strength	Between non-continuous terminals	1,000 Vrms
	Between each terminal and other exposed metal parts	1,500 Vrms
	Between each terminal and ground	1,500 Vrms
Vibration resistance (Pin plunger type)	10 to 55 Hz at single amplitude of 0.75 mm (Contact opening Max. 1 msec.)	
Shock resistance (Pin plunger type)	Min. 294 m/s ² (Contact opening Max. 1 msec.)	
Contact resistance (Initial)	AgNi alloy contact type	Terminal type Max. 50 m Ω Wire leads: Max. 100 m Ω (by voltage drop 1 A 6 to 8 V DC)
	Au-clad contact type	Terminal type: Max. 100 m Ω Wire leads: Max. 150 m Ω (by voltage drop 0.1 A 6 to 8 V DC)
Allowable operating speed (at no load)	0.1 to 500 mm/sec.	
Max. operating cycle rate (at no load)	120 cpm	
Ambient temperature	-40°C to +85°C	
Unit weight	Approx. 2 g (Terminal type)	
Protection grade	IP67 (except exposed terminal part of terminal type)	

■ Operating characteristics

Type of actuator	8th digit of Part No.	Operating Force OF, Max.	Release Force RF, Min.	Pretravel PT, Max.	Movement Differential MD, Max.	Overtravel OT, Min.	Operating Position OP
Pin plunger	4	0.98N	0.15N	0.6mm	0.1mm	0.4mm	8.4 \pm 0.3mm
	5	1.47N	0.20N	0.6mm	0.1mm	0.4mm	8.4 \pm 0.3mm
Short hinge lever	4	0.39N	0.034N	2.5mm	0.5mm	0.8mm	8.8 \pm 0.8mm
	5	0.59N	0.039N	2.5mm	0.5mm	0.8mm	8.8 \pm 0.8mm
Hinge lever	4	0.34N	0.029N	2.8mm	0.8mm	1.2mm	8.8 \pm 0.8mm
	5	0.54N	0.034N	2.8mm	0.8mm	1.2mm	8.8 \pm 0.8mm
Long hinge lever	4	0.25N	0.025N	3.5mm	1.0mm	1.6mm	8.8 \pm 1.2mm
	5	0.44N	0.029N	3.5mm	1.0mm	1.6mm	8.8 \pm 1.2mm
Simulated roller lever	4	0.34N	0.029N	2.8mm	0.8mm	1.2mm	11.65 \pm 0.8mm
	5	0.54N	0.034N	2.8mm	0.8mm	1.2mm	11.65 \pm 0.8mm
Roller lever	4	0.39N	0.034N	2.5mm	0.5mm	0.8mm	14.5 \pm 0.8mm
	5	0.59N	0.039N	2.5mm	0.5mm	0.8mm	14.5 \pm 0.8mm
Leaf lever	4	0.88N	0.17N	4.5mm	1.0mm	2.5mm	14.5 \pm 1.5mm
	5	1.08N	0.20N	4.5mm	1.0mm	2.5mm	14.5 \pm 1.5mm

ABS (BS) Turquoise Switches

DIMENSIONS

(Unit: mm) General tolerance: ± 0.25

The CAD data of the products with a **CAD Data** mark can be downloaded from: <http://industrial.panasonic.com/ac/e/>

■ .110 quick-connect terminal

Pin plunger

CAD Data

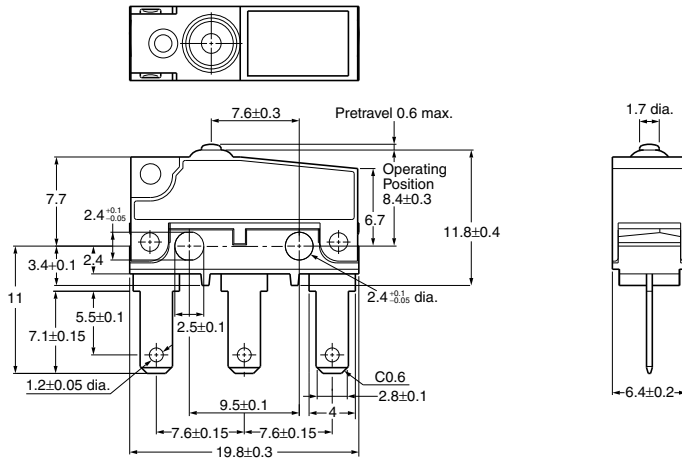

Pretravel PT, Max.	0.6mm	
Movement Differential MD, Max.	0.1mm	
Overtravel OT, Min.	0.4mm	
Operating Position OP	Distance from mounting hole	8.4±0.3mm
	Distance from stand-off	11.8±0.4mm

Short hinge lever

CAD Data

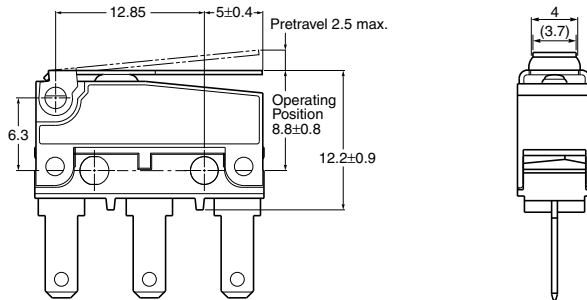

Pretravel PT, Max.	2.5mm	
Movement Differential MD, Max.	0.5mm	
Overtravel OT, Min.	0.8mm	
Operating Position OP	Distance from mounting hole	8.8±0.8mm
	Distance from stand-off	12.2±0.9mm

Hinge lever

CAD Data

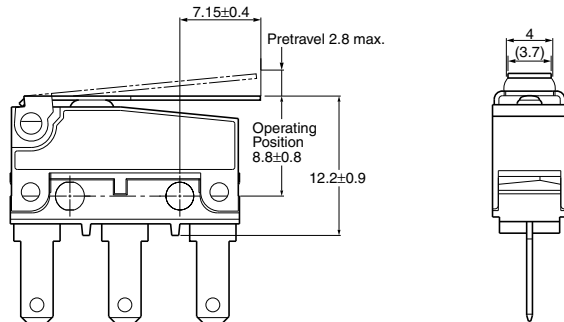

Pretravel PT, Max.	2.8mm	
Movement Differential MD, Max.	0.8mm	
Overtravel OT, Min.	1.2mm	
Operating Position OP	Distance from mounting hole	8.8±0.8mm
	Distance from stand-off	12.2±0.9mm

Long hinge lever

CAD Data

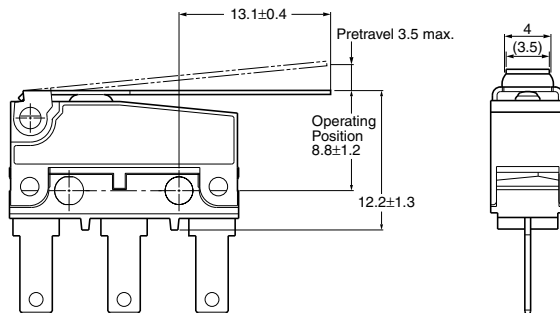
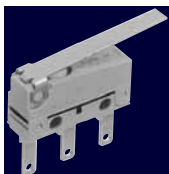

Pretravel PT, Max.	3.5mm	
Movement Differential MD, Max.	1.0mm	
Overtravel OT, Min.	1.6mm	
Operating Position OP	Distance from mounting hole	8.8±1.2mm
	Distance from stand-off	12.2±1.3mm

Simulated roller lever

CAD Data

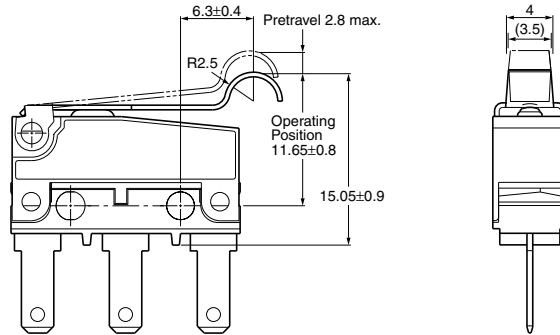
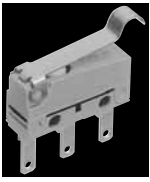

Pretravel PT, Max.		2.8mm
Movement Differential MD, Max.		0.8mm
Overtravel OT, Min.		1.2mm
Operating Position OP	Distance from mounting hole	11.65±0.8mm
	Distance from stand-off	15.05±0.9mm

Roller lever

CAD Data

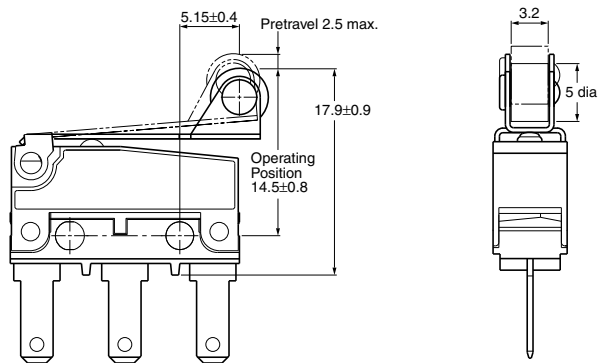

Pretravel PT, Max.		2.5mm
Movement Differential MD, Max.		0.5mm
Overtravel OT, Min.		0.8mm
Operating Position OP	Distance from mounting hole	14.5±0.8mm
	Distance from stand-off	17.9±0.9mm

Solder terminal

CAD Data

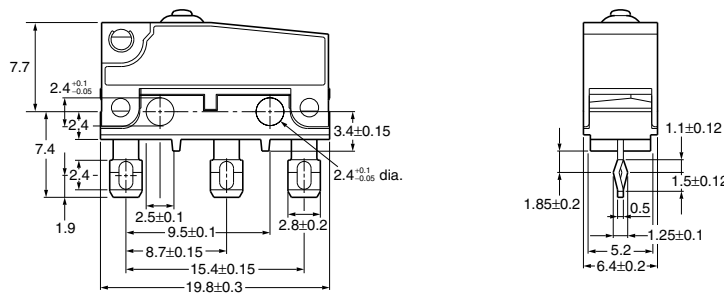
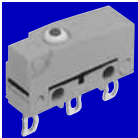

Note: Dimensions of the actuator types are the same as those of corresponding .110 quick-connect terminal types.

PC board terminal

Straight type

CAD Data

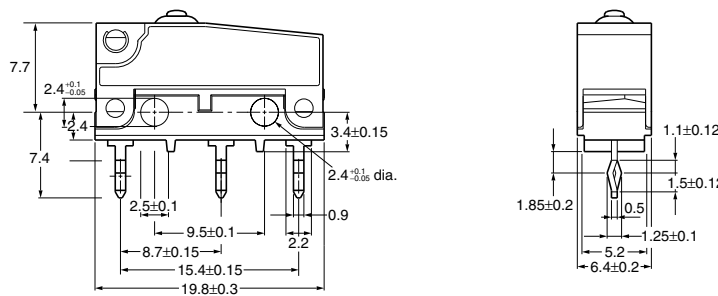

PC board pattern

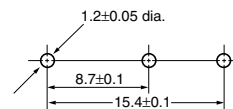

Note: Dimensions of the actuator types are the same as those of corresponding .110 quick-connect terminal types.

ABS (BS) Turquoise Switches

■ PC board right angle terminal

CAD Data

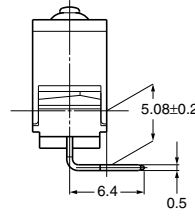
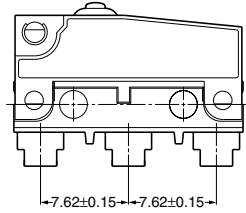

PC board pattern

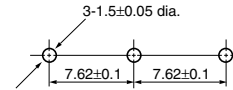

Note: Dimensions of the actuator types are the same as those of corresponding .110 quick-connect terminal types.

■ PC board left angle terminal

CAD Data

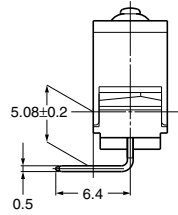
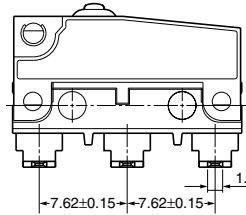

PC board pattern

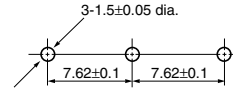

Note: Dimensions of the actuator types are the same as those of corresponding .110 quick-connect terminal types.

■ Wire leads

Wire leads straight type

CAD Data



SPDT



SPST-NC

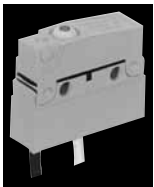

SPST-NO

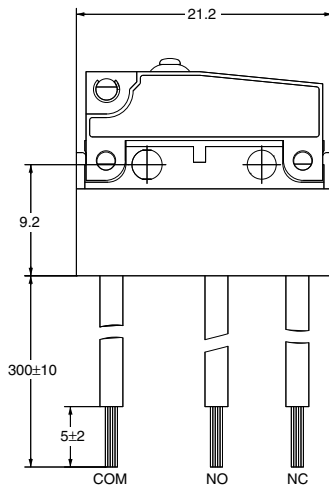

Thickness of the wire lead: 0.5 mm²

Color of the wire lead:

COM... Black

NO White

NC Red

Note: Other dimensions are the same as those of .110 quick-connect terminal types.

Dimensions of the actuator types are the same as those of corresponding .110 quick-connect terminal types.

Wire leads right angle type

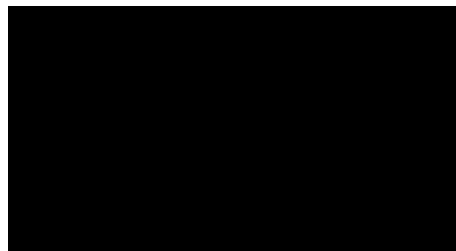

Wire leads left angle type

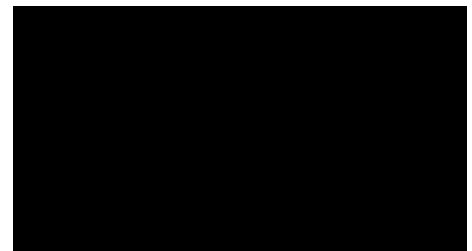

Note: For wire leads right angle type and left angle type, the wire lead is changed to UL compliant (AWG20). Color of the wire is same as straight type.

■ Wire leads leaf lever type

Wire leads straight type

CAD Data

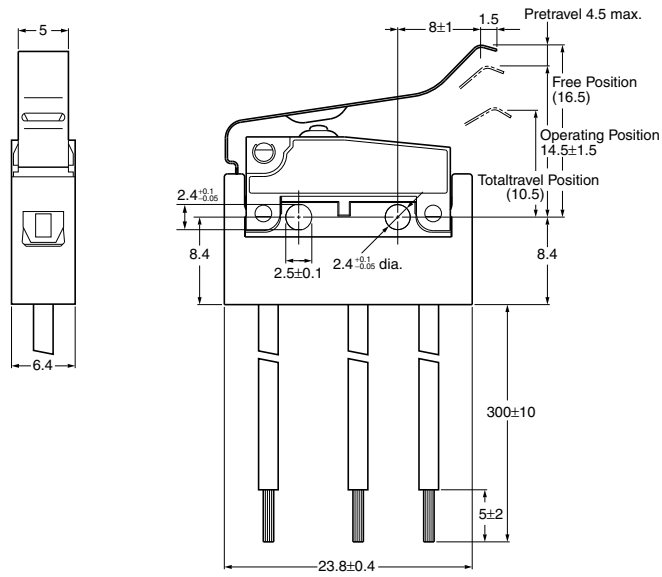
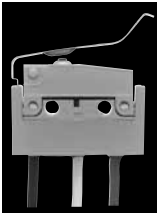

Thickness of the wire lead: 0.5 mm²

Color of the wire lead:

COM... Black

NO White

NC Red

Wire leads right angle type

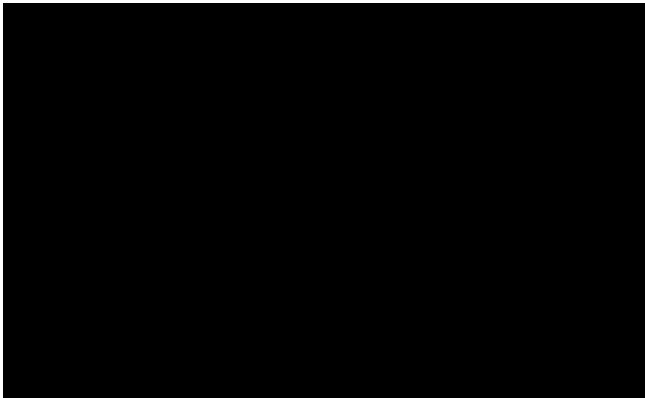

Wire leads left angle type

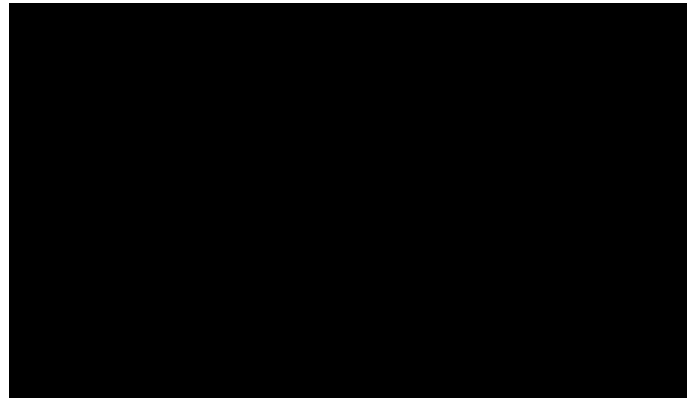

Note: For wire leads right angle type and left angle type, the wire lead is changed to UL compliant (AWG20). Color of the wire is same as straight type.

Notes for Turquoise Switches (BJ, BS, BV type)

CAUTIONS FOR USE (Common for BJ, BS and BV types)

■ Fastening of the switch body

1) Fasten the switch body onto a smooth surface using the correct screw as shown in the chart below and tighten it with the prescribed torque.

The switch case may deform depending on the type of screw (screw head diameter, etc.), the size of the washer, and the use or non-use of a washer. Therefore, please confirm the appropriate torque of actual conditions. Also, it is recommended that adhesive be applied to lock the screws to prevent loosening of the screws. When doing so, please be careful not let any adhesive get inside the switch.

	Screws	Tightening torque
ABJ (BJ) switches	M1.2	Not more than 0.098N·m
	M2.3	Not more than 0.29N·m
	M3.0	Not more than 0.29N·m
ABS (BS) switches	M2.3	Not more than 0.29N·m
ABV (BV) switches	M3.0	Not more than 0.49N·m

2) Fixed pin type

To secure the switch unit, thermally crimp or press-fit the mounting pins. If the pins are to be press-fitted, install a guide on the opposite surface to the mounting pins to prevent them from slipping out of position and developing play.

3) Be sure to maintain adequate insulating clearance between each terminal and ground.

4) The positioning of the switch should be such that direct force is not applied to the pushbutton or actuator in its free position. The operating force to the pushbutton should only be applied in a perpendicular direction.

5) The standard value of overtravel used should be within the range of 70% to 100% of the rated OT value.

6) When soldering the BV type turquoise switch or the immersion protected type of the BJ and BS type switches, the sealing material sometimes forms a lump or bulge at the base of the terminal or lead. Be sure to allow enough space for this when attaching the switch.

■ Soldering operations

1) Manual soldering: Perform soldering in less than 3 seconds with maximum 350°C iron. Care should be taken not to apply force to the terminals during soldering. We recommend a soldering iron with temperature adjustment in order to prevent poor quality soldering.

Please consult us if you intend to use a soldering iron of 60 W or higher.

2) Terminal portions should not be moved within 1 minute after soldering.

	Soldering time
ABJ (BJ) switches	Within 3 seconds
ABS (BS) switches	Within 3 seconds
ABV (BV) switches	Within 5 seconds

■ Selection of the switch

Allow for up to $\pm 20\%$ variation of the specified characteristics values to compensate for long term operational wear of the switch in your design.

■ Cautions regarding use

1) When switching inductive loads (relays, solenoids, buzzers, etc.), an arc absorbing circuit is recommended to protect the contacts.

2) If switching of the contact is synchronized with the phase of the AC power, reduced electrical life or welded contact may occur. Therefore, test the switch while it is operating under actual loads for this condition. If found, you may wish to take corrective action in your design.

3) In the slow or high speed operating condition, the electrical life might be greatly reduced depending upon the switching load. Please consult us before use.

4) Using lever type in do not condition, there is the concern that the flexible part may be impeded and return movement may not be possible. In this situation take the following precautions:

- Select a product of higher OF or use a leaf type lever.
- Attach a protective cover to the lever.

5) If the leaf lever type switch is excessively pushed (pushed further than the operational limit position) or switching is done at high speed or is accompanied by the impact, the lever will break. Please be careful. Also, be careful with the short roller lever type ABV (BV) switch as improper return may result from pressing too much.

■ Protection from dust, water and corrosive gas

1) The pin button and the space around the body cap Turquoise switches are sealed with elastic material, the terminal portion is integrally molded. This prevents dust entry and protects the switch against corrosive gases. Wireleaded types are recommended for applications subject to water or oil splash. However, avoid soaking these immersion protected types in oil or water, because those types are not of completely oil tight construction.

2) Switch operation or rapid temperature change while water droplets are on the switch may cause the water invasion inside the switch because of breathing action on condensation. Especially do not use switch in a bath.

If sources of silicon gas are existing in the vicinity of the switch (silicon rubber, silicon oil, silicon coating, and silicon filler, etc.), silicon gas (low molecular siloxane, etc.) will be emitted and it will get into the product due to the permeability of the plastic. If the switch is used or stored in such an environment, silicon compound might generate on the contacts, cause the and faulty contacting. Therefore, please do not use sources that can emit silicon gas in the vicinity of the switch.

Do not use in areas where flammable or explosive gases from gasoline and thinner, etc., may be present.

Notes for Turquoise Switches (BJ, BS, BV type)

• Dust protection test

Test conditions: The talcum powder used shall be able to pass through a square- meshed sieve the nominal wire diameter of 7 μm . The amount of talcum powder to be used is 2 kg per cubic metre of the test chamber volume. The duration of the test is 8 hours.

No damage observed after the test.

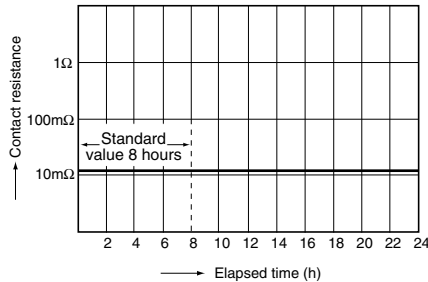

• Waterproof test

Test conditions: Immersion protected IP67 switches ...
Submerge at 1 m below the water surface for 30 minutes.

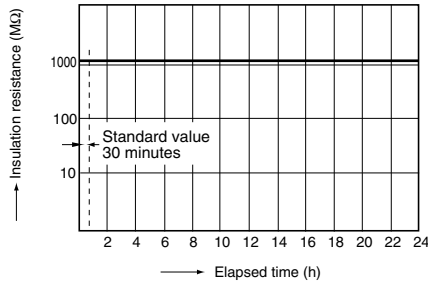

• Hydrogen sulfide exposure test

Test conditions: Concentration: 3 ppm, Temperature: 40°C
104°F, Humidity: 75% RH

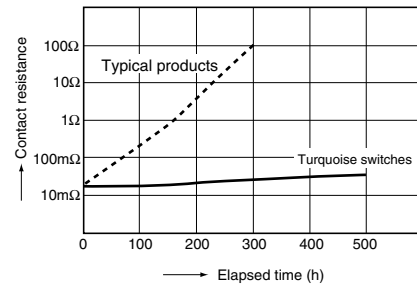

■ Oil-proof and chemical-proof characteristics

The rubber elastomer swells when exposed to oil and chemicals. The extent of swelling will vary widely depending on the type and amount of oil and chemicals.

Check with the actual oil or chemicals used.

In particular, be aware that solvents such as freon, chlorine, and toluene cannot be used.

■ Washability [ABJ (BJ) and ABS (BS)]

Do not clean the switch. Doing so can cause problems. Please contact us if cleaning is necessary.

REFERENCE

■ Dust-protected type

This type of construction prevents dust that is large enough to have an effect on operation from getting inside the unit. This construction is stipulated by protective classes against solid matter in the IEC standards (IEC60529).

The talcum powder used shall be able to pass through a square-meshed sieve the nominal wire diameter of 7 μm . The amount of talcum powder to be used is 2 kg per cubic metre of the test chamber volume. The duration of the test is 8 hours.

No damage observed after the test.

■ Immersion-protected type

This type of construction prevents any harmful effects even after the device is left underwater at a depth of 1 m for 30 minutes. This construction is stipulated by protective classes against water in the IEC standards (IEC60529).

■ IEC's IP Codes

The IEC (International Electrotechnical Commission) has defined the IP characteristic code that represents the levels of protection described in IEC standard (IEC60529).

The two numbers that follow the IP code (the characteristics numbers) indicate the suitability of this protection for all environmental conditions.

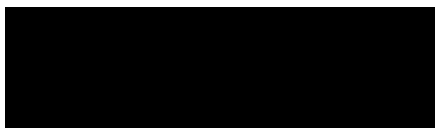

• Level of protection indicated by the 1st Characteristics number

1st Characteristics number	Protection level (IEC60529/Solid matter)
0	No protection
1	Protected against solid matter larger than 50mm
2	Protected against solid matter larger than 12mm
3	Protected against solid matter larger than 2.5mm
4	Protected against solid matter larger than 1.0mm
5	Dust-protected type Prevents dust that is large enough to have an effect on operation from getting inside the unit
6	Dust-resistant type Prevents dust from getting inside the unit

• Level of protection indicated by the 2nd Characteristics number

JIS C0920	2nd Characteristics number	Protection level (IEC60529/Liquid matter)
	0	No protection
Droplet-protected type I	1	Protected against water droplets that fall perpendicular to the unit
Droplet-protected type II	2	Protected against water droplets that fall from within 15° of perpendicular to the unit
Rain-protected type	3	Protected against water droplets that fall from within 60° of perpendicular to the unit
Splash-protected type	4	Protected against water that splashes on the unit from any direction
Spray-protected type	5	Free from adverse effects even if sprayed directly with water from any direction
Water-resistant type	6	Protected against water sprayed directly on the unit from any direction
Immersion-protected type	7	Water does not get inside of the unit when submerged in water according to the specified conditions
Underwater type	8	Unit can be used underwater

Note: Details of test conditions are the same as NECA C 0920. Please refer to them.

Technical Terminology & Cautions for Use

(Detection Switches)

TECHNICAL TERMINOLOGY

■ Detection Switches

A compact switch equipped with an enclosed micro-gap snap-action contact mechanism that makes a specified motion with a specified force to open/close a circuit, and an actuator outside the enclosure (hereinafter referred to as the switch)

■ Actuator

A part of the switch that transmits the received external force to an internal spring mechanism to move the movable contact so that the switch can be opened and closed

■ Actuator stopper

A part of the switch to limit the actuator movement in the switch operation direction

■ Rated values

Values indicating the characteristics and performance guarantee standards of the snap-action switches. The rated current and rated voltage, for instance, assume specific conditions (type of load, current, voltage, frequency, etc.).

■ Mechanical life



The service life when operated at a preset operating frequency without passing electricity through the contacts. (The life test is performed at a switching frequency of 60 times/minute and operating speed of 100 mm/second at the regular cam.)

■ Electrical life

The service life when the rated load is connected to the contact and switching operations are performed. (The life test is performed at a switching frequency of 20 times/minute and operating speed of 100 mm/second at the regular cam.)

■ Contact form

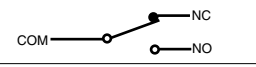
This refers to the components determining the type of application which make up the electrical input/output circuits in the contact.

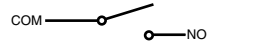
SPDT	
SPST-NC	
SPST-NO	

Terminal symbols

COM: Common terminal

NC: Normally closed terminal

NO: Normally open terminal

■ Insulation resistance

Resistance between non-continuous terminals, each terminal and other exposed metal parts and between each terminal and ground.

■ Dielectric

Threshold limit value that a high voltage can be applied to a predetermined measuring location for one minute without causing damage to the insulation.

■ Contact resistance

This indicates the electrical resistance at the contact part. Generally, this resistance includes the conductor resistance of the spring and terminal portions.

■ Vibration resistance

Malfunction vibration ... Vibration range where a closed contact does not open for longer than a specified time due to vibrations during use of the snap-action switches.

■ Shock resistance

Shock durability ... Shock range where the mechanical shocks received during snap-action switches transport and installation do not damage the parts or harm the operating characteristics. Malfunction shock ... Shock range where a closed contact does not open for longer than a specified time due to shocks during use of the snap-action switches.

OPERATING CHARACTERISTIC

■ Definition of operating characteristic

The main terminological illustrations and meanings which are used with snap-action switches are as follows.

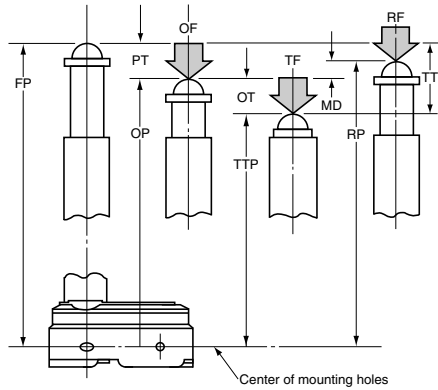

Classification	Terminology	Symbol	Unit	Varying display method	Starting current
Force	Operating Force	OF	N	Max.	The force required to cause contact snap-action. It is expressed terms of force applied to the the actuator.
	Release Force	RF	N	Min.	The force to be applied to the the actuator at the moment contact snaps back from operated position to total travel position.
	Totaltravel Force	TF	N		Force applied to an actuator required to move from an operating position to a total travel position
Movement	Pretravel	PT	mm, degree	Max.	Distance or agree of the actuator movement from free position to operating position.
	Overtravel	OT	mm, degree	Min.	The distance or degree which the actuator is permitted to travel after actuation without any damage to the switching mechanism.
	Movement Differential	MD	mm, degree	Max.	The distance or degree from operating position to release position of the actuator.
	Totaltravel	TT	mm, degree		The migration length or the move angle from the free position to total travel position of actuator
Position	Free Position	FP	mm, degree		Position of the actuator when no force is applied to.
	Operating Position	OP	mm, degree	±	The position of the actuator when the traveling contacts snaps with the fixed contact.
	Release Position	RP	mm, degree		The position of the actuator when the traveling contact snaps back from operating position to its original position.
	Total travel Position	TTP	mm, degree		The stopping position of the actuator after total travel.

TECHNICAL NOTES ON MECHANICAL CHARACTERISTICS

■ Actuation Force and Stroke

Adequate stroke setting is the key to high reliability. It is also important that adequate contact force be maintained to ensure high reliability. For a normally closed (NC) circuit, the driving mechanism should be set so that the actuator is normally in the free position. For a normally open (NO) circuit, the actuator should be pressed to 70% to 100% of the specified stroke to absorb possible errors.

If the stroke is set too close to the operating point (OP), this may cause unstable contact, and in the worst case may cause actuator damage due to inertia of the drive mechanism. It is advisable that the stroke be adjusted with the mounting plate or driving mechanism.

The figure at right shows a typical example of activation and contact forces varying with stroke. In the vicinity of the OP and RP, the contact force is diminished, causing chatter and contact bounce immediately before or after reversal. For this reason, use the switch while giving due consideration to this. This also causes the snap action switch to be sensitive to vibration or shock.

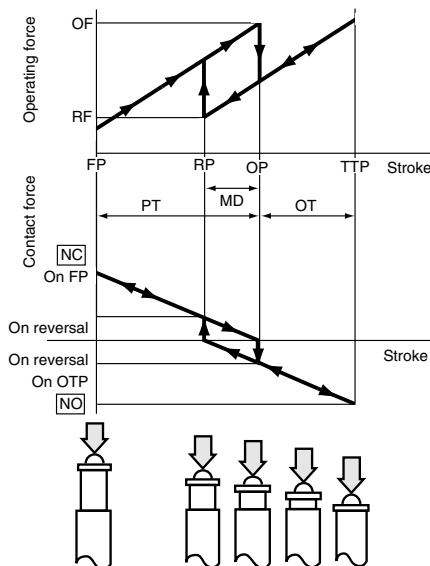

■ Changes in Operating Characteristics

Exercise design care so that malfunctions will not occur if the operating characteristics vary by as much as 20% from, rated values.

<Example>

In the OF max. 0.98N specification for FS snap-action switches, the allowable max. is $0.98 \text{ N} \times (100\%+20\%) = 1.18 \text{ N}$

In the RF min. 0.15 N min. specification the allowable min. $0.15 \text{ N} \times (100\%-20\%) = 0.12 \text{ N}$

■ Mechanical Conditions for Type Selection

Actuator type should be selected according to activation method, activation speed, activation rate, and activation frequency.

- 1) An extremely slow activation speed may cause unstable contact transfer, possibly resulting in contact failures or contact fusion.
- 2) An extremely high activation speed may cause damage to contacts or contact response failure.

■ Driving Mechanism

Use of a driving mechanism which will cause physical impact to the actuator should be avoided.

<Example>

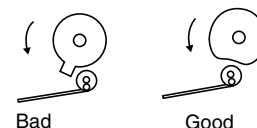

TECHNICAL NOTES ON ELECTRICAL CHARACTERISTICS

1) The snap-action switch is designed for AC operations. While it has small contact gaps and no arc absorber, it may be used for low-capacity DC operations.

Please refer to the rating of each products

2) For applications with very small switching voltage or current, choose the low-level load type (Au contact).

Small current and voltage application range (Au contact)

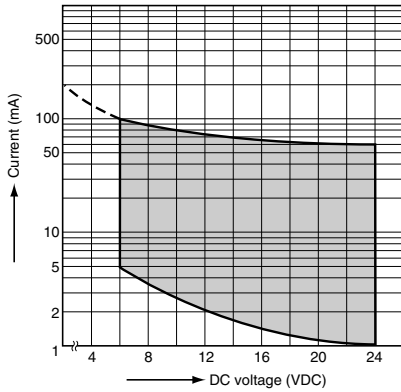

3) When selecting a contact type of a snap-action switch to be used for low-level load switching, the following should be noted. Silver contacts' surfaces are prone to be oxidized and form a sulfide film. The switch operates with no problems at the

beginning of use. However, as the contact surfaces develop films with time, the film may not be broken by the switching operation, causing a conduction failure. Therefore, please choose the Au contact type for switching a load of 0.1 A or below.

4) Application to Electronic Circuits

- The snap-action switch contacts can sustain bounce or chatter when closed. Bounce or chatter can cause noise or pulse count errors when the snap action switch is used in electronic circuits.

- If contact bounce or chatter poses problems in the vicinity of the OP and RP, use a suitable absorption network, such as a C/R network.

5) Check the surge current, normal current and surge duration.

6) Contact resistance given in performance specifications is measured with a voltage drop method using 6 to 8 V DC, 1 A (except for low-level load type). Contact resistance across COM and NC terminals is measured in the free position, while contact resistance across COM and NO terminals is measured in the total travel position.

7) To prevent contact welding failure, be sure to use a serial resistance for each capacitive load.

8) If snap-action switch operation is synchronized with the AC supply phase, this may cause: shortened electrical life, contact fusion failure, contact transfer, or other reliability problems.

CAUTIONS IN A CIRCUIT

1) Contact protection is recommended when snap-action switches are used in an inductive load circuit.

Circuit diagram	Cautions for use
	(1) $r = \text{more than } 10 \Omega$ (2) In an AC circuit Impedance of R is to be slightly smaller than impedance of r and c.
	Can be used for both AC and DC. Impedance of r is nearly equal to impedance of R. C: $0.1 \mu\text{F}$
	(1) For DC circuits only.
	Can be used for both AC and DC.

2) Do not connect the contacts on individual switches to different type or different poles of the power supply. Examples of power supply connections (connection to different poles)

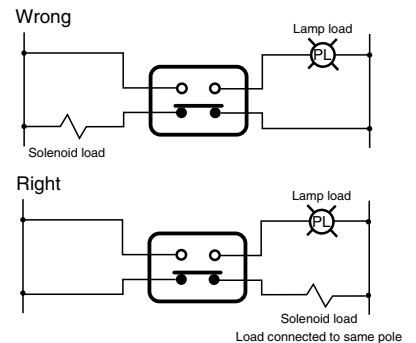

Example of wrong power supply connection (connection to different poles of power supply)
 This may lead to mixed DC and AC.

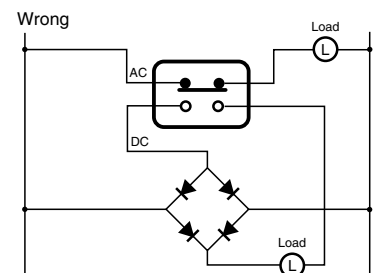

3) Avoid circuits which apply voltage between contacts. (This may lead to mixed deposition.)

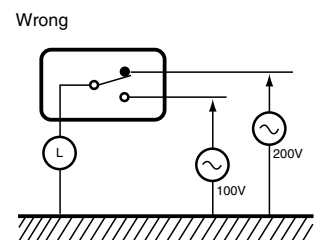

MOUNTING STATE AND ENVIRONMENT

■ Checking the insulation distance

After mounting and wiring, check the insulation distance between terminals and the ground. If the insulation distance is inadequate, mount insulating material between as required.

■ Fastening the snap-action switch body

See the Section "CAUTIONS FOR USE" for the individual switch.

■ Position adjustment with effector

- 1) The effector should be positioned so that direct force is not applied to the plunger or actuator in its free position. The operating force to the plunger should only be applied in a perpendicular direction.
- 2) Note that the use of the switch as a stopper may cause an operational problem.

■ Switch installation position

- Basically, the switch should be installed so that the object to press the switch's plunger or lever can press it down to 70 to 100% of OT of the switch. When determining the position, the tolerance of OP (Operating Position) and other factors should be taken into account.

The following describes the case where the strictest tolerance conditions are adopted.

- Example: Hinge lever type FS switch

Reference values: OP = 8.8 ± 0.8 mm
 PT = max. 2.8mm
 OT = min. 1.2mm

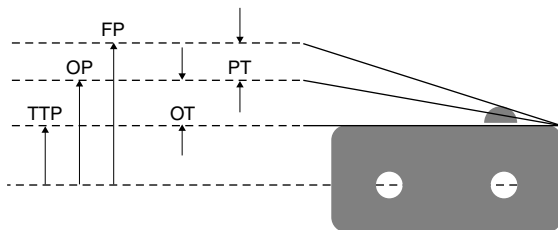

- (1) When the switch is not pressed
 The object to press the lever should not be in contact with the lever.
 For this purpose, the object should be at a distance from the switch fater than the maximum FP (Free Position) value.
 $FP \text{ max} = OP \text{ max} + PT \text{ max} = 9.6 + 2.8 = 12.4 \text{ mm max}$
 The object should be at a distance of 12.4 mm or more from the mounting hole.
- (2) Depressed position
 The plunger/lever should be pressed down to 70% or more of OT (Over Travel). Therefore, the depressed position should be calculated based on the minimum value of OP (Operating Position) and the 70 and 100% of the OT value.
 $OP \text{ min} - 70\% \text{ of OT} = 8.0 - 0.84 = 7.16 \text{ mm}$
 $OP \text{ min} - 100\% \text{ of OT} = 8.0 - 1.2 = 6.80 \text{ mm}$
 The plunger/lever should be pressed down to the position of 6.80 to 7.16 mm from the mounting hole.

■ Soldering precautions

For manual soldering, lay the terminals flat (horizontal with the ground) and quickly perform the soldering operation using a soldering iron with the appropriate heat capacity and the proper amount of solder. Take care that the flux does not flow into the switch interior by using a ventilation fan to discharge flux gas and to prevent contact of the switch body with the soldering iron tip.

Be careful not to apply force to the lead wires or the terminal portions immediately after soldering.

The temperature setting and time conditions vary depending on the product.

See the section "CAUTIONS FOR USE" for each product.

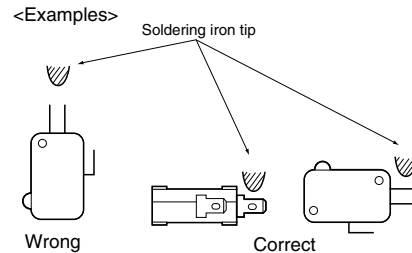

■ Avoid using in a silicon atmosphere

Avoid using organic silicon rubber, adhesives, sealing compounds, oil, grease, and wires in a silicon atmosphere.

■ Please consult us when using under the following conditions*:

- 1) Environments where hydrogen sulfide or other corrosive gases are present.
- 2) Environments where gasoline, thinner or other flammable, explosive gases are present.
- 3) Dusty environments (for non-seal type snap action switches).
- 4) The perpendicular operating speed exceeds the allowable operating speed.
- 5) Switching between different poles.
- 6) Use in environments not in the prescribed temperature or humidity range.

■ Storage precautions

To prevent discoloration due to sulfurization of the terminals (silver-plated), store the switches in a polyethylene bag or other suitable airtight container.

■ Usage, storage, and transport conditions (except turquoise switches)

During usage, storage, or transportation, avoid locations subject to direct sunlight and maintain normal temperature, humidity, and pressure conditions.

The allowable specifications for environments suitable for usage, storage, and transportation are given below.

1) Temperature: The allowable temperature range differs for each switch, so refer to the switch's individual specifications. In addition, when transporting or storing switches while they are tube packaged, there are cases when the temperature may differ from the allowable range. In this situation, be sure to consult the individual specifications.

2) Humidity: The allowable humidity range differs for each switch, so refer to the switch's individual specifications.

3) Pressure: 86 to 106 kPa

The humidity range varies with the temperature. Use within the range indicated in the graph below.

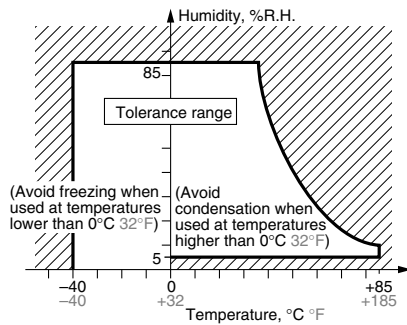

(The allowable temperature depends on the switch.)

- Condensation will occur inside the switch if there is a sudden change in ambient temperature when used in an atmosphere of high temperature and high humidity. This is particularly likely to happen when being transported by ship, so please be careful of the atmosphere when shipping. Condensation is the phenomenon whereby steam condenses to cause water droplets that adhere to the switch when an atmosphere of high temperature and humidity rapidly changes from a high to low temperature or when the switch is quickly moved from a low humidity location to one of high temperature and humidity. Please be careful because condensation can cause adverse conditions such as deterioration of insulation, coil cutoff, and rust.
- Condensation or other moisture may freeze on the switch when the temperatures is lower than 0°C 32°F. This causes problems such as sticking of movable parts or operational time lags.
- The plastic becomes brittle if the switch is exposed to a low temperature, low humidity environment for long periods of time.
- Storage for extended periods of time (including transportation periods) at high temperatures or high humidity levels or in atmospheres with organic gases or sulfide gases may cause a sulfide film or oxide film to form on the surfaces of the contacts and/or it may interfere with the functions. Check out the atmosphere in which the units are to be stored and transported.
- In terms of the packing format used, make every effort to keep the effects of moisture, organic gases and sulfide gases to the absolute minimum.

■ We reserve the right to modify without notice the materials, internal components, and other parts to improve product quality.

■ Handling precautions

When handling the switches, be careful not to drop them on the floor since this may damage them.

* Select contact sulfurization (clipping) prevention products (FS and Au-clad double layer contacts) for use with extremely small loads or an environment-resistant Turquoise switch.













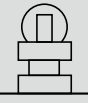

■ Others

1) Failure modes of switches include short-circuiting, open-circuiting and temperature rises. If this switch is to be used in equipment where safety is a prime consideration, examine the possible effects of these failures on the equipment concerned, and ensure safety by providing protection circuits or protection devices. In terms of the systems involved, make provision for redundancy in the design and take steps to achieve safety design.

2) The ambient operating temperature (and humidity) range quoted is the range in which the switch can be operated on a continuous basis: it does not mean that using the switch within the rating guarantees the durability performance and environment withstanding performance of the switch. For details on the performance guarantee, check the specifications of each product concerned.

Technical Terminology & Cautions for Use

■ Types of actuators

Shape	Classification	Pretravel (PT)	Overtravel (OT)	Operating Force (OF)	Vibration Shock	Features	
	Pin plunger	Small	Small	Large	Out-standing	Appropriate for linear short-stroke action. Pin plunger acts directly on snap action mechanism, enabling high-precision positioning. Amount of movement after operation is smallest among all of the actuators, however, so reliable stopper is required.	
	Spring small plunger	Small	Medium	Large	Excellent	Used in much the same way as the pin plunger, but is easier to use because the amount of movement after operation is larger.	
	Spring short plunger	Small	Medium	Large	Good	Pin plunger is short, with large plunger diameter that makes centering easier. Like small spring plunger, amount of movement after operation is large.	
	Panel attachment plunger	Small	Large	Large	Good	Secured to panel with hex or lock nut; used as manual or mechanical plunger. Amount of movement after operation is extremely large and operation point can be adjusted by changing attachment position. Can be used in combination with low-speed cam.	
	Panel attachment roller plunger	Small	Large	Large	Possible	This is the panel attachment type with a roller, and can be used with fast-moving cams and dogs..	
	Hinge lever	Large	Medium	Small	Possible	Little force required for operation. Appropriate for use with low-speed cams and dogs; has large stroke. Lever available in various shapes to fit operating unit.	
	Simulated roller lever	Large	Medium	Small	Possible	Tip of hinge lever is bent into a semi-circle, enabling use as a simple roller type.	
	Leaf lever	Large	Large	Small	Excellent	Play in lever is used to assure maximum stroke. Construction provides for space where lever is attached, for outstanding resistance to freezing.	
	Hinge roller lever	Large	Medium	Small	Possible	This is a hinge lever with a roller, and can be used with high-speed cams and dogs. The force required for pin plunger action is lighter than that of the lever, and the stroke is longer.	
	One way action hinge roller lever	Medium	Medium	Medium	Possible	This is hinge roller lever type, and can operate in relation to an operating unit from a one way direction, but the roller is bent from the opposite direction and cannot move. This can be used to prevent reverse-direction action.	
	Leaf spring	Medium	Medium	Medium	Good	This has a leaf spring with offset yield force and has a large stroke. Ideal for driving low-speed cams and cylinders. Fulcrum is fixed for high precision. To prevent leaf damage, movement after operation must be within specified value.	
	Roller leaf spring	Medium	Medium	Medium	Good	This is a leaf spring with a roller, and can be used with high-speed cams.	
	(OC reversed action groove type) Reverse-action hinge lever	Large	Small	Medium	Excellent	This is used for low-speed, low-torque cams. The lever comes in various shapes to fit the operating body.	The plunger is constantly pressed down by a coiled spring, and operating the lever induces reverse action. Because the plunger is depressed when not engaged, vibration and shock resistance are excellent. Pressing the plunger too far does not cause abnormal force to be applied to the switch mechanism, so a stable service life is assured.
	(OC reversed action groove type) Reverse-action hinge roller lever	Medium	Medium	Medium	Excellent	This is a reverse-action hinge lever with a roller and is appropriate for cam operation. Excellent resistance to vibration and impact when not engaged.	
	(OC reversed action groove type) Reverse-action hinge roller short lever	Small	Medium	Large	Excellent	This is a shorter version of the reverse-action hinge lever with a roller and has a larger action force, but is appropriate for cam operation with a short stroke. Excellent resistance to vibration and impact when not engaged.	

Please contact

Panasonic Corporation

Electromechanical Control Business Division

■ 1006, Oaza Kadoma, Kadoma-shi, Osaka 571-8506, Japan
industrial.panasonic.com/ac/e/

Panasonic[®]

©Panasonic Corporation 2017

Please contact

Panasonic Corporation

Electromechanical Control Business Division

■ 1006, Oaza Kadoma, Kadoma-shi, Osaka 571-8506, Japan
industrial.panasonic.com/ac/e/

Panasonic[®]

©Panasonic Corporation 2017